



OWNER'S MANUAL

YAMAHA

XV250D

3LV-28199-23

EAA00100

XV250D

OWNER'S MANUAL

©1991 by Yamaha Motor Co., Ltd.

1st Edition, May 1991

**All rights reserved. Any reprinting or
unauthorized use without the written
permission of Yamaha Motor Co., Ltd.
is expressly prohibited.**

Printed in Japan

INTRODUCTION

Congratulations on your purchase of the Yamaha XV250D. This model is the result of Yamaha's vast experience in the production of fine sporting, touring, and pacesetting racing machines. It represents the high degree of craftsmanship and reliability that have made Yamaha a leader in these fields.

This manual will give you an understanding of the operation, inspection, and basic maintenance of this motorcycle. If you have any questions about the operation or maintenance of your motorcycle, please consult a Yamaha dealer.

EAA10500

Particularly important information is distinguished in this manual by the following notations:



The Safety Alert Symbol means **ATTENTION! BECOME ALERT! YOUR SAFETY IS INVOLVED!**

WARNING

Failure to follow **WARNING** instructions could result in severe injury or death to the motorcycle operator, a bystander or a person inspecting or repairing the motorcycle.

CAUTION

A **CAUTION** indicates special precautions that must be taken to avoid damage to the motorcycle.

NOTE:

A **NOTE** provides key information to make procedures easier or clearer

EUU00000

NOTE: _____

This manual should be considered a permanent part of this motorcycle and should remain with it even if the motorcycle is subsequently sold

EUU13800

NOTE: _____

Yamaha continually seeks advancements in product design and quality. Therefore, while this manual contains the most current product information available at the time of printing, there may be minor discrepancies between your machine and this manual. If there is any question concerning this manual, please consult your Yamaha dealer.

EUU60100

WARNING

PLEASE READ THIS MANUAL CAREFULLY AND COMPLETELY BEFORE OPERATING THIS MOTORCYCLE.

CONTENTS

SAFETY INFORMATION	1-1	Clutch lever	5-4
LOCATION OF THE IMPORTANT LABELS.. . . .	2-1	Shift pedal	5-5
DESCRIPTION.....	3-1	Front brake lever	5-5
MOTORCYCLE IDENTIFICATION . . .	4-1	Rear brake pedal.....	5-5
Identification numbers record	4-1	Fuel tank cap	5-5
Vehicle identification number (For Australia)	4-2	Fuel cock	5-6
Frame serial number (Except for Australia)	4-2	Starter lever (CHOKE)	5-7
Engine serial number	4-3	Steering lock	5-7
CONTROL FUNCTIONS	5-1	Seat removal	5-8
Main switch	5-1	Helmet holder	5-9
Indicator lights	5-2	Rear shock absorber	5-9
Speedometer	5-2	Sidestand	5-10
Handlebar switches	5-3	Sidestand/clutch switch operation check	5-10
		PRE-OPERATION CHECKS...	6-1
		Brakes	6-3
		Brake fluid leakage	6-3
		Clutch	6-4
		Throttle grip	6-4

Engine oil... ..	6-4
Chain.. ..	6-5
Tires	6-5
Wheels	6-7
Fittings/Fasteners	6-8
Lights and signals.....	6-8
Switches	6-8
Battery.	6-8
Fuel.....	6-8

OPERATION AND IMPORTANT

RIDING POINTS	7-1
Starting and warming up	
a cold engine	7-1
Starting a warm engine	7-4
Shifting	7-4
Engine break-in	7-5
Parking.	7-6

PERIODIC MAINTENANCE AND MINOR REPAIR	8-1
Tool kit	8-1
Periodic maintenance/lubrication	8-3
Torque specifications... ..	8-5
Engine oil.....	8-6
Air filter	8-9
Carburetor adjustment.	8-11
Idle speed adjustment	8-11
Throttle cable adjustment	8-12
Valve clearance adjustment.....	8-13
Spark plug inspection.....	8-13
Front brake adjustment.....	8-14
Rear brake adjustment.	8-15
Brake light switch adjustment.....	8-17
Checking the front brake pads and rear brake shoes... ..	8-17
Inspecting the brake fluid level . . .	8-18
Brake fluid replacement.....	8-19
Clutch adjustment	8-20
Free play adjustment	8-20

Drive chain slack check	8-21
Drive chain slack adjustment.....	8-21
Drive chain lubrication	8-23
Cable inspection and lubrication..	8-24
Throttle cable and grip lubrication ...	8-24
Brake and shift pedals	8-24
Brake and clutch levers	8-24
Sidestand	8-25
Front fork inspection	8-25
Rear shock absorber adjustment	8-26
Steering inspection	8-27
Wheel bearings	8-27
Battery	8-27
Replenishing the battery fluid	8-29
Fuse replacement.....	8-30
Replacing the headlight bulb	8-30
Front wheel removal.....	8-32
Front wheel installation ...	8-33
Rear wheel removal	8-34
Rear wheel installation ..	8-35
Troubleshooting	8-36
Troubleshooting chart ..	8-37

CLEANING AND STORAGE	9-1
A. Cleaning	9-1
B. Storage.....	9-2
SPECIFICATIONS	10-1
NOISE REGULATION	11-1
WIRING DIAGRAM	

⚠ SAFETY INFORMATION

TWO-WHEELED MOTORCYCLES ARE SINGLE TRACK VEHICLES. THEIR SAFE USE AND OPERATION ARE DEPENDENT UPON THE USE OF PROPER RIDING TECHNIQUES AS WELL AS THE EXPERTISE OF THE OPERATOR.

EVERY OPERATOR SHOULD KNOW THE FOLLOWING REQUIREMENTS BEFORE RIDING.

HE OR SHE SHOULD:

- 1. OBTAIN THOROUGH INSTRUCTIONS FROM A COMPETENT SOURCE ON ALL ASPECTS OF MOTORCYCLE OPERATION.**
- 2. OBSERVE THE WARNINGS AND MAINTENANCE REQUIREMENTS IN THE OWNER'S MANUAL.**
- 3. OBTAIN QUALIFIED TRAINING IN SAFE AND PROPER RIDING TECHNIQUES.**
- 4. OBTAIN PROFESSIONAL TECHNICAL SERVICE AS INDICATED BY THE OWNER'S MANUAL AND/OR WHEN MADE NECESSARY BY MECHANICAL CONDITIONS.**

SAFE RIDING

- 1. Always make pre-operation checks. Careful checks may help prevent an accident.**
- 2. This motorcycle is designed to carry the operator and a passenger.**
- 3. The failure of motorists to detect and recognize motorcycles in traffic is the predominating cause of automobile/motorcycle accidents. Many accidents have been caused by an automobile driver who did not see the motorcycle. Making yourself conspicuous appears to be very effective in reducing the chance of this type of accident.**

Therefore:

- a. Wear a brightly colored jacket.**
 - b. Use extra caution when you approach and pass through intersections, since intersections are the most likely places for motorcycle accidents.**
 - c. Ride where other motorists can see you. Avoid riding in another motorist's "blind spot."**
- 4. Many accidents involve inexperienced operators. In fact, many operators who have been involved in accidents do not even have a current motorcycle license.**
 - a. Make sure you are qualified. Also, only lend your motorcycle to experienced operators.**

- b. Know your skills and limits. Staying within your limits may help you to avoid an accident.**
 - c. We recommend that you practice riding your motorcycle where there is no traffic until you have become thoroughly familiar with your motorcycle and all of its controls.**
- 5. Many motorcycle accidents have been caused by motorcycle operator errors. A typical error made by the operator is veering wide on a turn due to EXCESSIVE SPEED or undercornering (insufficient lean angle for the speed).**
 - a. Always obey the speed limits and never travel faster than warranted by road and traffic conditions.**
 - b. Always signal before turning or changing lanes. Make sure other motorists see you.**
- 6. The operator's and passenger's posture are important for proper control.**
 - a. The operator should keep both hands on the handlebars and both feet on the operator footrests during operation to maintain control of the motorcycle.**
 - b. The passenger should always hold on to the operator, or the seat strap or grab bar if the motorcycle is so equipped, with both hands and keep both feet on the passenger footrests.**
 - c. Never carry a passenger unless he or she can firmly place both feet on the passenger footrests.**

7. Never ride under the influence of alcohol or drugs.
8. This motorcycle is designed for on-road use only. It is not suitable for off-road use.

PROTECTIVE APPAREL

The majority of fatalities from motorcycle accidents are the result of head injuries. The use of a safety helmet is the single most critical factor in the prevention or reduction of head injuries.

1. Always wear an approved helmet.
2. Wear a face shield or goggles. Wind on your unprotected eyes could contribute to an impairment of vision which could delay seeing a hazard.
3. The use of heavy boots, jacket, trousers, gloves, etc. is effective in preventing or reducing abrasions or lacerations.
4. Never wear loose fitting clothing. It could catch on the control levers, footrests, or wheels and cause injury or accident.
5. Never touch the engine or exhaust system during or after operation. They become very hot and can cause burns. Always wear protective clothing that covers your legs, ankles, and feet.
6. A passenger should also observe the above precautions.

MODIFICATION

Modifications made to the motorcycle not approved by Yamaha, or the removal of original equipment, may render your motorcycle unsafe for use and may cause severe personal injury. Modifications may also make your motorcycle illegal to use.

LOADING AND ACCESSORIES

Adding accessories or cargo to your motorcycle can adversely affect stability and handling if the weight distribution of the machine is changed. To avoid the possibility of an accident, extreme caution should be used if adding cargo or accessories to your motorcycle. Use extra care if riding a motorcycle which has added cargo or accessories. Here are some general guidelines to follow if loading cargo or adding accessories to your motorcycle:

LOADING

The total weight of the operator, passenger, accessories and cargo must not exceed the maximum load limit of 403 lbs. (183 kg). When loading within these weight limits, keep the following in mind:

1. Cargo and accessory weight should be kept as low and close to the motorcycle as possible. Be sure to distribute the weight as evenly as possible on both sides of the machine to minimize imbalance or instability.
2. Shifting weights can create a sudden imbalance. Make sure that accessories and cargo are securely attached to the motorcycle before riding. Recheck accessory mounts and cargo restraints frequently.
3. Never attach any large or heavy items to the handlebars, front forks, or front fender. These items, including such cargo as sleeping bags, duffle bags, or tents, can create unstable handling or slow steering response.

ACCESSORIES

Genuine Yamaha accessories have been specifically designed for use on this motorcycle. Since Yamaha cannot test all other accessories which may be available, you must personally be responsible for the proper selection, installation and use of non-Yamaha accessories. You should use extreme caution when selecting and installing any accessories.

Keep in mind these guidelines for mounting accessories in addition to those provided under "LOADING."

- 1. Never install accessories or carry cargo that would impair the performance of your motorcycle. Carefully inspect the accessory before using it to make sure it does not in any way reduce ground clearance or cornering clearance, limit suspension travel, steering travel or control operation, or obscure lights or reflectors.**
 - a. Accessories fitted to the handlebar or the front fork area can create instability due to improper weight distribution or aerodynamic changes. If accessories are added to the handlebar or front fork area, they must be as lightweight as possible and should be kept to a minimum.**
 - b. Bulky or large accessories may seriously affect the stability of the motorcycle due to aerodynamic effects. Wind may attempt to lift the motorcycle, or the motorcycle may become unstable in cross winds. These accessories may also cause instability when being passed by or passing large vehicle.**
 - c. Certain accessories can displace the operator from his or her normal riding position. This improper position limits the freedom of movement of the operator and may limit control ability. Therefore such accessories are not recommended.**
- 2. Caution must be used if adding electrical accessories. If these accessories exceed the capacity of the motorcycle's electrical system, an electric failure could result, which could cause a dangerous loss of lights or engine power.**

GASOLINE AND EXHAUST GAS

- 1. GASOLINE IS HIGHLY FLAMMABLE:**
 - a. Always turn off the engine when refueling.**
 - b. Take care not to spill any gasoline on the engine or exhaust pipe(s)/muffler(s) when refueling.**
 - c. Never refuel while smoking or in the vicinity of an open flame.**
- 2. Never start the engine or let it run for any length of time in a closed area. The exhaust fumes are poisonous and may cause loss of consciousness and death within a short time. Always operate your motorcycle in an area that has adequate ventilation.**
- 3. Always turn off the engine before leaving the motorcycle unattended and remove the ignition key. When parking the motorcycle, note the following:**
 - a. The engine and exhaust pipe(s)/muffler(s) may be hot. Park the motorcycle in a place where pedestrians or children are not likely to touch these hot areas.**
 - b. Do not park the motorcycle on a slope or soft ground; the motorcycle may fall over.**
 - c. Do not park the motorcycle near a flammable source, e.g. a kerosene heater, or near an open flame. The motorcycle could catch fire.**

- 4. When transporting the motorcycle in another vehicle, be sure it is kept upright and that the fuel cock(s) is turned to "ON" or "RES" (for vacuum type)/"OFF" (for manual type). If it should lean over, gasoline may leak out of the carburetor or fuel tank.**
- 5. If you should swallow any gasoline, inhale a lot of gasoline vapor, or allow gasoline to get in your eye(s), see your doctor immediately. If any gasoline spills on your skin or clothing, immediately wash it off with soap and water and change your clothes.**

LOCATION OF THE IMPORTANT LABELS

Please read the following labels carefully before operating this motorcycle.

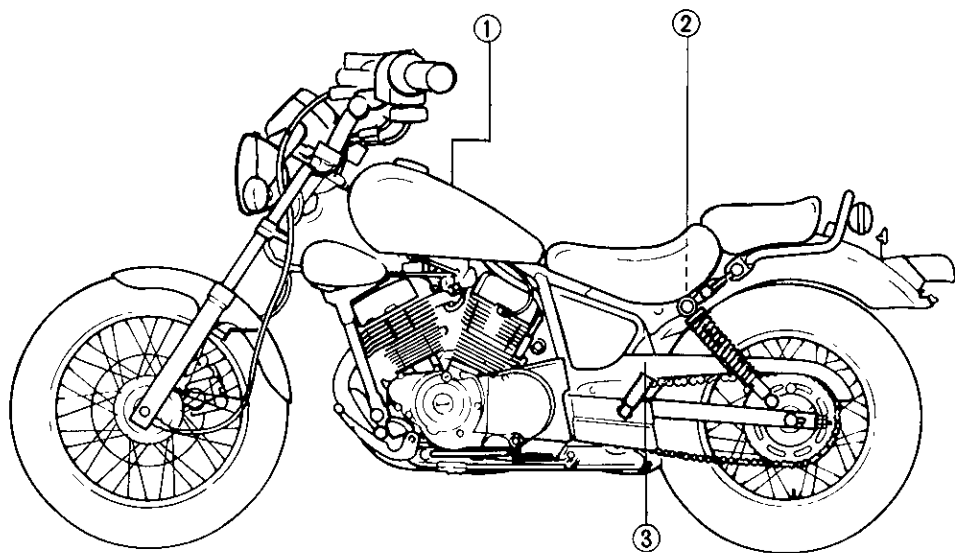

①

⚠ WARNING

- **BEFORE YOU OPERATE THIS VEHICLE, READ THE OWNER'S MANUAL AND ALL LABELS.**
- **ALWAYS WEAR AN APPROVED MOTORCYCLE HELMET, eye protection, and protective clothing**

YAMAHA

3MX-2118K-00

②

CAUTION

- Read owner's manual before servicing battery
- Electrolyte will damage metal parts or paint
If electrolyte spills, wash area with fresh water immediately
- Be sure to connect breather hose after installing battery

YAMAHA

3JL-28177-00

③

TIRE INFORMATION

Cold tire normal pressure should be set as follows

- Up to 90kg (198 lbs) load

FRONT 175 kPa, {1 75 kgf/cm²}, 25 psi

REAR 200 kPa, {2 00 kgf/cm²}, 29 psi

- 90kg (198 lbs) ~ maximum load

FRONT 200 kPa, {2 00 kgf/cm²}, 29 psi

REAR 225 kPa, {2 25 kgf/cm²}, 33 psi

YAMAHA

3CK-21668-00

DESCRIPTION

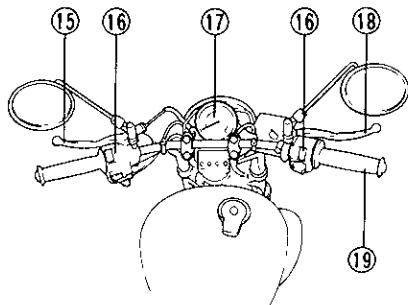
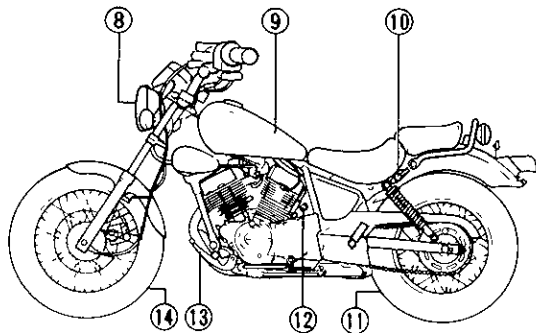
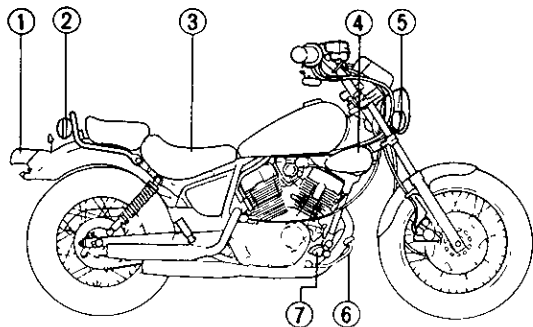

- | | |
|-----------------------|---------------------|
| 1 Tail/brake light | 11 Rear wheel |
| 2 Rear flasher light | 12 Main switch |
| 3 Seat | 13 Shift pedal |
| 4 Air filter | 14 Front wheel |
| 5 Front flasher light | 15 Clutch lever |
| 6 Brake pedal | 16 Handfebar switch |
| 7 Footrest | 17 Speedometer |
| 8 Headlight | 18 Brake lever |
| 9 Fuel tank | 19 Throttle grip |
| 10 Helmet holder | |

MOTORCYCLE IDENTIFICATION

Identification numbers record

1. KEY IDENTIFICATION NUMBER.

2. VEHICLE IDENTIFICATION NUMBER. FRAME SERIAL NUMBER

3. ENGINE SERIAL NUMBER.

Your key identification number is stamped on your key as shown in the following illustration. Record this number in the space provided for reference if you need a new key.

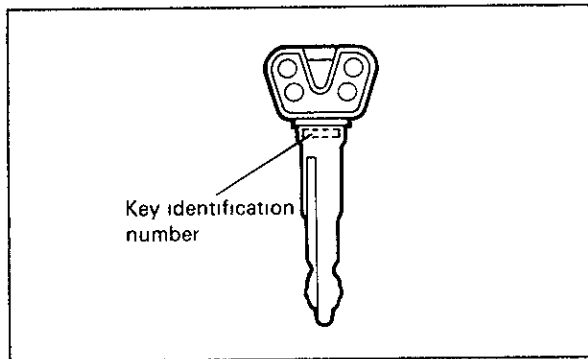

Record your vehicle identification number (or frame serial number) and engine serial number in the spaces provided to assist you in ordering spare parts from your Yamaha dealer or for reference in case your vehicle is stolen.

EAA80000

Vehicle identification number (For Australia)

The vehicle identification number is stamped into the steering head pipe.

EUU00400

NOTE:

The vehicle identification number is used to identify your motorcycle and may be used to register your motorcycle with the licensing authority in your state.

EAA60200

Frame serial number (Except for Australia)

The frame serial number is stamped into the right side of the steering head pipe.

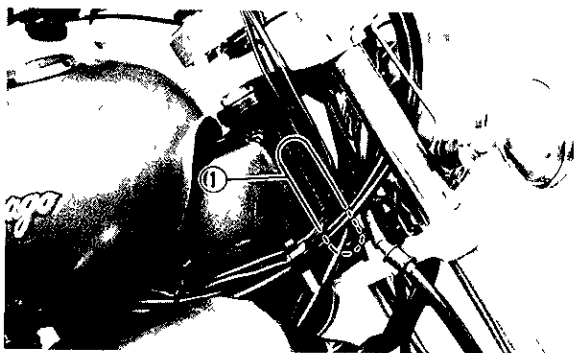

- 1 Frame serial number (Except for Australia)
- 1 Vehicle identification number (For Australia)

Engine serial number

The engine serial number is stamped into the left side of the engine

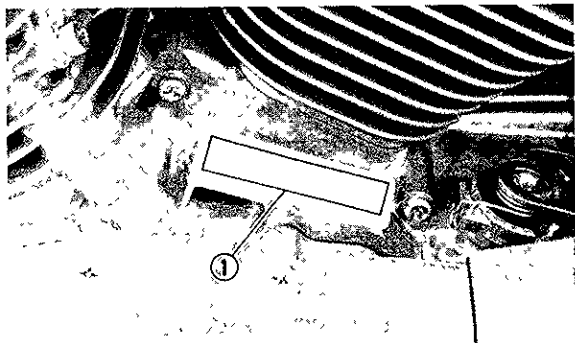

1 Engine serial number

NOTE:

The first three digits of these numbers are for model identification, the remaining digits are the unit production number. Keep a record of these numbers for reference when ordering parts from a Yamaha dealer.

EAB00000

CONTROL FUNCTIONS

EAB00100

Main switch

The main switch controls the ignition and lighting systems. Its operation is described below

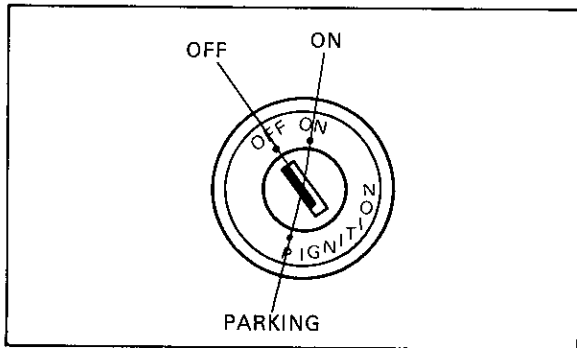

EAB00500

ON:

Electrical circuits are switched on. The engine can be started. The key cannot be removed in this position.

EAB00600

OFF:

All electrical circuits are switched off. The key can be removed in this position.

EAB02000

PARKING:

The taillight and auxiliary light come on but all other circuits are off. With the key at "OFF", push it into the main switch, turn it counterclockwise to "PARKING", and remove it. To cancel the parking, turn the key clockwise

EUU08800

NOTE:

Always turn the main switch to "OFF" and remove the key when the motorcycle is unattended.

Indicator lights

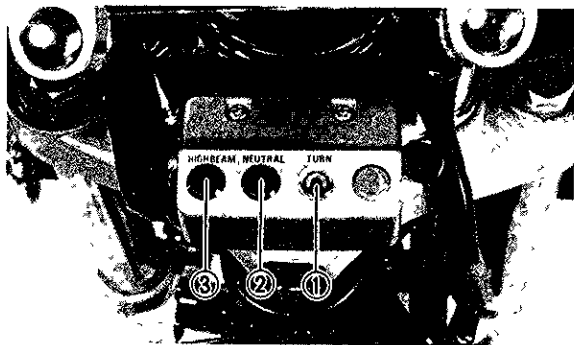

- 1 "TURN" indicator light
- 2 "NEUTRAL" indicator light
- 3 "HIGH BEAM" indicator light

"TURN" indicator light (orange):

This indicator flashes when the turn switch is "ON"

"NEUTRAL" indicator light (green):

This indicator comes on when the transmission is in neutral.

"HIGH BEAM" indicator light (blue):

This indicator comes on when the headlight high beam is used.

Speedometer

The odometer and trip odometer are built into the speedometer. The trip odometer can be reset to "0" with the reset knob. Use the odometer to estimate how far you can ride on a tank of fuel before going to "RESERVE". This information will enable you to plan fuel stops in the future.

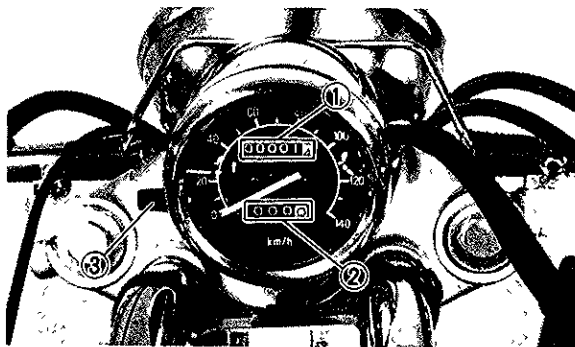

- 1 Odometer
- 2 Trip odometer
- 3 Reset knob

Handlebar switches:

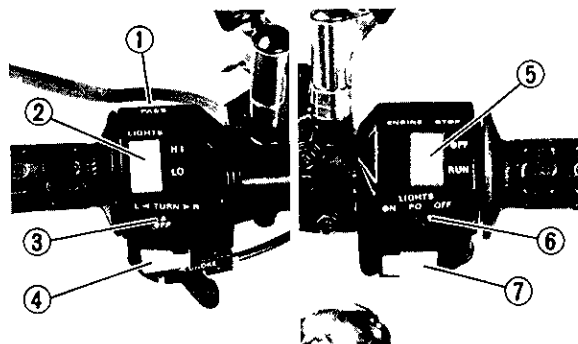

- | | |
|----------------------------|------------------------|
| 1 "PASS" switch | 5 "ENGINE STOP" switch |
| 2 "LIGHTS" (Dimmer) switch | 6 "LIGHTS" switch |
| 3 "TURN" signal switch | 7 "START" switch |
| 4 "HORN" switch | |

"PASS" switch

When you are passing a vehicle ahead, the passing light switch should be depressed so that the headlight gives a signal to the driver of the other vehicle.

"LIGHTS" (Dimmer) switch

Turn the switch to "HI" for the high beam and to "LO" for the low beam.

"TURN" signal switch

This model is equipped with self-cancelling turn signals. To signal a right-hand turn, push the switch to the right, to signal a left-hand turn, push the switch to the left. Once the switch is released it will return to the center position. To cancel the signal, push the switch in after it has returned to the center position. If the switch is not cancelled by hand, it will self-cancel after the motorcycle has travelled for about 10 seconds or approximately 150 meters (490 feet) whichever is greater. The self-cancelling mechanism only operates when the motorcycle is moving, thus the signal will not self-cancel while you are stopped at an intersection.

EAB60200

"HORN" switch

Press the switch to sound the horn.

EAB61200

"LIGHTS" switch

Turn the light switch to "ON" to turn on the headlight, taillight, and meter lights. Turn the light switch to "PO" to turn on the auxiliary light, taillight, and meter lights.

EAB60900

"ENGINE STOP" switch

The engine stop switch is a safety device for use in an emergency such as when the motorcycle overturns or when trouble occurs in the throttle system. The engine will not run when the engine stop switch is turned to "OFF". In case of emergency, turn the switch to "OFF".

EAB60700

"START" switch

To start the engine, push the starter

EUU30700

CAUTION

See starting instructions prior to starting the engine.

EAB70000

Clutch lever

The clutch lever is located on the left handlebar, and the starting circuit cut-off switch is incorporated in the clutch lever holder. Pull the clutch lever to the handlebar to disengage the clutch, and release the lever to engage the clutch. The lever should be pulled rapidly and released slowly for smooth starts. (Refer to the engine starting procedures for a description of the starting circuit cut-off switch.)

EAB80000

Shift pedal

The gear ratios of the constant-mesh 5-speed transmission are ideally spaced. The gears can be shifted by using the shift pedal on the left side of the engine

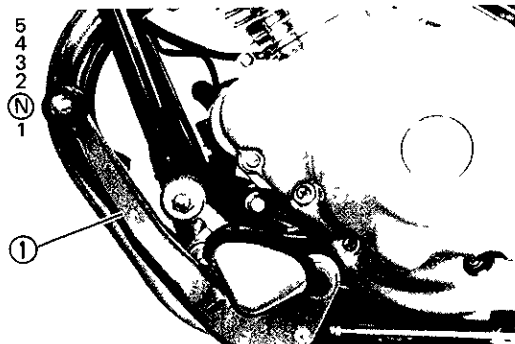

1 Shift pedal

N Neutral

EAB90000

Front brake lever

The front brake lever is located on the right handlebar. Pull it toward the handlebar to activate the front brake

EAB90100

Rear brake pedal

The rear brake pedal is on the right side of the motorcycle. Press down on the brake pedal to activate the rear brake.

EAC00100

Fuel tank cap

TO OPEN.

Insert the key and turn clockwise 1/4 turn. The lock will be released and the cap can be opened.

TO CLOSE.

Push the tank cap into position with the key inserted. To remove the key, turn it counter-clockwise to the original position

EUU01200

NOTE: _____

This tank cap cannot be closed unless the key is in the lock. The key cannot be removed if the cap is not locked properly.

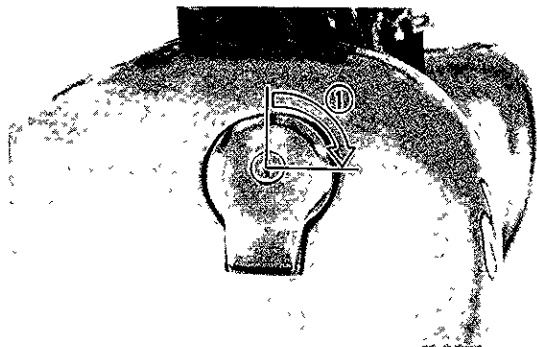

1 Open

EAC10200

Fuel cock

The negative pressure fuel cock supplies fuel from the tank to the carburetors and also filters the fuel. The fuel cock has the following three positions.

ON: With the lever in this position, fuel flows if the engine is running but stops if the engine is not running

RES: This indicates reserve. If you run out of fuel while riding, move the lever to "PRI", start the engine, then switch to "RES". FILL THE TANK AT THE FIRST OPPORTUNITY. BE SURE TO SET THE LEVER TO "ON" AFTER REFUELLING.

EUU01400

NOTE: _____

The fuel cock operates on vacuum from the engine when set at "ON" or "RES." If the line connecting the cock to the carburetor intake manifold is not connected or has a leak, the cock will not function properly.

PRI: This indicates prime. With the lever in this position, fuel flows whether the engine is running or not. If the fuel tank is completely empty, refill the tank, prime the carburetor in this position, and then switch to "ON" after starting the engine.

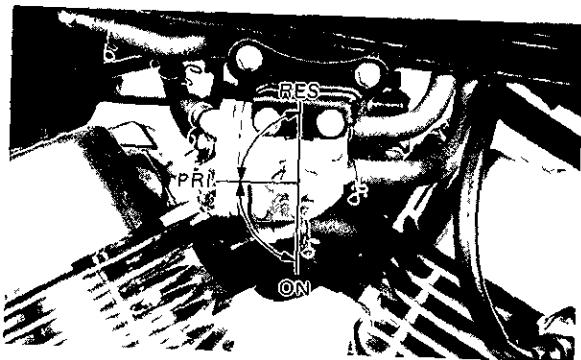

EAC20100

Starter lever (CHOKE)

The starter lever is located on the left handlebar. Starting a cold engine requires a richer fuel mixture. In such a case, turn the starter lever to the left. After the engine is warm, turn the lever to its original position.

EUU01600

NOTE:

Refer to "Starting and warming up a cold engine" for proper operation.

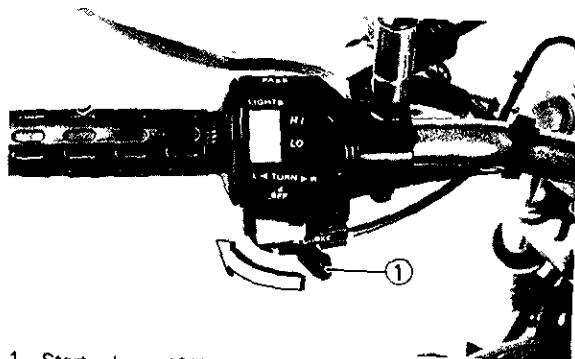

1 Starter lever (CHOKE)

EAC30200

Steering lock

To lock the steering, turn the handlebars all the way to the right, and insert the key into the steering lock. Turn the key 1/8 turn counterclockwise, push it in, then turn it 1/8 turn clockwise. After checking to see that the lock is engaged, remove the key from the lock. To release the lock, reverse the above procedure.

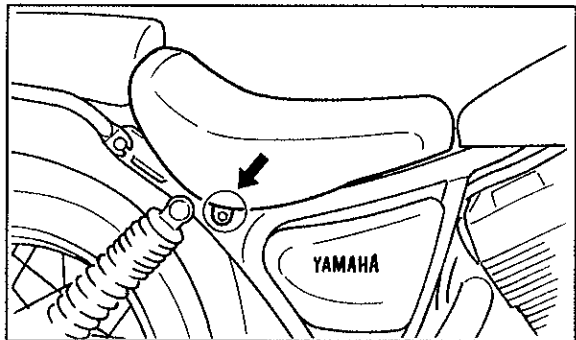
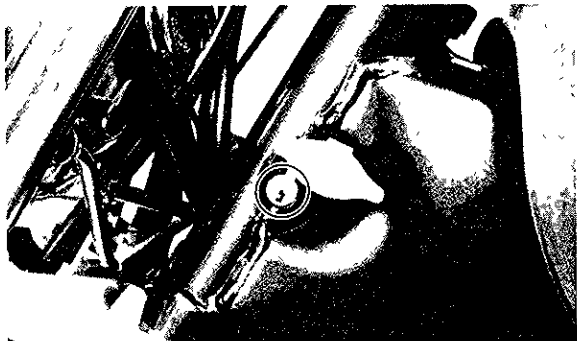

EAC41500

Seat removal

To remove the rider seat, remove the two bolts. When reinstalling the rider seat, insert the lobe(s) on the seat front into the receptacle on the frame, then tighten the bolts.

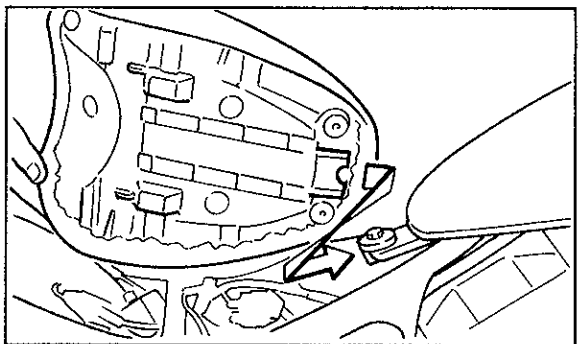

Helmet holder

To open the helmet holder, insert the key in the lock and turn it as shown. To lock the helmet holder, replace the holder in its original position.

EUU61500

⚠ WARNING

Never ride with a helmet in the helmet holder. It could interfere with rear wheel movement, causing loss of control and possibly an accident.

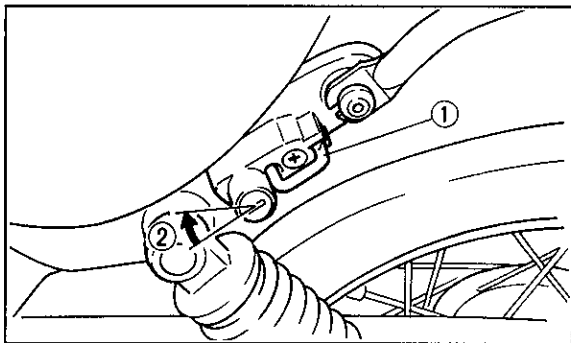

1 Helmet holder

2 Open

Rear shock absorber

The spring preload of the rear shock absorber can be adjusted to suit the motorcycle's load (ex. optional accessories etc) and riding conditions. Refer to page 8-26 for proper adjustment procedures.

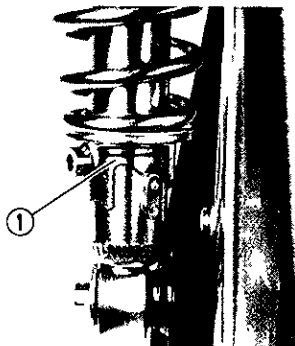

1 Spring preload adjuster

Sidestand

This model is equipped with an ignition circuit cut-off system. The motorcycle must not be ridden when the sidestand is down. The sidestand is located on the left side of the frame (Refer to page 7-1 for an explanation of this system.)

EUU68900

⚠ WARNING

This motorcycle must not be operated with the sidestand in the down position. If the stand is not properly retracted, it could contact the ground and distract the operator, resulting in a possible loss of control. Yamaha has designed into this motorcycle a lockout system to assist the operator in fulfilling the responsibility of retracting the sidestand. Please check carefully the operating instructions listed below and if there is any indication of a mal-

function, you must return the motorcycle to a Yamaha dealer immediately for repair.

EAD30800

Sidestand/clutch switch operation check

Check the operation of the sidestand switch and clutch switch against the information below.

CD3-01

TURN MAIN SWITCH TO "ON" AND ENGINE STOP SWITCH TO "RUN".

TRANSMISSION IS IN GEAR AND SIDESTAND IS UP.

PULL IN CLUTCH LEVER AND PUSH STARTER SWITCH

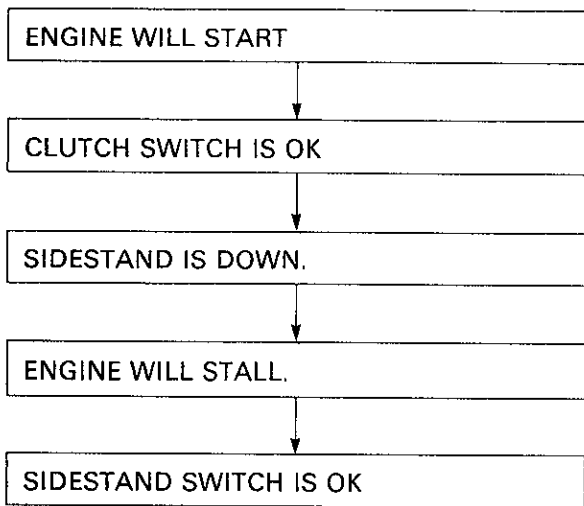

EUU69100

⚠ WARNING

If improper operation is noted, consult a Yamaha dealer immediately.

PRE-OPERATION CHECKS

Before using this motorcycle, check the following points:

Item	Routine	Page
Front brake	Check operation, free play, fluid level, and fluid leakage Top-up with DOT #4 (or #3) brake fluid if necessary	6-3~6-4, 8-14~8-20
Rear brake	Check operation, condition and free play Adjust if necessary.	
Clutch	Check operation, condition and free play Adjust if necessary	6-4, 8-20
Throttle grip/Housing	Check for smooth operation Lubricate/Adjust if necessary	6-4, 8-12, 8-24
Engine oil	Check oil level/add oil as required	6-4, 8-6~8-8
Drive chain	Check chain slack and condition Adjust if necessary	6-5, 8-21~8-23
Wheels/Tires	Check tire pressure, wear, damage and spoke tightness	6-5~6-7, 8-32~8-36
Control/Meter cables	Check for smooth operation Lubricate if necessary	8-24
Brake and shift pedal shafts	Check for smooth operation. Lubricate if necessary.	8-24
Brake and clutch lever pivots	Check for smooth operation Lubricate if necessary	8-24
Sidestand pivot	Check for smooth operation Lubricate if necessary	8-25
Fittings/fasteners	Check all chassis fittings and fasteners Tighten/Adjust, if necessary	6-8, 8-5
Fuel tank	Check fuel level/top-up as required	6-8~6-9
Lights and signals	Check for proper operation	6-8, 8-30~8-32
Battery	Check fluid level, top-up with distilled water if necessary	6-8, 8-27~8-30

NOTE:

Pre-operation checks should be made each time the motorcycle is used. Such an inspection can be thoroughly accomplished in a very short time, and the added safety it assures is more than worth the time involved.

 WARNING

If any item in the Pre-Operation Check is not working properly, have it inspected and repaired before operating the motorcycle.

Brakes (See page 8-14 for details)

1. Brake lever and brake pedal

Check for correct free play in the front brake lever and rear brake pedal. Make sure they are working properly. Check the brakes at low speed shortly after starting out. If the free play is incorrect, adjust it.

⚠ WARNING

A soft, spongy feeling in the brake lever indicates a failure in the brake system. Do not operate the motorcycle until the failure in the brake system is corrected. Ask a Yamaha dealer for immediate repairs. A soft, spongy feeling could indicate a hazardous condition in the brake system.

2. Brake fluid

Check the brake fluid level. Add fluid if necessary.

Recommended brake fluid. DOT #4

NOTE: _____

If DOT #4 is not available, #3 can be used.

3. Check the disc pads.

Refer to page 8-17.

4. Check the brake shoes.

Refer to page 8-17.

NOTE: _____

When this brake service is necessary, ask a Yamaha dealer.

Brake fluid leakage (Front)

Apply the brake for a few minutes. Check to see if any brake fluid leaks out from the pipe joints or the master cylinder.

⚠ WARNING

If brake fluid leakage is found, ask a Yamaha dealer for immediate repairs. Such leakage could indicate a hazardous condition.

Clutch (See page 8-20 for details)

Check the free play in the clutch lever, and make sure the lever operates properly. If the free play is incorrect, adjust it.

Throttle grip (See page 8-12 for details)

Turn the throttle grip to see if it operates properly, and check the free play. Make sure the grip returns by spring force when released. Ask a Yamaha dealer to make any necessary adjustments.

Engine oil (See page 8-6 for details)

Make sure the engine oil is at the specified level. Add oil as necessary.

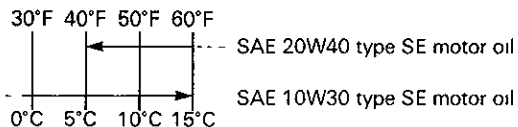
Recommended oil**Oil quantity.**

Total amount:

1.8 L (1.6 Imp qt, 1.9 US qt)

Periodic oil change

1.4 L (1.2 Imp qt, 1.5 US qt)

With oil filter replacement

1.6 L (1.4 Imp qt, 1.7 US qt)

NOTE:

Recommended engine oil classification, API Service "SE", "SF" type or equivalent (e.g. "SF-SE", "SF-SE-CC", "SF-SE-SD" etc.).

EAE50000

Chain (See page 8-21 for details)

Check the general condition of the chain and check the chain slack before every ride. Lubricate and adjust the chain as necessary.

EAE90900

Tires

To ensure maximum performance, long service, and safe operation, note the following.

1. Tire air pressure

Always check and adjust the tire pressure before operating the motorcycle.

EUU67500

WARNING

Tire inflation pressure should be checked and adjusted when the temperature of the tire equals the ambient air temperature. Tire inflation pressure must be adjusted according to total weight of cargo, rider, passenger, and accessories (fairing, saddlebags, etc. if approved for this model), and vehicle speed.

CE9-03

Basic weight With oil and full fuel tank	147 kg (324 lb)	
Maximum load*	183 kg (403 lb)	
Cold tire pressure	Front	Rear
	175 kPa (1.75 kg/cm ² , 25 psi)	200 kPa (2.0 kg/cm ² , 29 psi)
90 kg (198 lb) ~ Maximum load*	200 kPa (2.0 kg/cm ² , 29 psi)	225 kPa (2.25 kg/cm ² , 33 psi)

* Load is the total weight of cargo, rider, passenger, and accessories

EUU67700

WARNING

Proper loading of your motorcycle is important for the handling, braking, and other performance and safety characteristics of your motorcycle. Do not carry loosely packed items that can shift. Securely pack your heaviest items close to the center of the mo-

torcycle, and distribute the weight evenly from side to side. Properly adjust the suspension for your load, and check the condition and pressure of your tires. **NEVER OVERLOAD YOUR MOTORCYCLE.** Make sure the total weight of the cargo, rider, passenger, and accessories (fairing, saddlebags, etc. if approved for this model) does not exceed the maximum load of the motorcycle. Operation of an overloaded motorcycle could cause tire damage, an accident, or even injury.

2. Tire inspection

Always check the tires before operating the motorcycle. If a tire tread shows crosswise lines (minimum tread depth), if the tire has a nail or glass fragments in it, or if the side wall is cracked, contact a Yamaha dealer immediately and have the tire replaced.

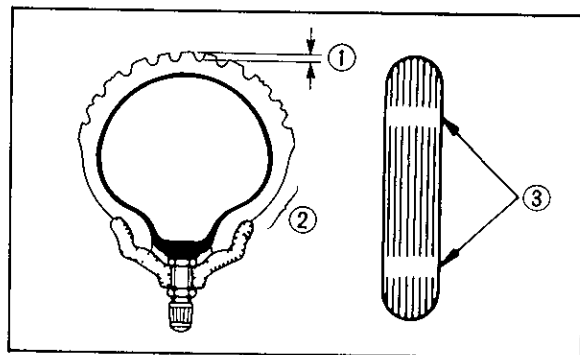

1 Tread depth

2 Side wall

3 Wear indicator

CE9-02

FRONT

Manufacture	Size	Type
IRC	3 00-18 4PR	NF27

REAR

Manufacture	Size	Type
IRC	130/90-15 M/C 66P	NR31

Minimum tire tread depth (front and rear)	1 0 mm (0 04 in)
---	------------------

⚠ WARNING

- 1. It is dangerous to ride with a worn-out tire. When a tire tread begins to show lines, have a Yamaha dealer replace the tire immediately. Brakes, tires, and related wheel parts replacement should be left to a Yamaha Service Technician.**
 - 2. Patching a punctured tube is not recommended. If it is absolutely necessary to do so, use great care and replace the tube as soon as possible with a good quality replacement.**
-

Wheels

To ensure maximum performance, long service, and safe operation, note the following.

- 1. Always inspect the wheels before a ride. Check for cracks, bends, or warpage of the wheel; be sure the spokes are tight and undamaged. If any abnormal condition exists in a wheel, consult a Yamaha dealer. Do not attempt even small repairs to the wheel. If a wheel is deformed or cracked, it must be replaced.**
- 2. Tires and wheels should be balanced whenever either one is changed or replaced. Failure to have a wheel balanced can result in poor performance, adverse handling characteristics, and shortened tire life**
- 3. After installing a tire, ride conservatively to allow the tire to seat itself on the rim properly. Failure to allow proper seating may cause tire failure, resulting in damage to the motorcycle and injury to the rider.**

EAE85000

Fittings/Fasteners

Always check the tightness of chassis fittings and fasteners before a ride. Use the chart on page 8-5 to find the correct torque.

EAE70000

Lights and signals

Check the headlight, flasher lights, taillight, brake light, meter lights, and all the indicator lights to make sure they are in working condition.

EAE70700

Switches

Check the operation of the headlight switch, turn switch, brake light switch, horn switch, starter switch, main switch, etc

EAE70500

Battery (See page 8-27 for details)

Check the fluid level and top-up if necessary
Use only distilled water if refilling is necessary.

EAE80000

Fuel

Make sure there is sufficient fuel in the tank.

EUU61000

⚠ WARNING

Do not overfill the fuel tank. Avoid spilling fuel on the hot engine. Do not fill the fuel tank above the bottom of the filler tube as shown in the illustration or it may overflow when the fuel heats up later and expands.

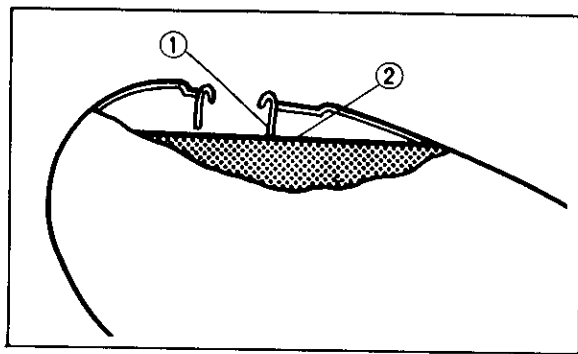

1 Filler tube

2 Fuel level

CAUTION

Always wipe off spilled fuel immediately with a dry and clean soft cloth, etc. Fuel may erode painted surfaces or plastic parts.

Recommended fuel Regular gasoline

For Australia: Unleaded fuel only

Fuel tank capacity:

Total:

9.5 L(2.1 Imp gal, 2.5 US gal)

Reserve:

2.6 L(0.6 Imp gal, 0.7 US gal)

OPERATION AND IMPORTANT RIDING POINTS

EUU67200

WARNING

Before riding this motorcycle, become thoroughly familiar with all operating controls and their functions. Consult a Yamaha dealer regarding any control or function that you do not thoroughly understand.

EUU62800

WARNING

1. Never start your engine or let it run for any length of time in a closed area. The exhaust fumes are poisonous and can cause loss of consciousness and death within a short time. Always operate your motorcycle in an area with adequate ventilation.

2. Before starting out, always be sure the sidestand is up. Failure to retract the sidestand completely can result in a serious accident when you try to turn a corner.

Starting and warming up a cold engine

EUU02800

NOTE:

This motorcycle is equipped with a starting and an ignition circuit cut-off switch

1. The engine can be started only under the following conditions
 - a. The transmission is in neutral
 - b. The sidestand is up, the transmission is in gear, and the clutch is disengaged
2. The motorcycle must not be ridden when the sidestand is down.

⚠ WARNING

Before going through the following steps, check the function of the side-stand switch and clutch switch. (Refer to page 5-10.)

CF1-01

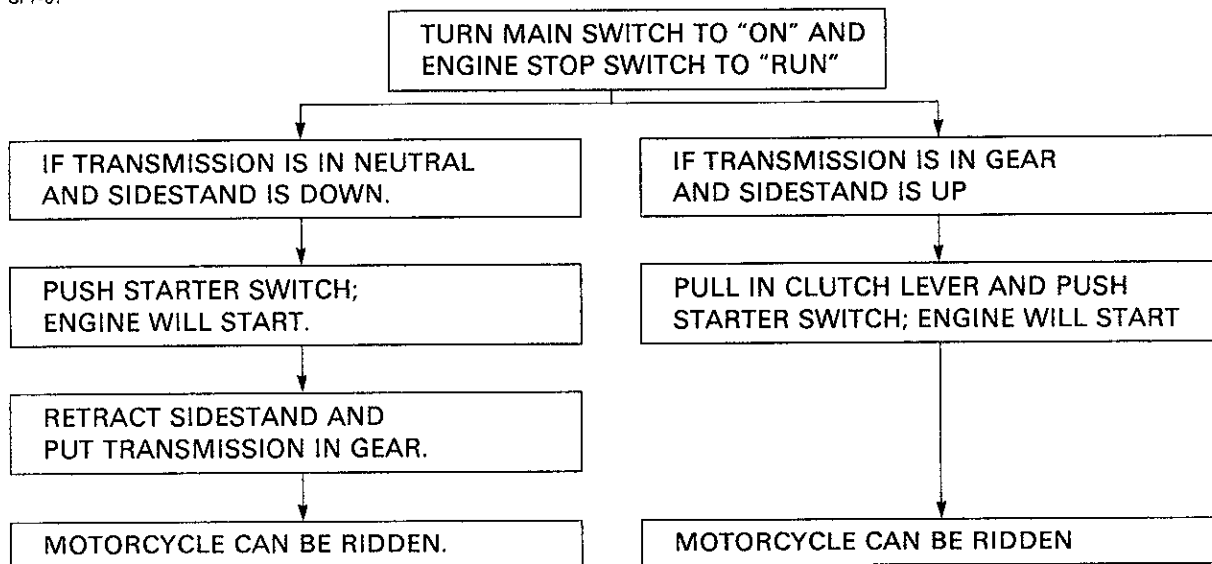

1. Turn the fuel cock to "ON."
2. Turn the ignition key to "ON" and the engine stop switch to "RUN "
- 3 Shift transmission into neutral

EUU03000

NOTE: _____

When the transmission is in neutral, the neutral indicator light (green) should be on. If the light does not come on, ask a Yamaha dealer to inspect it.

- 4 Fully open the starter (CHOKE) and completely close the throttle grip.
- 5 Start the engine by pushing the starter switch.

EUU02500

NOTE: _____

If the engine fails to start, release the starter switch, wait a few seconds, then try again. Each attempt should be as short as possible to preserve the battery. Do not crank the engine more than 10 seconds on any one attempt.

6. After starting the engine, turn back the starter (CHOKE) to warming up position (about halfway)

EUU02600

NOTE: _____

For maximum engine life, always warm up the engine before starting off. Never accelerate hard with a cold engine!

- 7 After warming up the engine, turn off the starter completely

EUU02700

NOTE: _____

The engine is warm when it responds normally to the throttle with the starter turned off

Starting a warm engine

The starter (CHOKE) is not required when the engine is warm

CAUTION:

See "Break-in section" prior to operating the motorcycle for the first time.

Shifting

The transmission lets you control the amount of power you have available at a given speed for starting, accelerating, climbing hills, etc. The use of the shift pedal is shown in the illustration (Page 5-5)

To shift into NEUTRAL, depress the shift pedal repeatedly until it reaches the end of its travel (you will feel a stop when you are in first gear), then raise the pedal slightly

CAUTION:

1. Do not coast for long periods with the engine off, and do not tow the motorcycle a long distance. Even with gears in neutral, the transmission is only properly lubricated when the engine is running. Inadequate lubrication may damage the transmission.
2. Always use the clutch when changing gears. The engine, transmission, and driveline are not designed to withstand the shock of forced shifting and can be damaged by shifting without the clutch.

Engine break-in

There is never a more important period in the life of your motorcycle than the period between zero and 1,000 km (600 mi). For this reason we ask that you carefully read the following material. Because the engine is brand new, you must not put an excessive load on it for the first 1,000 km (600 mi). The various parts in the engine wear and polish themselves to the correct operating clearances. During this period, prolonged full throttle operation, or any condition which might result in excessive heating of the engine, must be avoided.

- 1 0 ~ 150 km (0 ~ 100 mi):
Avoid operation above 1/3 throttle. Stop the engine and let it cool for 5 to 10 minutes after every hour of operation. Vary the speed of the motorcycle from time to time. Do not operate it at one set throttle position.

- 2 150 ~ 500 km (100 ~ 300 mi):
Avoid prolonged operation above 1/2 throttle. Rev the motorcycle freely through the gears, but do not use full throttle at any time.
3. 500 ~ 1,000 km (300 ~ 600 mi):
Avoid cruising speeds in excess of 3/4 throttle

CAUTION

After 1,000 km (600 mi) of operation, be sure to replace the engine oil and oil filter element.

4. 1,000 km (600 mi) and beyond:
Avoid prolonged full throttle operation
Vary speeds occasionally.

CAUTION:

If any engine trouble should occur during the break-in period, consult a Yamaha dealer immediately.

Parking

When parking the motorcycle, stop the engine and remove the ignition key.

! WARNING

The muffler and exhaust pipe are hot. Park the motorcycle in a place where pedestrians or children are not likely to touch the motorcycle. Do not park the motorcycle on a slope or soft ground; the motorcycle may overturn.

PERIODIC MAINTENANCE AND MINOR REPAIR

Periodic inspection, adjustment and lubrication will keep your motorcycle in the safest and most efficient condition possible. Safety is an obligation of the motorcycle owner. The maintenance and lubrication schedule chart should be considered strictly as a guide to general maintenance and lubrication intervals. **YOU MUST TAKE INTO CONSIDERATION THAT WEATHER, TERRAIN, GEOGRAPHICAL LOCATIONS, AND A VARIETY OF INDIVIDUAL USES ALL TEND TO DEMAND THAT EACH OWNER ALTER THIS TIME SCHEDULE TO SHORTER INTERVALS TO MATCH THE ENVIRONMENT.** The most important points of motorcycle inspection, adjustment, and lubrication are explained in the following pages

WARNING

If you are not familiar with motorcycle service, this work should be done by a Yamaha dealer.

Tool kit

The service information included in this manual is intended to provide you, the owner, with the necessary information for completing some of your own preventive maintenance and minor repairs. The tools provided in the owner's tool kit are sufficient for most of these purposes, however, a torque wrench is also necessary to properly tighten nuts and bolts

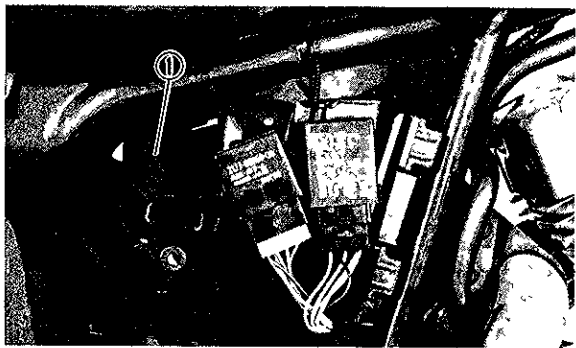

1 Tool kit

EUU06000

NOTE: _____

If you do not have a torque wrench available during a service operation requiring one, take your motorcycle to a Yamaha dealer to check the torque settings and adjust them as necessary.

EUU67100

⚠ WARNING _____

Modifications to this motorcycle not approved by Yamaha may cause loss of performance, and render it unsafe for use. Consult a Yamaha dealer before attempting any changes.

PERIODIC MAINTENANCE/LUBRICATION

Unit km (miles)

Item	Remarks	Break-in 1,000 (600)	EVERY	
			6,000 (4,000) or 6 months	12,000 (8,000) or 12 months
Valve(s)*	Check valve clearance Adjust if necessary	○	○	○
Spark plug(s)	Check condition Clean or replace if necessary	○	○	○
Air filter	Clean Replace if necessary		○	○
Carburetor*	Check idle speed/starter operation Adjust if necessary	○	○	○
Fuel line*	Check fuel hose and vacuum pipe for cracks or damage Replace if necessary		○	○
Fuel filter*	Check condition Replace if necessary			○
Engine oil	Replace (Warm engine before draining)	○	○	○
Engine oil filter*	Replace	○		○
Front brake*	Check operation/fluid leakage/See NOTE Correct if necessary		○	○
Rear brake	Check operation Adjust if necessary		○	○
Clutch	Check operation Adjust if necessary		○	○
Rear arm pivot*	Check rear arm assembly for looseness Correct if necessary Moderately repack every 24,000 (16,000) or 24 months ***			○
Wheels*	Check balance/damage/runout/spoke tightness Repair if necessary		○	○
Wheel bearings*	Check bearings assembly for looseness/damage Replace if damaged		○	○
Steering bearing*	Check bearings assembly for looseness Correct if necessary Moderately repack every 24,000 (16,000) or 24 months **	○		○

Unit km (miles)

Item	Remarks	Break-in 1,000 (600)	EVERY	
			6,000 (4,000) or 6 months	12,000 (8,000) or 12 months
Front forks*	Check operation/oil leakage Repair if necessary		○	○
Rear shock absorber*	Check operation/oil leakage Repair if necessary		○	○
Drive chain	Check chain slack/alignment Adjust if necessary Clean and lube	EVERY 500 (300)		
Fittings/Fasteners*	Check all chassis fittings and fasteners Correct if necessary	○	○	○
Sidestand*	Check operation Replace if necessary	○	○	○
Sidestand switch*	Check operation Clean or replace if necessary	○	○	○
Battery*	Check specific gravity Check breather pipe for proper operation Correct if necessary		○	○

- ** It is recommended that these items be serviced by a Yamaha dealer
- ** Medium weight wheel bearing grease (bearing type)
- *** Lithium soap base grease (Bush type)

NOTE:**Brake fluid replacement:**

1. When disassembling the master cylinder or caliper cylinder replace the brake fluid. Normally check the brake fluid level and add the fluid as required.
2. On the inner parts of the master cylinder and caliper cylinder replace the oil seals every two years
- 3 Replace the brake hose every four years, or if cracked or damaged.

Torque specifications

Use a torque wrench to tighten these items
It is recommended that these items be checked occasionally, especially before a long trip. Always check the tightness of these items whenever they are loosened for any reason

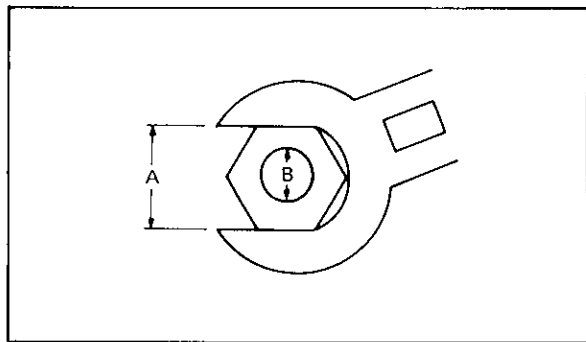

A (Nut)	B (Bolt)	General torque specifications		
		Nm	m·kg	ft·lb
10 mm	6 mm	6	0.6	4.3
12 mm	8 mm	15	1.5	11
14 mm	10 mm	30	3.0	22
17 mm	12 mm	55	5.5	40
19 mm	14 mm	85	8.5	61
22 mm	16 mm	130	13.0	94

Item	Torque		
	Nm	m·kg	ft·lb
Spark plug	12.5	1.25	9.0
Engine drain plug	34	3.4	25
Oil filter bolt	7	0.7	5.1
Front axle pinch bolt	20	2.0	14
Front axle	58	5.8	42
Rear wheel axle	110	11.0	80
Tension bar bolt	20	2.0	14

Engine oil

1. Oil level measurement
 - a. Place the motorcycle on a level place and hold it in an upright position. Warm up the engine for several minutes.

EUU03900

NOTE:

Be sure the motorcycle is positioned straight up when checking the oil level; a slight tilt toward the side can produce false readings.

- b. With the engine stopped, check the oil level through the level window located at the lower part of the right side crankcase cover.

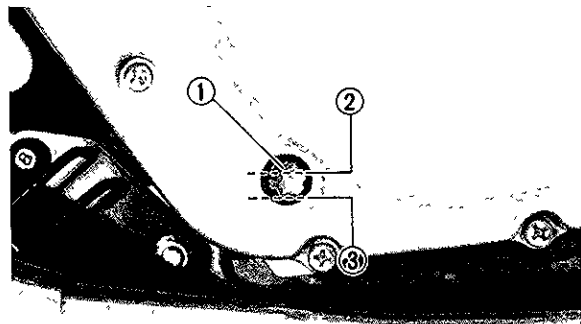

1 Level window 2 Maximum mark 3 Minimum mark

EUU04000

NOTE:

Wait a few minutes until the oil level settles before checking.

- c. The oil level should be between maximum and minimum marks. If the level is low, add sufficient oil to raise it to the proper level.
- 2 Engine oil and oil filter replacement
 - a. Warm-up the engine for a few minutes.

- b. Stop the engine. Place an oil pan under the engine, and remove the oil filler cap.

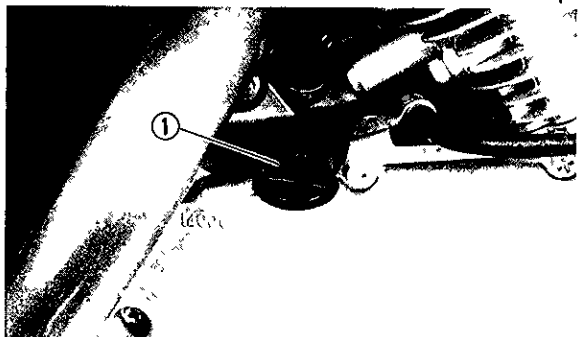

1 Oil filler cap

- c. Remove the drain plug and drain the oil.

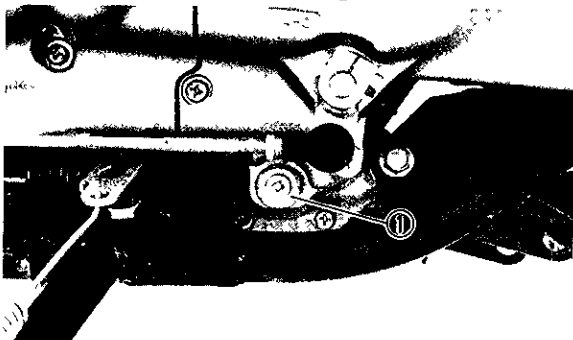

1 Drain plug

- d. Remove the oil filter bolt and filter element.

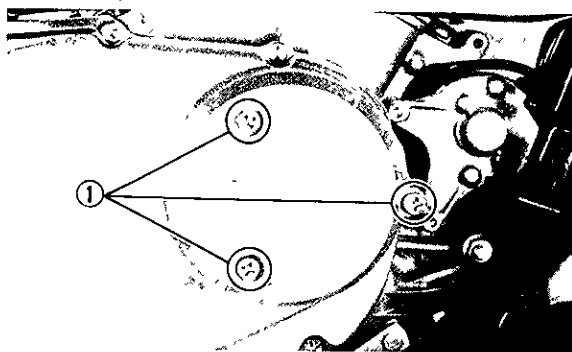

1 Oil filter bolt

- e. Reinstall the drain plug (make sure it is tight).

Drain plug torque:
34 Nm (3.4 m·kg, 25 ft·lb)

- f. Install the new oil filter element, new O-ring, and the filter cover; tighten the oil filter bolt.

Oil filter bolt.

7 Nm (0.7 m·kg, 5.1 ft·lb)

EUU04100

NOTE:

Make sure the O-ring is positioned properly.

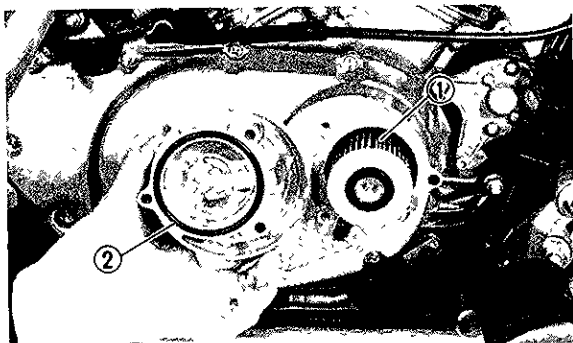

1 Oil filter element

2 O-ring

g. Add oil through the oil filler hole.

Periodic oil change:

1.4 L (1.2 Imp qt, 1.5 US qt)

With oil filter replacement:

1.6 L (1.4 Imp qt, 1.7 US qt)

Recommended oil: See page 6-4.

EUU32300

CAUTION:

Do not add any chemical additives. Engine oil also lubricates the clutch and additives could cause clutch slippage.

EUU32400

CAUTION:

Be sure no foreign material enters the crankcase.

h. After replacement of engine oil and/or oil filter, be sure to check for any oil leakage.

Air filter

1. Remove the air filter case assembly.

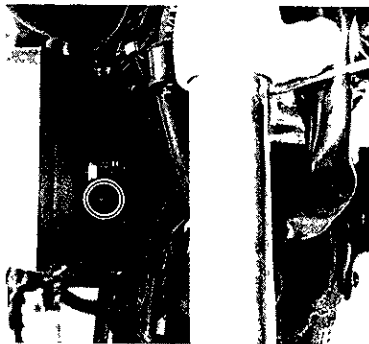
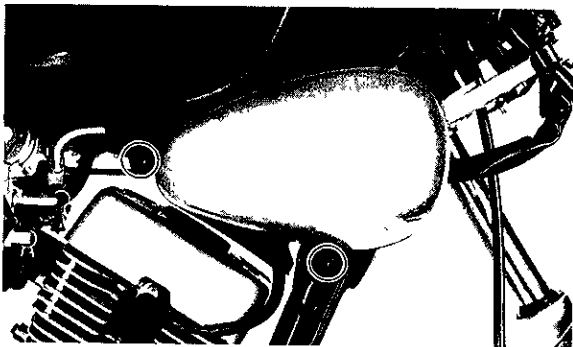

2. Remove the air filter case cover

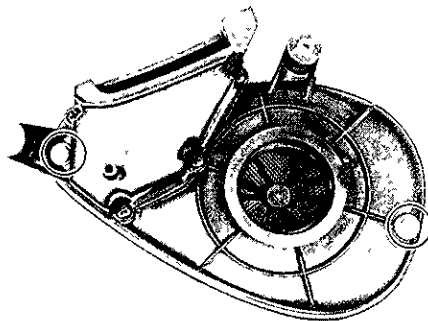

3. Remove the air filter element from its case, and clean it with solvent. After cleaning, remove the remaining solvent by squeezing the element.

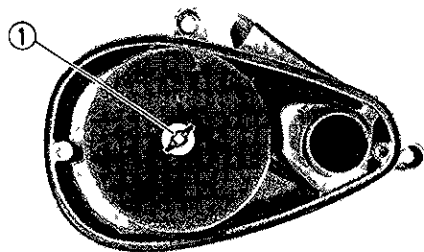

1 Wing nut

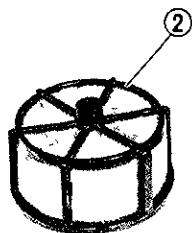

1 Air filter element

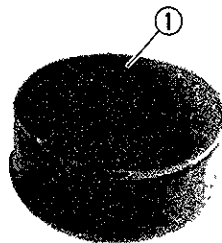

2 Element guide

4. Apply recommended oil to the entire surface of the filter and squeeze out the excess oil. The element should be wet but not dripping.

Recommended oil:
SAE 10W30 motor oil

5. When installing the air filter element in its case, be sure its sealing surface matches the sealing surface of the case so there is no air leak
6. The air filter element should be cleaned at the specified intervals. It should be cleaned more often if the motorcycle is operated in dusty or wet areas.

EUU32600

CAUTION:

The engine should never be run without the air cleaner element; excessive piston and/or cylinder wear may result.

Carburetor adjustment

The carburetor is a vital part of the engine and requires very sophisticated adjustment. Most adjustments should be left to a Yamaha dealer who has the professional knowledge and experience to do so. However, the following point may be serviced by the owner as part of this routine maintenance

EUU13700

NOTE:

A diagnostic tachometer must be used for this procedure.

EUU33000

CAUTION:

The carburetor was set at the Yamaha factory after many tests. If the settings are disturbed, poor engine performance and damage may result.

Idle speed adjustment

- 1 Attach the tachometer Start the engine and warm it up for a few minutes (normally, 1 or 2 minutes) at approximately 1,000 to 2,000 r/min. Occasionally rev the engine to 4,000 to 5,000 r/min. The engine is warm when it quickly responds to the throttle.
- 2 Set the idle to the specified engine speed by adjusting the throttle stop screw; turn the screw in to increase engine speed, and out to decrease engine speed.

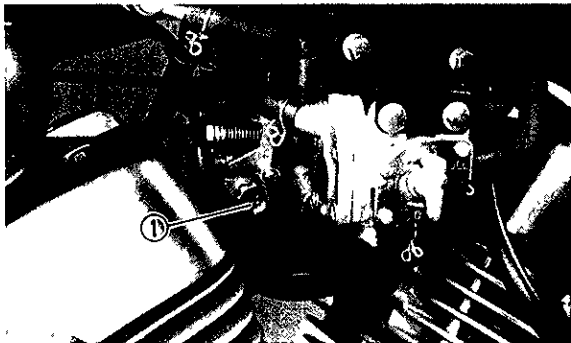

1 Throttle stop screw

Standard idle speed.
1,250 ~ 1,350 r/min

EUU04500

NOTE:

If the specified idle speed cannot be obtained by performing the above adjustment, consult a Yamaha dealer.

EAH90300

Throttle cable adjustment

EUU06400

NOTE:

Before adjusting the throttle cable free play, the engine idling speed should be adjusted.

The throttle cable should have a specified free play in the turning direction at the grip flange. If the play is incorrect, take the following steps for adjustment.

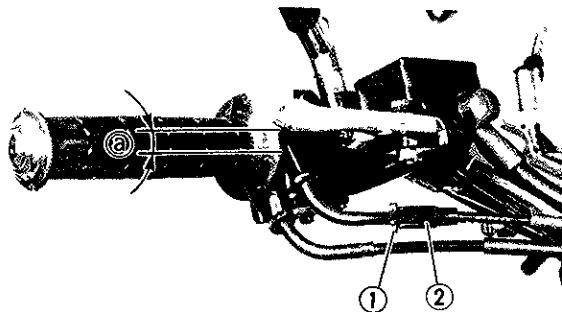

1 Lock nut 2 Adjuster a 3 ~ 5 mm (0.12 ~ 0.20 in)

Free play:

3 ~ 5 mm (0.12 ~ 0.20 in)

1. Loosen the lock nut.
2. Turn the adjuster in or out until the adjustment is suitable.
3. Tighten the lock nut.

Valve clearance adjustment

The valve clearance becomes larger with use, resulting in improper fuel/air supply and engine noise. To prevent this, the valve clearance must be adjusted regularly. This adjustment, however, should be left to a professional Yamaha service technician.

Spark plug inspection

The spark plug is an important engine component and is easy to inspect. The condition of the spark plug can indicate something of the condition of the engine.

Normally, all spark plugs from the same engine should have the same color on the white porcelain insulator around the center electrode. The ideal color at this point is a medium to light tan color for a motorcycle that is being ridden normally. If one spark plug shows a distinctly different color, there could be something wrong with the engine.

Do not attempt to diagnose such problems yourself. Instead, take the motorcycle to a Yamaha dealer. You should periodically remove and inspect the spark plugs because heat and deposits will cause any spark plug to slowly break down and erode. If electrode erosion becomes excessive, or if carbon and other deposits are excessive, you should replace the spark plug with a proper type of plug.

Standard spark plug.
CR6HS (NGK) or U20FSR-U
(NIPPONDENSO)

Before installing any spark plug, measure the electrode gap with a wire thickness gauge, adjust the gap to specification as necessary.

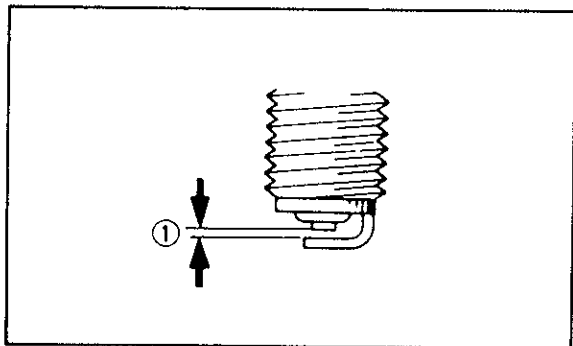

1 Spark plug gap

Spark plug gap:

0.6 ~ 0.7 mm (0.024 ~ 0.028 in)

When installing the plug, always clean the gasket surface and use a new gasket. Wipe off any grime from the threads, and torque the spark plug properly.

Spark plug torque:

12.5 Nm (1.25 m·kg, 9.0 ft·lb)

EUU03800

NOTE:

If a torque wrench is not available when you are installing a spark plug, a good estimate of the correct torque is 1/4 to 1/2 turns past finger tight. Have the spark plug torqued to the correct value as soon as possible with a torque wrench.

EAH80100

Front brake adjustment

The free play at the end of the front brake lever should be 2 ~ 5 mm (0.08 ~ 0.2 in).

1. Loosen the lock nut.
2. Turn the adjuster so that the brake lever movement at the lever end is 2 ~ 5 mm (0.08 ~ 0.2 in) before the adjuster contacts the master cylinder piston.
3. After adjusting, tighten the lock nut.

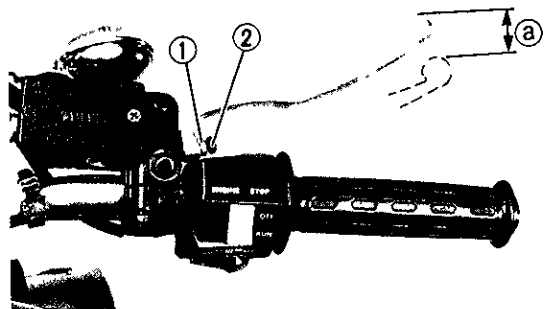

1 Lock nut 2 Adjuster a 2~5 mm (0.08~0.2 in)

EUU63600

⚠ WARNING

Check the brake lever free play. Be sure the brake is working properly.

EUU64100

⚠ WARNING

A soft or spongy feeling in the brake lever can indicate the presence of air in the brake system. This air must be removed by bleeding the brake system

before the motorcycle is operated. Air in the system will cause greatly diminished braking capability and can result in loss of control and an accident. Have a Yamaha dealer inspect and bleed the system if necessary.

EAH87100

Rear brake adjustment

EUU64300

⚠ WARNING

For brake pedal adjustment, be sure to proceed as follows (it is advisable to have a Yamaha dealer make this adjustment).

1. Pedal height
 - a. Loosen the adjuster lock nut (for pedal height).
 - b. By turning the adjuster clockwise or counterclockwise, adjust the brake pedal position as shown below
 - c. Secure the adjuster lock nut

⚠ WARNING

After adjusting the pedal height adjust brake pedal free play.

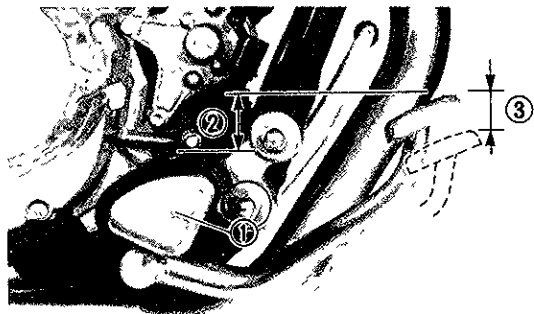

- 1 Footrest 2 Pedal height: 45~55 mm (1.8~2.2 in)
 3 Free play: 20~30 mm (0.8~1.2 in)

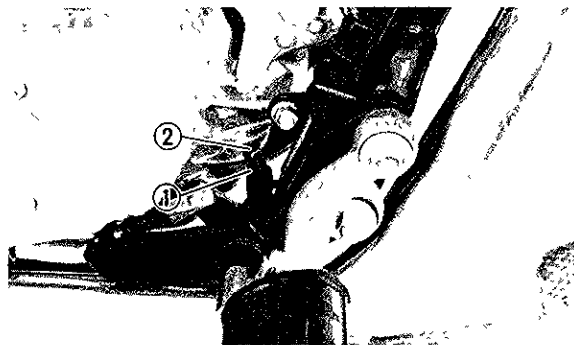

- 1 Lock nut 2 Adjuster (for pedal height)

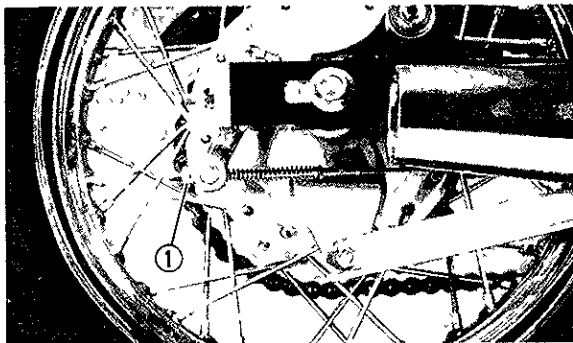

- 1 Adjuster

⚠ WARNING

1. The rear brake pedal adjustment must be checked whenever the chain is adjusted or the rear wheel is removed and then reinstalled.
2. Check the operation of the brake light after adjusting the rear brake.

EAH83300

Brake light switch adjustment

The brake light switch is operated by movement of the brake pedal. To adjust, hold the main body of the switch with your hand so it does not rotate and turn the adjusting nut. Proper adjustment is achieved when the brake light comes on just before the brake begins to take effect.

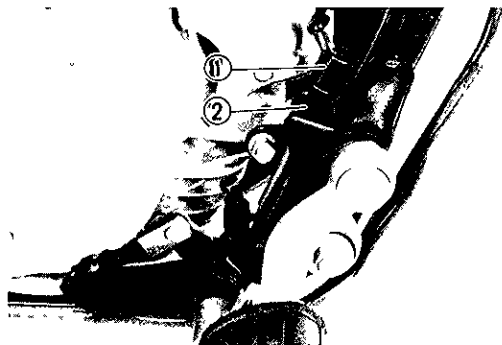

1 Main body

2 Adjusting nut

EAH81400

Checking the front brake pads and rear brake shoes

A wear indicator is attached to each brake to facilitate brake pad and shoe check. This indicator permits a visual check without disassembling the brake.

EAH82100

FRONT

To check, depress the brake and inspect the wear indicator. If the wear indicator is ALMOST in contact with the disc plate, ask a Yamaha dealer to replace the pads

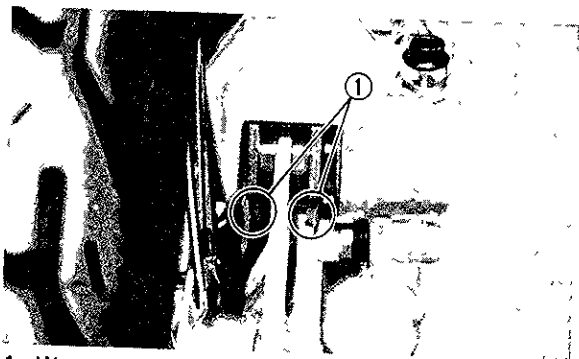

1 Wear indicator

EAH82600

REAR

To check, look at the wear indicator while depressing the brake pedal. If the indicator reaches the wear limit line, ask a Yamaha dealer to replace the shoes.

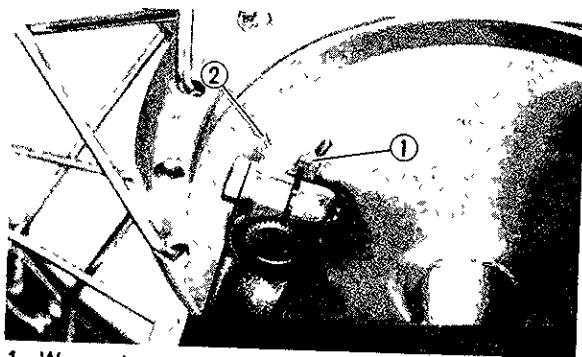

1 Wear indicator

2 Wear limit

EAH88200

Inspecting the brake fluid level

Insufficient brake fluid may let air enter the brake system, possibly causing the brakes to become ineffective.

Before riding, check the brake fluid level and replenish when necessary. Observe these precautions.

1. When checking the fluid level, make sure the master cylinder top is horizontal by turning the handlebars.

2. Use only the designated quality brake fluid, otherwise, the rubber seals may deteriorate, causing leakage and poor brake performance.

Recommended brake fluids: DOT#4

EUU13100

NOTE:

If DOT #4 is not available, #3 can be used

3. Refill with the same type of brake fluid, mixing fluids may result in a harmful chemical reaction and lead to poor performance.
4. Be careful that water does not enter the master cylinder when refilling. Water will significantly lower the boiling point of the fluid and may result in vapor lock.
5. Brake fluid may erode painted surfaces or plastic parts. Always clean up spilled fluid immediately.

6. Have a Yamaha dealer check the cause if the brake fluid level goes down.

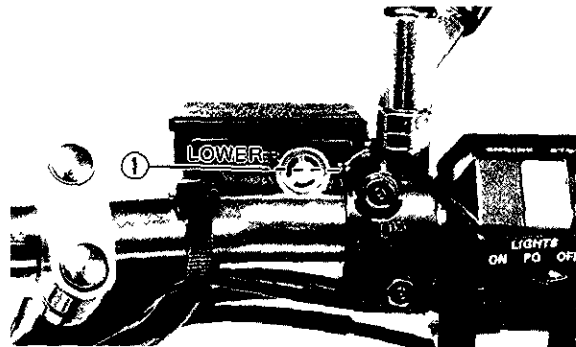

1 Lower level

EAH83500

Brake fluid replacement

- 1 Complete fluid replacement should be done only by trained Yamaha service personnel.
- 2 Have a Yamaha dealer replace the following components when indicated in the schedule or when they are damaged or leaking

- a. Replace all rubber seals every two years.
- b. Replace all hoses every four years.

EAI00900

Clutch adjustment

This model has two clutch cable length adjusters. The cable length adjusters are used to take up slack from cable stretch and to provide sufficient free play for proper clutch operation.

EAI00500

Free play adjustment

The clutch should be adjusted to suit the rider's preference; but free play at the lever pivot should be 3 ~ 5 mm (0.12 ~ 0.20 in). Loosen either the handlebar lever adjuster lock nut or the cable length adjuster lock nut. Turn the cable length adjuster either in or out until proper lever free play is achieved.

Clutch lever free play:

3 ~ 5 mm (0.12 ~ 0.20 in)

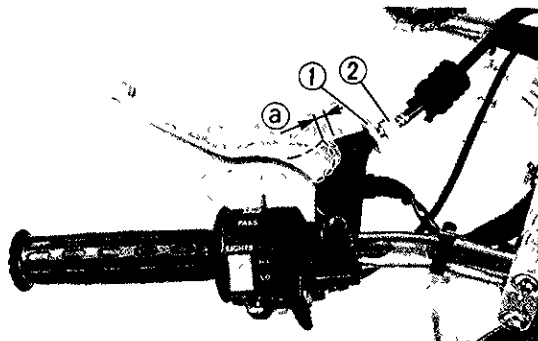

1 Lock nut 2 Adjuster a 3~5 mm (0.12~0.20 in)

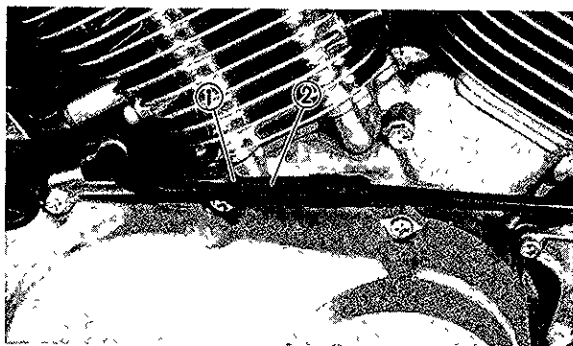

1 Lock nut 2 Adjuster

Drive chain slack check

EUU04800

NOTE:

Before checking and/or adjusting the chain slack, rotate the rear wheel through several revolutions. Check the chain slack several times to find the point where the chain is the tightest. Check and/or adjust the chain slack where the rear wheel is in this "tight chain" position.

To check the chain slack the motorcycle must stand vertically with both wheels on the ground and without a rider. Check the slack at the position shown in the illustration. The normal vertical deflection is approximately 30 ~ 40 mm (1.2 ~ 1.6 in). If the deflection exceeds 40 mm (1.6 in) adjust the chain slack.

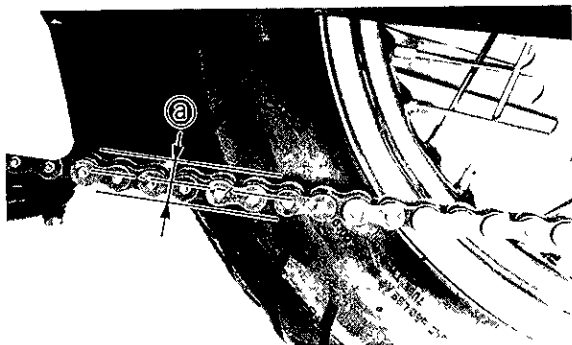

a 30~40 mm (1.2~1.6 in)

Drive chain slack adjustment

1. Loosen the rear brake adjuster.

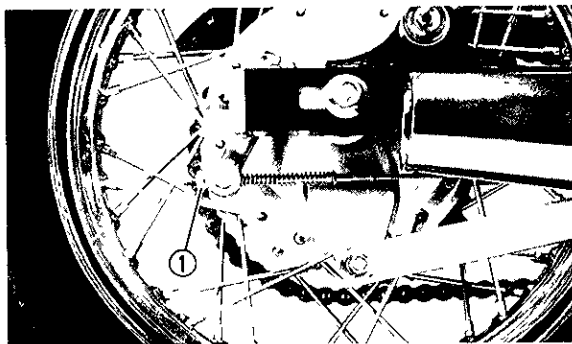

1 Adjuster

- 2 Remove the cotter pin from the rear wheel axle nut.

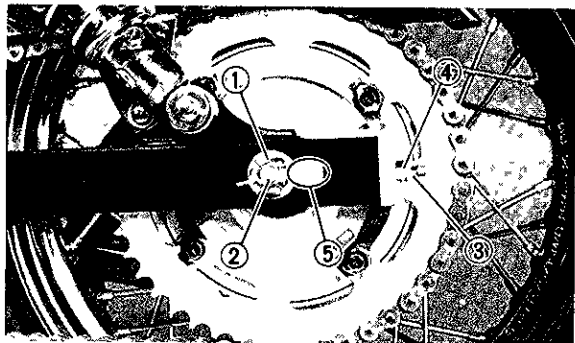

- | | | |
|------------|-----------------------|------------|
| 1 Axle nut | 2 Cotter pin | 3 Lock nut |
| 4 Adjuster | 5 Marks for alignment | |

- 3 Loosen the rear wheel axle nut.
4. Loosen the lock nuts on each side. To tighten the chain, turn the chain adjuster clockwise. To loosen the chain, turn the adjuster counterclockwise and push the wheel forward. Turn each adjuster exactly the same amount to maintain correct axle alignment. (There are marks

on each chain adjuster; use them to check for proper alignment)

EUU33300

CAUTION

Too small chain slack will overload the engine and other vital parts; keep the slack within the specified limits.

5. After adjusting, be sure to tighten the lock nuts and the axle nut.

Axle nut torque:
110 Nm (11.0 m·kg, 80 ft·lb)

6. Insert a new cotter pin into the rear wheel axle nut and bend the end of the cotter pin as shown in the illustration. (If the nut notch and the cotter pin hole do not match, tighten the nut slightly to align them.)

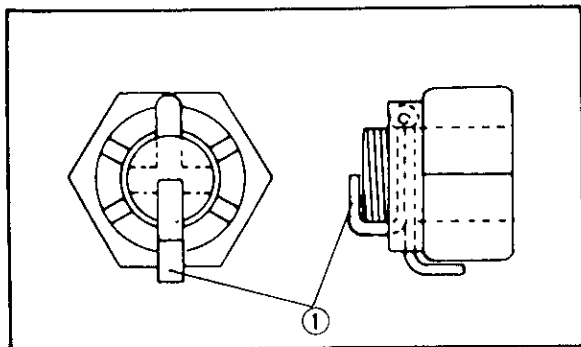

1 Cotter pin

EUU64700

⚠ WARNING

Always use a new cotter pin on the axle nut.

7. Adjust the free play in the brake pedal.

EUU64500

⚠ WARNING

Check the operation of the brake light after adjusting the rear brake.

EAI40700

Drive chain lubrication

The chain consists of many parts which work against each other. If the chain is not maintained properly, it will wear out rapidly, therefore, form the habit of periodically servicing the chain. This service is especially necessary when riding in dusty conditions. This motorcycle has a drive chain with small rubber O-rings between the chain plates. Steam cleaning, high-pressure washes, and certain solvents can damage these O-rings. Use only kerosene to clean the drive chain. Wipe it dry, and thoroughly lubricate it with SAE 30 ~ 50W motor oil. Do not use any other lubricants on the drive chain. They may contain solvents that could damage the O-rings.

Cable inspection and lubrication

⚠ WARNING

Damage to the outer housing of the various cables may cause corrosion and interfere with the movement of the cable. An unsafe condition may result so replace such cables as soon as possible.

Lubricate the inner cable and the cable end. If they do not operate smoothly, ask a Yamaha dealer to replace them

Recommended lubricant.
SAE 10W30 motor oil

Throttle cable and grip lubrication

The throttle twist grip assembly should be greased at the time that the cable is lubricated, since the grip must be removed to get at the

end of the throttle cable. Two screws clamp throttle housing to the handlebar. Once these two are removed, the end of the cable can be held high to pour in several drops of lubricant. With the throttle grip disassembled, coat the metal surface of the grip assembly with a suitable all-purpose grease.

Brake and shift pedals

Lubricate the pivoting parts.

Recommended lubricant:
SAE 10W30 motor oil

Brake and clutch levers

Lubricate the pivoting parts.

Recommended lubricant:
SAE 10W30 motor oil

EAI31100

Sidestand

Lubricate the pivoting parts. Check to see that the sidestand moves up and down smoothly.

Recommended lubricant.
SAE 10W30 motor oil

EUU70400

WARNING

If the sidestand movement is not smooth, consult a Yamaha dealer.

EAI20500

Front fork inspection

EUU65700

WARNING

Securely support the motorcycle so there is no danger of it falling over.

1. Visual check

Check for scratches/damage on the inner tube and excessive oil leakage with the front fork.

2. Operation check

Place the motorcycle on a level place

- Hold the motorcycle on an upright position with the rider's hands on the handlebar, and apply the front brake
- Pump the front forks up and down several times

EUU42500

CAUTION

If any damage or unsmooth movement is found with the front fork, consult a Yamaha dealer.

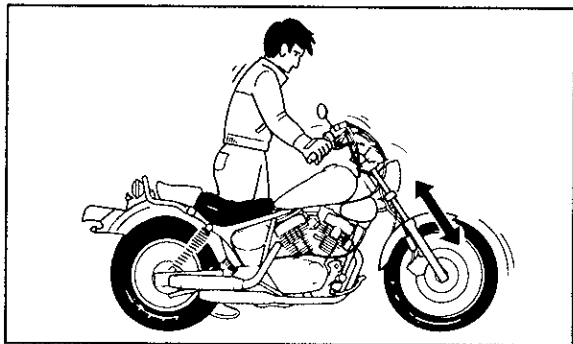

EAI50900

Rear shock absorber adjustment

Spring preload

If the spring seat is raised, the spring becomes stiffer, and if lowered, it becomes softer

Standard position. 2

1. — Softest

5 — Stiffest

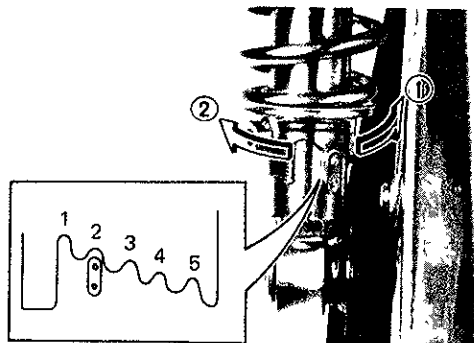

1 Softer

2 Stiffer

EUU65200

⚠ WARNING

Always adjust each shock absorber to the same setting. Uneven adjustment can cause poor handling and loss of stability.

EAI60300

Steering inspection

Periodically inspect the condition of the steering. Worn out or loose steering bearings may be dangerous. Place a block under the engine to raise the front wheel off the ground. Hold the lower end of the front forks and try to move them forward and backward. If any free play can be felt, ask a Yamaha dealer to inspect and adjust the steering. Inspection is easier if the front wheel is removed.

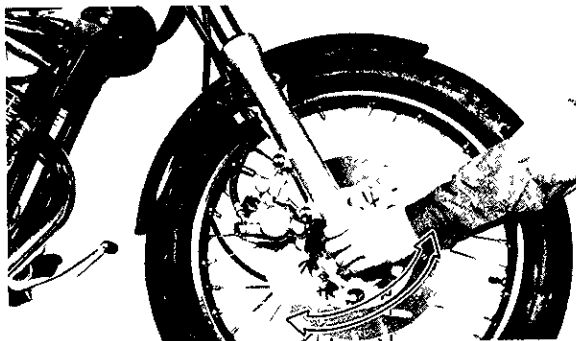

EUU65700

WARNING

Securely support the motorcycle so there is no danger of it falling over.

EAI60200

Wheel bearings

If the wheel bearings in the front or rear wheel allow play in the wheel hub or if the wheel does not turn smoothly, have a Yamaha dealer inspect the wheel bearings. The wheel bearings should be inspected according to the Maintenance Schedule.

EAI70000

Battery

Check the level of the battery electrolyte and see that the terminals are tight. Add distilled water if the electrolyte level is low.

CAUTION:

When inspecting the battery, be sure the breather pipe is routed correctly. If the breather pipe touches the frame or exits in such a way as to cause battery electrolyte or gas to exit onto the frame, structural and cosmetic damage to the motorcycle can occur.

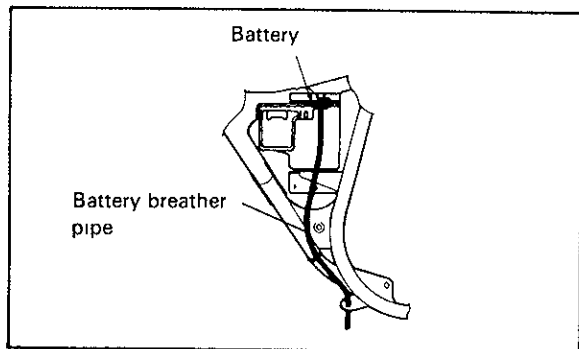
**! WARNING**

Battery electrolyte is poisonous and dangerous, causing severe burns, etc. It contains sulfuric acid. Avoid contact with skin, eyes or clothing.

Antidote: EXTERNAL-Flush with water. INTERNAL-Drink large quantities of water or milk. Follow with milk of magnesia, beaten egg, or vegetable oil. Call a physician immediately.

Eyes: Flush with water for 15 minutes and get prompt medical attention. Batteries produce explosive gases. Keep sparks, flame, cigarettes etc., away. Ventilate when charging or using in an enclosed space. Always shield your eyes when working near batteries. **KEEP OUT OF REACH OF CHILDREN.**

Replenishing the battery fluid

A poorly maintained battery will deteriorate quickly. The battery fluid should be checked at least once a month

- 1 The level should be between the upper and lower level marks. Use only distilled water if refilling is necessary.

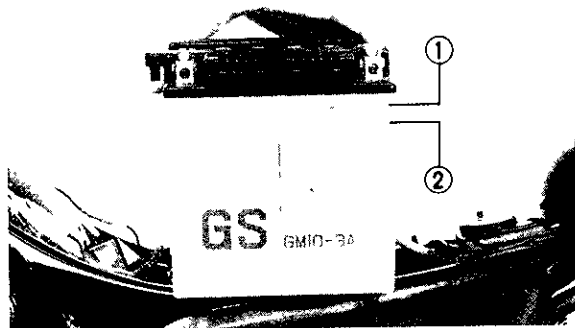

1 Upper level

2 Lower level

CAUTION

Normal tap water contains minerals which are harmful to a battery; therefore, refill only with distilled water.

WARNING

Battery fluid on the chain can cause premature failure and possibly an accident.

- 2 When the motorcycle will not be used for a month or longer, remove the battery and store it in a cool, dark place. Completely recharge the battery before reusing.
3. If the battery will be stored for a longer period than the above, check the specific gravity of the fluid at least once a month and recharge the battery when it is too low.

- 4 Always make sure the connections are correct when putting the battery back in the motorcycle. Make sure the breather pipe is properly connected and is not damaged or obstructed.

EAI91800

Fuse replacement

- 1 The fuse is located under the seat.

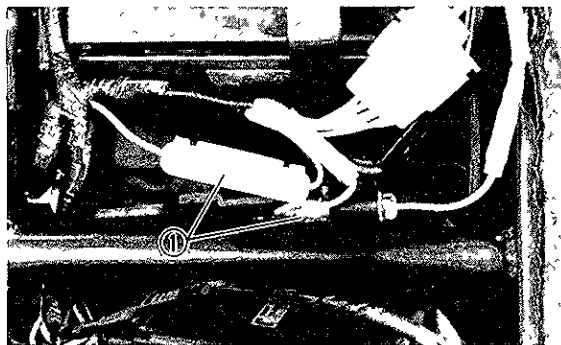

1 Fuse

2. If a fuse is blown, turn off the ignition switch and the switch in the circuit in question. Install a new fuse of proper amperage.

Turn on the switches, and see if the electrical device operates. If the fuse immediately blows again, consult a Yamaha dealer.

EUU34400

CAUTION:

Do not use fuses of higher amperage rating than those recommended. Substitution of a fuse of improper rating can cause extensive electrical system damage and possibly a fire.

EAI80001

Replacing the headlight bulb

This motorcycle is equipped with a quartz bulb headlight. If the headlight bulb burns out, replace the bulb as follows:

- 1 Remove the 2 screws holding the light unit assembly.

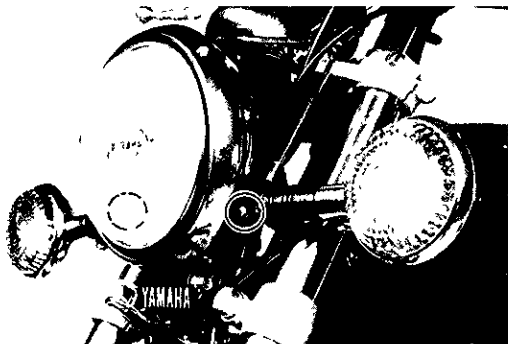

- 2 Disconnect the lead wires, and remove the light unit assembly.



3. Turn the bulb holder counterclockwise and remove the defective bulb.

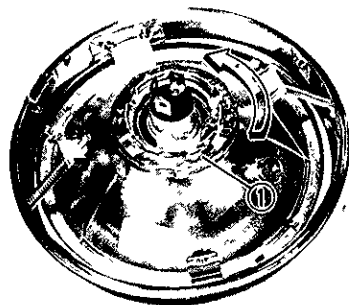

1 Bulb holder

EUU66000

⚠ WARNING

Keep flammable products and your hands away from the bulb while it is on, as it is hot. Do not touch the bulb until it cools down.

4. Slip a new bulb into position and secure it in place with the bulb holder

CAUTION:

Avoid touching the glass part of the bulb. Keep it free from oil; otherwise, the transparency of the glass, life of the bulb, and illuminous flux will be adversely affected. If oil gets on the bulb, thoroughly clean it with a cloth moistened with alcohol or lacquer thinner.

5. Reinstall the light unit assembly.
If the headlight beam adjustment is necessary, ask a Yamaha dealer to make adjustment.

Front wheel removal

- 1 Elevate the front wheel by placing a suitable stand under the engine
2. Remove the speedometer cable at the speedometer gear housing.

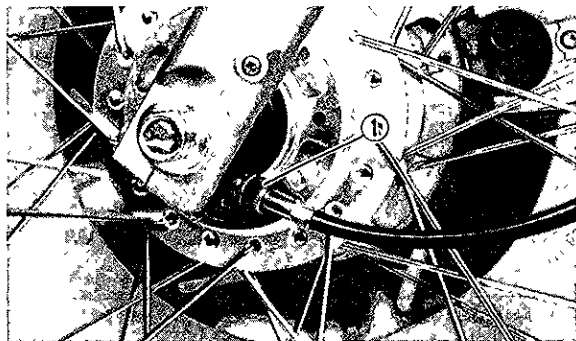

1 Speedometer cable

3. Loosen the pinch bolt securing the wheel axle.

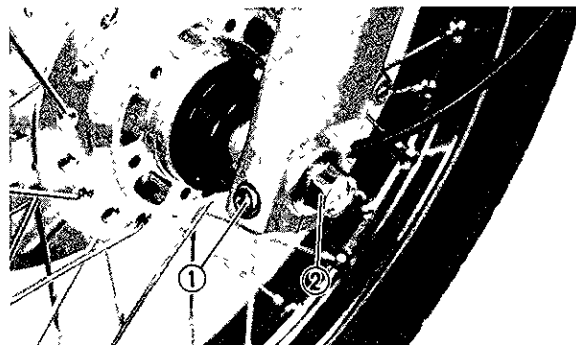

1 Pinch bolt

2 Front axle

4. Remove the axle and the front wheel.
Make sure the motorcycle is properly supported

EUU05400

NOTE: _____

Do not depress the brake lever when the disc is off the caliper as the brake pads will be forced shut.

EAJ21700

Front wheel installation

When installing the front wheel, reverse the removal procedure.

Pay attention to the following points.

1. Make sure the wheel hub and the speedometer clutch assembly are installed with the projections meshed into the slots

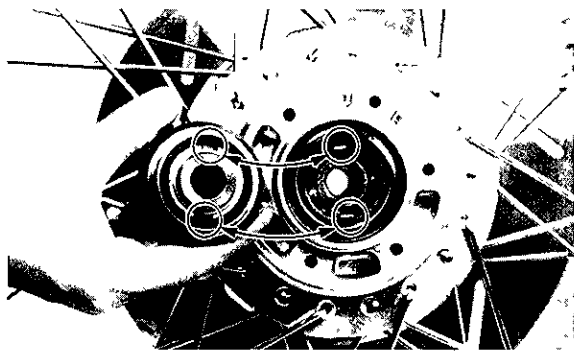

2. Make sure the projecting portion (torque stopper) of the speedometer housing is positioned correctly

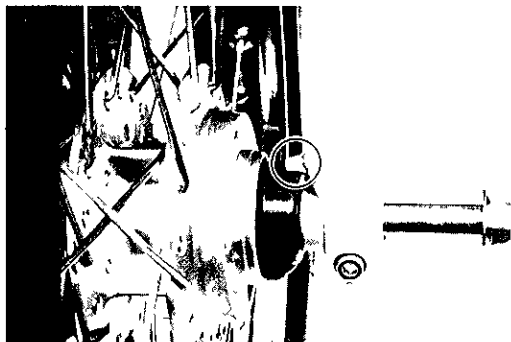

3. Make sure the axle is properly torqued.

Tightening torque.

58 Nm (5.8 m·kg, 42 ft·lb)

4. Before tightening the pinch bolt, compress the front forks several times to check for proper fork operation.
5. Tighten the axle pinch bolt.

Axle pinch bolt torque:

20 Nm (2.0 m·kg, 14 ft·lb)

EAJ31200

Rear wheel removal

EUU66200

⚠ WARNING

It is advisable to have a Yamaha dealer service the rear wheel.

- 1 Elevate the rear wheel by placing a suitable stand under the engine.

2. Remove the tension bar and the brake rod from the brake shoe plate. The tension bar can be removed by removing the cotter pin and nut from the tension bar bolt. The brake rod can be removed by removing the adjuster.

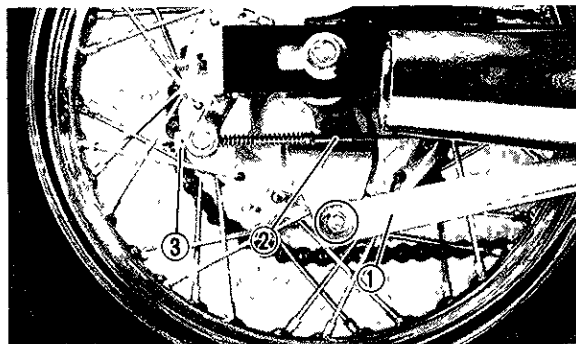

1 Tension bar 2 Brake rod 3 Adjuster

3. Loosen the lock nuts of the right and left chain adjusters and loosen the adjusters.
4. Remove the axle nut cotter pin and the axle nut.

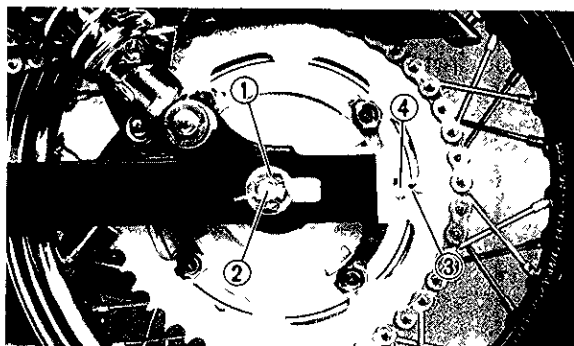

- 1 Axle nut 2 Cotter pin 3 Lock nut
4 Adjuster

5. The rear wheel assembly, the collar, the chain puller(s), etc., can be removed from the motorcycle by pulling the wheel axle.

EUU05600

NOTE:

You do not have to disassemble the chain in order to remove or install the rear wheel

EAJ34000

Rear wheel installation

When installing the rear wheel, reverse the removal procedure. Pay attention to the following points:

1. Adjust the drive chain.
2. Make sure the axle nut and tension bar bolt are properly torqued, and a new cotter pin is installed

EUU64700

⚠ WARNING

Always use a new cotter pin on the axle nut.

EUU71600

⚠ WARNING

Always use a new cotter pin on the tension bar bolt.

Tightening torque:

Axle nut.

110 Nm (11.0 m·kg, 80 ft·lb)

Tension bar bolt:

20 Nm (2.0 m·kg, 14 ft·lb)

3. Adjust the rear brake. (See page 8-15)

EUU64500

 WARNING

Check the operation of the brake light after adjusting the rear brake.

EAJ50000

Troubleshooting

Although Yamaha motorcycles receive a rigid inspection before shipment from the factory, trouble may occur during operation. Any problem in the fuel, compression, or ignition systems can cause poor starting and loss of power. The troubleshooting chart describes a quick, easy procedure for checking these systems. If your motorcycle requires any repair, bring it to a Yamaha dealer. The skilled technicians at a Yamaha dealer ship have the tools, experience, and know-how to properly service your motorcycle. Use only genuine Yamaha parts on your motorcycle. Imitations parts may look like Yamaha parts, but they are often inferior. Consequently, they have a shorter service life and can lead to expensive repair bills.

7. Clean the seat with a vinyl upholstery cleaner to keep the cover pliable and glossy.
8. Automotive-type wax may be applied to all painted and chrome-plated surfaces. Avoid combination cleaner-

the tank, shake the tank to coat the inner surfaces thoroughly and drain off the excess oil. Reinstall the tank.

3. Remove the spark plug, pour about one tablespoon of SAE 10W30 or 20W40 motor oil in the spark plug hole and

— MEMO —

YAMAHA MOTOR CO.,LTD.

PRINTED IN JAPAN
91 5 - 03 × 1 CR
(英)

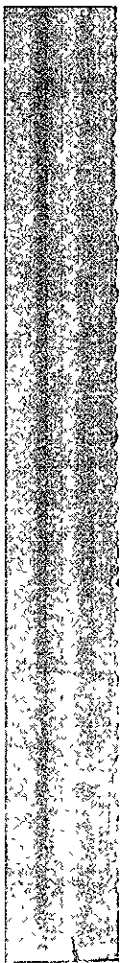

WIRING DIAGRAM

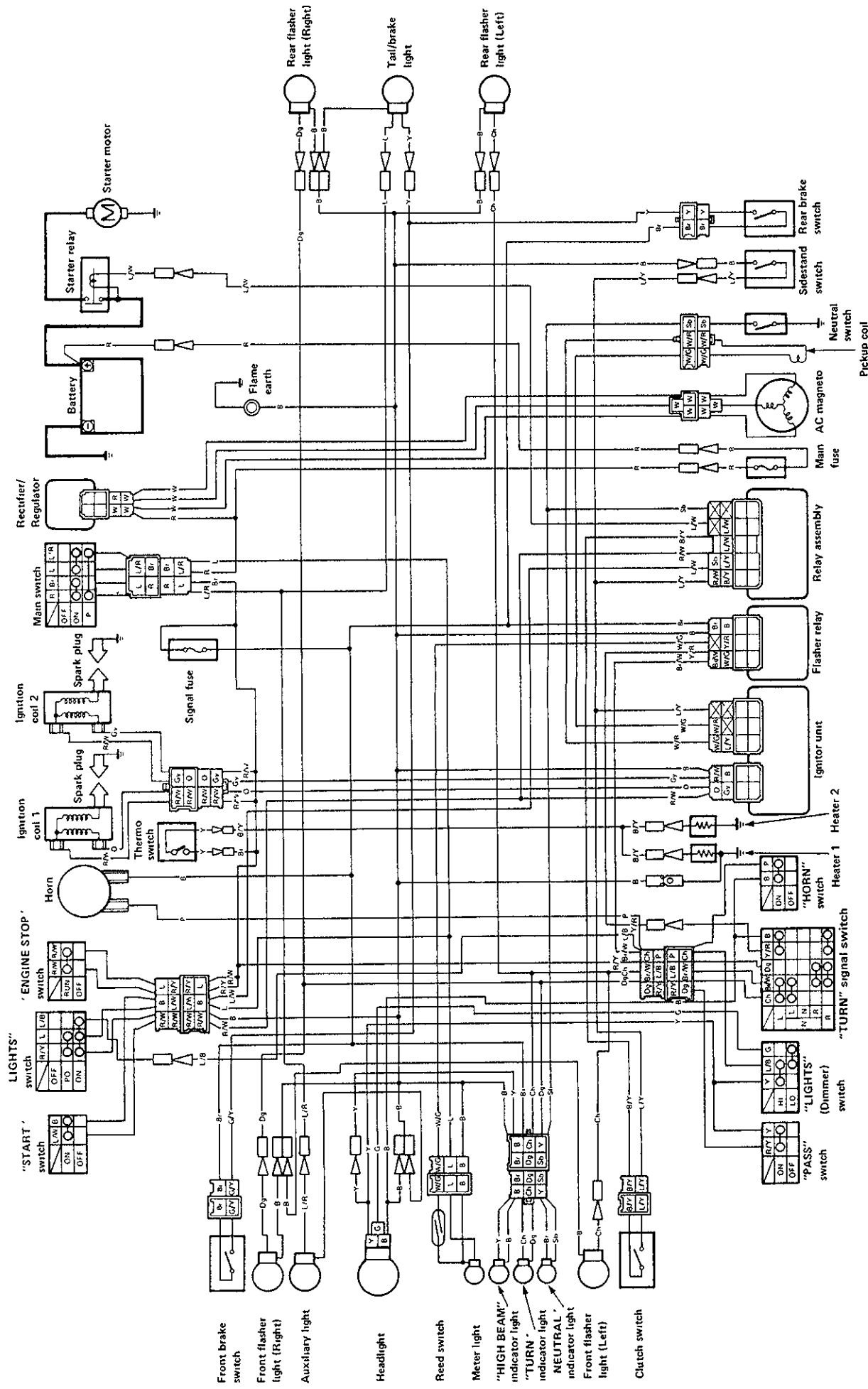

COLOR CODE

B	Black	Gy	Gray	Y/R	Yellow/Red	R/W	Red/White
Y	Yellow	Ch	Chocolate	L/B	Blue/Black	Br/W	Brown/White
L	Blue	Br	Brown	L/Y	Blue/Yellow	W/G	White/Green
G	Green	Sb	Sky blue	L/R	Blue/Red	W/R	White/Red
R	Red	Dg	Dark green	L/W	Blue/White		
O	Orange	W	White	G/Y	Green/Yellow		
P	Pink	B/Y	Black/Yellow	R/Y	Red/Yellow		