



⚠ Read this manual carefully before operating this vehicle.

OWNER'S MANUAL



XVS650Z
XVS650AZ

1BF-28199-20

 **Read this manual carefully before operating this vehicle. This manual should stay with this vehicle if it is sold.**

Welcome to the Yamaha world of motorcycling!

As the owner of the XVS650Z/XVS650AZ, you are benefiting from Yamaha's vast experience and newest technology regarding the design and manufacture of high-quality products, which have earned Yamaha a reputation for dependability. Please take the time to read this manual thoroughly, so as to enjoy all advantages of your XVS650Z/XVS650AZ. The Owner's Manual does not only instruct you in how to operate, inspect and maintain your motorcycle, but also in how to safeguard yourself and others from trouble and injury.

In addition, the many tips given in this manual will help keep your motorcycle in the best possible condition. If you have any further questions, do not hesitate to contact your Yamaha dealer.

The Yamaha team wishes you many safe and pleasant rides. So, remember to put safety first!

Yamaha continually seeks advancements in product design and quality. Therefore, while this manual contains the most current product information available at the time of printing, there may be minor discrepancies between your motorcycle and this manual. If there is any question concerning this manual, please consult a Yamaha dealer.



Please read this manual carefully and completely before operating this motorcycle.

IMPORTANT MANUAL INFORMATION

EAU10132

Particularly important information is distinguished in this manual by the following notations:

	This is the safety alert symbol. It is used to alert you to potential personal injury hazards. Obey all safety messages that follow this symbol to avoid possible injury or death.
	A WARNING indicates a hazardous situation which, if not avoided, could result in death or serious injury.
NOTICE	A NOTICE indicates special precautions that must be taken to avoid damage to the vehicle or other property.
TIP	A TIP provides key information to make procedures easier or clearer.

IMPORTANT MANUAL INFORMATION

EAU10200

**XVS650Z/XVS650AZ
OWNER'S MANUAL
©2009 by Yamaha Motor Co., Ltd.
1st edition, April 2009
All rights reserved.
Any reprinting or unauthorized use
without the written permission of
Yamaha Motor Co., Ltd.
is expressly prohibited.
Printed in Japan.**

TABLE OF CONTENTS

LOCATION OF IMPORTANT

LABELS 1-1

SAFETY INFORMATION 2-1

DESCRIPTION 3-1

Left view 3-1

Right view 3-2

Controls and instruments 3-3

INSTRUMENT AND CONTROL

FUNCTIONS 4-1

Immobilizer system (XVS650AZ) 4-1

Main switch/steering lock
(XVS650Z) 4-2

Main switch/steering lock
(XVS650AZ) 4-2

Indicator and warning lights 4-4

Speedometer unit 4-5

Self-diagnosis device 4-6

Handlebar switches 4-6

Clutch lever 4-7

Shift pedal (XVS650Z) 4-8

Shift pedal (XVS650AZ) 4-8

Brake lever 4-8

Brake pedal 4-9

Fuel tank cap 4-9

Fuel 4-10

Fuel cock 4-11

Starter (choke) knob 4-12

Seats (XVS650Z) 4-12

Seats (XVS650AZ) 4-13

Helmet holder 4-15

Storage compartment 4-15

Adjusting the shock absorber
assembly 4-16

Luggage strap holders 4-17

Sidestand 4-17

Ignition circuit cut-off system 4-18

FOR YOUR SAFETY –

PRE-OPERATION CHECKS 5-1

OPERATION AND IMPORTANT

RIDING POINTS 6-1

Starting and warming up a cold
engine 6-1

Starting a warm engine 6-2

Shifting 6-2

Tips for reducing fuel
consumption 6-3

Engine break-in 6-3

Parking 6-4

PERIODIC MAINTENANCE AND

ADJUSTMENT 7-1

Owner's tool kit 7-1

Periodic maintenance chart for the
emission control system 7-2

General maintenance and
lubrication chart 7-3

Removing and installing panels 7-7

Checking the spark plugs 7-8

Engine oil and oil filter element 7-9

Final gear oil 7-12

Cleaning the air filter element 7-13

Adjusting the carburetors 7-14

Adjusting the engine idling
speed 7-15

Checking the throttle cable free
play 7-15

Valve clearance 7-16

Tires 7-16

Spoke wheels 7-18

Adjusting the clutch lever free
play 7-18

Adjusting the brake lever free
play 7-19

Adjusting the brake pedal position
and free play 7-20

Adjusting the rear brake light
switch 7-21

Checking the front brake pads
and rear brake shoes 7-22

Checking the brake fluid level 7-22

Changing the brake fluid 7-23

Checking and lubricating the
cables 7-23

Checking and lubricating the
throttle grip and cable 7-24

Checking and lubricating the
brake and shift pedals 7-24

TABLE OF CONTENTS

Checking and lubricating the brake and clutch levers	7-25	Motorcycle noise regulation (for Australia)	10-2
Checking and lubricating the sidestand	7-25		
Lubricating the swingarm pivots ...	7-26		
Checking the front fork	7-26		
Checking the steering	7-27		
Checking the wheel bearings	7-27		
Battery	7-27		
Replacing the fuses	7-29		
Replacing the headlight bulb	7-30		
Replacing a turn signal light bulb or the tail/brake light bulb	7-31		
Replacing the auxiliary light bulb (XVS650AZ)	7-32		
Supporting the motorcycle	7-32		
Front wheel	7-33		
Rear wheel	7-34		
Troubleshooting	7-36		
Troubleshooting chart	7-37		
MOTORCYCLE CARE AND STORAGE	8-1		
Matte color caution	8-1		
Care	8-1		
Storage	8-3		
SPECIFICATIONS	9-1		
CONSUMER INFORMATION	10-1		
Identification numbers	10-1		

LOCATION OF IMPORTANT LABELS



EAU10383

1

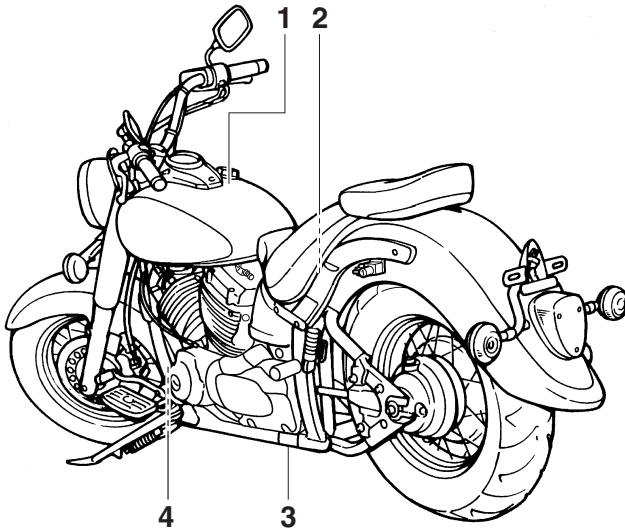
Read and understand all of the labels on your vehicle. They contain important information for safe and proper operation of your vehicle. Never remove any labels from your vehicle. If a label becomes difficult to read or comes off, a replacement label is available from your Yamaha dealer.



1

	<ul style="list-style-type: none">• Before you operate this vehicle, read the owner's manual.• Prima di usare il veicolo, leggete il manuale di istruzioni.• Lire le manuel du propriétaire avant d'utiliser ce véhicule.• Lesen Sie die Bedienungsanleitung bevor Sie dieses Fahrzeug fahren.• Antes de conducir este vehículo, lea el Manual del Propietario.
	

5RU-21568-01

2



LOCATION OF IMPORTANT LABELS

1

3 XVS650Z

TIRE INFORMATION

Cold tire normal pressure should be set as follows.

- Up to 90 kg (198 lbs) load

FRONT : 200 kPa, (2.00 kgf/cm²), 29 psi
REAR : 225 kPa, (2.25 kgf/cm²), 33 psi

- 90kg (198 lbs) ~ maximum load

FRONT : 200 kPa, (2.00 kgf/cm²), 29 psi
REAR : 250 kPa, (2.50 kgf/cm²), 36 psi

3B6-21668-00

3 XVS650AZ

TIRE INFORMATION

Cold tire normal pressure should be set as follows.

- Up to 90 kg (198 lbs) load

FRONT : 225 kPa, (2.25 kgf/cm²), 33 psi
REAR : 225 kPa, (2.25 kgf/cm²), 33 psi

- 90kg (198 lbs) ~ maximum load

FRONT : 225 kPa, (2.25 kgf/cm²), 33 psi
REAR : 250 kPa, (2.50 kgf/cm²), 36 psi

1B1F-21668-00

4

STATIONARY NOISE TEST INFORMATION
TESTED 86 dB(A) AT 3250 r/min
SILENCING SYSTEM : YAMAHA
IDENTIFICATION : 4VR-1 4VR-2
4VR-F

1B1F-2118G-00

Be a Responsible Owner

As the vehicle's owner, you are responsible for the safe and proper operation of your motorcycle.

Motorcycles are single-track vehicles. Their safe use and operation are dependent upon the use of proper riding techniques as well as the expertise of the operator. Every operator should know the following requirements before riding this motorcycle.

He or she should:

- Obtain thorough instructions from a competent source on all aspects of motorcycle operation.
- Observe the warnings and maintenance requirements in this Owner's Manual.
- Obtain qualified training in safe and proper riding techniques.
- Obtain professional technical service as indicated in this Owner's Manual and/or when made necessary by mechanical conditions.

Safe Riding

Perform the pre-operation checks each time you use the vehicle to make sure it is in safe operating condition. Failure to inspect or maintain the vehicle properly increases the possibility of an accident or equipment damage. See page 5-1 for a list of pre-operation checks.

- This motorcycle is designed to carry the operator and a passenger.
- The failure of motorists to detect and recognize motorcycles in traffic is the predominating cause of automobile/motorcycle accidents. Many accidents have been caused by an automobile driver who did not see the motorcycle. Making yourself conspicuous appears to be very effective in reducing the chance of this type of accident.

Therefore:

- Wear a brightly colored jacket.
- Use extra caution when you are approaching and passing through intersections, since intersections are the most likely places for motorcycle accidents to occur.

- Ride where other motorists can see you. Avoid riding in another motorist's blind spot.
- Many accidents involve inexperienced operators. In fact, many operators who have been involved in accidents do not even have a current motorcycle license.
- Make sure that you are qualified and that you only lend your motorcycle to other qualified operators.
- Know your skills and limits. Staying within your limits may help you to avoid an accident.
- We recommend that you practice riding your motorcycle where there is no traffic until you have become thoroughly familiar with the motorcycle and all of its controls.
- Many accidents have been caused by error of the motorcycle operator. A typical error made by the operator is veering wide on a turn

due to excessive speed or undercornering (insufficient lean angle for the speed).

- Always obey the speed limit and never travel faster than warranted by road and traffic conditions.
- Always signal before turning or changing lanes. Make sure that other motorists can see you.
- The posture of the operator and passenger is important for proper control.
 - The operator should keep both hands on the handlebar and both feet on the operator footrests during operation to maintain control of the motorcycle.
 - The passenger should always hold onto the operator, the seat strap or grab bar, if equipped, with both hands and keep both feet on the passenger footrests. Never carry a passenger unless he or she can firmly place both feet on the passenger footrests.
- Never ride under the influence of alcohol or other drugs.

- This motorcycle is designed for on-road use only. It is not suitable for off-road use.

Protective apparel

The majority of fatalities from motorcycle accidents are the result of head injuries. The use of a safety helmet is the single most critical factor in the prevention or reduction of head injuries.

- Always wear an approved helmet.
- Wear a face shield or goggles. Wind in your unprotected eyes could contribute to an impairment of vision that could delay seeing a hazard.
- The use of a jacket, heavy boots, trousers, gloves, etc., is effective in preventing or reducing abrasions or lacerations.
- Never wear loose-fitting clothes, otherwise they could catch on the control levers, footrests, or wheels and cause injury or an accident.
- Always wear protective clothing that covers your legs, ankles, and feet. The engine or exhaust system become very hot during or after operation and can cause burns.

- A passenger should also observe the above precautions.

Avoid Carbon Monoxide Poisoning

All engine exhaust contains carbon monoxide, a deadly gas. Breathing carbon monoxide can cause headaches, dizziness, drowsiness, nausea, confusion, and eventually death.

Carbon Monoxide is a colorless, odorless, tasteless gas which may be present even if you do not see or smell any engine exhaust. Deadly levels of carbon monoxide can collect rapidly and you can quickly be overcome and unable to save yourself. Also, deadly levels of carbon monoxide can linger for hours or days in enclosed or poorly ventilated areas. If you experience any symptoms of carbon monoxide poisoning, leave the area immediately, get fresh air, and **SEEK MEDICAL TREATMENT**.

- Do not run engine indoors. Even if you try to ventilate engine exhaust with fans or open windows and doors, carbon monoxide can rapidly reach dangerous levels.

SAFETY INFORMATION

2

- Do not run engine in poorly ventilated or partially enclosed areas such as barns, garages, or carports.
- Do not run engine outdoors where engine exhaust can be drawn into a building through openings such as windows and doors.

Loading

Adding accessories or cargo to your motorcycle can adversely affect stability and handling if the weight distribution of the motorcycle is changed. To avoid the possibility of an accident, use extreme caution when adding cargo or accessories to your motorcycle. Use extra care when riding a motorcycle that has added cargo or accessories. Here, along with the information about accessories below, are some general guidelines to follow if loading cargo to your motorcycle:

The total weight of the operator, passenger, accessories and cargo must not exceed the maximum load limit.

Operation of an overloaded vehicle could cause an accident.

Maximum load:

XVS650AZ 200 kg (441 lb)

XVS650Z 180 kg (397 lb)

When loading within this weight limit, keep the following in mind:

- Cargo and accessory weight should be kept as low and close to the motorcycle as possible. Securely pack your heaviest items as close to the center of the vehicle as possible and make sure to distribute the weight as evenly as possible on both sides of the motorcycle to minimize imbalance or instability.
- Shifting weights can create a sudden imbalance. Make sure that accessories and cargo are securely attached to the motorcycle before riding. Check accessory mounts and cargo restraints frequently.
 - Properly adjust the suspension for your load (suspension-adjustable models only), and check the condition and pressure of your tires.

- Never attach any large or heavy items to the handlebar, front fork, or front fender. These items, including such cargo as sleeping bags, duffel bags, or tents, can create unstable handling or a slow steering response.
- **This vehicle is not designed to pull a trailer or to be attached to a sidecar.**

Genuine Yamaha Accessories

Choosing accessories for your vehicle is an important decision. Genuine Yamaha accessories, which are available only from a Yamaha dealer, have been designed, tested, and approved by Yamaha for use on your vehicle.

Many companies with no connection to Yamaha manufacture parts and accessories or offer other modifications for Yamaha vehicles. Yamaha is not in a position to test the products that these aftermarket companies produce. Therefore, Yamaha can neither endorse nor recommend the use of accessories not sold by Yamaha or

modifications not specifically recommended by Yamaha, even if sold and installed by a Yamaha dealer.

Aftermarket Parts, Accessories, and Modifications

While you may find aftermarket products similar in design and quality to genuine Yamaha accessories, recognize that some aftermarket accessories or modifications are not suitable because of potential safety hazards to you or others. Installing aftermarket products or having other modifications performed to your vehicle that change any of the vehicle's design or operation characteristics can put you and others at greater risk of serious injury or death. You are responsible for injuries related to changes in the vehicle.

Keep the following guidelines in mind, as well as those provided under "Loading" when mounting accessories.

- Never install accessories or carry cargo that would impair the performance of your motorcycle. Carefully inspect the accessory before using it to make sure that it does not in any way reduce ground

clearance or cornering clearance, limit suspension travel, steering travel or control operation, or obscure lights or reflectors.

- Accessories fitted to the handlebar or the front fork area can create instability due to improper weight distribution or aerodynamic changes. If accessories are added to the handlebar or front fork area, they must be as lightweight as possible and should be kept to a minimum.
- Bulky or large accessories may seriously affect the stability of the motorcycle due to aerodynamic effects. Wind may attempt to lift the motorcycle, or the motorcycle may become unstable in cross winds. These accessories may also cause instability when passing or being passed by large vehicles.
- Certain accessories can displace the operator from his or her normal riding position. This improper position limits the freedom of movement of the opera-

tor and may limit control ability, therefore, such accessories are not recommended.

- Use caution when adding electrical accessories. If electrical accessories exceed the capacity of the motorcycle's electrical system, an electric failure could result, which could cause a dangerous loss of lights or engine power.

Aftermarket Tires and Rims

The tires and rims that came with your motorcycle were designed to match the performance capabilities and to provide the best combination of handling, braking, and comfort. Other tires, rims, sizes, and combinations may not be appropriate. Refer to page 7-16 for tire specifications and more information on replacing your tires.

DESCRIPTION

EAU10410

Left view

3

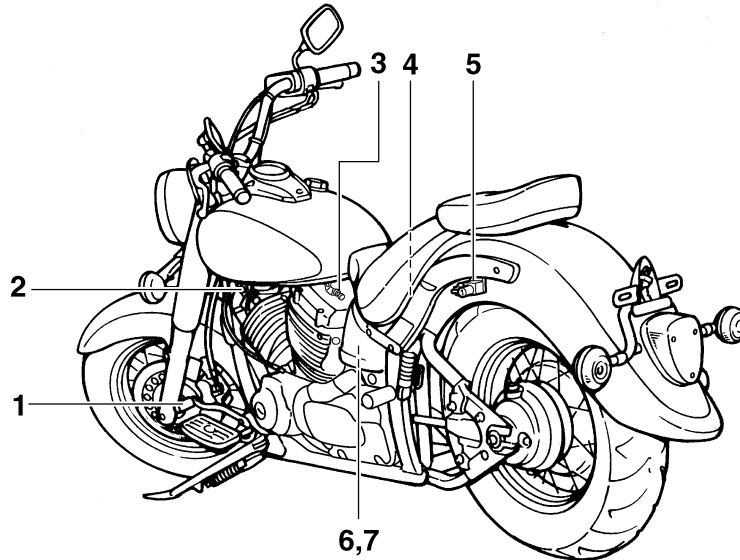

1. Shift pedal (page 4-8)
2. Fuel cock (page 4-11)
3. Starter (choke) knob (page 4-12)
4. Shock absorber assembly spring preload adjusting ring (page 4-16)
5. Helmet holder (page 4-15)
6. Storage compartment (page 4-15)
7. Owner's tool kit (page 7-1)

Right view

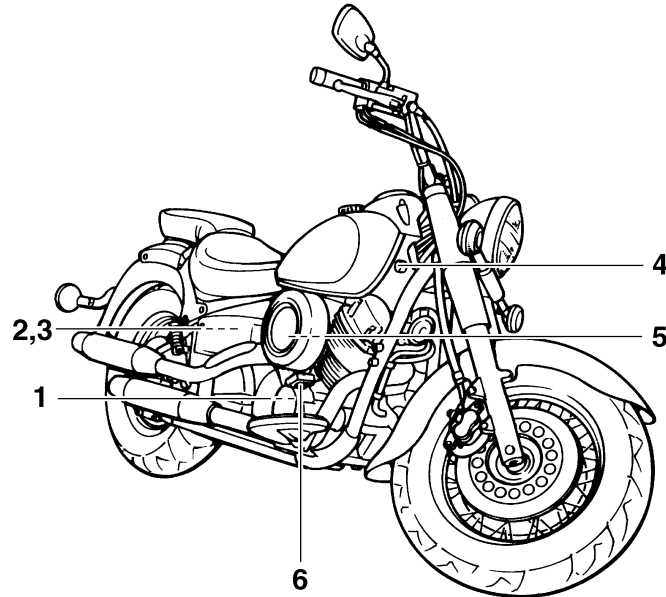

1. Engine oil filter element (page 7-9)
2. Battery (page 7-27)
3. Fuses (page 7-29)
4. Main switch/steering lock (page 4-2)
5. Air filter element (page 7-13)
6. Brake pedal (page 4-9)

DESCRIPTION

EAU10430

Controls and instruments

3

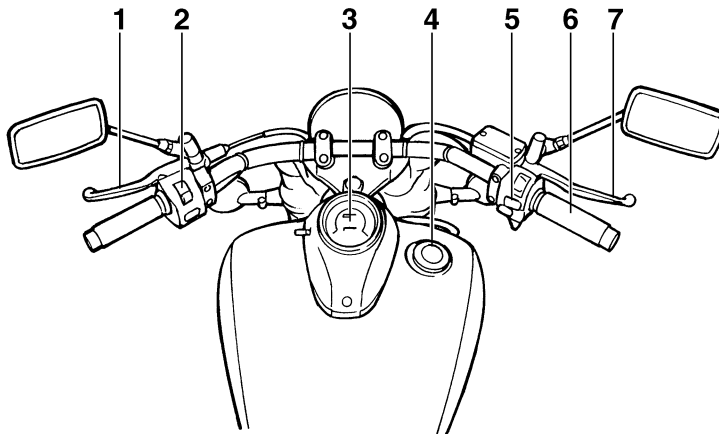

1. Clutch lever (page 4-7)
2. Left handlebar switches (page 4-6)
3. Speedometer unit (page 4-5)
4. Fuel tank cap (page 4-9)
5. Right handlebar switches (page 4-6)
6. Throttle grip (page 7-15)
7. Brake lever (page 4-8)

Immobilizer system (XVS650AZ)

EAU26892

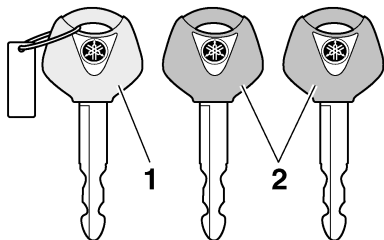

1. Code re-registering key (red bow)
2. Standard keys (black bow)

This vehicle is equipped with an immobilizer system to help prevent theft by re-registering codes in the standard keys. This system consists of the following:

- a code re-registering key (with a red bow)
- two standard keys (with a black bow) that can be re-registered with new codes
- a transponder (which is installed in the code re-registering key)
- an immobilizer unit
- the ignitor unit

- an immobilizer system indicator light (See page 4-4.)
- The key with the red bow is used to register codes in each standard key. Since re-registering is a difficult process, take the vehicle along with all three keys to a Yamaha dealer to have them re-registered. Do not use the key with the red bow for driving. It should only be used for re-registering the standard keys. Always use a standard key for driving.

ECA11821

NOTICE

- **DO NOT LOSE THE CODE RE-REGISTERING KEY! CONTACT YOUR DEALER IMMEDIATELY IF IT IS LOST! If the code re-registering key is lost, registering new codes in the standard keys is impossible. The standard keys can still be used to start the vehicle, however if code re-registering is required (i.e., if a new standard key is made or all keys are lost) the entire immobilizer system must be replaced. Therefore, it is highly recom-**

mended to use either standard key and keep the code re-registering key in a safe place.

- Do not submerge any key in water.
- Do not expose any key to excessively high temperatures.
- Do not place any key close to magnets (this includes, but not limited to, products such as speakers, etc.).
- Do not place items that transmit electrical signals close to any key.
- Do not place heavy items on any key.
- Do not grind any key or alter its shape.
- Do not disassemble the plastic part of any key.
- Do not put two keys of any immobilizer system on the same key ring.
- Keep the standard keys as well as keys of other immobilizer systems away from this vehicle's code re-registering key.

INSTRUMENT AND CONTROL FUNCTIONS

- Keep other immobilizer system keys away from the main switch as they may cause signal interference.

4

Main switch/steering lock (XVS650Z)

EAU10460

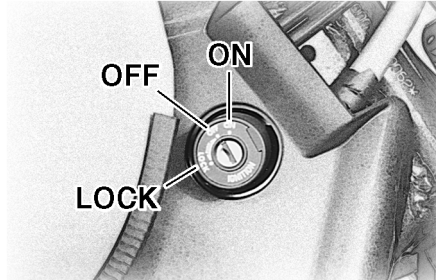

The main switch/steering lock controls the ignition and lighting systems, and is used to lock the steering. The various positions are described below.

Main switch/steering lock (XVS650AZ)

EAU10471

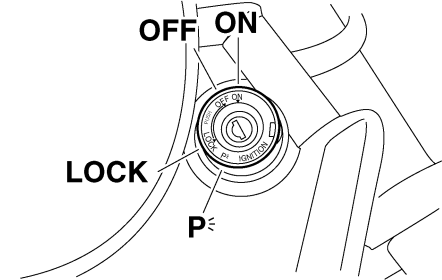

The main switch/steering lock controls the ignition and lighting systems, and is used to lock the steering.

TIP

Be sure to use the standard key (black bow) for regular use of the vehicle. To minimize the risk of losing the code re-registering key (red bow), keep it in a safe place and only use it for code re-registering.

INSTRUMENT AND CONTROL FUNCTIONS

ON (XVS650Z)

EAU10480

All electrical systems are supplied with power, and the headlight, meter lighting and taillight come on, and the engine can be started. The key cannot be removed.

ON (XVS650AZ)

EAU33590

All electrical circuits are supplied with power; the meter lighting, taillight and auxiliary light come on, and the engine can be started. The key cannot be removed.

TIP

The headlight comes on automatically when the engine is started and stays on until the key is turned to “OFF”, even if the engine stalls.

OFF

EAU10661

All electrical systems are off. The key can be removed.

WARNING

EWA10061

Never turn the key to “OFF” or “LOCK” while the vehicle is moving. Otherwise the electrical systems will be switched off, which may result in loss of control or an accident.

LOCK

EAU10681

The steering is locked, and all electrical systems are off. The key can be removed.

To lock the steering

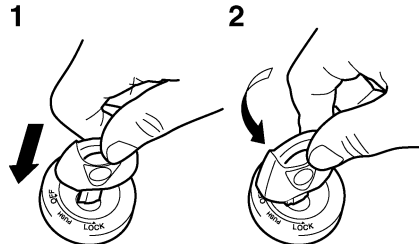

1. Push.
2. Turn.

1. Turn the handlebars all the way to the left.

2. Push the key in from the “OFF” position, and then turn it to “LOCK” while still pushing it.
3. Remove the key.

To unlock the steering

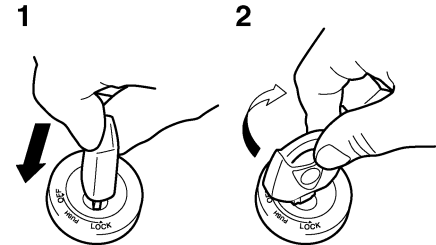

1. Push.
2. Turn.

Push the key in, and then turn it to “OFF” while still pushing it.

(Parking) (XVS650AZ)

EAU33001

The steering is locked, and the taillight and auxiliary light are on. The hazard lights and turn signal lights can be turned on, but all other electrical systems are off. The key can be removed.

INSTRUMENT AND CONTROL FUNCTIONS

The steering must be locked before the key can be turned to “P”.

ECA11020



NOTICE

Do not use the parking position for an extended length of time, otherwise the battery may discharge.

Indicator and warning lights

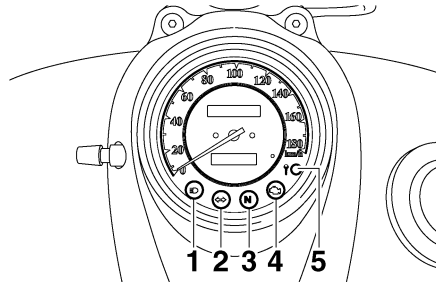
EAU11004



1. High beam indicator light “”
2. Turn signal indicator light “”
3. Neutral indicator light “**N**”
4. Engine trouble warning light “”
5. Immobilizer system indicator light (XVS650AZ)

EAU11020

Turn signal indicator light “”

This indicator light flashes when the turn signal switch is pushed to the left or right.

EAU11060

Neutral indicator light “**N**”

This indicator light comes on when the transmission is in the neutral position.

High beam indicator light “”

EAU11080

This indicator light comes on when the high beam of the headlight is switched on.

Engine trouble warning light “”

EAU11505

This warning light comes on or flashes if a problem is detected in the electrical circuit monitoring the engine. If this occurs, have a Yamaha dealer check the self-diagnosis system. (See page 4-6 for an explanation of the self-diagnosis device.)

The electrical circuit of the warning light can be checked by turning the key to “ON”. The warning light should come on for a few seconds, and then go off.

If the warning light does not come on initially when the key is turned to “ON”, or if the warning light remains on, have a Yamaha dealer check the electrical circuit.

Immobilizer system indicator light (XVS650AZ)

EAU38913

The electrical circuit of the indicator light can be checked by turning the key to “ON”. The indicator light should come on for a few seconds, and then go off.

If the indicator light does not come on initially when the key is turned to “ON”, or if the indicator light remains on, have a Yamaha dealer check the electrical circuit.

When the key is turned to “OFF” and 30 seconds have passed, the indicator light will start flashing indicating the immobilizer system is enabled. After 24 hours have passed, the indicator light will stop flashing, however the immobilizer system is still enabled.

TIP

This model is also equipped with a self-diagnosis device for the immobilizer system. If the immobilizer system is not working correctly, the indicator light will start flashing a pattern when the key is turned to “ON”. When this occurs, have a Yamaha dealer check the self-diagnosis system. However, if the indicator

light slowly flashes five times, and then quickly flashes two times repeatedly, this error could be caused by signal interference. If this occurs, try the following.

1. Use the code re-registering key to start the engine.

TIP

Make sure there are no other immobilizer keys close to the main switch, and do not keep more than one immobilizer key on the same key ring! Immobilizer system keys may cause signal interference, which may prevent the engine from starting.

2. If the engine starts, turn it off, and try starting the engine with the standard keys.
3. If one or both of the standard keys do not start the engine, take the vehicle, the code re-registering key and both standard keys to a Yamaha dealer and have the standard keys re-registered.

Speedometer unit

EAU11630

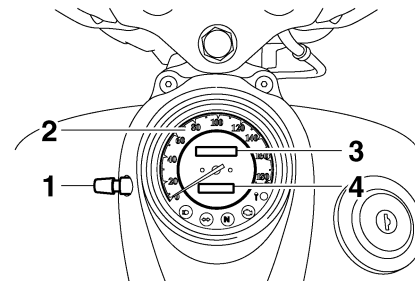

1. Tripmeter reset knob
2. Speedometer
3. Odometer
4. Tripmeter

The speedometer unit is equipped with a speedometer, an odometer and a tripmeter. The speedometer shows riding speed. The odometer shows the total distance traveled. The tripmeter shows the distance traveled since it was last set to zero with the reset knob. The tripmeter can be used to estimate the distance that can be traveled with a full tank of fuel. This information will enable you to plan future fuel stops.

INSTRUMENT AND CONTROL FUNCTIONS

Self-diagnosis device

EAU12092

This model is equipped with a self-diagnosis device for various electrical circuits.

If a problem is detected in any of those circuits, the engine trouble warning light will come on or flash. If this occurs, have a Yamaha dealer check the vehicle.

ECA11170

4 NOTICE

To prevent engine damage, be sure to consult a Yamaha dealer as soon as possible if this occurs.

Handlebar switches

EAU12348

Left

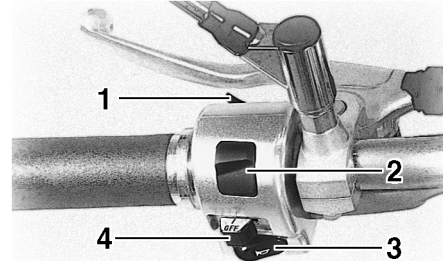

1. Pass switch “ $\equiv \text{D}$ ”
2. Dimmer switch “ $\equiv \text{D} / \equiv \text{D}$ ”
3. Horn switch “ H ”
4. Turn signal switch “ \leftarrow / \rightarrow ”

Right (XVS650Z)

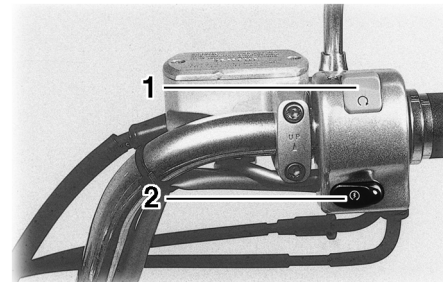

1. Engine stop switch “ \bigcirc / X ”
2. Start switch “ S ”

Right (XVS650AZ)

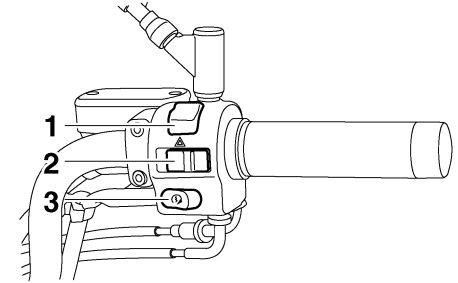

1. Engine stop switch “ \bigcirc / X ”
2. Hazard switch “ \triangle ”
3. Start switch “ S ”

Pass switch “ $\equiv \text{D}$ ”

EAU12350

Press this switch to flash the headlight.

Dimmer switch “ $\equiv \text{D} / \equiv \text{D}$ ”

EAU12400

Set this switch to “ $\equiv \text{D}$ ” for the high beam and to “ $\equiv \text{D}$ ” for the low beam.

Turn signal switch “ \leftarrow / \rightarrow ”

EAU12460

To signal a right-hand turn, push this switch to “ \rightarrow ”. To signal a left-hand turn, push this switch to “ \leftarrow ”. When released, the switch returns to the center

position. To cancel the turn signal lights, push the switch in after it has returned to the center position.



EAU12500

Horn switch “”

Press this switch to sound the horn.

Engine stop switch “”

EAU12660

Set this switch to “” before starting the engine. Set this switch to “” to stop the engine in case of an emergency, such as when the vehicle overturns or when the throttle cable is stuck.

EAU12711

Start switch “”

Push this switch to crank the engine with the starter. See page 6-1 for starting instructions prior to starting the engine.

EAU12733

Hazard switch “” (XVS650AZ)

With the key in the “ON” or “” position, use this switch to turn on the hazard lights (simultaneous flashing of all turn signal lights).

The hazard lights are used in case of an emergency or to warn other drivers when your vehicle is stopped where it might be a traffic hazard.

ECA10061

NOTICE

Do not use the hazard lights for an extended length of time with the engine not running, otherwise the battery may discharge.

Clutch lever

EAU12820

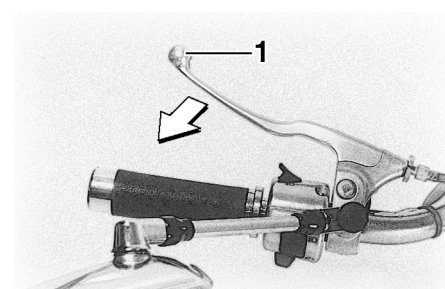

1. Clutch lever

The clutch lever is located at the left handlebar grip. To disengage the clutch, pull the lever toward the handlebar grip. To engage the clutch, release the lever. The lever should be pulled rapidly and released slowly for smooth clutch operation.

The clutch lever is equipped with a clutch switch, which is part of the ignition circuit cut-off system. (See page 4-18.)

INSTRUMENT AND CONTROL FUNCTIONS

Shift pedal (XVS650Z)

EAU12870

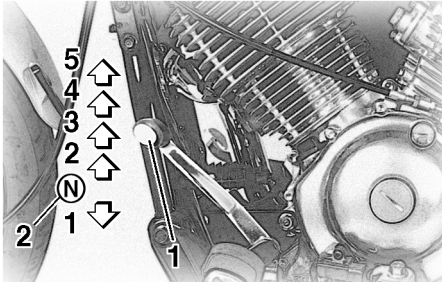

1. Shift pedal
2. Neutral position

The shift pedal is located on the left side of the engine and is used in combination with the clutch lever when shifting the gears of the 5-speed constant-mesh transmission equipped on this motorcycle.

Shift pedal (XVS650AZ)

EAU12880

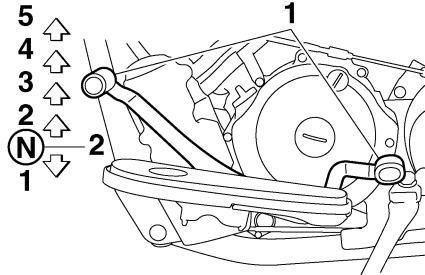

1. Shift pedal
2. Neutral position

The shift pedal is located on the left side of the engine and is used in combination with the clutch lever when shifting the gears of the 5-speed constant-mesh transmission equipped on this motorcycle.

TIP

Use your toes or heel to shift up and your toes to shift down.

Brake lever

EAU12890

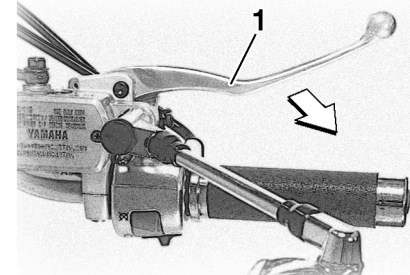

1. Brake lever

The brake lever is located at the right handlebar grip. To apply the front brake, pull the lever toward the handlebar grip.

INSTRUMENT AND CONTROL FUNCTIONS

Brake pedal

EAU12941

XVS650Z

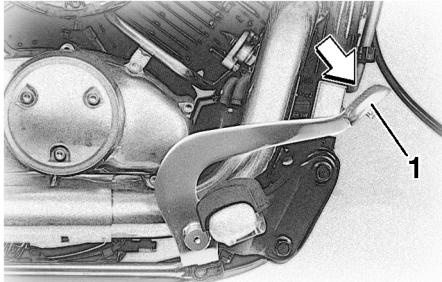

1. Brake pedal

XVS650AZ

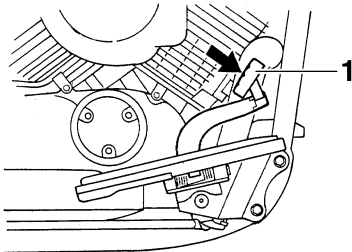

1. Brake pedal

The brake pedal is on the right side of the motorcycle. To apply the rear brake, press down on the brake pedal.

Fuel tank cap

EAU13121

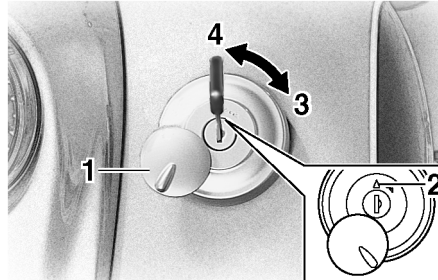

1. Fuel tank cap lock cover
2. “△” mark
3. Unlock.
4. Lock.

To remove the fuel tank cap

Slide the lock cover open, insert the key into the lock, and then turn it 1/4 turn clockwise. The lock will be released and the fuel tank cap can be removed.

To install the fuel tank cap

1. Insert the fuel tank cap into the tank opening with the key inserted in the lock and with the “△” mark facing forward.

2. Turn the key counterclockwise to the original position, remove it, and then close the lock cover.

TIP

The fuel tank cap cannot be installed unless the key is in the lock. In addition, the key cannot be removed if the cap is not properly installed and locked.

EWA10131

WARNING

Make sure that the fuel tank cap is properly installed before riding. Leaking fuel is a fire hazard.

INSTRUMENT AND CONTROL FUNCTIONS

Fuel

EAU13212

Make sure there is sufficient gasoline in the tank.

EWA10881

WARNING

Gasoline and gasoline vapors are extremely flammable. To avoid fires and explosions and to reduce the risk of injury when refueling, follow these instructions.

4

1. Before refueling, turn off the engine and be sure that no one is sitting on the vehicle. Never refuel while smoking, or while in the vicinity of sparks, open flames, or other sources of ignition such as the pilot lights of water heaters and clothes dryers.
2. Do not overfill the fuel tank. Stop filling when the fuel reaches the bottom of the filler tube. Because fuel expands when it heats up, heat from the engine or the sun can cause fuel to spill out of the fuel tank.

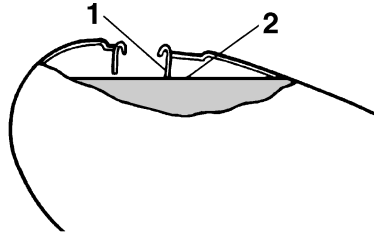

1. Fuel tank filler tube
2. Fuel level

3. Wipe up any spilled fuel immediately. **NOTICE: Immediately wipe off spilled fuel with a clean, dry, soft cloth, since fuel may deteriorate painted surfaces or plastic parts.** (ECA10071)
4. Be sure to securely close the fuel tank cap.

EWA15151

WARNING

Gasoline is poisonous and can cause injury or death. Handle gasoline with care. Never siphon gasoline by mouth. If you should swallow some gasoline or inhale a lot of gasoline vapor, or get some gasoline in your eyes, see your doctor immedi-

ately. If gasoline spills on your skin, wash with soap and water. If gasoline spills on your clothing, change your clothes.

EAU13332

Recommended fuel:
UNLEADED GASOLINE ONLY
Fuel tank capacity:
16.0 L (4.23 US gal, 3.52 Imp.gal)
Fuel reserve amount:
3.0 L (0.79 US gal, 0.66 Imp.gal)

ECA11400

NOTICE

Use only unleaded gasoline. The use of leaded gasoline will cause severe damage to internal engine parts, such as the valves and piston rings, as well as to the exhaust system.

Your Yamaha engine has been designed to use regular unleaded gasoline with a research octane number of 91 or higher. If knocking (or pinging) occurs, use a gasoline of a different brand or premium unleaded fuel. Use of unleaded fuel will extend spark plug life and reduce maintenance costs.

INSTRUMENT AND CONTROL FUNCTIONS

EAU13550

Fuel cock

The fuel cock supplies fuel from the tank to the carburetors while also filtering it.

The fuel cock lever positions are explained as follows and shown in the illustrations.

OFF

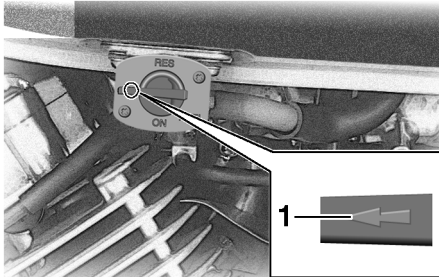

1. Arrow mark positioned over "OFF"

With the fuel cock lever in this position, fuel will not flow. Always turn the fuel cock lever to this position when the engine is not running.

ON

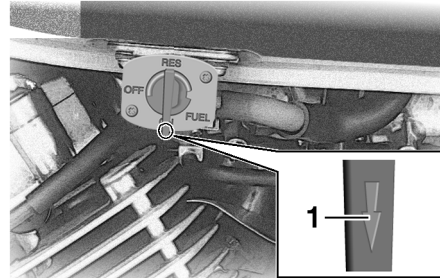

1. Arrow mark positioned over "ON"

With the fuel cock lever in this position, fuel flows to the carburetors. Turn the fuel cock lever to this position when starting the engine and riding.

RES

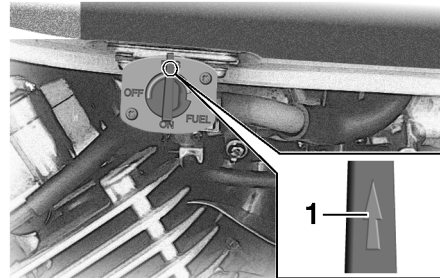



1. Arrow mark positioned over "RES"

This indicates reserve. With the fuel cock lever in this position, the fuel reserve is made available. Turn the fuel cock lever to this position if you run out of fuel while riding. When this occurs, refuel as soon as possible and be sure to turn the fuel cock lever back to "ON"!

INSTRUMENT AND CONTROL FUNCTIONS

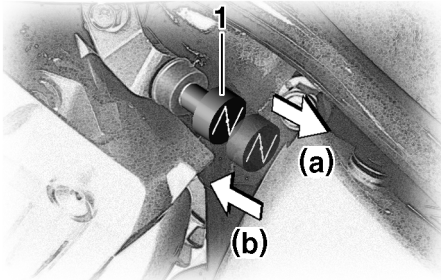
Starter (choke) knob “” EAU13620



1. Starter (choke) knob “”

Starting a cold engine requires a richer air-fuel mixture, which is supplied by the starter (choke).

Move the knob in direction (a) to turn on the starter (choke).

Move the knob in direction (b) to turn off the starter (choke).

ECA10990

NOTICE

Do not use the starter (choke) for more than 3 minutes as the exhaust pipe may discolor from excessive heat. In addition, extended use of the starter (choke) will cause after-burning. If this occurs, turn off the starter (choke).

Seats (XVS650Z) EAU14184

Passenger seat

To remove the passenger seat
Remove the nut and washer, and then pull the passenger seat up.

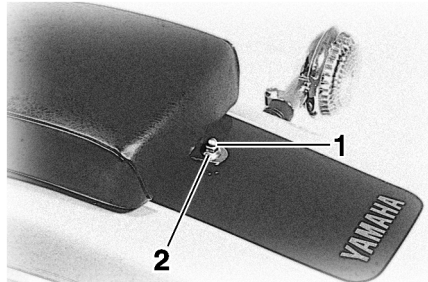

1. Nut
2. Washer

To install the passenger seat

1. Insert the projection on the front of the passenger seat into the seat holder as shown and place the seat in the original position.
2. Install the washer and nut, and then tighten the nut to the specified torque.

Tightening torque:

Passenger seat nut:
13 Nm (1.3 m·kgf, 9.4 ft·lbf)

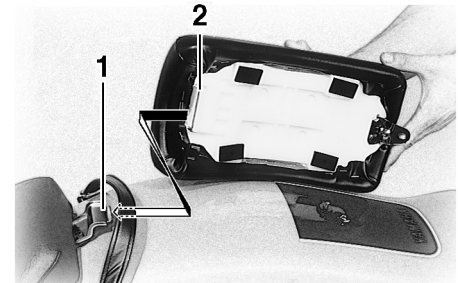

1. Passenger seat holder
2. Projection

Rider seat

To remove the rider seat

1. Remove the passenger seat.
2. Remove the passenger seat holder by removing its bolts, and then pull the rider seat up.

INSTRUMENT AND CONTROL FUNCTIONS

EAU14192

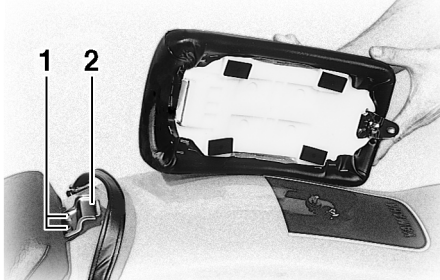

1. Bolt
2. Passenger seat holder

To install the rider seat

1. Insert the projection on the front of the rider seat into the seat holder as shown, and then place the seat in the original position.

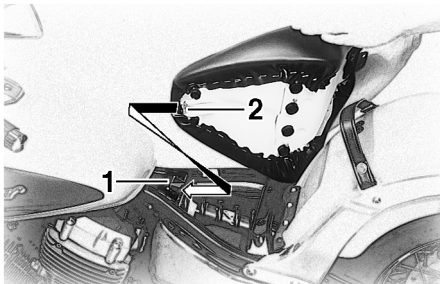

1. Seat holder
2. Projection

2. Install the passenger seat holder by installing its bolts.
3. Install the passenger seat.

TIP _____

Make sure that the seats are properly secured before riding.

Seats (XVS650AZ)

Passenger seat

To remove the passenger seat
Remove the nut and washer, and then pull the passenger seat up.

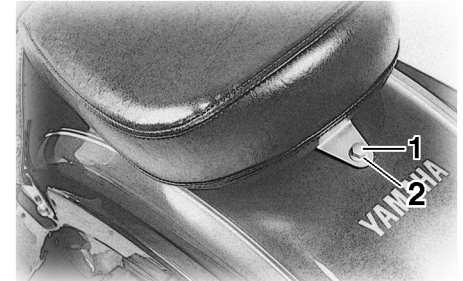

1. Nut
2. Washer

To install the passenger seat

1. Insert the projections on the front of the passenger seat into the holders as shown and place the seat in the original position.
2. Install the washer and nut, and then tighten the nut to the specified torque.

INSTRUMENT AND CONTROL FUNCTIONS

Tightening torque:

Passenger seat nut:
13 Nm (1.3 m·kgf, 9.4 ft·lbf)

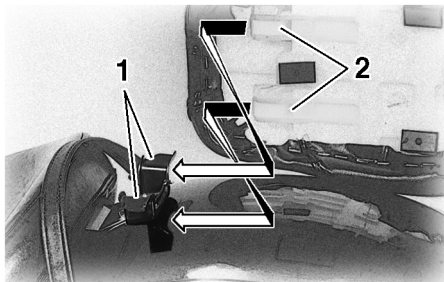

1. Passenger seat holder
2. Projection

Rider seat

To remove the rider seat

1. Remove the passenger seat.
2. Remove the bolt, and then pull the rider seat up.

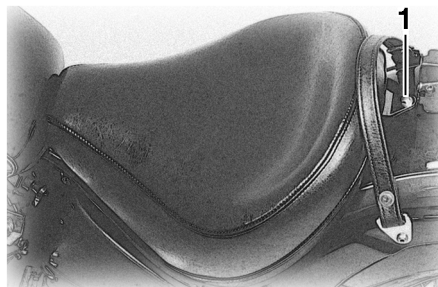

1. Bolt

To install the rider seat

1. Insert the projection on the front of the rider seat into the holder as shown, place the seat in the original position, and then install the bolt.

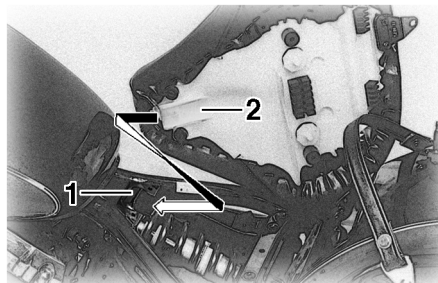

1. Seat holder
2. Projection

2. Install the passenger seat.

TIP

Make sure that the seats are properly secured before riding.

Helmet holder

EAU14282

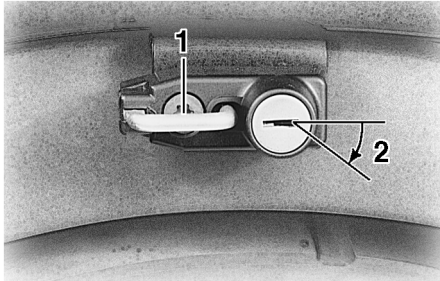

1. Helmet holder
2. Unlock.

To open the helmet holder, insert the key into the lock, and then turn the key as shown.

To lock the helmet holder, place it in the original position, and then remove the key. **WARNING! Never ride with a helmet attached to the helmet holder, since the helmet may hit objects, causing loss of control and possibly an accident.** [EWA10161]

Storage compartment

EAU14481

The storage compartment is located on the left side of the vehicle.

To open the storage compartment

1. Slide the lock cover open, insert the key into the lock, and then turn it clockwise.

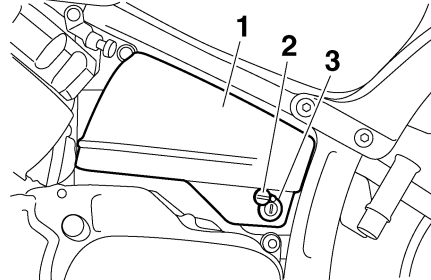

1. Storage compartment cover
2. Storage compartment lock cover
3. Storage compartment lock

2. Pull the storage compartment cover out as shown.

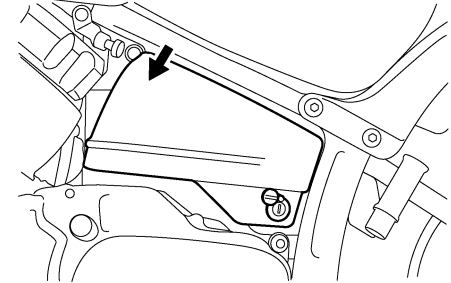

To close the storage compartment

1. Place the storage compartment cover in its original position as shown.

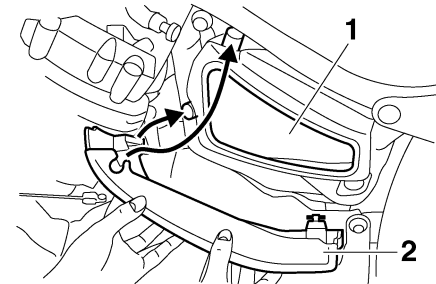

1. Storage compartment
2. Storage compartment cover

2. Turn the key counterclockwise, remove it, and then close the lock cover.

INSTRUMENT AND CONTROL FUNCTIONS

Adjusting the shock absorber assembly

EAU14863

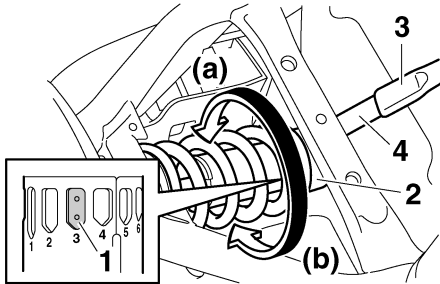

1. Position indicator
2. Spring preload adjusting ring
3. Extension bar
4. Special wrench

This shock absorber assembly is equipped with a spring preload adjusting ring.

ECA10101

NOTICE

To avoid damaging the mechanism, do not attempt to turn beyond the maximum or minimum settings.

Adjust the spring preload as follows.

1. Remove the passenger and rider seats. (See page 4-12.)

2. To increase the spring preload and thereby harden the suspension, turn the adjusting ring in direction (a). To decrease the spring preload and thereby soften the suspension, turn the adjusting ring in direction (b).

- Align the appropriate notch in the adjusting ring with the position indicator on the shock absorber.
- Use the special wrench and extension bar included in the owner's tool kit to make the adjustment.

Spring preload setting:

Minimum (soft):
1
Standard:
3
Maximum (hard):
7

3. Install the passenger and rider seats.

EWA10221

WARNING

This shock absorber assembly contains highly pressurized nitrogen gas. Read and understand the following information before handling the shock absorber assembly.

- Do not tamper with or attempt to open the cylinder assembly.
- Do not subject the shock absorber assembly to an open flame or other high heat source. This may cause the unit to explode due to excessive gas pressure.
- Do not deform or damage the cylinder in any way. Cylinder damage will result in poor damping performance.
- Do not dispose of a damaged or worn-out shock absorber assembly yourself. Take the shock absorber assembly to a Yamaha dealer for any service.

Luggage strap holders

EAU15151

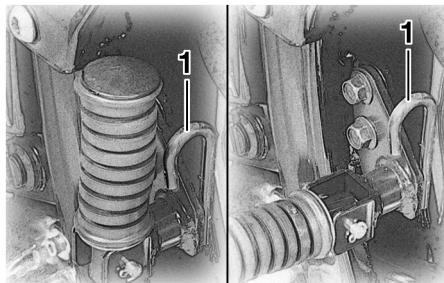

1. Luggage strap holder

There is a luggage strap holder on each passenger footrest.

Sidestand

EAU15303

The sidestand is located on the left side of the frame. Raise the sidestand or lower it with your foot while holding the vehicle upright.

TIP

The built-in sidestand switch is part of the ignition circuit cut-off system, which cuts the ignition in certain situations. (See page 4-18 for an explanation of the ignition circuit cut-off system.)

EWA10240

WARNING

The vehicle must not be ridden with the sidestand down, or if the sidestand cannot be properly moved up (or does not stay up), otherwise the sidestand could contact the ground and distract the operator, resulting in a possible loss of control. Yamaha's ignition circuit cut-off system has been designed to assist the operator in fulfilling the responsibility of raising the sidestand before starting off. Therefore, check this system regularly as described

below and have a Yamaha dealer repair it if it does not function properly.

INSTRUMENT AND CONTROL FUNCTIONS

EAU15314

Ignition circuit cut-off system

The ignition circuit cut-off system (comprising the sidestand switch, clutch switch and neutral switch) has the following functions.

- It prevents starting when the transmission is in gear and the sidestand is up, but the clutch lever is not pulled.
- It prevents starting when the transmission is in gear and the clutch lever is pulled, but the sidestand is still down.
- It cuts the running engine when the transmission is in gear and the sidestand is moved down.

Periodically check the operation of the ignition circuit cut-off system according to the following procedure.

TIP

This check is most reliable if performed with a warmed-up engine.

INSTRUMENT AND CONTROL FUNCTIONS

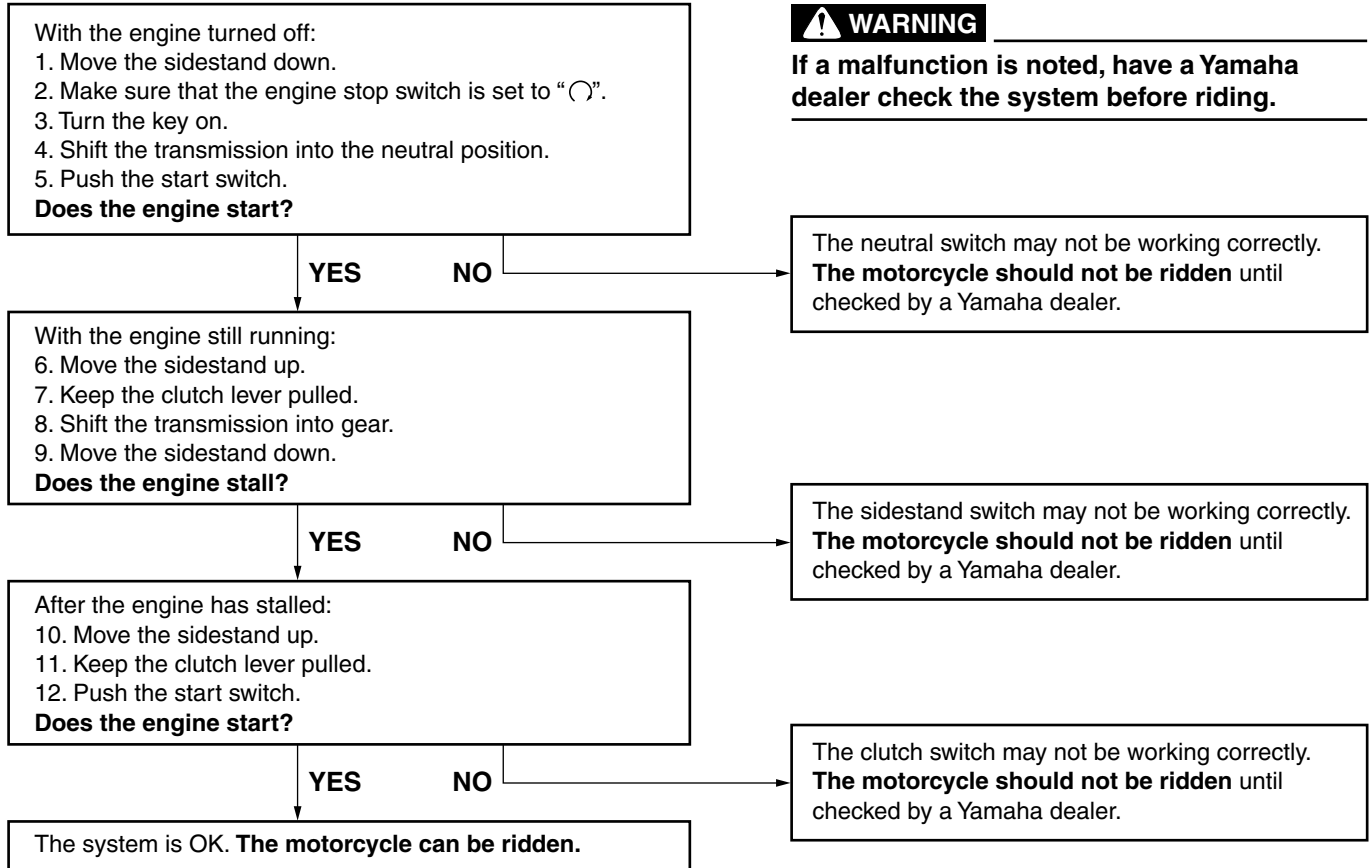

FOR YOUR SAFETY – PRE-OPERATION CHECKS

EAU15596

Inspect your vehicle each time you use it to make sure the vehicle is in safe operating condition. Always follow the inspection and maintenance procedures and schedules described in the Owner's Manual.

EWA11151

WARNING

Failure to inspect or maintain the vehicle properly increases the possibility of an accident or equipment damage. Do not operate the vehicle if you find any problem. If a problem cannot be corrected by the procedures provided in this manual, have the vehicle inspected by a Yamaha dealer.

Before using this vehicle, check the following points:

ITEM	CHECKS	PAGE
Fuel	<ul style="list-style-type: none">• Check fuel level in fuel tank.• Refuel if necessary.• Check fuel line for leakage.	4-10
Engine oil	<ul style="list-style-type: none">• Check oil level in engine.• If necessary, add recommended oil to specified level.• Check vehicle for oil leakage.	7-9
Final gear oil	<ul style="list-style-type: none">• Check vehicle for oil leakage.	7-12
Front brake	<ul style="list-style-type: none">• Check operation.• If soft or spongy, have Yamaha dealer bleed hydraulic system.• Check lever free play.• Adjust if necessary.• Check brake pads for wear.• Replace if necessary.• Check fluid level in reservoir.• If necessary, add recommended brake fluid to specified level.• Check hydraulic system for leakage.	7-19, 7-22, 7-22
Rear brake	<ul style="list-style-type: none">• Check operation.• Check pedal free play.• Adjust if necessary.	7-20, 7-22

FOR YOUR SAFETY – PRE-OPERATION CHECKS

ITEM	CHECKS	PAGE
Clutch	<ul style="list-style-type: none"> • Check operation. • Lubricate cable if necessary. • Check lever free play. • Adjust if necessary. 	7-18
Throttle grip	<ul style="list-style-type: none"> • Make sure that operation is smooth. • Check cable free play. • If necessary, have Yamaha dealer adjust cable free play and lubricate cable and grip housing. 	7-15, 7-24
Control cables	<ul style="list-style-type: none"> • Make sure that operation is smooth. • Lubricate if necessary. 	7-23
Wheels and tires	<ul style="list-style-type: none"> • Check for damage. • Check tire condition and tread depth. • Check air pressure. • Correct if necessary. 	7-16, 7-18
Brake and shift pedals	<ul style="list-style-type: none"> • Make sure that operation is smooth. • Lubricate pedal pivoting points if necessary. 	7-24
Brake and clutch levers	<ul style="list-style-type: none"> • Make sure that operation is smooth. • Lubricate lever pivoting points if necessary. 	7-25
Sidestand	<ul style="list-style-type: none"> • Make sure that operation is smooth. • Lubricate pivot if necessary. 	7-25
Chassis fasteners	<ul style="list-style-type: none"> • Make sure that all nuts, bolts and screws are properly tightened. • Tighten if necessary. 	—
Instruments, lights, signals and switches	<ul style="list-style-type: none"> • Check operation. • Correct if necessary. 	—
Sidestand switch	<ul style="list-style-type: none"> • Check operation of ignition circuit cut-off system. • If system is not working correctly, have Yamaha dealer check vehicle. 	4-17

OPERATION AND IMPORTANT RIDING POINTS

EAU15951

Read the Owner's Manual carefully to become familiar with all controls. If there is a control or function you do not understand, ask your Yamaha dealer.

EWA10271

WARNING

Failure to familiarize yourself with the controls can lead to loss of control, which could cause an accident or injury.

EAU16013

Starting and warming up a cold engine

In order for the ignition circuit cut-off system to enable starting, one of the following conditions must be met:

- The transmission is in the neutral position.
- The transmission is in gear with the clutch lever pulled and the sidestand up.
See page 4-18 for more information.

1. Turn the fuel cock lever to "ON".
2. Turn the key to "ON" and make sure that the engine stop switch is set to "○".
3. Shift the transmission into the neutral position. (See page 6-2.) The neutral indicator light should come on. If not, ask a Yamaha dealer to check the electrical circuit.
4. Turn the starter (choke) on and completely close the throttle. (See page 4-12.)
5. Start the engine by pushing the start switch.

If the engine fails to start, release the start switch, wait a few seconds, and then try again. Each starting attempt should be as short as possible to preserve the battery. Do not crank the engine more than 10 seconds on any one attempt.

6. After starting the engine, move the starter (choke) back halfway.
NOTICE: For maximum engine life, never accelerate hard when the engine is cold! [ECA11041]
7. When the engine is warm, turn the starter (choke) off.

TIP

The engine is warm when it responds normally to the throttle with the starter (choke) turned off.

OPERATION AND IMPORTANT RIDING POINTS

Starting a warm engine

EAU16640

Follow the same procedure as for starting a cold engine with the exception that the starter (choke) is not required when the engine is warm.

Shifting

EAU16671

XVS650Z

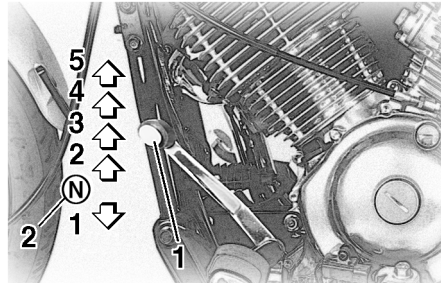

1. Shift pedal
2. Neutral position

XVS650AZ

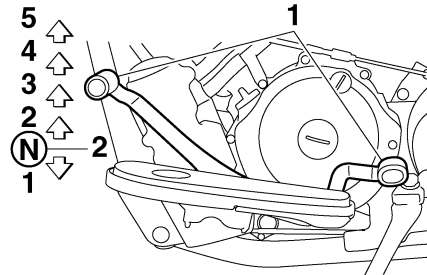

1. Shift pedal
2. Neutral position

Shifting gears lets you control the amount of engine power available for starting off, accelerating, climbing hills, etc.

The gear positions are shown in the illustration.

TIP

To shift the transmission into the neutral position, press the shift pedal down repeatedly until it reaches the end of its travel, and then slightly raise it.

ECA10260

NOTICE

- Even with the transmission in the neutral position, do not coast for long periods of time with the engine off, and do not tow the motorcycle for long distances. The transmission is properly lubricated only when the engine is running. Inadequate lubrication may damage the transmission.
- Always use the clutch while changing gears to avoid damaging the engine, transmission,

OPERATION AND IMPORTANT RIDING POINTS

and drive train, which are not designed to withstand the shock of forced shifting.

6

Tips for reducing fuel consumption

EAU16800

Fuel consumption depends largely on your riding style. Consider the following tips to reduce fuel consumption:

- Turn the starter (choke) off as soon as possible.
- Shift up swiftly, and avoid high engine speeds during acceleration.
- Do not rev the engine while shifting down, and avoid high engine speeds with no load on the engine.
- Turn the engine off instead of letting it idle for an extended length of time (e.g., in traffic jams, at traffic lights or at railroad crossings).

Engine break-in

EAU16841

There is never a more important period in the life of your engine than the period between 0 and 1600 km (1000 mi). For this reason, you should read the following material carefully.

Since the engine is brand new, do not put an excessive load on it for the first 1600 km (1000 mi). The various parts in the engine wear and polish themselves to the correct operating clearances. During this period, prolonged full-throttle operation or any condition that might result in engine overheating must be avoided.

EAU17043

0–1000 km (0–600 mi)

Avoid prolonged operation above 1/3 throttle. **NOTICE: After 1000 km (600 mi) of operation, the engine oil and final gear oil must be changed, and the oil filter cartridge or element replaced.** [ECA10332]

OPERATION AND IMPORTANT RIDING POINTS

1000–1600 km (600–1000 mi)

Avoid prolonged operation above 1/2 throttle.

1600 km (1000 mi) and beyond

The vehicle can now be operated normally.

ECA10270

NOTICE

If any engine trouble should occur during the engine break-in period, immediately have a Yamaha dealer check the vehicle.

EAU17171

Parking

When parking, stop the engine, remove the key from the main switch, and then turn the fuel cock lever to “OFF”.

EWA10311

WARNING

- Since the engine and exhaust system can become very hot, park in a place where pedestrians or children are not likely to touch them and be burned.
 - Do not park on a slope or on soft ground, otherwise the vehicle may overturn, increasing the risk of a fuel leak and fire.
 - Do not park near grass or other flammable materials which might catch fire.
-

PERIODIC MAINTENANCE AND ADJUSTMENT

EAU17241

Periodic inspection, adjustment, and lubrication will keep your vehicle in the safest and most efficient condition possible. Safety is an obligation of the vehicle owner/operator. The most important points of vehicle inspection, adjustment, and lubrication are explained on the following pages.

The intervals given in the periodic maintenance and lubrication chart should be simply considered as a general guide under normal riding conditions. However, depending on the weather, terrain, geographical location, and individual use, the maintenance intervals may need to be shortened.

EWA10321

WARNING

Failure to properly maintain the vehicle or performing maintenance activities incorrectly may increase your risk of injury or death during service or while using the vehicle. If you are not familiar with vehicle service, have a Yamaha dealer perform service.

EWA15121

WARNING

Turn off the engine when performing maintenance unless otherwise specified.

- **A running engine has moving parts that can catch on body parts or clothing and electrical parts that can cause shocks or fires.**
- **Running the engine while servicing can lead to eye injury, burns, fire, or carbon monoxide poisoning – possibly leading to death. See page 2-1 for more information about carbon monoxide.**

EAU17451

Owner's tool kit

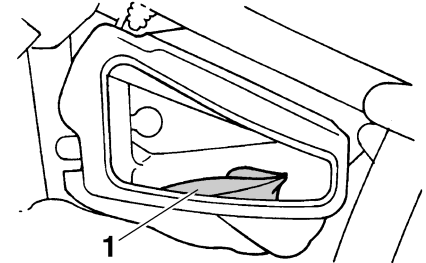

1. Owner's tool kit

The owner's tool kit is located inside the storage compartment. (See page 4-15.)

The service information included in this manual and the tools provided in the owner's tool kit are intended to assist you in the performance of preventive maintenance and minor repairs. However, additional tools such as a torque wrench may be necessary to perform certain maintenance work correctly.

TIP

If you do not have the tools or experience required for a particular job, have a Yamaha dealer perform it for you.

PERIODIC MAINTENANCE AND ADJUSTMENT

EAU46861

TIP

- The annual checks must be performed every year, except if a kilometer-based maintenance, or for the UK, a mileage-based maintenance, is performed instead.
- From 50000 km (30000 mi), repeat the maintenance intervals starting from 10000 km (6000 mi).
- Items marked with an asterisk should be performed by a Yamaha dealer as they require special tools, data and technical skills.

EAU46910

Periodic maintenance chart for the emission control system

NO.	ITEM	CHECK OR MAINTENANCE JOB	ODOMETER READING					ANNUAL CHECK
			1000 km (600 mi)	10000 km (6000 mi)	20000 km (12000 mi)	30000 km (18000 mi)	40000 km (24000 mi)	
1	* Fuel line	• Check fuel hoses for cracks or damage.		√	√	√	√	√
2	* Fuel filter	• Check condition.			√		√	
3	Spark plugs	• Check condition. • Clean and regap.		√		√		
		• Replace.			√		√	
4	* Valves	• Check valve clearance. • Adjust.		√	√	√	√	
5	* Carburetors	• Check starter (choke) operation. • Adjust engine idling speed and synchronization.	√	√	√	√	√	√
6	* Muffler and exhaust pipe	• Check the screw clamp(s) for looseness.	√	√	√	√	√	

PERIODIC MAINTENANCE AND ADJUSTMENT

EAU1770C

General maintenance and lubrication chart

NO.	ITEM	CHECK OR MAINTENANCE JOB	ODOMETER READING					ANNUAL CHECK
			1000 km (600 mi)	10000 km (6000 mi)	20000 km (12000 mi)	30000 km (18000 mi)	40000 km (24000 mi)	
1	Air filter element	• Clean.		√		√		
		• Replace.			√		√	
2	Clutch	• Check operation. • Adjust.	√	√	√	√	√	
3	* Front brake	• Check operation, fluid level and vehicle for fluid leakage. • Adjust brake lever free play.	√	√	√	√	√	√
		• Replace brake pads.	Whenever worn to the limit					
4	* Rear brake	• Check operation and adjust brake pedal free play.	√	√	√	√	√	√
		• Replace brake shoes.	Whenever worn to the limit					
5	* Brake hose	• Check for cracks or damage.		√	√	√	√	√
		• Replace.	Every 4 years					
6	* Wheels	• Check runout, spoke tightness and for damage. • Tighten spokes if necessary.		√	√	√	√	
7	* Tires	• Check tread depth and for damage. • Replace if necessary. • Check air pressure. • Correct if necessary.		√	√	√	√	√
8	* Wheel bearings	• Check bearing for looseness or damage.		√	√	√	√	

7

PERIODIC MAINTENANCE AND ADJUSTMENT

NO.	ITEM	CHECK OR MAINTENANCE JOB	ODOMETER READING					ANNUAL CHECK
			1000 km (600 mi)	10000 km (6000 mi)	20000 km (12000 mi)	30000 km (18000 mi)	40000 km (24000 mi)	
9	* Swingarm	• Check operation and for excessive play.		√	√	√	√	
		• Lubricate with lithium-soap-based grease.	Every 50000 km (30000 mi)					
10	* Steering bearings	• Check bearing play and steering for roughness.	√	√	√	√	√	
		• Lubricate with lithium-soap-based grease.	Every 20000 km (12000 mi)					
11	* Chassis fasteners	• Make sure that all nuts, bolts and screws are properly tightened.		√	√	√	√	√
12	Brake lever pivot shaft	• Lubricate with silicone grease.		√	√	√	√	√
13	Brake pedal pivot shaft	• Lubricate with lithium-soap-based grease.		√	√	√	√	√
14	Clutch lever pivot shaft	• Lubricate with lithium-soap-based grease.		√	√	√	√	√
15	Shift pedal pivot shaft	• Lubricate with lithium-soap-based grease.		√	√	√	√	√
16	Sidestand	• Check operation. • Lubricate.		√	√	√	√	√
17	* Sidestand switch	• Check operation.	√	√	√	√	√	√
18	* Front fork	• Check operation and for oil leakage.		√	√	√	√	
19	* Shock absorber assembly	• Check operation and shock absorber for oil leakage.		√	√	√	√	

PERIODIC MAINTENANCE AND ADJUSTMENT

NO.	ITEM	CHECK OR MAINTENANCE JOB	ODOMETER READING					ANNUAL CHECK
			1000 km (600 mi)	10000 km (6000 mi)	20000 km (12000 mi)	30000 km (18000 mi)	40000 km (24000 mi)	
20	Engine oil	<ul style="list-style-type: none"> Change. Check oil level and vehicle for oil leakage. 	√	√	√	√	√	√
21	Engine oil filter element	<ul style="list-style-type: none"> Replace. 	√		√		√	
22	Final gear oil	<ul style="list-style-type: none"> Check oil level and vehicle for oil leakage. 	√	√		√		
		<ul style="list-style-type: none"> Change. 	√		√		√	
23 *	Front and rear brake switches	<ul style="list-style-type: none"> Check operation. 	√	√	√	√	√	√
24	Moving parts and cables	<ul style="list-style-type: none"> Lubricate. 		√	√	√	√	√
25 *	Throttle grip housing and cable	<ul style="list-style-type: none"> Check operation and free play. Adjust the throttle cable free play if necessary. Lubricate the throttle grip housing and cable. 		√	√	√	√	√
26 *	Lights, signals and switches	<ul style="list-style-type: none"> Check operation. Adjust headlight beam. 	√	√	√	√	√	√

EAU18660

TIP

- The air filter needs more frequent service if you are riding in unusually wet or dusty areas.
- Hydraulic brake service
 - Regularly check and, if necessary, correct the brake fluid level.
 - Every two years replace the internal components of the brake master cylinder and caliper, and change the brake fluid.

PERIODIC MAINTENANCE AND ADJUSTMENT

- Replace the brake hoses every four years and if cracked or damaged.
-

PERIODIC MAINTENANCE AND ADJUSTMENT

Removing and installing panels

EAU18771

The panels shown need to be removed to perform some of the maintenance jobs described in this chapter. Refer to this section each time a panel needs to be removed and installed.

XVS650Z

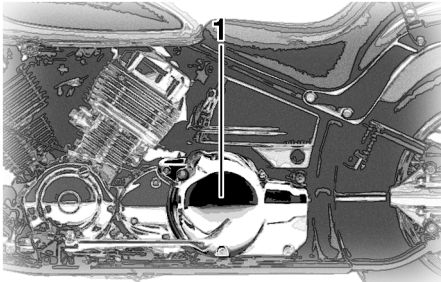

1. Panel A

XVS650AZ

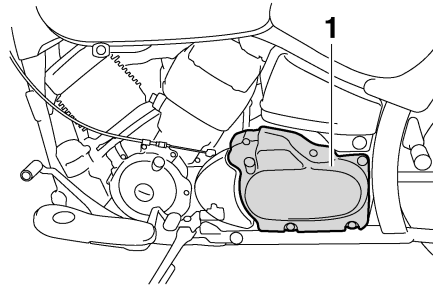

1. Panel A

XVS650Z/XVS650AZ

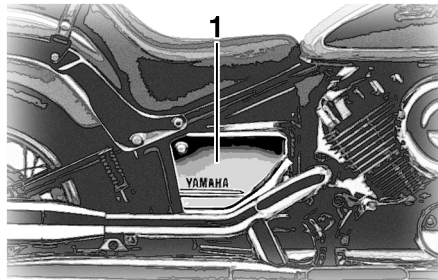

1. Panel B

XVS650Z

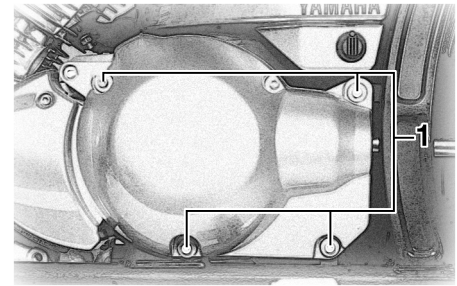

1. Bolt

XVS650AZ

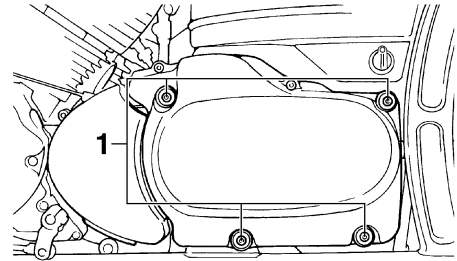

1. Bolt

Panel A

EAU19193

To remove the panel

Remove the bolts, and then take the panel off.

To install the panel

Place the panel in the original position, and then install the bolts.

PERIODIC MAINTENANCE AND ADJUSTMENT

Panel B

EAU19151

To remove the panel

Remove the bolt, and then pull the panel off as shown.

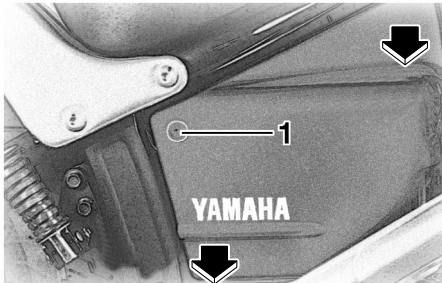

1. Bolt

To install the panel

Place the panel in the original position, and then install the bolt.

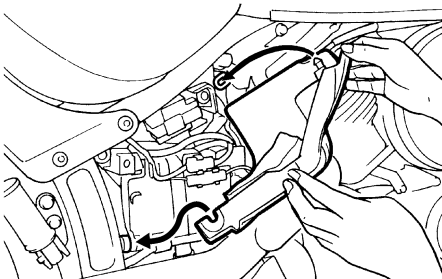

EAU19544

Checking the spark plugs

The spark plugs are important engine components, which are easy to check. Since heat and deposits will cause any spark plug to slowly erode, the spark plugs should be removed and checked in accordance with the periodic maintenance and lubrication chart. In addition, the condition of the spark plugs can reveal the condition of the engine.

To remove a spark plug

1. Remove the spark plug cap.

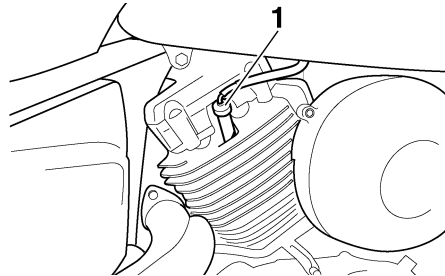

1. Spark plug cap

2. Remove the spark plug as shown, with the spark plug wrench included in the owner's tool kit.

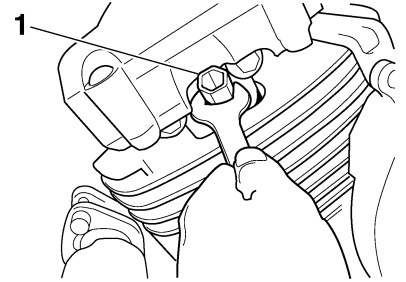

1. Spark plug wrench

To check the spark plugs

1. Check that the porcelain insulator around the center electrode on each spark plug is a medium-to-light tan (the ideal color when the vehicle is ridden normally).
2. Check that all spark plugs installed in the engine have the same color.

TIP

If any spark plug shows a distinctly different color, the engine could be operating improperly. Do not attempt to diagnose such problems yourself. Instead, have a Yamaha dealer check the vehicle.

PERIODIC MAINTENANCE AND ADJUSTMENT

EAU19744

3. Check each spark plug for electrode erosion and excessive carbon or other deposits, and replace it if necessary.

Specified spark plug:

NGK/DPR7EA-9
DENSO/X22EPR-U9

To install a spark plug

1. Measure the spark plug gap with a wire thickness gauge and, if necessary, adjust the gap to specification.

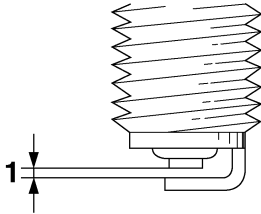

1. Spark plug gap

Spark plug gap:

0.8–0.9 mm (0.031–0.035 in)

2. Clean the surface of the spark plug gasket and its mating surface, and then wipe off any grime from the spark plug threads.
3. Install the spark plug with the spark plug wrench, and then tighten it to the specified torque.

Tightening torque:

Spark plug:
17.5 Nm (1.75 m·kgf, 12.7 ft·lbf)

TIP

If a torque wrench is not available when installing a spark plug, a good estimate of the correct torque is 1/4–1/2 turn past finger tight. However, the spark plug should be tightened to the specified torque as soon as possible.

4. Install the spark plug cap.

Engine oil and oil filter element

The engine oil level should be checked before each ride. In addition, the oil must be changed and the oil filter element replaced at the intervals specified in the periodic maintenance and lubrication chart.

To check the engine oil level

1. Place the vehicle on a level surface and hold it in an upright position. A slight tilt to the side can result in a false reading.
2. Start the engine, warm it up for several minutes, and then turn it off.
3. Wait a few minutes until the oil settles, and then check the oil level through the check window located at the bottom-left side of the crankcase.

TIP

The engine oil should be between the minimum and maximum level marks.

PERIODIC MAINTENANCE AND ADJUSTMENT

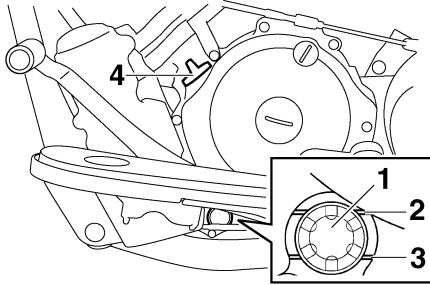

1. Engine oil level check window
2. Maximum level mark
3. Minimum level mark
4. Engine oil filler cap

4. If the engine oil is at or below the minimum level mark, add sufficient oil of the recommended type to raise it to the correct level.

To change the engine oil (with or without oil filter element replacement)

1. Start the engine, warm it up for several minutes, and then turn it off.
2. Place an oil pan under the engine to collect the used oil.

3. Remove the engine oil filler cap and drain bolt to drain the oil from the crankcase.

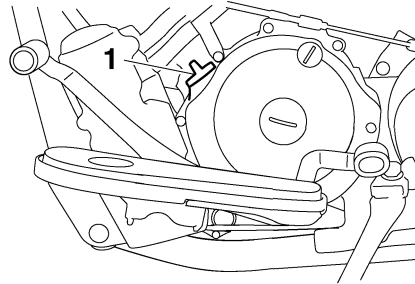

1. Engine oil filler cap

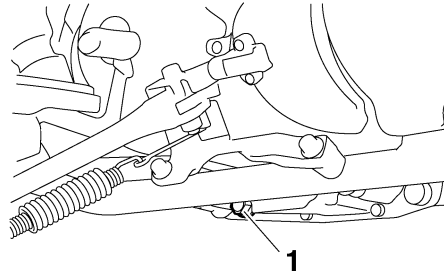

1. Engine oil drain bolt

TIP

Skip steps 4–7 if the oil filter element is not being replaced.

4. Remove the outer and inner oil filter element covers by removing the bolts.

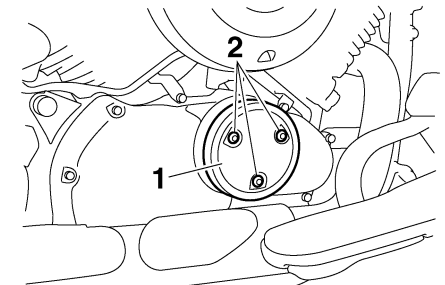

1. Outer oil filter element cover
2. Bolt

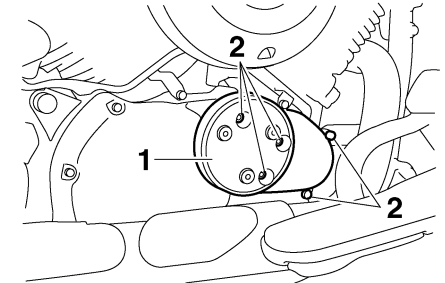

1. Inner oil filter element cover
2. Bolt

5. Remove the oil filter element and O-ring.

PERIODIC MAINTENANCE AND ADJUSTMENT

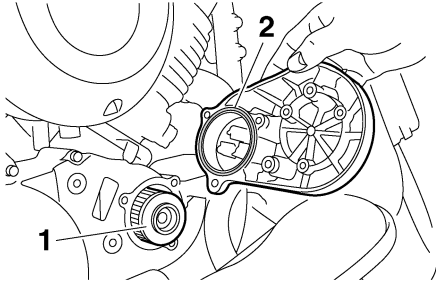

1. Oil filter element
2. O-ring

6. Install a new oil filter element and the O-ring.
7. Install the oil filter element covers by installing the bolts, and then tighten them to the specified torque.

Tightening torque:

Oil filter element cover bolt:
10 Nm (1.0 m·kgf, 7.2 ft·lbf)

8. Install the engine oil drain bolt, and then tighten it to the specified torque.

TIP

Check the washer for damage and replace it if necessary.

Tightening torque:

Engine oil drain bolt:
43 Nm (4.3 m·kgf, 31 ft·lbf)

9. Refill with the specified amount of the recommended oil, and then install and tighten the oil filler cap.

Recommended engine oil:

See page 9-1.

Oil quantity:

Without oil filter element replacement:

2.60 L (2.75 US qt, 2.29 Imp.qt)

With oil filter element replacement:

2.80 L (2.96 US qt, 2.46 Imp.qt)

TIP

Be sure to wipe off spilled oil on any parts after the engine and exhaust system have cooled down.

ECA11620

NOTICE

- In order to prevent clutch slippage (since the engine oil also lubricates the clutch), do not mix any chemical additives. Do not use oils with a diesel specification of “CD” or oils of a high-

er quality than specified. In addition, do not use oils labeled “ENERGY CONSERVING II” or higher.

- Make sure that no foreign material enters the crankcase.

10. Start the engine, and then let it idle for several minutes while checking it for oil leakage. If oil is leaking, immediately turn the engine off and check for the cause.
11. Turn the engine off, and then check the oil level and correct it if necessary.

PERIODIC MAINTENANCE AND ADJUSTMENT

Final gear oil

EAU20024

The final gear case must be checked for oil leakage before each ride. If any leakage is found, have a Yamaha dealer check and repair the vehicle. In addition, the final gear oil level must be checked and the oil changed as follows at the intervals specified in the periodic maintenance and lubrication chart.

EWA10370

WARNING

- Make sure that no foreign material enters the final gear case.
- Make sure that no oil gets on the tire or wheel.

To check the final gear oil level

1. Place the vehicle on a level surface and hold it in an upright position.

TIP

- The final gear oil level must be checked on a cold engine.
- Make sure that the vehicle is positioned straight up when checking the oil level. A slight tilt to the side can result in a false reading.

2. Remove the oil filler bolt, and then check the oil level in the final gear case.

TIP

The oil level should be at the brim of the filler hole.

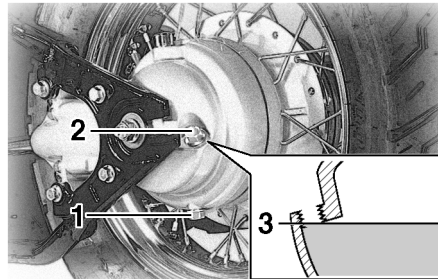

1. Final gear oil drain bolt
2. Final gear oil filler bolt
3. Correct oil level
3. If the oil is below the brim of the filler hole, add sufficient oil of the recommended type to raise it to the correct level.
4. Install the oil filler bolt, and then tighten it to the specified torque.

Tightening torque:

Final gear oil filler bolt:
23 Nm (2.3 m·kgf, 17 ft·lbf)

To change the final gear oil

1. Place an oil pan under the final gear case to collect the used oil.
2. Remove the oil filler bolt and drain bolt to drain the oil from the final gear case.
3. Install the final gear oil drain bolt, and then tighten it to the specified torque.

Tightening torque:

Final gear oil drain bolt:
23 Nm (2.3 m·kgf, 17 ft·lbf)

4. Refill with the recommended final gear oil to the brim of the filler hole.

Recommended final gear oil:

SAE80 API GL-4 Hypoid gear oil

Oil quantity:

0.19 L (0.20 US qt, 0.17 Imp.qt)

TIP

GL4 is a quality rating. Hypoid gear oils rated GL5 or GL6 may also be used.

PERIODIC MAINTENANCE AND ADJUSTMENT

5. Install the oil filler bolt, and then tighten it to the specified torque.

Tightening torque:

Final gear oil filler bolt:
23 Nm (2.3 m·kgf, 17 ft·lbf)

6. Check the final gear case for oil leakage. If oil is leaking, check for the cause.

EAU33383

Cleaning the air filter element

The air filter element should be cleaned at the intervals specified in the periodic maintenance and lubrication chart. Clean or, if necessary, replace the air filter element more frequently if you are riding in unusually wet or dusty areas.

1. Remove the air filter case cover by removing the bolts.

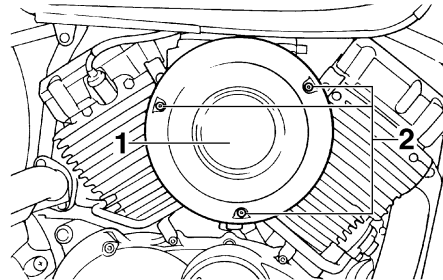

1. Air filter case cover
2. Bolt

2. Pull the air filter element out.
3. Lightly tap the air filter element to remove most of the dust and dirt, and then blow the remaining dirt out with compressed air as shown. If the air filter element is damaged, replace it.

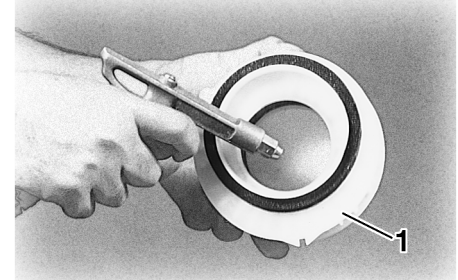

1. Air filter element

4. Insert the air filter element into the air filter case as shown. **NOTICE:** Make sure that the air filter element is properly seated in the air filter case. The engine should never be operated without the air filter element installed, otherwise the piston(s) and/or cylinder(s) may become excessively worn. [ECA10481]

PERIODIC MAINTENANCE AND ADJUSTMENT

EAU21290

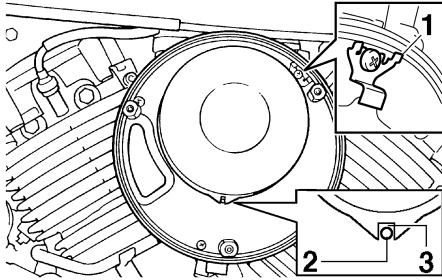

1. Air filter element holder
2. Projection
3. Slot

5. Install the air filter case cover by aligning the match marks and installing the bolts.

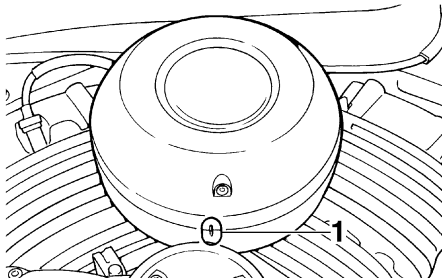

1. Match marks

TIP _____
If dust or water collects in the air filter check hose, remove the clamp from it, and then remove the plug to drain the hose.

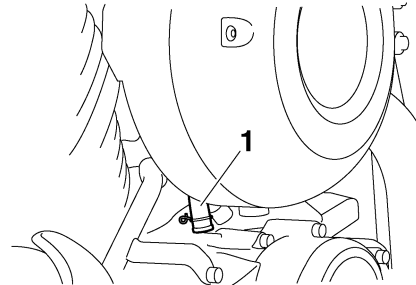

1. Air filter check hose

Adjusting the carburetors

The carburetors are important parts of the engine and require very sophisticated adjustment. Therefore, most carburetor adjustments should be left to a Yamaha dealer, who has the necessary professional knowledge and experience. The adjustment described in the following section, however, may be serviced by the owner as part of routine maintenance.

ECA10560

NOTICE _____

The carburetors have been set and extensively tested at the Yamaha factory. Changing these settings without sufficient technical knowledge may result in poor performance of or damage to the engine.

PERIODIC MAINTENANCE AND ADJUSTMENT

Adjusting the engine idling speed

EAU21340

The engine idling speed must be checked and, if necessary, adjusted as follows at the intervals specified in the periodic maintenance and lubrication chart.

The engine should be warm before making this adjustment.

TIP

- The engine is warm when it quickly responds to the throttle.
- A diagnostic tachometer is needed to make this adjustment.

1. Attach the tachometer to the spark plug lead.
2. Check the engine idling speed and, if necessary, adjust it to specification by turning the throttle stop screw. To increase the engine idling speed, turn the screw in direction (a). To decrease the engine idling speed, turn the screw in direction (b).

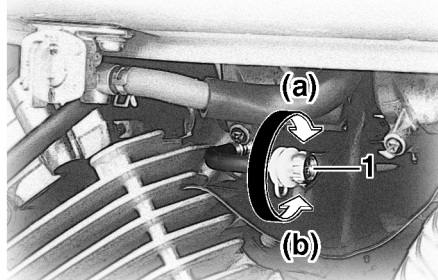

1. Throttle stop screw

Engine idling speed:
1150–1250 r/min

TIP

If the specified idling speed cannot be obtained as described above, have a Yamaha dealer make the adjustment.

Checking the throttle cable free play

EAU21382

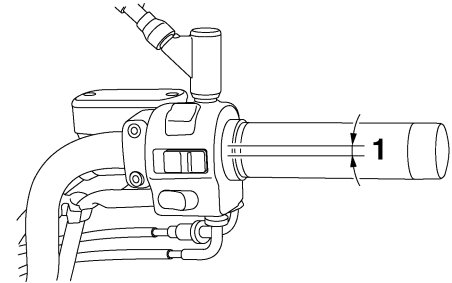

1. Throttle cable free play

The throttle cable free play should measure 4.0–6.0 mm (0.16–0.24 in) at the throttle grip. Periodically check the throttle cable free play and, if necessary, have a Yamaha dealer adjust it.

PERIODIC MAINTENANCE AND ADJUSTMENT

Valve clearance

EAU21401

The valve clearance changes with use, resulting in improper air-fuel mixture and/or engine noise. To prevent this from occurring, the valve clearance must be adjusted by a Yamaha dealer at the intervals specified in the periodic maintenance and lubrication chart.

Tires

EAU32773

To maximize the performance, durability, and safe operation of your motorcycle, note the following points regarding the specified tires.

Tire air pressure

The tire air pressure should be checked and, if necessary, adjusted before each ride.

EWA10501

WARNING

Operation of this vehicle with improper tire pressure may cause severe injury or death from loss of control.

- **The tire air pressure must be checked and adjusted on cold tires (i.e., when the temperature of the tires equals the ambient temperature).**
- **The tire air pressure must be adjusted in accordance with the riding speed and with the total weight of rider, passenger, cargo, and accessories approved for this model.**

Tire air pressure (measured on cold tires):

0–90 kg (0–198 lb):

Front:

XVS650AZ 225 kPa (2.25 kgf/cm², 33 psi)

XVS650Z 200 kPa (2.00 kgf/cm², 29 psi)

Rear:

225 kPa (2.25 kgf/cm², 33 psi)

XVS650AZ 90–200 kg (198–441 lb)

XVS650Z 90–180 kg (198–397 lb):

Front:

XVS650AZ 225 kPa (2.25 kgf/cm², 33 psi)

XVS650Z 200 kPa (2.00 kgf/cm², 29 psi)

Rear:

250 kPa (2.50 kgf/cm², 36 psi)

Maximum load*:

XVS650AZ 200 kg (441 lb)

XVS650Z 180 kg (397 lb)

* Total weight of rider, passenger, cargo and accessories

EWA10511

WARNING

Never overload your vehicle. Operation of an overloaded vehicle could cause an accident.

PERIODIC MAINTENANCE AND ADJUSTMENT

EWA10461

Tire inspection

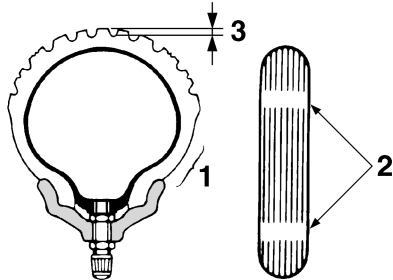

1. Tire sidewall
2. Tire wear indicator
3. Tire tread depth

Always check the tires before operating the motorcycle. If a tire tread shows crosswise lines (minimum tread depth), if the tire has a nail or glass fragments in it, or if the sidewall is cracked, contact a Yamaha dealer immediately and have the tire replaced.

Minimum tire tread depth (front and rear):

1.0 mm (0.04 in)

TIP

The tire tread depth limits may differ from country to country. Always comply with the local regulations.

EWA10561

WARNING

- It is dangerous to ride with a worn-out tire. When a tire tread begins to show crosswise lines, have a Yamaha dealer replace the tire immediately.
- The replacement of all wheel and brake-related parts, including the tires, should be left to a Yamaha dealer, who has the necessary professional knowledge and experience.
- It is not recommended to patch a punctured tube. If unavoidable, however, patch the tube very carefully and replace it as soon as possible with a high-quality product.

WARNING

The front and rear tires should be of the same make and design, otherwise the handling characteristics of the vehicle may be different, which could lead to an accident.

After extensive tests, only the tires listed below have been approved for this model by Yamaha Motor Co., Ltd.

Front tire:

Size:

XVS650AZ 130/90-16M/C 67S

XVS650Z 100/90-19M/C 57S

Manufacturer/model:

XVS650AZ DUNLOP/D404F

XVS650Z BRIDGESTONE/EXE-DRA L309

Rear tire:

Size:

170/80-15M/C 77S

Manufacturer/model:

XVS650AZ DUNLOP/D404G

XVS650Z BRIDGESTONE/EXE-DRA G546

Tire information

This motorcycle is equipped with spoke wheels and tube tires.

PERIODIC MAINTENANCE AND ADJUSTMENT

Spoke wheels

EAU21940

To maximize the performance, durability, and safe operation of your motorcycle, note the following points regarding the specified wheels.

- The wheel rims should be checked for cracks, bends or warpage, and the spokes for looseness or damage before each ride. If any damage is found, have a Yamaha dealer replace the wheel. Do not attempt even the smallest repair to the wheel. A deformed or cracked wheel must be replaced.
- The wheel should be balanced whenever either the tire or wheel has been changed or replaced. An unbalanced wheel can result in poor performance, adverse handling characteristics, and a shortened tire life.
- Ride at moderate speeds after changing a tire since the tire surface must first be “broken in” for it to develop its optimal characteristics.

Adjusting the clutch lever free play

EAU22043

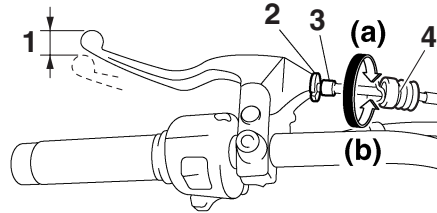

1. Clutch lever free play
2. Locknut (clutch lever)
3. Clutch lever free play adjusting bolt
4. Rubber cover

The clutch lever free play should measure XVS650AZ 5.0–10.0 mm (0.20–0.39 in)
XVS650Z 10.0–15.0 mm (0.39–0.59 in)
as shown. Periodically check the clutch lever free play and, if necessary, adjust it as follows.

1. Slide the rubber cover back at the clutch lever.
2. Loosen the locknut.

3. To increase the clutch lever free play, turn the adjusting bolt in direction (a). To decrease the clutch lever free play, turn the adjusting bolt in direction (b).

TIP

If the specified clutch lever free play could be obtained as described above, skip steps 4–7.

4. Fully turn the adjusting bolt at the clutch lever in direction (a) to loosen the clutch cable.
5. Loosen the locknut at the crankcase.

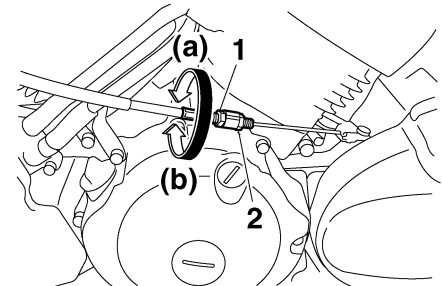

1. Clutch lever free play adjusting nut (crankcase)
2. Locknut (crankcase)

PERIODIC MAINTENANCE AND ADJUSTMENT

6. To increase the clutch lever free play, turn the adjusting nut in direction (a). To decrease the clutch lever free play, turn the adjusting nut in direction (b).
7. Tighten the locknut at the crankcase.
8. Tighten the locknut at the clutch lever and then slide the rubber cover to its original position.

Adjusting the brake lever free play

EAU22093

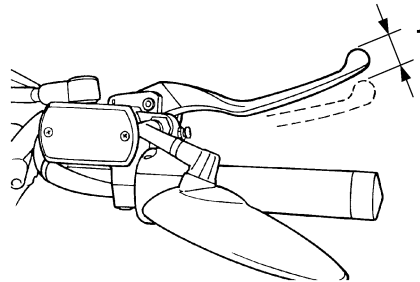

1. Brake lever free play

The brake lever free play should measure 10.0–15.0 mm (0.39–0.59 in) as shown. Periodically check the brake lever free play and, if necessary, adjust it as follows.

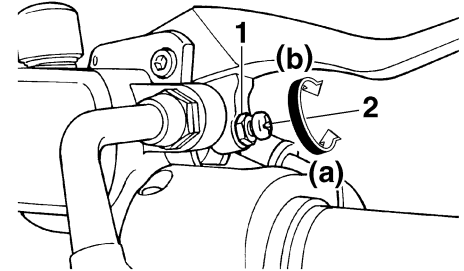

1. Locknut

2. Brake lever free play adjusting screw

1. Loosen the locknut at the brake lever.
2. To increase the brake lever free play, turn the brake lever free play adjusting screw in direction (a). To decrease the brake lever free play, turn the adjusting screw in direction (b).
3. Tighten the locknut.

EWA10630

WARNING

- After adjusting the brake lever free play, check the free play and make sure that the brake is working properly.

PERIODIC MAINTENANCE AND ADJUSTMENT

- A soft or spongy feeling in the brake lever can indicate the presence of air in the hydraulic system. If there is air in the hydraulic system, have a Yamaha dealer bleed the system before operating the motorcycle. Air in the hydraulic system will diminish the braking performance, which may result in loss of control and an accident.

Adjusting the brake pedal position and free play

EAU22231

XVS650Z

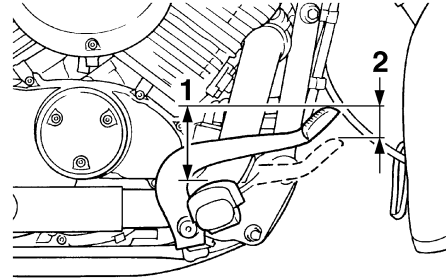

1. Distance between brake pedal and footrest
2. Brake pedal free play

XVS650AZ

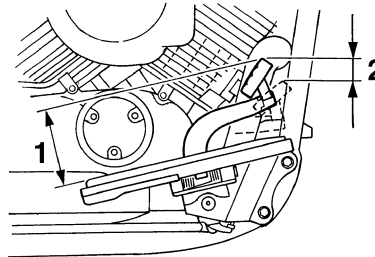

1. Distance between brake pedal and footrest
2. Brake pedal free play

WARNING

It is advisable to have a Yamaha dealer make these adjustments.

TIP

The brake pedal position should be adjusted before adjusting the brake pedal free play.

Brake pedal position

The brake pedal should be positioned approximately XVS650AZ 108.0 mm (4.25 in)

XVS650Z 82.0 mm (3.23 in) above the top of the footrest as shown. Periodically check the brake pedal position and, if necessary, adjust it as follows.

1. Loosen the locknut at the brake pedal.
2. To raise the brake pedal, turn the adjusting bolt in direction (a). To lower the brake pedal, turn the adjusting bolt in direction (b).

PERIODIC MAINTENANCE AND ADJUSTMENT

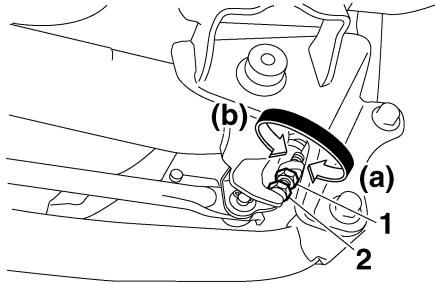

1. Locknut
 2. Brake pedal position adjusting bolt
3. Tighten the locknut.

EWA11230

WARNING

After adjusting the brake pedal position, the brake pedal free play must be adjusted.

Brake pedal free play

The brake pedal free play should measure 20.0–30.0 mm (0.79–1.18 in) at the brake pedal end. Periodically check the brake pedal free play and, if necessary, adjust it as follows.

To increase the brake pedal free play, turn the adjusting nut at the brake rod in direction (a). To decrease the brake pedal free play, turn the adjusting nut in direction (b).

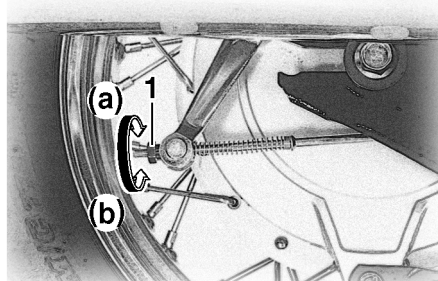

1. Brake pedal free play adjusting nut

Adjusting the rear brake light switch

EAU22272

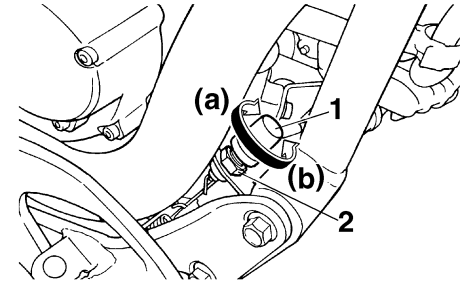

1. Rear brake light switch
2. Rear brake light switch adjusting nut

The rear brake light, which is activated by the brake pedal, should come on just before braking takes effect. If necessary, adjust the rear brake light switch as follows.

Turn the rear brake light switch adjusting nut while holding the rear brake light switch in place. To make the brake light come on earlier, turn the adjusting nut in direction (a). To make the brake light come on later, turn the adjusting nut in direction (b).

PERIODIC MAINTENANCE AND ADJUSTMENT

Checking the front brake pads and rear brake shoes

EAU22380

The front brake pads and the rear brake shoes must be checked for wear at the intervals specified in the periodic maintenance and lubrication chart.

Front brake pads

EAU22430

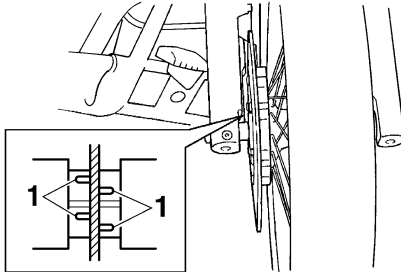

1. Brake pad wear indicator groove

Each front brake pad is provided with wear indicator grooves, which allow you to check the brake pad wear without having to disassemble the brake. To check the brake pad wear, check the wear indicator grooves. If a brake pad has worn to the point that the wear

indicator grooves have almost disappeared, have a Yamaha dealer replace the brake pads as a set.

Rear brake shoes

EAU22540

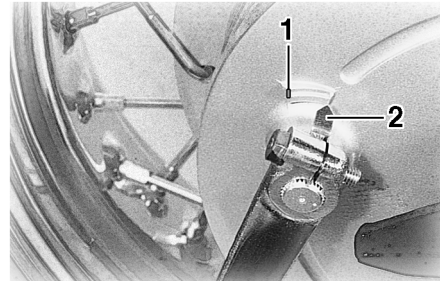

1. Brake shoe wear limit line
2. Brake shoe wear indicator

The rear brake is provided with a wear indicator, which allows you to check the brake shoe wear without having to disassemble the brake. To check the brake shoe wear, check the position of the wear indicator while applying the brake. If a brake shoe has worn to the point that the wear indicator reaches the wear limit line, have a Yamaha dealer replace the brake shoes as a set.

Checking the brake fluid level

EAU32344

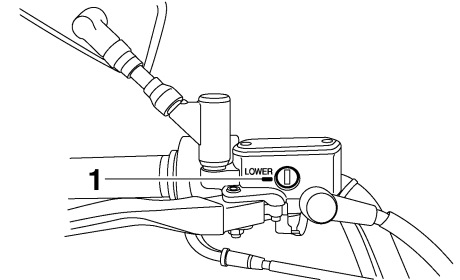

1. Minimum level mark

Insufficient brake fluid may allow air to enter the brake system, possibly causing it to become ineffective.

Before riding, check that the brake fluid is above the minimum level mark and replenish if necessary. A low brake fluid level may indicate worn brake pads and/or brake system leakage. If the brake fluid level is low, be sure to check the brake pads for wear and the brake system for leakage.

Observe these precautions:

- When checking the fluid level, make sure that the top of the master cylinder is level by turning the handlebars.

PERIODIC MAINTENANCE AND ADJUSTMENT

- Use only the recommended quality brake fluid, otherwise the rubber seals may deteriorate, causing leakage and poor braking performance.

Recommended brake fluid:
DOT 4

- Refill with the same type of brake fluid. Mixing fluids may result in a harmful chemical reaction and lead to poor braking performance.
- Be careful that water does not enter the master cylinder when refilling. Water will significantly lower the boiling point of the fluid and may result in vapor lock.
- Brake fluid may deteriorate painted surfaces or plastic parts. Always clean up spilled fluid immediately.
- As the brake pads wear, it is normal for the brake fluid level to gradually go down. However, if the brake fluid level goes down suddenly, have a Yamaha dealer check the cause.

Changing the brake fluid

EAU22721

Have a Yamaha dealer change the brake fluid at the intervals specified in the TIP after the periodic maintenance and lubrication chart. In addition, have the oil seals of the brake master cylinder and caliper as well as the brake hose replaced at the intervals listed below or whenever they are damaged or leaking.

- Oil seals: Replace every two years.
- Brake hose: Replace every four years.

Checking and lubricating the cables

EAU23101

The operation of all control cables and the condition of the cables should be checked before each ride, and the cables and cable ends should be lubricated if necessary. If a cable is damaged or does not move smoothly, have a Yamaha dealer check or replace it. **WARNING! Damage to the outer sheath may interfere with proper cable operation and will cause the inner cable to rust. Replace a damaged cable as soon as possible to prevent unsafe conditions.** [EWA10721]

Recommended lubricant:
Engine oil

PERIODIC MAINTENANCE AND ADJUSTMENT

Checking and lubricating the throttle grip and cable

EAU23111

The operation of the throttle grip should be checked before each ride. In addition, the cable should be lubricated at the intervals specified in the periodic maintenance chart.

Checking and lubricating the brake and shift pedals

EAU44271

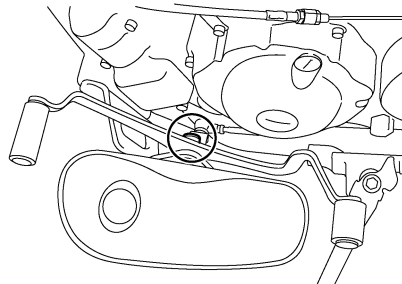
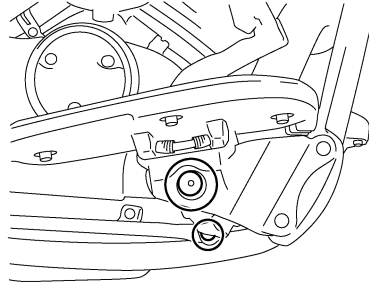

Recommended lubricant:
Lithium-soap-based grease

The operation of the brake and shift pedals should be checked before each ride, and the pedal pivots should be lubricated if necessary.

PERIODIC MAINTENANCE AND ADJUSTMENT

Checking and lubricating the brake and clutch levers

EAU23142

Brake lever

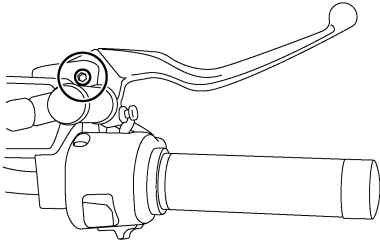

Clutch lever

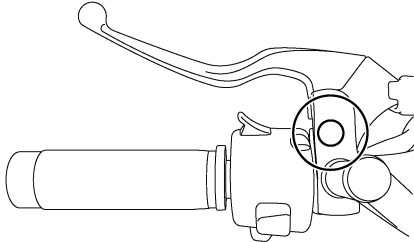

The operation of the brake and clutch levers should be checked before each ride, and the lever pivots should be lubricated if necessary.

Recommended lubricants:

- Brake lever:
Silicone grease
- Clutch lever:
Lithium-soap-based grease

Checking and lubricating the sidestand

EAU23202

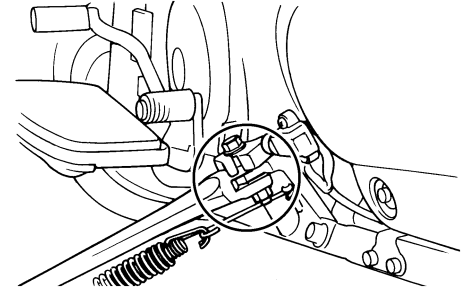

The operation of the sidestand should be checked before each ride, and the sidestand pivot and metal-to-metal contact surfaces should be lubricated if necessary.

EWA10731

⚠ WARNING

If the sidestand does not move up and down smoothly, have a Yamaha dealer check or repair it. Otherwise, the sidestand could contact the ground and distract the operator, resulting in a possible loss of control.

Recommended lubricant:

- Lithium-soap-based grease

PERIODIC MAINTENANCE AND ADJUSTMENT

EAUM1650

Lubricating the swingarm pivots

The swingarm pivots must be lubricated at the intervals specified in the periodic maintenance and lubrication chart.

Recommended lubricant:
Lithium-soap-based grease

EAU23272

Checking the front fork

The condition and operation of the front fork must be checked as follows at the intervals specified in the periodic maintenance and lubrication chart.

To check the condition

Check the inner tubes for scratches, damage and excessive oil leakage.

To check the operation

1. Place the vehicle on a level surface and hold it in an upright position. **WARNING! To avoid injury, securely support the vehicle so there is no danger of it falling over.** [EWA10751]
2. While applying the front brake, push down hard on the handlebars several times to check if the front fork compresses and rebounds smoothly.

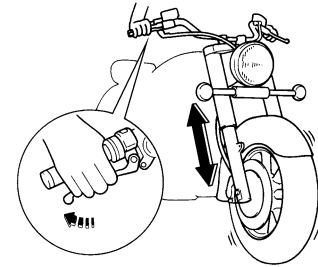

ECA10590

NOTICE

If any damage is found or the front fork does not operate smoothly, have a Yamaha dealer check or repair it.

PERIODIC MAINTENANCE AND ADJUSTMENT

EAU23283

Checking the steering

Worn or loose steering bearings may cause danger. Therefore, the operation of the steering must be checked as follows at the intervals specified in the periodic maintenance and lubrication chart.

1. Place a stand under the engine to raise the front wheel off the ground. (See page 7-32 for more information.) **WARNING! To avoid injury, securely support the vehicle so there is no danger of it falling over.** [EWA10751]
2. Hold the lower ends of the front fork legs and try to move them forward and backward. If any free play can be felt, have a Yamaha dealer check or repair the steering.

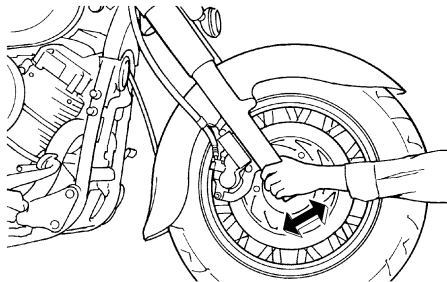

EAU23290

Checking the wheel bearings

The front and rear wheel bearings must be checked at the intervals specified in the periodic maintenance and lubrication chart. If there is play in the wheel hub or if the wheel does not turn smoothly, have a Yamaha dealer check the wheel bearings.

EAU23385

Battery

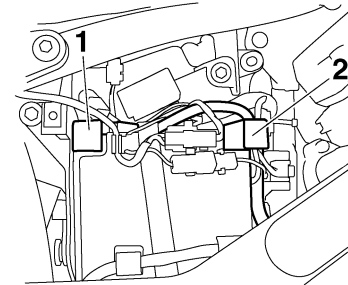

1. Positive battery lead (red)
2. Negative battery lead (black)

The battery is located behind panel B. (See page 7-7.)

This model is equipped with a VRLA (Valve Regulated Lead Acid) battery. There is no need to check the electrolyte or to add distilled water. However, the battery lead connections need to be checked and, if necessary, tightened.

ECA10620

NOTICE

Never attempt to remove the battery cell seals, as this would permanently damage the battery.

PERIODIC MAINTENANCE AND ADJUSTMENT

EWA10760

WARNING

- Electrolyte is poisonous and dangerous since it contains sulfuric acid, which causes severe burns. Avoid any contact with skin, eyes or clothing and always shield your eyes when working near batteries. In case of contact, administer the following **FIRST AID**.
 - **EXTERNAL:** Flush with plenty of water.
 - **INTERNAL:** Drink large quantities of water or milk and immediately call a physician.
 - **EYES:** Flush with water for 15 minutes and seek prompt medical attention.
- Batteries produce explosive hydrogen gas. Therefore, keep sparks, flames, cigarettes, etc., away from the battery and provide sufficient ventilation when charging it in an enclosed space.

- **KEEP THIS AND ALL BATTERIES OUT OF THE REACH OF CHILDREN.**

To charge the battery

Have a Yamaha dealer charge the battery as soon as possible if it seems to have discharged. Keep in mind that the battery tends to discharge more quickly if the vehicle is equipped with optional electrical accessories.

ECA16520

NOTICE

To charge a VRLA (Valve Regulated Lead Acid) battery, a special (constant-voltage) battery charger is required. Using a conventional battery charger will damage the battery. If you do not have access to a constant-voltage battery charger, have a Yamaha dealer charge your battery.

To store the battery

1. If the vehicle will not be used for more than one month, remove the battery, fully charge it, and then place it in a cool, dry place.
NOTICE: When removing the

battery, be sure the key is turned to “OFF”, then disconnect the negative lead before disconnecting the positive lead.

[ECA16302]

2. If the battery will be stored for more than two months, check it at least once a month and fully charge it if necessary.
3. Fully charge the battery before installation.
4. After installation, make sure that the battery leads are properly connected to the battery terminals.

ECA16530

NOTICE

Always keep the battery charged. Storing a discharged battery can cause permanent battery damage.

PERIODIC MAINTENANCE AND ADJUSTMENT

EAU23526

Replacing the fuses

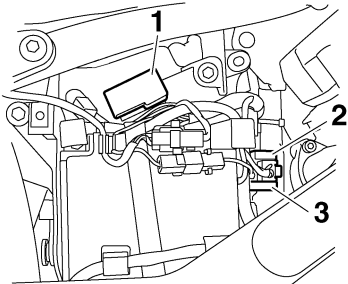

1. Fuse box
2. Main fuse
3. Spare main fuse

The main fuse and the fuse box, which contains the fuses for the individual circuits, are located behind panel B. (See page 7-7.)

If a fuse is blown, replace it as follows.

1. Turn the key to "OFF" and turn off the electrical circuit in question.
2. Remove the blown fuse, and then install a new fuse of the specified amperage. **WARNING! Do not use a fuse of a higher amperage rating than recommended to**

avoid causing extensive damage to the electrical system and possibly a fire. [EWA15131]

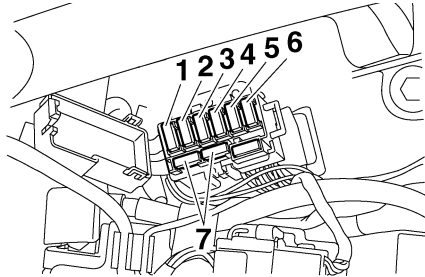

1. Headlight fuse
2. Signaling system fuse
3. Ignition fuse
4. Carburetor heater fuse
5. Parking lighting fuse (XVS650AZ)
6. Backup fuse (for odometer and immobilizer system) (XVS650AZ)
7. Spare fuse

Specified fuses:

- Main fuse:
30.0 A
- Signaling system fuse:
10.0 A
- Ignition fuse:
10.0 A
- Headlight fuse:
15.0 A
- Carburetor heater fuse:
15.0 A
- Backup fuse:
XVS650AZ 10.0 A
- Parking lighting fuse:
XVS650AZ 10.0 A

3. Turn the key to "ON" and turn on the electrical circuit in question to check if the device operates.
4. If the fuse immediately blows again, have a Yamaha dealer check the electrical system.

PERIODIC MAINTENANCE AND ADJUSTMENT

Replacing the headlight bulb

EAU23795

This model is equipped with a quartz bulb headlight. If the headlight bulb burns out, replace it as follows.

ECA10650

NOTICE

Take care not to damage the following parts:

- **Headlight bulb**

Do not touch the glass part of the headlight bulb to keep it free from oil, otherwise the transparency of the glass, the luminosity of the bulb, and the bulb life will be adversely affected. Thoroughly clean off any dirt and fingerprints on the headlight bulb using a cloth moistened with alcohol or thinner.

- **Headlight lens**

Do not affix any type of tinted film or stickers to the headlight lens.

Do not use a headlight bulb of a wattage higher than specified.

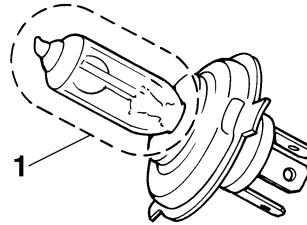

1. Do not touch the glass part of the bulb.

1. Remove the headlight unit by removing the screws.

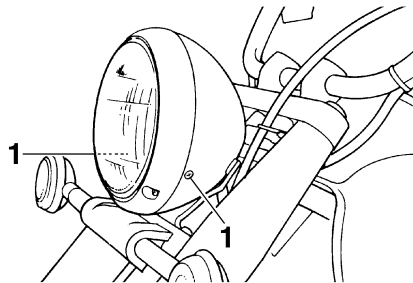

1. Screw

2. Disconnect the headlight coupler, and then remove the bulb cover.

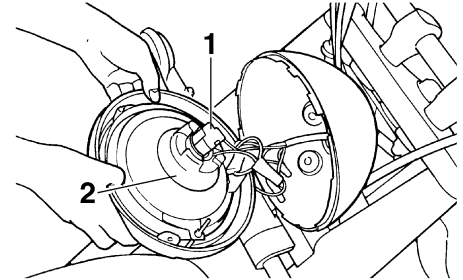

1. Headlight coupler
2. Headlight bulb cover

3. Unhook the headlight bulb holder, and then remove the burnt-out bulb.

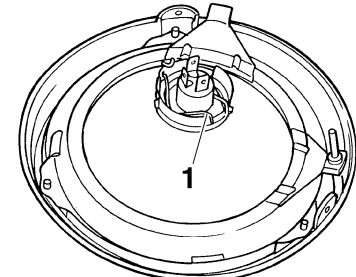

1. Headlight bulb holder

4. Place a new headlight bulb into position, and then secure it with the bulb holder.

PERIODIC MAINTENANCE AND ADJUSTMENT

5. Install the headlight bulb cover, and then connect the coupler.
6. Install the headlight unit by installing the screws.
7. Have a Yamaha dealer adjust the headlight beam if necessary.

Replacing a turn signal light bulb or the tail/brake light bulb

EAU24283

1. Remove the lens by removing the screws.

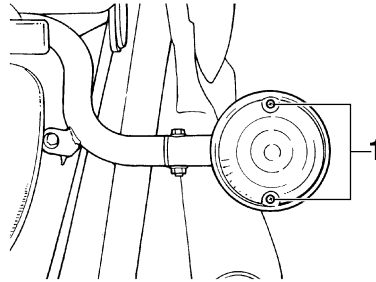

1. Screw

XVS650Z

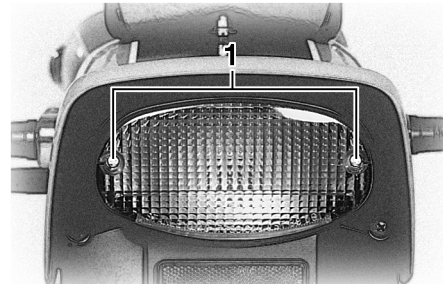

1. Screw

XVS650AZ

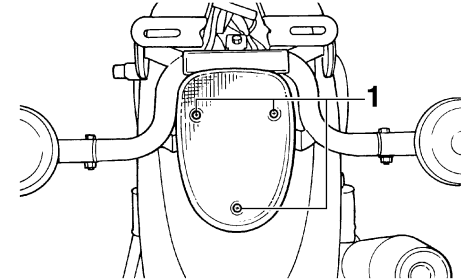

1. Screw

2. Remove the burnt-out bulb by pushing it in and turning it counter-clockwise.
3. Insert a new bulb into the socket, push it in, and then turn it clockwise until it stops.
4. Install the lens by installing the screws. **NOTICE: Do not over-tighten the screws, otherwise the lens may break.** [ECA10681]

EAU33413

Replacing the auxiliary light bulb (XVS650AZ)

If the auxiliary light bulb burns out, replace it as follows.

1. Remove the headlight unit by removing the screws.

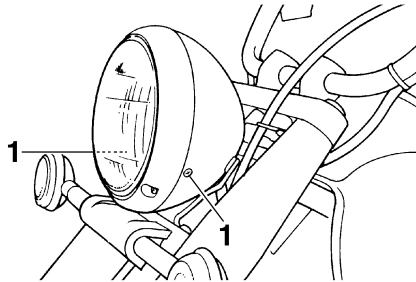

1. Screw

2. Remove the socket (together with the bulb) by pushing it in and turning it counterclockwise.

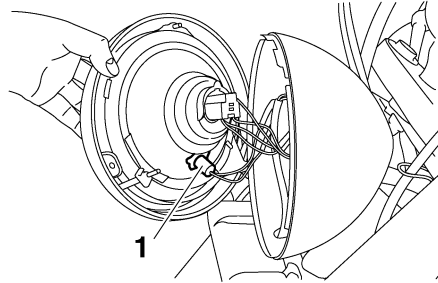

1. Auxiliary light bulb socket

3. Remove the burnt-out bulb by pushing it in and turning it counterclockwise.
4. Insert a new bulb into the socket, push it in, and then turn it clockwise until it stops.
5. Install the socket (together with the bulb) by pushing it in and turning it clockwise until it stops.
6. Install the headlight unit by installing the screws.

EAU24350

Supporting the motorcycle

Since this model is not equipped with a centerstand, follow these precautions when removing the front and rear wheel or performing other maintenance requiring the motorcycle to stand upright. Check that the motorcycle is in a stable and level position before starting any maintenance. A strong wooden box can be placed under the engine for added stability.

To service the front wheel

1. Stabilize the rear of the motorcycle by using a motorcycle stand or, if an additional motorcycle stand is not available, by placing a jack under the frame in front of the rear wheel.
2. Raise the front wheel off the ground by using a motorcycle stand.

To service the rear wheel

Raise the rear wheel off the ground by using a motorcycle stand or, if a motorcycle stand is not available, by placing

PERIODIC MAINTENANCE AND ADJUSTMENT

a jack either under each side of the frame in front of the rear wheel or under each side of the swingarm.

Front wheel

EAU24360

To remove the front wheel

EAU24601

EWA10821



WARNING

To avoid injury, securely support the vehicle so there is no danger of it falling over.

1. Disconnect the speedometer cable from the front wheel.

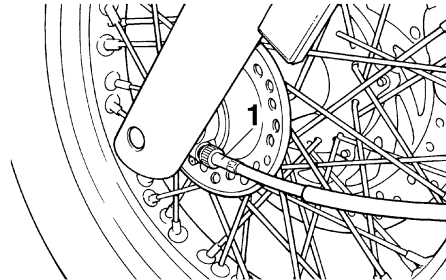

1. Speedometer cable

2. Loosen the front wheel axle pinch bolt, then the wheel axle.

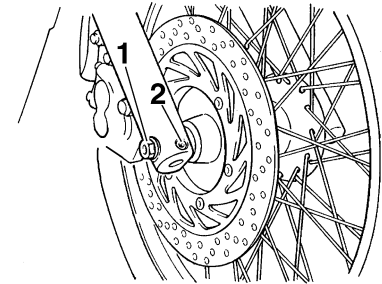

1. Wheel axle
2. Front wheel axle pinch bolt

3. Lift the front wheel off the ground according to the procedure on page 7-32.
4. Pull the wheel axle out, and then remove the wheel. **NOTICE: Do not apply the brake after the wheel has been removed together with the brake disc, otherwise the brake pads will be forced shut.** [ECA11071]

To install the front wheel

EAU24933

1. Install the speedometer gear unit into the wheel hub so that the projections mesh with the slots.

PERIODIC MAINTENANCE AND ADJUSTMENT

2. Lift the wheel up between the fork legs.

TIP _____

Make sure that there is enough space between the brake pads before inserting the brake disc and that the slot in the speedometer gear unit fits over the retainer on the fork leg.

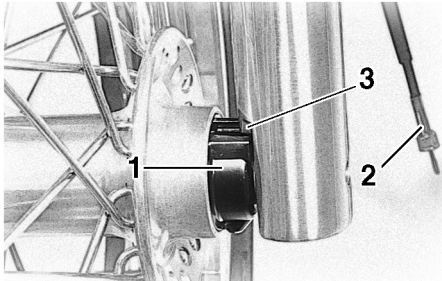

1. Speedometer gear unit
2. Speedometer cable
3. Retainer

3. Insert the wheel axle.
4. Lower the front wheel so that it is on the ground, and then put the sidestand down.
5. Tighten the wheel axle to the specified torque.

Tightening torque:

Wheel axle:
59 Nm (5.9 m·kgf, 43 ft·lbf)

6. Tighten the front wheel axle pinch bolt to the specified torque.

Tightening torque:

Front wheel axle pinch bolt:
20 Nm (2.0 m·kgf, 14 ft·lbf)

7. While applying the front brake, push down hard on the handlebars several times to check if the front fork compresses and rebounds smoothly.
8. Connect the speedometer cable.

Rear wheel

EAU25080

EAU25142

EWA10821

To remove the rear wheel



To avoid injury, securely support the vehicle so there is no danger of it falling over.

1. Loosen the axle nut.

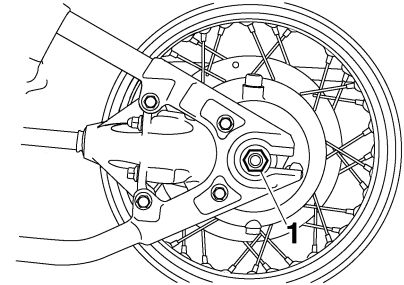

1. Axle nut
2. Disconnect the brake torque rod from the brake shoe plate by removing the bolt and nut.
3. Loosen the brake torque rod nut at the swingarm.

PERIODIC MAINTENANCE AND ADJUSTMENT

4. Remove the brake pedal free play adjusting nut, and then disconnect the brake rod from the brake camshaft lever.

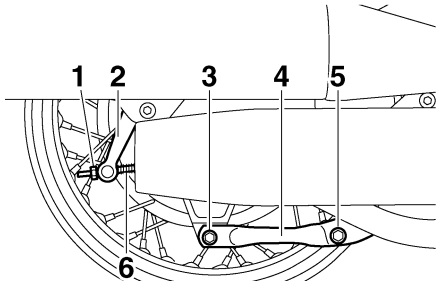

1. Brake pedal free play adjusting nut
2. Brake camshaft lever
3. Bolt and nut (shoe plate)
4. Brake torque rod
5. Bolt and nut (swingarm)
6. Brake rod

5. Remove panel A. (See page 7-7.)
6. Remove the bolts that secure the final gear case to the swingarm.

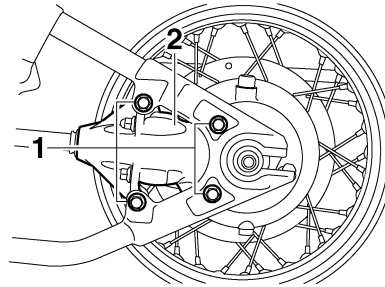

1. Bolt
2. Final gear case

7. Lift the rear wheel off the ground according to the procedure on page 7-32.
8. While supporting the drive shaft, pull the rear wheel back to remove the following parts as an assembly: wheel, wheel axle, final gear case, and drive shaft.

TIP

Make sure to support the drive shaft as it is being pulled out.

To install the rear wheel

EAU25512

1. Install the rear wheel, wheel axle, final gear case, and drive shaft by pushing the wheel forward and guiding the drive shaft into the middle gear universal joint.

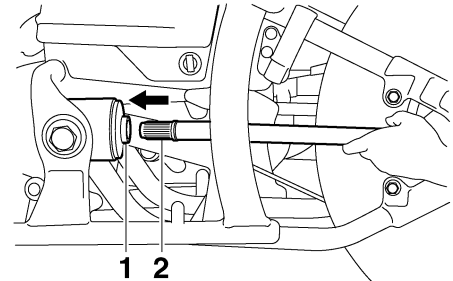

1. Middle gear universal joint
2. Drive shaft

2. Install the final gear case bolts.
3. Install the brake rod onto the brake camshaft lever, and then install the brake pedal free play adjusting nut onto the brake rod.
4. Install the brake torque rod bolt and nut at the brake shoe plate.
5. Install the panel.

PERIODIC MAINTENANCE AND ADJUSTMENT

6. Lower the rear wheel so that it is on the ground, and then put the sidestand down.
7. Tighten the axle nut, the final gear case bolts and the brake torque rod nuts to the specified torques.

Tightening torques:

Axle nut:

92 Nm (9.2 m·kgf, 66 ft·lbf)

Final gear case bolt:

74 Nm (7.4 m·kgf, 53 ft·lbf)

Brake torque rod nut:

20 Nm (2.0 m·kgf, 14 ft·lbf)

8. Adjust the brake pedal free play. (See page 7-20.)

EWA10660

WARNING

After adjusting the brake pedal free play, check the operation of the brake light.

Troubleshooting

EAU25851

Although Yamaha motorcycles receive a thorough inspection before shipment from the factory, trouble may occur during operation. Any problem in the fuel, compression, or ignition systems, for example, can cause poor starting and loss of power.

The following troubleshooting chart represents a quick and easy procedure for checking these vital systems yourself. However, should your motorcycle require any repair, take it to a Yamaha dealer, whose skilled technicians have the necessary tools, experience, and know-how to service the motorcycle properly.

Use only genuine Yamaha replacement parts. Imitation parts may look like Yamaha parts, but they are often inferior, have a shorter service life and can lead to expensive repair bills.

EWA15141

WARNING

When checking the fuel system, do not smoke, and make sure there are no open flames or sparks in the area, including pilot lights from water

heaters or furnaces. Gasoline or gasoline vapors can ignite or explode, causing severe injury or property damage.

PERIODIC MAINTENANCE AND ADJUSTMENT

EAU25892

Troubleshooting chart

1. Fuel

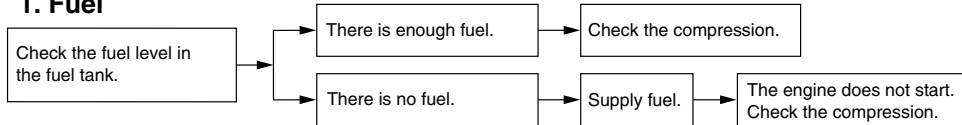

2. Compression

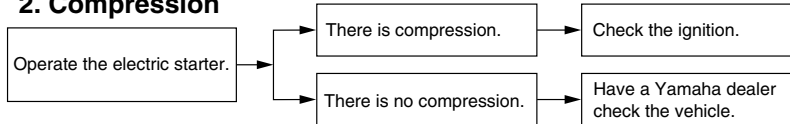

3. Ignition

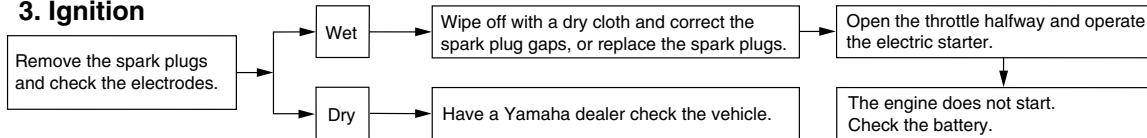

4. Battery

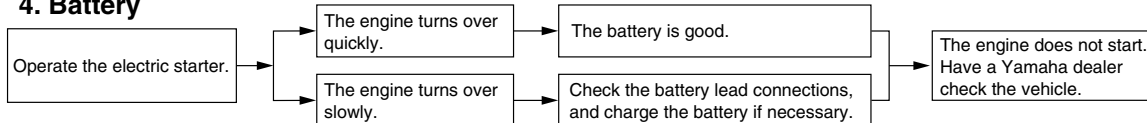

Matte color caution

EAU37833

EAU26063

NOTICE

Some models are equipped with matte colored finished parts. Be sure to consult a Yamaha dealer for advice on what products to use before cleaning the vehicle. Using a brush, harsh chemical products or cleaning compounds when cleaning these parts will scratch or damage their surface. Wax also should not be applied to any matte colored finished parts.

ECA15192

Care

While the open design of a motorcycle reveals the attractiveness of the technology, it also makes it more vulnerable. Rust and corrosion can develop even if high-quality components are used. A rusty exhaust pipe may go unnoticed on a car, however, it detracts from the overall appearance of a motorcycle. Frequent and proper care does not only comply with the terms of the warranty, but it will also keep your motorcycle looking good, extend its life and optimize its performance.

Before cleaning

1. Cover the muffler outlets with plastic bags after the engine has cooled down.
2. Make sure that all caps and covers as well as all electrical couplers and connectors, including the spark plug caps, are tightly installed.
3. Remove extremely stubborn dirt, like oil burnt onto the crankcase, with a degreasing agent and a brush, but never apply such prod-

ucts onto seals, gaskets and wheel axles. Always rinse the dirt and degreaser off with water.

Cleaning

ECA10772

NOTICE

- Avoid using strong acidic wheel cleaners, especially on spoked wheels. If such products are used on hard-to-remove dirt, do not leave the cleaner on the affected area any longer than instructed. Also, thoroughly rinse the area off with water, immediately dry it, and then apply a corrosion protection spray.
- Improper cleaning can damage plastic parts (such as cowlings, panels, windshields, headlight lenses, meter lenses, etc.) and the mufflers. Use only a soft, clean cloth or sponge with water to clean plastic. However, if the plastic parts cannot be thoroughly cleaned with water, diluted mild detergent with water may be used. Be sure to rinse

MOTORCYCLE CARE AND STORAGE

off any detergent residue using plenty of water, as it is harmful to plastic parts.

- Do not use any harsh chemical products on plastic parts. Be sure to avoid using cloths or sponges which have been in contact with strong or abrasive cleaning products, solvent or thinner, fuel (gasoline), rust removers or inhibitors, brake fluid, antifreeze or electrolyte.
- Do not use high-pressure washers or steam-jet cleaners since they cause water seepage and deterioration in the following areas: seals (of wheel and swing-arm bearings, fork and brakes), electric components (couplers, connectors, instruments, switches and lights), breather hoses and vents.
- For motorcycles equipped with a windshield: Do not use strong cleaners or hard sponges as they will cause dulling or scratching. Some cleaning compounds for plastic may leave scratches on the windshield.

Test the product on a small hidden part of the windshield to make sure that it does not leave any marks. If the windshield is scratched, use a quality plastic polishing compound after washing.

After normal use

Remove dirt with warm water, a mild detergent, and a soft, clean sponge, and then rinse thoroughly with clean water. Use a toothbrush or bottlebrush for hard-to-reach areas. Stubborn dirt and insects will come off more easily if the area is covered with a wet cloth for a few minutes before cleaning.

After riding in the rain, near the sea or on salt-sprayed roads

Since sea salt or salt sprayed on roads during winter are extremely corrosive in combination with water, carry out the following steps after each ride in the rain, near the sea or on salt-sprayed roads.

TIP

Salt sprayed on roads in the winter may remain well into spring.

1. Clean the motorcycle with cold water and a mild detergent, after the engine has cooled down.
NOTICE: Do not use warm water since it increases the corrosive action of the salt.^[ECA10791]
2. After drying the motorcycle, apply a corrosion protection spray on all metal, including chrome- and nickel-plated, surfaces to prevent corrosion.

After cleaning

1. Dry the motorcycle with a chamois or an absorbing cloth.
2. Use a chrome polish to shine chrome, aluminum and stainless-steel parts, including the exhaust system. (Even the thermally induced discoloring of stainless-steel exhaust systems can be removed through polishing.)

3. To prevent corrosion, it is recommended to apply a corrosion protection spray on all metal, including chrome- and nickel-plated, surfaces.
4. Use spray oil as a universal cleaner to remove any remaining dirt.
5. Touch up minor paint damage caused by stones, etc.
6. Wax all painted surfaces.
7. Let the motorcycle dry completely before storing or covering it.

EWA11131

WARNING

Contaminants on the brakes or tires can cause loss of control.

- **Make sure that there is no oil or wax on the brakes or tires.**
- **If necessary, clean the brake discs and brake linings with a regular brake disc cleaner or acetone, and wash the tires with warm water and a mild detergent. Before riding at higher speeds, test the motorcycle's braking performance and cornering behavior.**

ECA10800

NOTICE

- **Apply spray oil and wax sparingly and make sure to wipe off any excess.**
- **Never apply oil or wax to any rubber and plastic parts, but treat them with a suitable care product.**
- **Avoid using abrasive polishing compounds as they will wear away the paint.**

TIP

- Consult a Yamaha dealer for advice on what products to use.
- Washing, rainy weather or humid climates can cause the headlight lens to fog. Turning the headlight on for a short period of time will help remove the moisture from the lens.

EAU26231

Storage

Short-term

Always store your motorcycle in a cool, dry place and, if necessary, protect it against dust with a porous cover.

ECA10810

NOTICE

- **Storing the motorcycle in a poorly ventilated room or covering it with a tarp, while it is still wet, will allow water and humidity to seep in and cause rust.**
- **To prevent corrosion, avoid damp cellars, stables (because of the presence of ammonia) and areas where strong chemicals are stored.**

Long-term

Before storing your motorcycle for several months:

1. Follow all the instructions in the "Care" section of this chapter.
2. For motorcycles equipped with a fuel cock that has an "OFF" position: Turn the fuel cock lever to "OFF".

MOTORCYCLE CARE AND STORAGE

3. Drain the carburetor float chambers by loosening the drain bolts; this will prevent fuel deposits from building up. Pour the drained fuel into the fuel tank.
4. Fill up the fuel tank and add fuel stabilizer (if available) to prevent the fuel tank from rusting and the fuel from deteriorating.
5. Perform the following steps to protect the cylinders, piston rings, etc. from corrosion.
 - a. Remove the spark plug caps and spark plugs.
 - b. Pour a teaspoonful of engine oil into each spark plug bore.
 - c. Install the spark plug caps onto the spark plugs, and then place the spark plugs on the cylinder head so that the electrodes are grounded. (This will limit sparking during the next step.)
 - d. Turn the engine over several times with the starter. (This will coat the cylinder walls with oil.)**WARNING! To prevent damage or injury from sparking, make sure to ground the**

spark plug electrodes while turning the engine over.

[EWA10951]

- e. Remove the spark plug caps from the spark plugs, and then install the spark plugs and the spark plug caps.
6. Lubricate all control cables and the pivoting points of all levers and pedals as well as of the side-stand/centerstand.
7. Check and, if necessary, correct the tire air pressure, and then lift the motorcycle so that both of its wheels are off the ground. Alternatively, turn the wheels a little every month in order to prevent the tires from becoming degraded in one spot.
8. Cover the muffler outlets with plastic bags to prevent moisture from entering them.
9. Remove the battery and fully charge it. Store it in a cool, dry place and charge it once a month. Do not store the battery in an excessively cold or warm place [less than 0 °C (30 °F) or more than 30

°C (90 °F)]. For more information on storing the battery, see page 7-27.

TIP

Make any necessary repairs before storing the motorcycle.

Dimensions:

- Overall length:
 XVS650AZ 2450 mm (96.5 in)
 XVS650Z 2340 mm (92.1 in)
- Overall width:
 XVS650AZ 930 mm (36.6 in)
 XVS650Z 880 mm (34.6 in)
- Overall height:
 XVS650AZ 1110 mm (43.7 in)
 XVS650Z 1075 mm (42.3 in)
- Seat height:
 XVS650AZ 710 mm (28.0 in)
 XVS650Z 695 mm (27.4 in)
- Wheelbase:
 XVS650AZ 1625 mm (64.0 in)
 XVS650Z 1610 mm (63.4 in)
- Ground clearance:
 140 mm (5.51 in)
- Minimum turning radius:
 XVS650AZ 3400 mm (133.9 in)
 XVS650Z 3100 mm (122.0 in)

Weight:

- With oil and fuel:
 XVS650AZ 247.0 kg (545 lb)
 XVS650Z 233.0 kg (514 lb)

Engine:

- Engine type:
 Air cooled 4-stroke, SOHC
- Cylinder arrangement:
 V-type 2-cylinder
- Displacement:
 649 cm³
- Bore × stroke:
 81.0 × 63.0 mm (3.19 × 2.48 in)

Compression ratio:
 9.00 :1

Starting system:
 Electric starter

Lubrication system:
 Wet sump

Engine oil:

Recommended brand:
 YAMALUBE

Type:
 SAE 10W-30, 10W-40, 10W-50, 15W-40,
 20W-40 or 20W-50

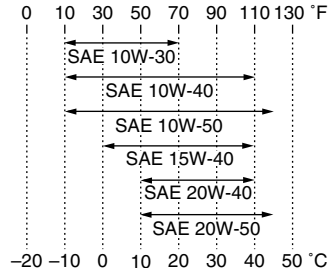

Recommended engine oil grade:
 API service SG type or higher, JASO
 standard MA

Engine oil quantity:
 Without oil filter element replacement:
 2.60 L (2.75 US qt, 2.29 Imp.qt)
 With oil filter element replacement:
 2.80 L (2.96 US qt, 2.46 Imp.qt)

Final gear oil:

Type:
 SAE 80 API GL-4 Hypoid gear oil

Quantity:
 0.19 L (0.20 US qt, 0.17 Imp.qt)

Air filter:

Air filter element:
 Dry element

Fuel:

Recommended fuel:
 Unleaded gasoline only

Fuel tank capacity:
 16.0 L (4.23 US gal, 3.52 Imp.gal)

Fuel reserve amount:
 3.0 L (0.79 US gal, 0.66 Imp.gal)

Carburetor:

Type × quantity:
 BDS28 x 2

Spark plug (s):

Manufacturer/model:
 NGK/DPR7EA-9

Manufacturer/model:
 DENSO/X22EPR-U9

Spark plug gap:
 0.8–0.9 mm (0.031–0.035 in)

Clutch:

Clutch type:
 Wet, multiple-disc

Transmission:

Primary reduction system:
 Spur gear

Primary reduction ratio:
 68/38 (1.789)

Secondary reduction system:
 Shaft drive

Secondary reduction ratio:
 19/18 × 32/11 (3.071)

SPECIFICATIONS

Transmission type:

Constant mesh 5-speed

Operation:

Left foot operation

Gear ratio:

1st:

38/14 (2.714)

2nd:

38/20 (1.900)

3rd:

35/24 (1.458)

4th:

28/24 (1.167)

5th:

29/30 (0.967)

Chassis:

Frame type:

Double cradle

Caster angle:

35.00 °

Trail:

XVS650AZ 145.0 mm (5.71 in)

XVS650Z 153.0 mm (6.02 in)

Front tire:

Type:

With tube

Size:

XVS650AZ 130/90-16M/C 67S

XVS650Z 100/90-19M/C 57S

Manufacturer/model:

XVS650AZ DUNLOP/D404F

XVS650Z BRIDGESTONE/EXEDRA L309

Rear tire:

Type:

With tube

Size:

170/80-15M/C 77S

Manufacturer/model:

XVS650AZ DUNLOP/D404G

XVS650Z BRIDGESTONE/EXEDRA G546

Loading:

Maximum load:

XVS650AZ 200 kg (441 lb)

XVS650Z 180 kg (397 lb)

(Total weight of rider, passenger, cargo and accessories)

Tire air pressure (measured on cold tires):

Loading condition:

0–90 kg (0–198 lb)

Front:

XVS650AZ 225 kPa (2.25 kgf/cm², 33 psi)

XVS650Z 200 kPa (2.00 kgf/cm², 29 psi)

Rear:

225 kPa (2.25 kgf/cm², 33 psi)

Loading condition:

XVS650AZ 90–200 kg (198–441 lb)

XVS650Z 90–180 kg (198–397 lb)

Front:

XVS650AZ 225 kPa (2.25 kgf/cm², 33 psi)

XVS650Z 200 kPa (2.00 kgf/cm², 29 psi)

Rear:

250 kPa (2.50 kgf/cm², 36 psi)

Front wheel:

Wheel type:

Spoke wheel

Rim size:

XVS650AZ 16M/C x MT3.00

XVS650Z 19M/C x MT2.50

Rear wheel:

Wheel type:

Spoke wheel

Rim size:

15M/C x MT3.50

Front brake:

Type:

Single disc brake

Operation:

Right hand operation

Recommended fluid:

DOT 4

Rear brake:

Type:

Drum brake

Operation:

Right foot operation

Front suspension:

Type:

Telescopic fork

Spring/shock absorber type:

Coil spring/oil damper

Wheel travel:

140.0 mm (5.51 in)

Rear suspension:

Type:

Swingarm (monocross)

Spring/shock absorber type:
Coil spring/gas-oil damper

Wheel travel:
XVS650AZ 98.0 mm (3.86 in)
XVS650Z 86.0 mm (3.39 in)

Electrical system:

Ignition system:
TCI (digital)

Charging system:
AC magneto

Battery:

Model:
GT12B-4

Voltage, capacity:
12 V, 10.0 Ah

Headlight:

Bulb type:
Halogen bulb

Bulb voltage, wattage × quantity:

Headlight:
12 V, 60 W/55 W × 1

Tail/brake light:
12 V, 5.0 W/21.0 W × 1

Front turn signal light:
12 V, 21.0 W × 2

Rear turn signal light:
12 V, 21.0 W × 2

Auxiliary light:
XVS650AZ 12 V, 4.0 W × 1

Meter lighting:
12 V, 1.7 W × 1

Neutral indicator light:
12 V, 1.7 W × 1

High beam indicator light:
12 V, 1.7 W × 1

Turn signal indicator light:
12 V, 1.7 W × 1

Engine trouble warning light:
12 V, 1.7 W × 1

Immobilizer system indicator light:
XVS650AZ LED

Fuses:

Main fuse:
30.0 A

Headlight fuse:
15.0 A

Signaling system fuse:
10.0 A

Ignition fuse:
10.0 A

Parking lighting fuse:
XVS650AZ 10.0 A

Carburetor heater fuse:
15.0 A

Backup fuse:
XVS650AZ 10.0 A

CONSUMER INFORMATION

Identification numbers

Record the key identification number, vehicle identification number and model label information in the spaces provided below for assistance when ordering spare parts from a Yamaha dealer or for reference in case the vehicle is stolen.

KEY IDENTIFICATION NUMBER:

VEHICLE IDENTIFICATION NUMBER:

MODEL LABEL INFORMATION:

<input type="radio"/>
<input type="radio"/>

EAU26352

Key identification number

XVS650Z

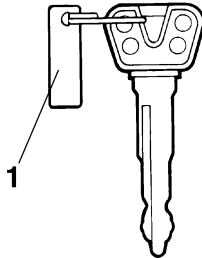

1. Key identification number

XVS650AZ

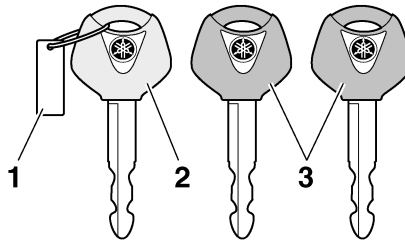

1. Key identification number
2. Code re-registering key (red bow)
3. Standard keys (black bow)

EAU26381

The key identification number is stamped into the key tag. Record this number in the space provided and use it for reference when ordering a new key.

EAU26400

Vehicle identification number

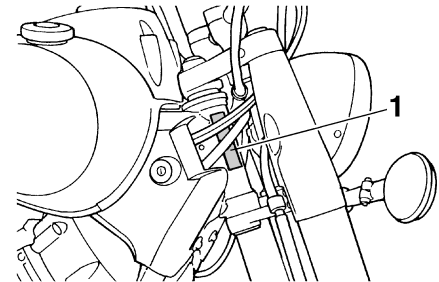

1. Vehicle identification number

The vehicle identification number is stamped into the steering head pipe. Record this number in the space provided.

TIP _____

The vehicle identification number is used to identify your motorcycle and may be used to register your motorcycle with the licensing authority in your area.

Model label

EAU26470

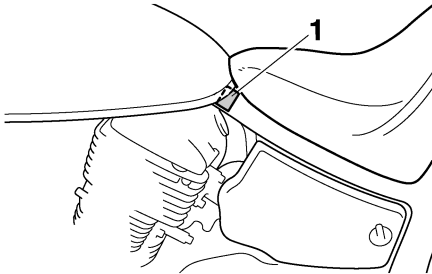

1. Model label

The model label is affixed to the frame under the rider seat. (See page 4-12.) Record the information on this label in the space provided. This information will be needed when ordering spare parts from a Yamaha dealer.

EAU26570

Motorcycle noise regulation (for Australia)

TAMPERING WITH NOISE CONTROL SYSTEM PROHIBITED:

Owners are warned that the law may prohibit:

- a. The removal or rendering inoperative by any person other than for purposes of maintenance, repair or replacement, of any device or element of design incorporated into any new vehicle for the purpose of noise control prior to its sale or delivery to the ultimate purchaser or while it is in use; and
- b. The use of the vehicle after such device or element of design has been removed or rendered inoperative by any person.

INDEX

A

- Air filter element, cleaning..... 7-13
- Auxiliary light bulb, replacing
(XVS650AZ) 7-32

B

- Battery..... 7-27
- Brake and clutch levers, checking and
lubricating 7-25
- Brake and shift pedals, checking and
lubricating 7-24
- Brake fluid, changing 7-23
- Brake fluid level, checking 7-22
- Brake lever 4-8
- Brake lever free play, adjusting..... 7-19
- Brake pads and shoes, checking 7-22
- Brake pedal..... 4-9
- Brake pedal position and free play,
adjusting 7-20

C

- Cables, checking and lubricating 7-23
- Carburetors, adjusting..... 7-14
- Care 8-1
- Clutch lever..... 4-7
- Clutch lever free play, adjusting..... 7-18

D

- Dimmer switch 4-6

E

- Engine break-in..... 6-3
- Engine idling speed..... 7-15
- Engine oil and oil filter element..... 7-9
- Engine, starting a warm 6-2
- Engine stop switch 4-7
- Engine trouble warning light..... 4-4

F

- Final gear oil 7-12
- Front fork, checking..... 7-26
- Fuel..... 4-10
- Fuel cock 4-11
- Fuel consumption, tips for reducing..... 6-3
- Fuel tank cap 4-9
- Fuses, replacing 7-29

H

- Handlebar switches 4-6
- Hazard switch (XVS650AZ)..... 4-7
- Headlight bulb, replacing..... 7-30
- Helmet holder 4-15
- High beam indicator light..... 4-4
- Horn switch..... 4-7

I

- Identification numbers 10-1
- Ignition circuit cut-off system 4-18
- Immobilizer system indicator light
(XVS650AZ) 4-5
- Immobilizer system (XVS650AZ)..... 4-1
- Indicator and warning lights..... 4-4

K

- Key identification number 10-1

L

- Labels, location..... 1-1
- Luggage strap holders..... 4-17

M

- Main switch/steering lock
(XVS650AZ) 4-2
- Main switch/steering lock (XVS650Z)..... 4-2
- Maintenance and lubrication, periodic.... 7-3
- Maintenance, emission control
system..... 7-2

- Matte color, caution..... 8-1
- Model label..... 10-2

N

- Neutral indicator light 4-4
- Noise regulation (for Australia)..... 10-2

P

- Panels, removing and installing 7-7
- Parking..... 6-4
- Part locations 3-1
- Pass switch 4-6

R

- Rear brake light switch, adjusting 7-21

S

- Safety information 2-1
- Seats (XVS650AZ)..... 4-13
- Seats (XVS650Z) 4-12
- Self-diagnosis device 4-6
- Shifting 6-2
- Shift pedal (XVS650AZ) 4-8
- Shift pedal (XVS650Z) 4-8
- Shock absorber assembly, adjusting 4-16
- Sidestand 4-17
- Sidestand, checking and lubricating..... 7-25
- Spark plugs, checking 7-8
- Specifications 9-1
- Speedometer unit..... 4-5
- Starter (choke) knob..... 4-12
- Starting and warming up a cold
engine 6-1
- Start switch..... 4-7
- Steering, checking..... 7-27
- Storage..... 8-3
- Storage compartment..... 4-15
- Supporting the motorcycle 7-32

Swingarm pivots, lubricating..... 7-26

T

Throttle cable free play, checking..... 7-15

Throttle grip and cable, checking and
lubricating..... 7-24

Tires..... 7-16

Tool kit..... 7-1

Troubleshooting..... 7-36

Troubleshooting chart..... 7-37

Turn signal indicator light..... 4-4

Turn signal light bulb or tail/brake light
bulb, replacing..... 7-31

Turn signal switch..... 4-6

V

Valve clearance..... 7-16

Vehicle identification number..... 10-1

W

Wheel bearings, checking..... 7-27

Wheel (front)..... 7-33

Wheel (rear)..... 7-34

Wheels..... 7-18



PRINTED ON RECYCLED PAPER

PRINTED IN JAPAN
2009.05-0.4×1 CR
(E)