

Z1000
Z1000 ABS

Motorcycle

OWNER'S MANUAL

 **Read this manual carefully. It contains safety information.**

Kawasaki

Quick Reference Guide

This Quick Reference Guide will assist you in finding the information you're looking for.

SAFETY INFORMATION

GENERAL INFORMATION

HOW TO RIDE THE MOTORCYCLE

MAINTENANCE AND ADJUSTMENT

APPENDIX

MAINTENANCE RECORD

A Table of Contents is included after the Foreword.

Whenever you see the symbols shown below, heed their instructions! Always follow safe operating and maintenance practices.

 **DANGER**

DANGER indicates a hazardous situation which, if not avoided, will result in death or serious injury.

 **WARNING**

WARNING indicates a hazardous situation which, if not avoided, could result in death or serious injury.

NOTICE

NOTICE is used to address practices not related to personal injury.

NOTE

○ *NOTE* indicates information that may help or guide you in the operation or service of the vehicle.

NOTICE

**THIS PRODUCT HAS BEEN
MANUFACTURED FOR USE IN A
REASONABLE AND PRUDENT
MANNER BY A QUALIFIED OP-
ERATOR AND AS A VEHICLE
ONLY.**

Foreword

Congratulations on your purchase of a new Kawasaki motorcycle. Your new motorcycle is the product of Kawasaki's advanced engineering, exhaustive testing, and continuous striving for superior reliability, safety and performance.

Please read this Owner's Manual carefully before riding so that you will be thoroughly familiar with the proper operation of your motorcycle's controls, its features, capabilities, and limitations. This manual offers many safe riding tips, but its purpose is not to provide instruction in all the techniques and skills required to ride a motorcycle safely. Kawasaki strongly recommends that all operators of this vehicle enroll in a motorcycle rider training program to attain awareness of the mental and physical requirements necessary for safe motorcycle operation.

To ensure a long, trouble-free life for your motorcycle, give it the proper care and maintenance described in this manual. For those who would like more detailed information on their Kawasaki Motorcycle, a Service Manual is available for purchase from any authorized Kawasaki motorcycle dealer. The Service Manual contains detailed disassembly and maintenance information. Those who plan to do their own work should, of course, be competent mechanics and possess the special tools described in the Service Manual.

Keep this Owner's Manual aboard your motorcycle at all times so that you can refer to it whenever you need information.

This manual should be considered a permanent part of the motorcycle and should remain with the motorcycle when it is sold.

All rights reserved. No part of this publication may be reproduced without our prior written permission.

This publication includes the latest information available at the time of printing. However, there may be minor differences between the actual product and illustrations and text in this manual.

All products are subject to change without prior notice or obligation.

KAWASAKI HEAVY INDUSTRIES, LTD.
Motorcycle & Engine Company

© 2014 Kawasaki Heavy Industries, Ltd.

May 30, 2014. (1)

(Australian model only)

TAMPERING WITH NOISE CONTROL SYSTEM PROHIBITED

Owners are warned that the law may prohibit:

- (a) The removal or rendering inoperative by any person other than for purposes of maintenance, repair or replacement, of any device or element of design incorporated into any new vehicle for the purpose of noise control prior to its sale or delivery to the ultimate purchaser or while it is in use; and
- (b) The use of the vehicle after such device or element of design has been removed or rendered inoperative by any person.

TABLE OF CONTENTS

SAFETY INFORMATION	10	GENERAL INFORMATION	21
Read Owner's Manual	10	Specifications	21
Training	10	Serial Number Locations	26
Daily Checks and Periodic Maintenance	10	Location of Labels	27
Loading and Accessories Information	11	Location of Parts	36
Passenger	12	Meter Instruments	39
Baggage and Luggage	13	Indicators	40
Accessories	13	Speedometer/Tachometer	47
Other Load	14	Display Setting	48
If You are Involved in an Accident ...	15	Features	55
Safe Operation	15	Keys	57
Carbon Monoxide Hazard	15	Ignition Switch/Steering Lock	59
Fueling	16	Right Handlebar Switches	61
Never Ride with Drugs or Alcohol.	16	Left Handlebar Switches	62
Protective Gear and Clothing	16	Brake Lever Adjuster	64
Safe Riding Techniques	17	Fuel Tank Cap	64
Additional Considerations for High Speed Operation	19	Fuel	66
		Fuel Requirements	66
		Filling the Tank	69
		Side Stand	70

Seats	71	Throttle Control System	110
Tying Hooks	73	Idle Speed	113
Tool Kit	73	Clutch	114
Rear View Mirror	74	Drive Chain	115
Event Data Recorder.....	75	Brakes	118
HOW TO RIDE THE MOTORCYCLE ..	77	Brake Light Switches.....	120
Break-In	77	Suspension System	123
Starting the Engine	78	Front Fork	123
Jump Starting	81	Rear Shock Absorber	126
Moving Off.....	83	Setting Tables	128
Shifting Gears	84	Wheels	131
Braking	85	Battery.....	134
Anti-lock Brake System (ABS)	86	Headlight.....	138
Stopping the Engine.....	89	Fuses	139
Stopping the Motorcycle in an		General Lubrication.....	141
Emergency	89	Cleaning Your Motorcycle	142
Parking	90	General Precautions	142
MAINTENANCE AND ADJUSTMENT ..	93	Washing Your Motorcycle	143
Daily Checks	95	APPENDIX	148
Periodic Maintenance.....	98	Storage	148
Engine Oil	103	Troubleshooting Guide.....	151
Coolant.....	107	OWNER SATISFACTION.....	152
Air Cleaner	109	Environmental Protection.....	154

MAINTENANCE RECORD 155

SAFETY INFORMATION

Read Owner's Manual

Read this Owner's Manual carefully before riding so that you will be thoroughly familiar with the proper operation of your motorcycle's controls, its features, capabilities, and limitations. This manual offers many safe riding tips, but its purpose is not to provide instruction in all of the techniques and skills required to ride a motorcycle safely.

Training

Kawasaki strongly recommends that all operators of this vehicle complete a suitable motorcycle rider training program to learn the proper skills and techniques necessary for safe motorcycle operation.

Daily Checks and Periodic Maintenance

It is important to keep your motorcycle properly maintained and in safe riding condition. Inspect your motorcycle before every ride and carry out all periodic maintenance. See the Daily Checks section and the Periodic Maintenance section in the MAINTENANCE AND ADJUSTMENT chapter for more information.

WARNING

Failure to perform these checks or to correct a problem before operation may result in serious damage or an accident. Always perform daily checks before operation.

To ensure your motorcycle is serviced using the latest servicing information, it is recommended that an authorized Kawasaki Dealer performs the periodic maintenance as directed in the Owner's Manual.

If you notice any irregular operating condition, have your motorcycle thoroughly checked at an authorized Kawasaki dealer as soon as possible.

Loading and Accessories Information

WARNING

Incorrect loading, improper installation or use of accessories or modification of your motorcycle may result in an unsafe riding condition. Before you ride the motorcycle, make sure it is not overloaded and that you have followed these instructions.

Maximum Load

Weight of rider, passenger, baggage, and accessories must not exceed 180 kg (397 lb).

With the exception of genuine Kawasaki Parts and Accessories, Kawasaki has no control over the design or application of accessories. In some cases, improper installation

12 SAFETY INFORMATION

or use of accessories, or motorcycle modification, will void the motorcycle warranty; can negatively affect performance, stability and safety; and can even be illegal.

In selecting and using accessories, and in loading the motorcycle, you are personally responsible for your own safety and the safety of other persons involved.

NOTE

○ *Kawasaki Parts and Accessories have been specially designed for use on Kawasaki motorcycles. We strongly recommend that all parts and accessories you add to your motorcycle be genuine Kawasaki components.*

Because a motorcycle is sensitive to changes in weight and aerodynamic forces, you must take extreme care in carrying cargo, passengers and/or in

fitting additional accessories. The following general guidelines have been prepared to assist you in making your determinations.

Passenger

1. Never carry more than one passenger.
2. The passenger should only sit on the pillion.
3. Any passenger should be thoroughly familiar with motorcycle operation. The passenger can affect control of the motorcycle by improper positioning during cornering and sudden movements. It is important that the passenger sits still while the motorcycle is in motion and not interfere with the operation of the motorcycle. Do not carry animals on your motorcycle.

4. Do not carry passengers unless passenger footpegs are installed. Instruct any passenger before riding to keep his or her feet on the passenger footpegs and hold on to the operator or seat strap. Do not carry a passenger unless he or she is tall enough to reach the footpegs with their feet.

Baggage and Luggage

1. All baggage should be carried as low as possible to reduce the effect on the motorcycle's center of gravity. Baggage weight should also be distributed equally on both sides of the motorcycle. Avoid carrying baggage that extends beyond the rear of the motorcycle.
2. Baggage should be securely attached. Make sure that the baggage

will not move around while you are riding. Recheck baggage security as often as possible (not while the motorcycle is in motion) and adjust as necessary.

3. Do not carry heavy or bulky items on a luggage rack. It is designed for light items, and overloading can affect handling due to changes in weight distribution and aerodynamic forces.

Accessories

1. Do not install accessories or carry baggage that impairs the performance of the motorcycle. Make sure that you have not adversely affected any lighting components, road clearance, banking capability (i.e., lean angle), control operation, wheel travel, front fork movement,

14 SAFETY INFORMATION

or any other aspects of the motorcycle's operation.

2. Weight attached to the handlebars or front fork will increase the mass of the steering assembly and can result in an unsafe riding condition.
3. Fairings, backrests, and other large items have the capability of adversely affecting stability and handling of the motorcycle, not only due to their weight, but also due to the aerodynamic force acting on these surfaces while the motorcycle is in operation. Poorly designed or installed items can result in an unsafe riding condition.

Other Load

1. This motorcycle is not intended to be equipped with a sidecar or to be used to tow any trailers or other vehicles. Kawasaki does not manufacture sidecars or trailers for motorcycles and cannot predict the effects of such accessories on handling or stability, but can only warn that the effects can be adverse and that Kawasaki cannot assume responsibility for the results of such unintended use of the motorcycle.
2. Furthermore, any adverse effects on motorcycle components caused by the use of such accessories will not be remedied under warranty.

If You are Involved in an Accident

Make sure of your own safety first. Determine the severity of any injuries and call for emergency assistance if needed. Always follow applicable laws and regulations if any other person, vehicle or property is involved.

Do not attempt to continue riding without first evaluating your motorcycle's condition. Inspect for fluid leaks, check critical nuts and bolts, and check the handlebars, control levers, brakes, and wheels for damage and proper function. Ride slowly and cautiously - your motorcycle may have suffered damage that is not immediately apparent. Have your motorcycle thoroughly checked at a Kawasaki dealer as soon as possible.

Safe Operation

The following should be carefully observed for safe and effective vehicle operation.

Carbon Monoxide Hazard

DANGER

Exhaust gas contains carbon monoxide, a colorless, odorless poisonous gas. Inhaling carbon monoxide can cause serious brain injury or death.

Do not run the engine in enclosed areas. Operate only in a well-ventilated area.

Fueling

 **WARNING**

Gasoline is extremely flammable and can be explosive under certain conditions.

To avoid a possible fire or explosion, turn the ignition switch to “OFF.” Do not smoke. Make sure the area is well ventilated and free from any source of flame or sparks; this includes any appliance with a pilot light.

Never Ride with Drugs or Alcohol

Alcohol and drugs impair your judgment and reaction time. Never consume alcohol or drugs before or while riding motorcycles.

Protective Gear and Clothing

Helmet

Kawasaki strongly recommends both the operator and passenger wear a helmet even if this is not a legal requirement.

- Make sure that your helmet fits correctly and is properly fastened.
- Choose a motorcycle helmet that meets the safety standards applicable to your country. Ask your motorcycle dealer to advise you if necessary.

Eye Protection

Always use eye protection. If your helmet does not have a visor installed, wear goggles.

Gloves

Wear gloves which have suitable protection for your hands, especially against abrasion.

Clothing

Wear protective clothing.

- Wear bright, highly visible clothing that allows freedom of movement to suit your riding style.
- Always wear a long-sleeved jacket and long trousers which are abrasion resistant and keep you warm.
- Avoid wearing clothes which have loose cuffs or other fastenings which could interfere with the controls of your motorcycle.

Boots

Wear proper protective boots that fit properly and do not interfere with gear shifting or braking.

Safe Riding Techniques

Keep Hands on Handlebars

When riding always keep both hands on the handlebars and both feet on the footpegs. Removing your hands from the handlebars or feet from the footpegs while riding can be hazardous. If you remove even one hand or foot, you reduce your ability to control the motorcycle.

Look Over Your Shoulder

Before changing lanes, look over your shoulder to make sure the way is clear. Do not rely solely on the rear

18 SAFETY INFORMATION

view mirror; you may misjudge a vehicle's distance and speed, or you may not see it at all.

Accelerate and Brake Smoothly

In general your actions should be smooth as sudden acceleration, braking or turning may cause loss of control, especially when riding in wet conditions or on loose road surfaces, when the ability to maneuver will be reduced.

Select Correct Gear Speeds

When going up steep slopes, shift to a lower gear so that there is power to spare rather than overloading the engine.

Use Both Front and Rear Brakes

When applying the brakes, use both the front and rear brakes. Applying only one brake for sudden braking may cause the motorcycle to skid and lose control.

Use Engine Brake

When going down long slopes, help control vehicle speed by closing the throttle so that the engine can act as an auxiliary brake. Use the front and rear brakes for primary braking.

Riding in Wet Conditions

Rely more on the throttle to control vehicle speed and less on the front and rear brakes. The throttle should also be used judiciously to avoid skidding the rear wheel from too rapid acceleration or deceleration.

Braking performance is also reduced in wet conditions. Carefully ride at a slow speed and apply the brakes several times to help dry and restores them to normal operating performance.

Lubricate the drive chain after wet-weather riding to prevent rust and corrosion.

Ride Prudently

Riding at the proper speed and avoiding unnecessarily fast acceleration are important not only for safety and low fuel consumption but also for long vehicle life and quieter operation.

Riding on Rough Roads

Exercise caution, slow down, and grip the fuel tank with the knees for better stability.

Acceleration

When quick acceleration is necessary to pass another vehicle, shift to a lower gear to obtain the necessary power.

Downshifting

To avoid engine damage and rear wheel lock-up do not downshift at high rpm.

Avoid Unnecessary Weaving

Unnecessary weaving jeopardizes the safety of both the rider and other motorists.

Additional Considerations for High Speed Operation

WARNING

Handling characteristics of a motorcycle at high speeds may vary from those you are familiar with at legal highway speeds. Do not attempt high speed operation unless you have received sufficient training and have the required skills.

Do not operate at high speeds on public roads.

20 SAFETY INFORMATION

Brakes

The importance of the brakes, especially during high speed operation, cannot be overemphasized. Check to see that they are correctly adjusted and functioning properly.

Steering

Looseness in the steering can cause loss of control. Check to see that the handlebars turns freely but has no play.

Tires

High speed operation is hard on tires, and good tires are crucial for safe riding. Examine their overall condition, inflate them to the proper pressure, and check the wheel balance.

Fuel

Have sufficient fuel for the high fuel consumption during high speed operation.

Engine Oil

To avoid engine seizure and resulting loss of control, make sure that the oil level is at the upper level line.

Coolant

To avoid overheating, check that the coolant level is at the upper level line.

Electrical Equipment

Make sure that the headlight, tail/brake light, turn signals, horn, etc., all work properly.

Miscellaneous

Make sure that all nuts and bolts are tight and that all safety related parts are in good condition.

GENERAL INFORMATION

Specifications

PERFORMANCE

Maximum Horsepower	104.5 kW (142 PS) @10 000 r/min (rpm)
(SEA-B1/B2, TH)	100.9 kW (137 PS) @9 800 r/min (rpm)
Maximum Torque	111 N·m (11.3 kgf·m, 81.9 ft·lb) @7 300 r/min (rpm)
(SEA-B1/B2, TH)	109 N·m (11.1 kgf·m, 80 ft·lb) @7 300 r/min (rpm)
Minimum Turning Radius	3.2 m (126 in.)

DIMENSIONS

Overall Length	2 045 mm (80.5 in.)
Overall Width	790 mm (31.1 in.)
Overall Height	1 055 mm (41.5 in.)
Wheelbase	1 435 mm (56.5 in.)
Road Clearance	125 mm (4.9 in.)

22 GENERAL INFORMATION

Curb Mass	(ZR1000F)	220 kg (485 lb)
	(ZR1000G)	221 kg (487 lb)

ENGINE

Type	DOHC, 4-cylinder, 4-stroke, liquid-cooled	
Displacement	1 043 cm ³ (63.6 cu in.)	
Bore × Stroke	77.0 × 56.0 mm (3.0 × 2.2 in.)	
Compression Ratio	11.8:1	
Starting System	Electric starter	
Cylinder Numbering Method	Left to right, 1-2-3-4	
Firing Order	1-2-4-3	
Fuel System	FI (Fuel Injection)	
Ignition System	Battery and coil (transistorized ignition)	
Ignition Timing (Electronically advanced)	10° BTDC @1 100 r/min (rpm) ~ 40.2° BTDC @5 200 r/min (rpm)	
Spark Plug:	Type	NGK CR9EIA-9
	Gap	0.8 ~ 0.9 mm (0.031 ~ 0.035 in.)
Lubrication System	Forced lubrication (wet sump)	

Engine Oil:	Type	API SG, SH, SJ, SL, or SM with JASO MA, MA1 or MA2
	Viscosity	SAE 10W-40
	Capacity	4.0 L (4.2 US qt)
Coolant Capacity		2.9 L (3.1 US qt)

TRANSMISSION

Transmission Type		6-speed, constant mesh, return shift
Clutch Type		Wet, multi disc
Driving System		Chain drive
Primary Reduction Ratio		1.627 (83/51)
Final Reduction Ratio		2.867 (43/15)
Overall Drive Ratio		5.165 (Top gear)
Gear Ratio:	1st	2.600 (39/15)
	2nd	1.950 (39/20)
	3rd	1.600 (24/15)
	4th	1.389 (25/18)
	5th	1.238 (26/21)
	6th	1.107 (31/28)

24 GENERAL INFORMATION

FRAME

Caster		24.5°
Trail		101 mm (3.98 in.)
Tire Size:	Front	120/70ZR17 M/C (58W)
	Rear	190/50ZR17 M/C (73W)
Rim Size:	Front	J17M/C × MT3.50
	Rear	J17M/C × MT6.00
Fuel Tank Capacity		17 L (4.5 US gal)
Brake Fluid:	Front	DOT4
	Rear	DOT4

ELECTRICAL EQUIPMENT

Battery		12 V 10 Ah (10 HR)
Headlight:	High Beam	LED
	Low Beam	LED
Brake/Tail Light		LED

SEA-B1: Southeast Asia B1 model (with Evaporative Emission Control System)

SEA-B2: Southeast Asia B2 model

TH: Thailand model

Even if one of LED (Light Emitting Diode) brake/tail light or headlight does not go on, consult with an authorized Kawasaki dealer.

Specifications are subject to change without notice, and may not apply to every country.

Serial Number Locations

The engine and frame serial numbers are used to register the motorcycle. They are the only means of identifying your particular machine from others of the same model type. These serial numbers may be needed by your dealer when ordering parts. In the event of theft, the investigating authorities will require both numbers as well as the model type and any peculiar features of your machine that can help them identify it.

Engine No.

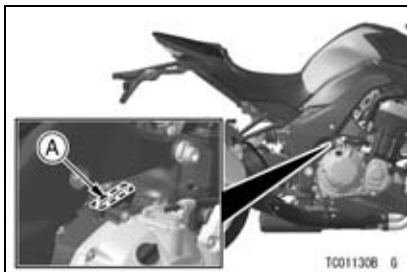

A. Engine Number

Frame No.

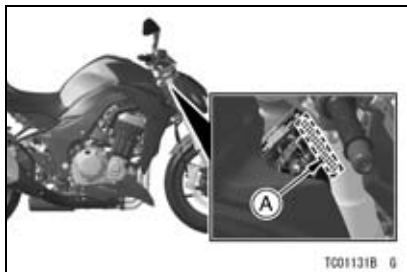

A. Frame Number

Location of Labels

All warning labels which are on your vehicle are repeated here. Read labels on your vehicle and understand them thoroughly. They contain information which is important for your safety and the safety of anyone else who may operate your vehicle. Therefore, it is very important that all warning labels be on your vehicle in the locations shown. If any label is missing, damaged, or worn, get a replacement from your Kawasaki dealer and install it in the correct position.

NOTE

- *The sample warning labels in this section have part numbers to help*

you and your dealer obtain the correct replacement.

- *Refer to the actual vehicle label for model specific data grayed out in the illustration.*

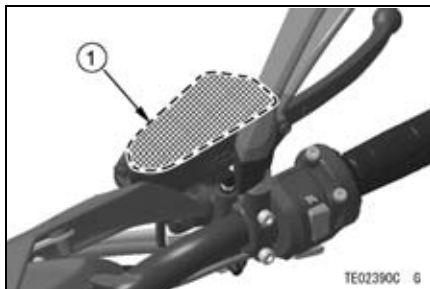

1. Brake Fluid (Front)

28 GENERAL INFORMATION

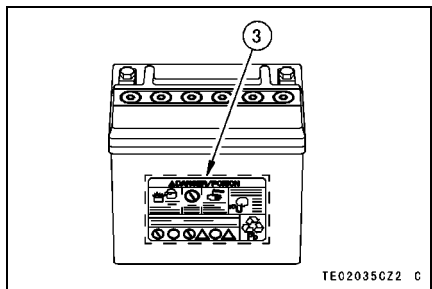
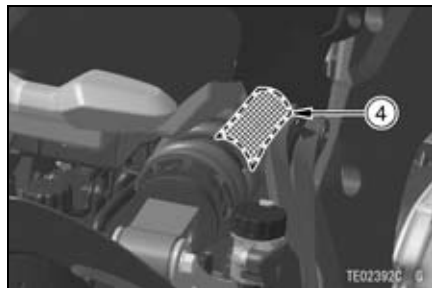
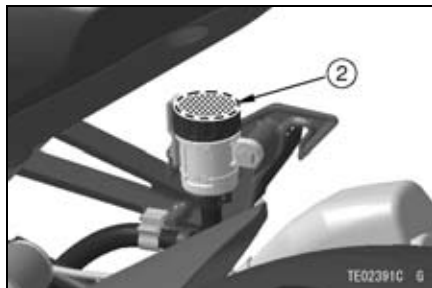

- 2. Brake Fluid (Rear)
- 3. Battery Poison/Danger
- 4. Rear Shock Absorber Warning

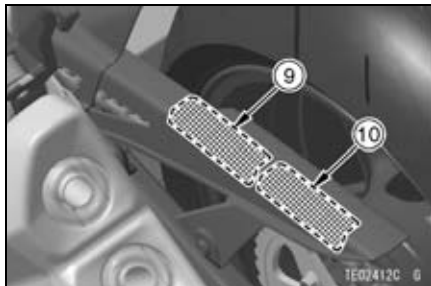
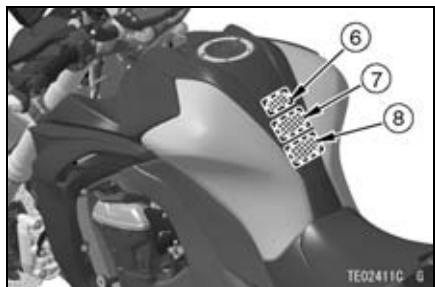

- 5. Radiator Cap Danger
- 6. Fuel Notice
- **7. Fuel Level
- *8. Helmet Wearing
- 9. Important Drive Chain Information
- 10. Tire and Load Data

*: only on Thailand model

** : only on Southeast Asia B1 model

30 GENERAL INFORMATION

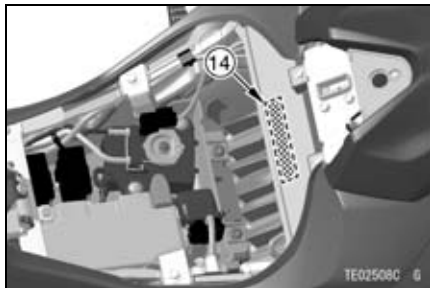
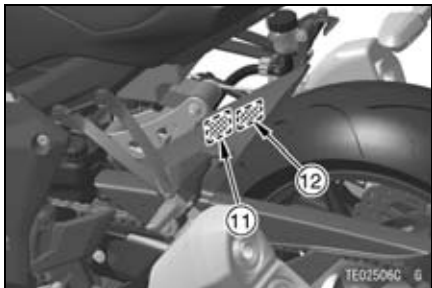

- ***11. Vacuum Hose Routing Diagram
- ****12. Vehicle Emission Control Information
- *****13. Stationary Noise Test Information
- ***** 14. Stationary Noise Test Information

- ***: only on Southeast Asia B1 and Thailand models
- ****: only on Philippines model
- *****: only on Australia model
- *****: only on Southeast Asia B2 and Thailand models

1)

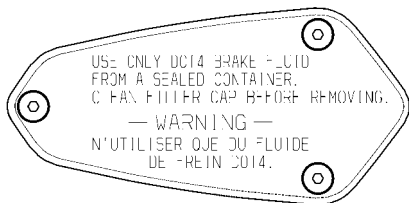

TE03928D S

2)

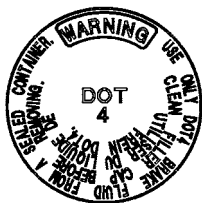

TE03879DN9 C

3)

⚠ DANGER/POISON			
 SHIELD EYES EXPLOSIVE GASES CAN CAUSE BLINDNESS OR INJURY.	 NO SPARKS • FLAMES • SMOKING	 SULFURIC ACID CAN CAUSE BLINDNESS OR SEVERE BURNS	FLUSH EYES IMMEDIATELY WITH WATER GET MEDICAL HELP FAST
KEEP OUT OF REACH OF CHILDREN			
IN U.S.A., SERVICED BY : READING, PA. 19605		YUASA BATTERY, INC. 19605	
			 LEAD RETURN RECYCLE Pb

TE03459D S

32 GENERAL INFORMATION

4)

▲ WARNING
This unit contains high pressure nitrogen gas. Mishandling can cause explosion. ● Do not incinerate, puncture or open.
▲ AVERTISSEMENT
Cette unité contient de l'azote à haute pression. Une mauvaise manipulation peut entraîner d'explosion. ● Ne pas brûler ni perforer ni ouvrir.
▲ 警告
高压窒素ガス入りです。 取り扱いを誤ると爆発する恐れがあります。 ● 火中への投入、穴あけ、分解はしないでください。

TE03460DN7 C

5)

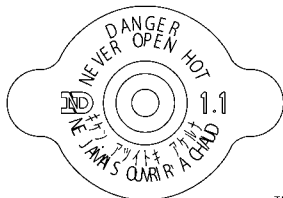

TE03353D S

6)

IMPORTANT
USE 95+OCTANE (RON) GASOLINE ONLY
<i>NOTICE</i> USE MINIMUM OF 95+OCTANE GASOLINE ONLY TO PREVENT SEVERE ENGINE DAMAGE.

56030-0359

TE03936DN9 C

7) only on Southeast Asia B1 model



56071-0158

TE03142C S

8) only on Thailand model



56071-0023

TE02995B S

9)

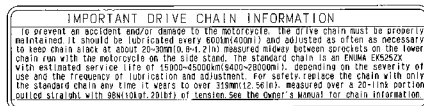

56033-0355

TE03922D S

34 GENERAL INFORMATION

10)

TIRE AND LOAD DATA			
The stability and handling characteristics of this motorcycle could become unsafe by the use of improper tire inflation pressures, over worn tires, unsuitable replacement tires, or over loading. When the tread wears down to the limit, replace the tires with only the standard tire. Maintain the inflation pressure specified.			
	Air Pressure (Cold)	Size & Valve Type (Tubeless Tire)	Minimum Tread Depth
Front	250 kPa (36 psi)	80/100-16M/C (65H) 80/100-16M/C (65H) 80/100-16M/C (65H)	1.6 mm (0.06 in)
Rear	290 kPa (42 psi)	80/100-16M/C (65H) 80/100-16M/C (65H) 80/100-16M/C (65H)	1.6 to 1.9 mm (0.063 to 0.075 in)

56053-0750

TE03008E S

11) only on Southeast Asia B1 and Thailand models

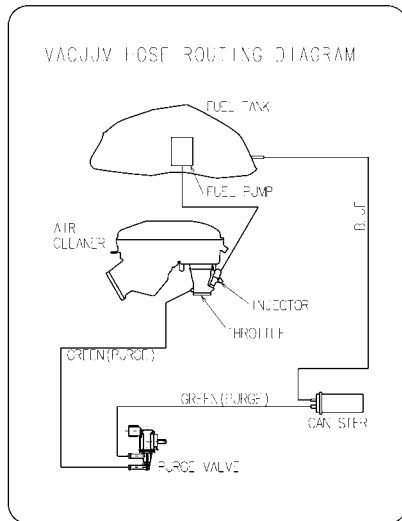

59465-1592

TE03056E S

12) only on Philippines model

ENGINE FAMILY CODE	V110	CO ₂ EMISSION CONTROL INFORMATION	
MODEL(S)		EXHAUST EMISSION CONTROL SYSTEM	
TYPE NO. SERIAL LEGAL NOS.		DISPLACEMENT	CC
TOP SPEED	XXXXXX RPM	SPARK PLUG	XXXX
SOLE AIR FUEL MIXTURE SETTING	NO ADJUSTMENT	SPARK PLUG GAP	XXXXMM
SOLE FUEL ADJUSTER	NO ADJUSTMENT	ENGINE OIL	SAE 15W 40
EXHAUST FILTER NO.	XXXXXXXXXX	TRANSMISSION OIL	API SG, SL, SH, SJ, SK, SN NIP JASO MA
Oil	XXXXXXXXXX		

THIS VEHICLE COMPLIES TO ISO 4021 BY DESIGN STANDARD OF THE PHILIPPINE
CLEAN AIR ACT (PCA) BY THE REGULATION - KAWASAKI MOTORS (PHILIPPINES) CORPORATION



TE03555D S

13) only on Australia model

STATIONARY NOISE TEST INFORMATION	
TESTED	XXXX dB(A) AT XXXX min ⁻¹
SILENCING SYSTEM : KAWASAKI HEAVY INDUSTRIES, LTD.	
IDENTIFICATION	: XXXX

TE03476DN9 C

14) only on Southeast Asia B2 and Thailand models

KAWASAKI HEAVY INDUSTRIES, LTD.	
Stationary Noise Test Information	
XXXX dB(A)	XXXX min ⁻¹

TE03057E S

Location of Parts

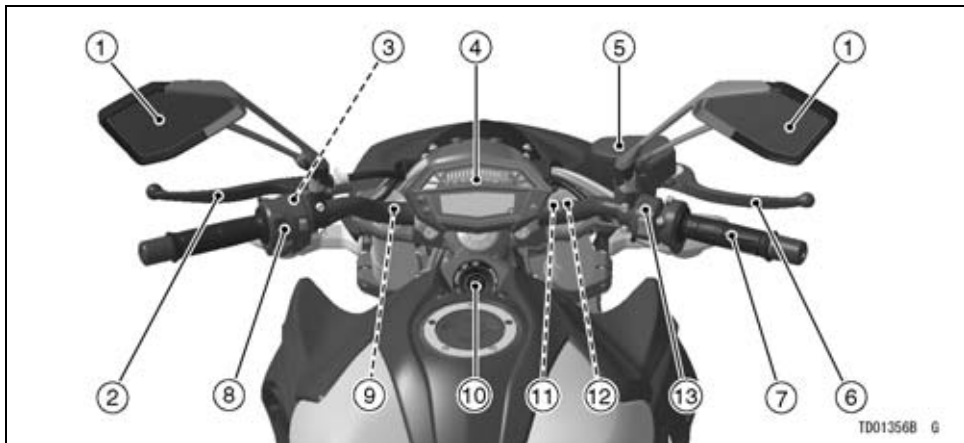

1. Rear View Mirrors
2. Clutch Lever
3. Starter Lockout Switch
4. Meter Instrument
5. Brake Fluid Reservoir (Front)
6. Front Brake Lever
7. Throttle Grip

8. Left Handlebar Switches
9. Spring Preload Adjuster
10. Ignition Switch/Steering Lock
11. Rebound Damping Force Adjuster
12. Compression Damping Force Adjuster
13. Right Handlebar Switches

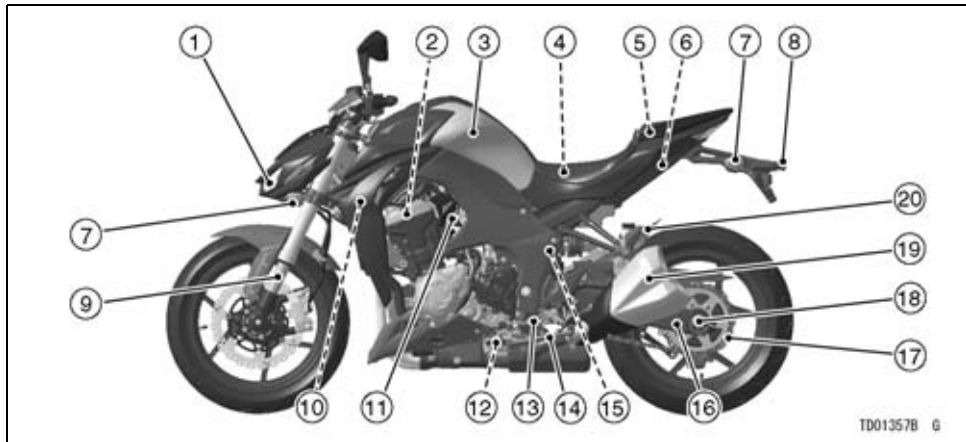

TD01357B G

1. Headlight
2. Spark Plugs
3. Fuel Tank
4. Battery
5. Tool Kit
6. Seat Lock
7. Turn Signal Lights
8. License Plate Light
9. Front Fork
10. Radiator

11. Idle Adjusting Screw
12. Side Stand Switch
13. Shift Pedal
14. Side Stand
15. Coolant Reserve Tank
16. Swingarm
17. Drive Chain
18. Chain Adjuster
19. Muffler
20. Tying Hook

38 GENERAL INFORMATION

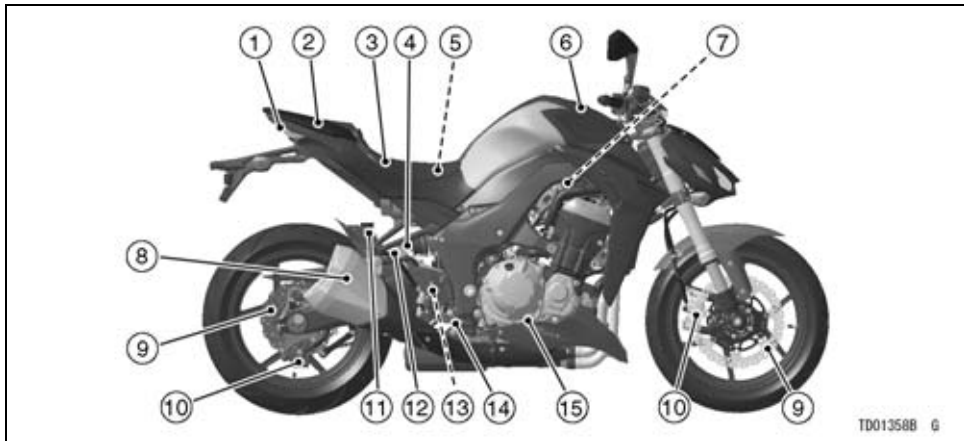

1. Tail/Brake Light
2. Passenger's Seat
3. Rider's Seat
4. Rear Shock Absorber
5. Fuse Boxes
6. Fuel Tank Cap
7. Air Cleaner
8. Muffler

9. Brake Discs
10. Brake Calipers
11. Brake Fluid Reservoir (Rear)
12. Rebound Damping Force Adjuster
13. Rear Brake Light Switch
14. Rear Brake Pedal
15. Oil Level Inspection Window





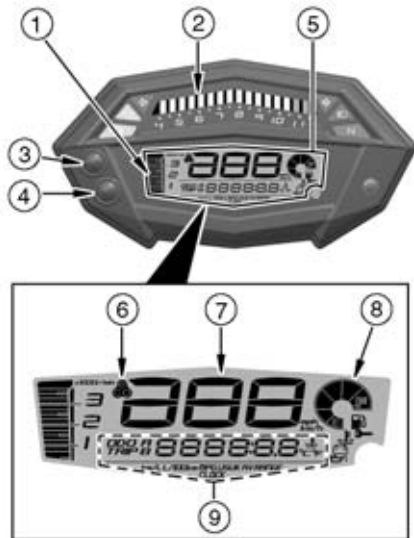

Meter Instruments

1. Tachometer [4 000 r/min (rpm) or less]
2. Tachometer [4 000 r/min (rpm) or more]
3. Upper Button
4. Lower Button
5. Multifunction Meter
6. Economical Riding Indicator
7. Speedometer
8. Fuel Gauge
9. Multifunction Display
 - Odometer
 - Trip Meter A/B
 - Current/Average Mileage/Cruising Range
 - Coolant Temperature Meter
 - Clock

When the ignition switch is turned on, all LCD functions are shown for a few seconds, then the multifunction meter turns to operational mode.



Indicators

1.  ABS Indicator (Yellow) (ABS model)
2.  Engine Warning Indicator (Yellow)
3.  Left Turn Signal Indicator (Green)
4.  Right Turn Signal Indicator (Green)
5.  High Beam Indicator (Blue)
6.  Neutral Indicator (Green)
7.  Fuel Level Warning Indicator
8.  Immobilizer Warning Indicator
9.  Coolant Temperature Warning Indicator
10.  Warning Indicator/Immobilizer Indicator (Red)
11.  Battery Warning Indicator
12.  Oil Pressure Warning Indicator

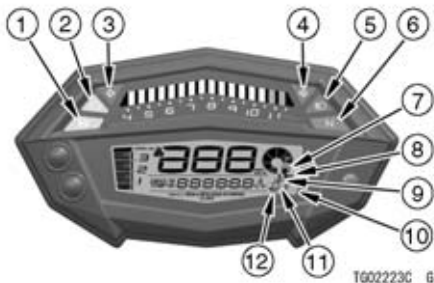

T602223C 6

Indicator Initial Operation

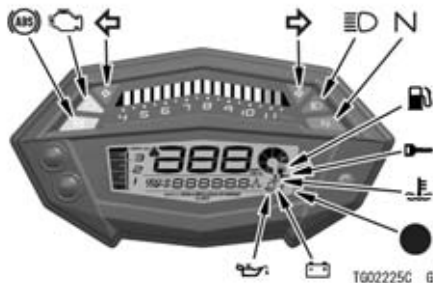

When the ignition switch is turned on, all indicators go on/off as shown in the table. If any indicator does not operate as shown, have it checked by an authorized Kawasaki dealer.

ON			Indicators
<input type="checkbox"/>	<input type="checkbox"/>	<input type="checkbox"/>	N *
<input type="checkbox"/>	<input type="checkbox"/>	<input checked="" type="checkbox"/>	
<input type="checkbox"/>	<input checked="" type="checkbox"/>	<input checked="" type="checkbox"/>	
<input checked="" type="checkbox"/>	<input checked="" type="checkbox"/>	<input checked="" type="checkbox"/>	

ON: When ignition switch is turned on.

: After a few seconds

: When engine starts.

: Goes on.



: Goes off.







* : goes off shortly after the motorcycle starts moving.

When Warning Indicators Go On or Blink





When warning indicators appear, there could be a problem with vehicle function. Follow actions in the table after stopping the vehicle in a safe place.

*: The numbers in this column corresponds to reference numbers on page 40.

*No.	Indicators	Status	Actions
1		ON* ¹	The ABS has malfunctioned. ABS will not work but conventional brakes function. Have the ABS checked by an authorized Kawasaki dealer.
2		ON	The DFI system has malfunctioned. Have it checked by an authorized Kawasaki dealer.
		Blink	If this indicator blinks while pushing the starter button, the vehicle-down sensor has been tripped and the engine cannot be started. Turn the ignition switch off and then back on to start the engine.

*No.	Indicators	Status	Actions
7		Blink	The lowest segment and fuel level warning indicator blink in the multifunction display when approximately 4.1 L (1.1 US gal) of usable fuel remains. Refuel at the earliest opportunity. If the vehicle is on the side stand, the warning indicator cannot estimate the amount of fuel in the tank. Stand the vehicle upright to check the fuel level.
		Blink (including all segments)	The fuel level warning system has malfunctioned. Have the fuel level warning system checked by an authorized Kawasaki dealer.
10 8	 	Blink	The immobilizer system has malfunctioned. These indicators blink if an improperly coded key is used or if there is a miscommunication between the antenna and key. Have the immobilizer system checked by an authorized Kawasaki dealer.
10 9	 	ON	These indicators go on whenever the coolant temperature rises to about 115°C (239°F). Refer to the Multifunction Display in the Display Setting section for more information and follow instructions in it.

44 GENERAL INFORMATION

*No.	Indicators	Status	Actions
10 11	 	ON	These indicators go on if the battery voltage is less than 11.0 V or more than 16.0 V. If they go on, charge the battery. If they still go on after charging the battery, have the battery and/or charging system checked by an authorized Kawasaki dealer.
10 12	 	ON	These indicators go on whenever the oil pressure is dangerously low or the ignition switch is in the "ON" position with the engine not running. If these indicators go on when the engine speed is above idle, stop the engine immediately and check the engine oil level. If the amount of engine oil is insufficient, add engine oil. If the oil level is good, have the engine checked by an authorized Kawasaki dealer.





*1: ABS indicator may go on:

- After continuous riding on a rough road.
- When the engine is started with the stand raised and the transmission engaged, and the rear wheel turns.
- When accelerating so abruptly that the front wheel leaves the ground.
- When the ABS has been subjected to strong electrical interference.
- When tire pressure is abnormal. Adjust tire pressure.
- When a tire different in size from the standard size is being used. Replace with standard size.
- When the wheel is deformed. Replace the wheel.

If this happens, first turn the ignition switch off, and then back on, and ride the motorcycle at 6 km/h (3.7 mph) or more. The ABS indicator should then go off. If it does not, have the ABS checked by an authorized Kawasaki dealer.

46 GENERAL INFORMATION

Other Indicators

*No.	Indicators	Status
3		When the turn signal switch is pushed to the left, this indicator blinks.
4		When the turn signal switch is pushed to the right, this indicator blinks.
5		When the headlight is on high beam, this indicator goes on.
6	N	When the transmission is in neutral, this indicator goes on.
10		When the ignition switch is turned off, this indicator will start blinking ^{*1} , which indicates that the immobilizer system is functioning. After 24 hours, the red warning indicator/immobilizer indicator will stop blinking. However, the immobilizer system is still functioning.

*1: The red warning indicator/immobilizer indicator blinking mode can be set to either on or off.

- To stop the red warning indicator/immobilizer indicator blinking, turn the ignition switch off and then, within twenty seconds, push and hold the upper and lower buttons simultaneously for more than two seconds.
- When the battery is connected, red warning indicator/immobilizer indicator defaults to blinking mode.
- When the battery voltage is low (below 12 V), the red warning indicator/immobilizer indicator automatically stops blinking to prevent excessive battery discharge.

Speedometer/Tachometer

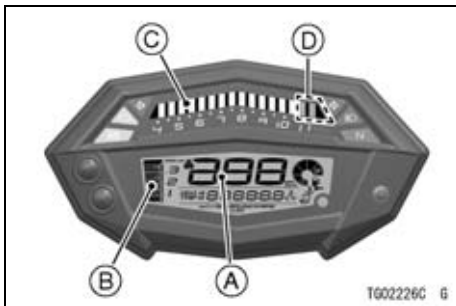

- A. Speedometer
- B. Tachometer (LCD)
- C. Tachometer (LED)
- D. Red Zone

Speedometer

The speedometer is digital and can be set for km/h or mph.

The unit setting can be changed according to local regulations. Make sure

the unit setting (km/h or mph) is correctly displayed before riding.

Refer to the Unit Setting in the Display Setting section.

Tachometer

The LCD display and LED display have tachometer function. The tachometer shows the engine speed in revolutions per minute (r/min, rpm). The tachometer (LCD) shows the value lower than 4 000 r/min. The tachometer (LED) do also the value higher than 4 000 r/min.

NOTICE

Engine speed should not be allowed to enter the red zone; operation in the red zone will overstress the engine and may cause serious engine damage.

48 GENERAL INFORMATION

When the ignition switch is turned on, the tachometer (LCD) segment(s) momentarily go from the minimum to the 4 000 r/min reading, then go back the minimum reading. At the same time, the tachometer (LED) segment(s) go from the both edges to the other sides, then go back to the both edge. If the tachometer does not operate correctly, have it checked by an authorized Kawasaki dealer.

Display Setting

Display Brightness Setting

The tachometer (LED) display brightness is auto set by the environment

light. When you feel too bright or too dark at looking the display, you can change the tachometer (LED) display brightness as follows.

 WARNING
--

For Safety, do not operate the meter buttons while riding the motorcycle.
--

- Push the upper and lower buttons, and hold them in until the all tachometer segments go on.
- Push the upper button to select the brightness.

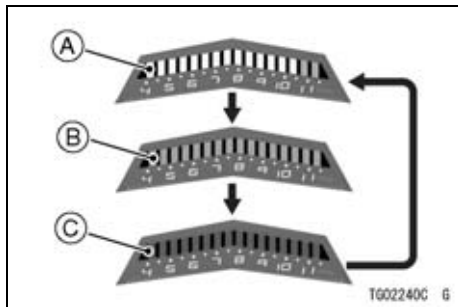

- A. Brightest Setting (Standard)
- B. Medium Setting
- C. Darkest Setting

NOTE

- You can select the brightness from 3 settings.
- Push the upper and lower buttons, and hold them in until the all segments go off.

NOTE

- You can not change the mode of the multifunction meter while set the display brightness.
- The display brightness can not be changed while the input value to the speedometer is more than 5 km/h (4 mph).

Multifunction Display

- Push the upper button to select the display modes. The display modes can be shifted in the following order.

NOTE

- The multifunction display is displayed in the unit depending on the unit mode setting.
- When the battery is reconnected, the meter display is set to odometer by default.

50 GENERAL INFORMATION

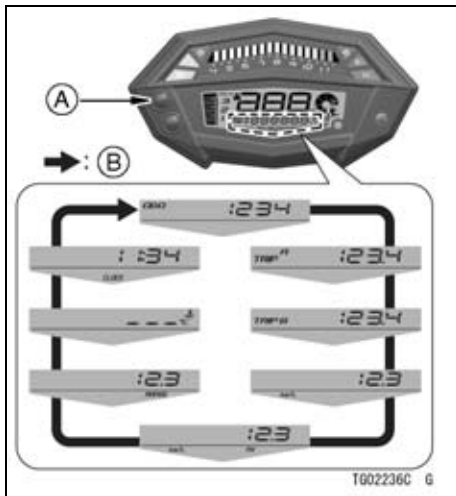

A. Upper Button

B. Flow when pushing upper button

Odometer

The odometer shows the total distance. This meter cannot be reset.



NOTE

- When the figures come to 999999, the display is stopped and locked.

Trip Meter

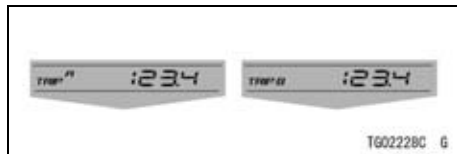

To reset the trip meter:

- Push the upper button to select the trip meter A or B.
- Push the lower button and hold it in until the display turns to 0.0.

NOTE

- *When the trip meter reaches 9999.9 while riding, the meter resets to 0.0 and continues counting.*

Current Mileage

The current mileage display is renewed every 4 seconds.

**NOTE**

- *When the ignition switch is turned on, the numerical value shows “- -.-.” After a few seconds of riding the numerical value is displayed.*
- *When the ignition switch is turned off, the current mileage resets to “0.0.”*

Average Mileage

This display mode shows the average fuel consumption from the reset. The average mileage display is renewed every 5 seconds.

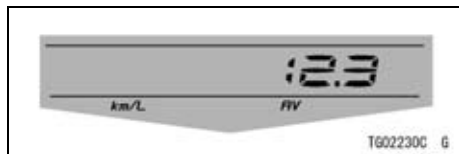

To reset the average mileage:

- Push the lower button and hold it in until the average mileage values resets to “- -.-.”

NOTE

- *When the battery is disconnected, the average mileage resets to “- -.-.”*
- *After resetting the average mileage, the numerical value is not displayed until the vehicle has travelled 100 m (328 ft).*

52 GENERAL INFORMATION

Cruising Range

This display shows the cruising range by numerical value, and indicates the cruising range from the remaining fuel in the fuel tank. This cruising range display is renewed every 20 seconds.



NOTE

- *The cruising range value is no longer shown if the fuel level gets too low after the fuel level warning indicator starts blinking.*
- *To recover the cruising range value display add fuel to at least the level needed for the fuel level warning indicators to stop blinking. The cruising range may still be displayed with*

a low fuel level, but it will not be accurate until enough fuel is added to stop the fuel level warning indicator from blinking.

Coolant Temperature Meter

The coolant temperature meter indicates temperature of the engine coolant.

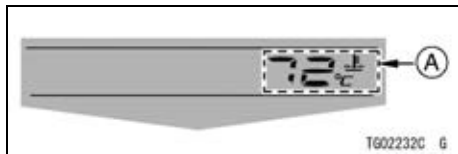

A. Coolant Temperature Meter

If the coolant temperature is below 40°C (104°F), "—" is displayed.



If the coolant temperature rises to above 115°C (239°F) and below 120°C (248°F), the numerical value of the current coolant temperature starts blinking, the warning indicator/immobilizer indicator and coolant temperature warning indicator also go on. This warns the operator that the coolant temperature is high.

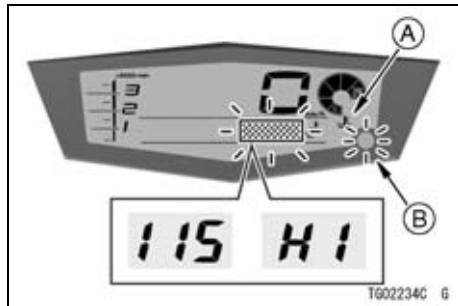

- A. Coolant Temperature Warning Indicator**
B. Warning Indicator/Immobilizer Indicator (Red)

If the coolant temperature rises to 120°C (248°F) or more, "HI" is displayed and starts blinking, the warning indicator/immobilizer indicator and coolant temperature warning indicator also go on. Stop the engine and check the coolant level in the reserve tank after the engine cools down. If the amount of the coolant is insufficient,

54 GENERAL INFORMATION

add coolant to the reserve tank. If the coolant level is good, have the cooling system checked by an authorized Kawasaki dealer.

NOTICE

Stop the engine if the coolant temperature shows "HI." Prolonged engine operation will result in severe engine damage from overheating.

NOTE

- *The other display modes shift to the coolant temperature meter automatically if the coolant temperature rises to above 115°C (239°F).*

Clock

To adjust the clock:

- Push the upper button to select the clock.

- Push the lower button and hold it until both the hour and minute displays blink.

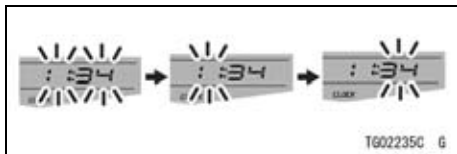

- Push the lower button to select the hour or minute digits.
- Push the upper button to adjust the hour or minute digits.
- To finish the adjustment, push the upper button when both the hour and minute digits blink.

NOTE

- *When the battery is disconnected, the clock is reset to 1:00 and starts working again when the battery is connected.*

Unit Setting

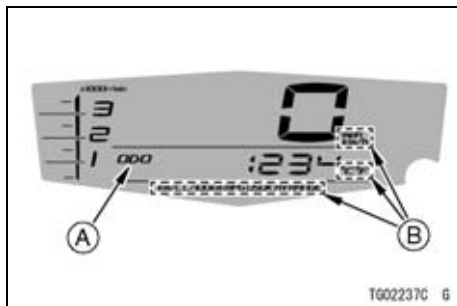

- A. Odometer
B. Units

- Display the odometer in the multi-function display.
- Push the lower button while pushing the upper button to select the meter display units. The display units can be shifted in the following order.

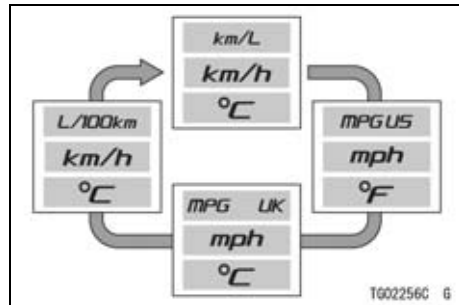

Features

Economical Riding Indicator

When riding the motorcycle efficiently, the economical riding indicator appears on the multifunction meter to indicate favorable fuel consumption. Monitoring the economical riding indicator can help the rider maximize fuel efficiency.



A. Economical Riding Indicator

⚠ WARNING

Failing to properly observe the road ahead increases the chance of an accident resulting in severe injury or death. Do not concentrate on the economical riding indicator by taking your eyes off the road; observe using peripheral vision.

Fuel Gauge

The fuel in the fuel tank is shown by the number of segments displayed.

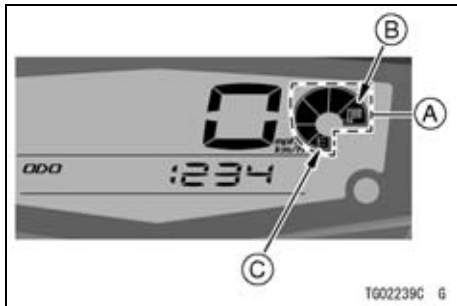

- A. Segments
- B. F (full)
- C. E (empty)

NOTE

- When the fuel tank is full, all the segments are displayed. As the fuel level in the tank goes down, the segments disappear one by one from F (full) to E (empty).

- *When the fuel level warning indicator and E (empty) blink, refer to the “When Warning Indicators Go On or Blink” of Indicators in this chapter.*

Keys

This motorcycle has a combination key, which is used for the ignition switch/steering lock, seat lock, and fuel tank cap.

Immobilizer System

This motorcycle is equipped with an immobilizer system to protect your motorcycle from theft. This motorcycle has two ignition keys. Store the one

ignition key and the key tag in a safe place. If all ignition keys are lost, registering new codes for replacement ignition keys into the electronic control unit is impossible. Registering additional ignition key should be done by an authorized Kawasaki dealer. Blank keys are available at your Kawasaki dealers. Ask your dealer to make any additional spare keys you may need, using your original key as a master. To make additional ignition keys, take the vehicle along with all ignition keys to an authorized Kawasaki dealer to have them re-registered. Up to five ignition keys can be registered with the immobilizer system at one time.

NOTICE

Do not put two keys of any immobilizer system on the same key ring.

Do not submerge any key in water.

Do not expose any key to excessively high temperature.

Do not place any key close to magnets.

Do not place heavy item on any key.

Do not grind any key or alter its shape.

Do not disassemble the plastic part of any key.

Do not drop any key and/or apply shocks to it.

If a ignition key is lost, re-registry at dealer is securely required to prevent the possibility of theft.

NOTICE

If all ignition keys are lost, an authorized Kawasaki dealer will have to replace the ECU and order new ignition keys.

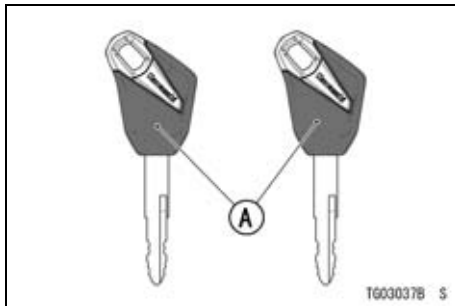

A. Ignition Keys

- Ignition keys: You can register maximum 5 ignition keys at one time.

If an improperly coded key is used or any incorrect communication between ECU and key is occurred, the engine does not start with the immobilizer warning indicator () and warning indicator/immobilizer indicator blinks.

A properly coded key must be used and the communication should be clear for the engine to start.

When the key is turned to “OFF,” the warning indicator/immobilizer indicator will start blinking, which indicates that the immobilizer system is functioning. After 24 hours have passed, the warning indicator/immobilizer indicator will stop blinking, however the immobilizer system is still functioning.

If all ignition keys are lost, registering new ignition key codes is impossible and the ECU must be replaced.

EC Directive Compliance

This immobilizer system complies with the R & TTE (Radio equipment and telecommunications terminal equipment and the mutual recognition of their conformity) Directive.

Ignition Switch/Steering Lock

This is a four-position, key-operated switch. The key can be removed from the switch when it is in the “OFF,” “LOCK” or “  ” position.

60 GENERAL INFORMATION

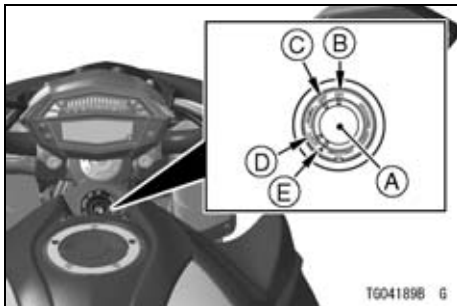

- A. Ignition Switch/Steering Lock
- B. ON position
- C. OFF position
- D. LOCK position
- E.  position

ON	Engine on. All electrical equipment can be used.
OFF	Engine off. Electrical circuits off.
LOCK	Steering locked. Engine off. Electrical circuits off.
	Steering locked. Engine off. Turn signals can be used. Other electrical circuits off.

NOTE

- *The tail, city and license plate lights are on whenever the ignition key is in the “ON” position. Headlights (Low beam) go on when the starter button is released after starting the engine. To avoid battery discharge, always start the engine immediately after turning the ignition key to “ON.”*
- *If you leave the “ON” position on for a long time, the battery may become totally discharged.*

Right Handlebar Switches

To operate the ignition switch:

LOCK ← OFF ↔ ON



1. Turn the handlebars fully to the left.
2. For locking push down the key in the OFF position and turn it to LOCK.

TG04182BZ2 C

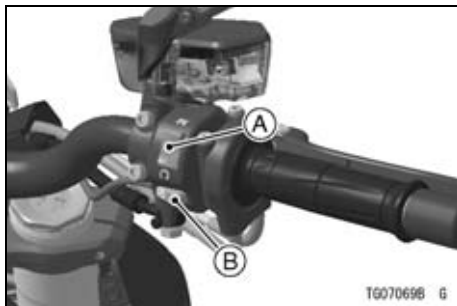

TG070698 G

- A. Engine Stop Switch
- B. Starter Button

Engine Stop Switch

In addition to the ignition switch, the engine stop switch must be in the  position for the motorcycle to operate.

62 GENERAL INFORMATION

The engine stop switch is for emergency use. If required, move the switch to the  position.

NOTE

○ *Although the engine stop switch stops the engine, it does not turn off all the electrical circuits. Ordinarily, the ignition switch should be used to stop the engine.*

Starter Button

The starter button operates the electric starter when the transmission is in neutral.

Refer to the Starting the Engine section in the HOW TO RIDE THE MOTORCYCLE chapter for starting instructions.

Left Handlebar Switches

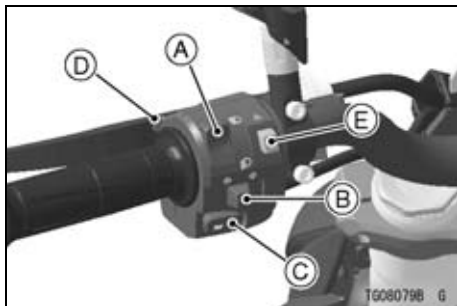

- A. Dimmer Switch
- B. Turn Signal Switch
- C. Horn Button
- D. Passing Button
- E. Hazard Switch

Dimmer Switch

High or low beam can be selected with the dimmer switch. When the headlight is on high beam (), the high beam indicator goes on.

High beam.....()

Low beam.....()





A. High Beams

B. Low Beams

NOTE

- *When the headlight is on high beam, all headlights go on. When the headlight is on low beam, only two headlights go on.*

Turn Signal Switch

When the turn signal switch is turned to the left () or right (), the corresponding turn signals blink on and off.

To stop blinking, push the switch in.

Horn Button

When the horn button is pushed, the horn sounds.

Passing Button

When the passing button is pushed, the headlight high beam (passing beam) goes on to signal the driver of the vehicle ahead that you are about to pass. The passing light is shut off as soon as the button is released.

Hazard Switch

If an emergency requires you to park on the highway shoulder, turn on the hazard lights to warn other drivers of your location.

64 GENERAL INFORMATION

Push in the hazard switch with the ignition switch in the “ON” or “ \triangle ” position. All the turn signal lights and turn signal indicators will blink on and off.

NOTICE

Be careful not to use the hazard lights for more than 30 minutes, otherwise the battery may become totally discharged.

Brake Lever Adjuster

There is an adjuster on the brake lever. The adjuster has 6 positions so that the released lever position can be adjusted to suit the operator's hands. Push the lever forward and turn the adjuster to align the number with the mark on the lever holder. The distance from

the grip to the released lever is minimum at Number 6 and maximum at Number 1.

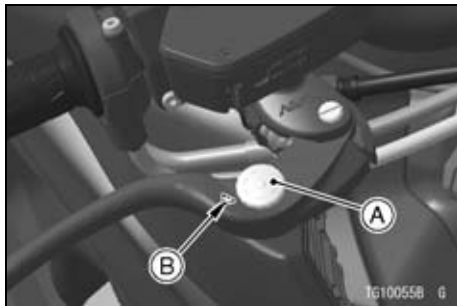

- A. Adjuster
- B. Mark

Fuel Tank Cap

To open the fuel tank cap, pull up the key hole cover. Insert the ignition key into the fuel tank cap and turn the key clockwise.

To close the cap, push it down into place with the key inserted. The key can be removed by turning counterclockwise to the original position. Close the key hole cover.

NOTE

- *The fuel tank cap cannot be closed without the key inserted, and the key cannot be removed unless the cap is locked properly.*
- *Do not push on the key to close the cap, or the cap cannot be locked.*

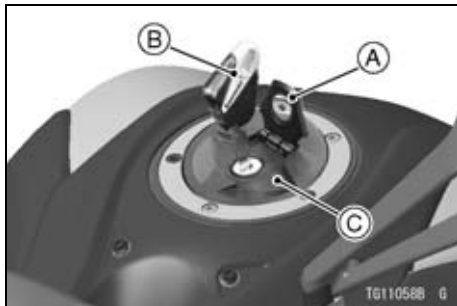

- A. Key Hole Cover
- B. Ignition Key
- C. Fuel Tank Cap

Fuel

Fuel Requirements

Your Kawasaki engine is designed to use only unleaded gasoline with a minimum octane rating shown below. Never use gasoline with an octane rating lower than the minimum specified by Kawasaki to prevent severe engine damage.

The octane rating of a gasoline is a measure of its resistance to detonation or “knocking”. The term commonly used to describe a gasoline’s octane rating is the Research Octane Number (RON).

NOTICE

Do not use leaded gasoline, as this will destroy the catalytic converter.

NOTICE

If engine “knocking” or “pinging” occurs, use a different brand of gasoline of a higher octane rating. If this condition is allowed to continue, it can lead to severe engine damage. Gasoline quality is important. Fuels of low quality or not meeting standard industry specifications may result in unsatisfactory performance. Operating problems that result from the use of poor quality or no recommended fuel may not be covered under your warranty.

Fuel Type and Octane Rating**(Except for Brazil, Philippine and Thailand Specifications)**

Use clean, fresh unleaded gasoline with an octane rating equal to or higher than that shown in the table.

Fuel Type	Unleaded Gasoline
Minimum Octane Rating	Research Octane Number (RON) 95

NOTICE

Do not use any fuel with an ethanol in this vehicle. It has not been tested and certified for use with such fuels. Damage to the engine and fuel system, or engine starting and/or performance problems may result from the use of improper fuel.

(For Brazil Specification)

Use clean, fresh unleaded gasoline with an Antiknock Index equal to or higher than that shown in the table.

The Antiknock Index is posted on service station pumps. The Antiknock Index is an average of the Research Octane Number (RON) and the Motor Octane Number (MON) as shown in the table.

Fuel Type	Unleaded Gasoline
Ethanol Content	E25
Minimum Octane Rating	Antiknock Index $\frac{\text{RON} + \text{MON}}{2}$ 90

NOTICE

Do not use any fuel that contains more ethanol or other oxygenates than specified for E25 fuel* in this vehicle. Damage to the engine and fuel system, or engine starting and/or performance problems may result from the use of improper fuel.

*E25 means fuel containing up to 25% ethanol.

(For Philippine and Thailand Specifications)

Use clean, fresh unleaded gasoline with an ethanol volume content not more than 10% and an octane rating equal to or higher than that shown in the table.

Fuel Type	Unleaded Gasoline
Ethanol Content	E10 or less
Minimum Octane Rating	Research Octane Number (RON) 95

NOTICE

Do not use any fuel that contains more ethanol or other oxygenates than specified for E10 fuel* in this vehicle. Damage to the engine and fuel system, or engine starting and/or performance problems may result from the use of improper fuel.

*E10 means fuel containing up to 10% ethanol.

Filling the Tank

Avoid filling the tank in the rain or where heavy dust is blowing so that the fuel does not get contaminated.

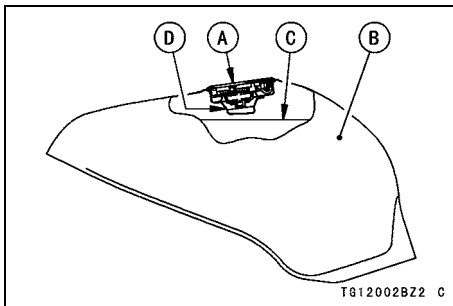

- A. Tank Cap
- B. Fuel Tank
- C. Top Level
- D. Filler Neck

⚠ WARNING

Gasoline is extremely flammable and can be explosive under certain conditions, creating the potential for serious burns. Turn the ignition switch off. Do not smoke. Make sure the area is well ventilated and free from any source of flame or sparks; this includes any appliance with a pilot light. Never fill the tank completely to the top. If the tank is filled completely to the top, heat may cause the fuel to expand and overflow through the vents in the tank cap. After refueling, make sure the tank cap is closed securely. If gasoline is spilled on the fuel tank, wipe it off immediately.

NOTICE

Certain ingredients of gasoline may cause paint fading or damage. Be extra careful not to spill fuel during refueling.

Side Stand

The motorcycle is equipped with the side stand.

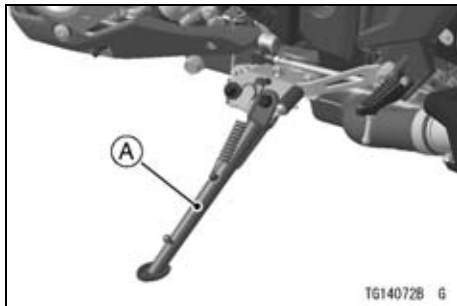

A. Side Stand

NOTE

○ *When using the side stand, turn the handlebars to the left.*

Do not sit on the motorcycle while it is on its side stand. Always kick the stand fully up before sitting on the motorcycle.

NOTE

- *The motorcycle is equipped with a side stand switch. This switch is designed so that the engine does not start if the transmission is in gear and the side stand is down.*

Seats*Rider's Seat Removal***⚠ WARNING**

The muffler quickly becomes very hot soon after the engine is started and can cause serious burns. To avoid burns, be careful not to touch the muffler when operating the seat lock.

- Insert the ignition key into the seat lock.

- Pull up the rear of rider's seat while turning the key clockwise.
- Remove the rider's seat backward.

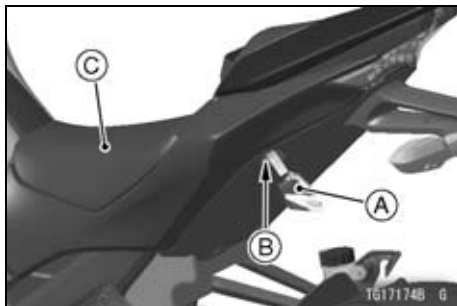

- A. Ignition Key
- B. Seat Lock
- C. Rider's Seat

Rider's Seat Installation

- Insert the tabs at the front of the rider's seat under the fuel tank bracket.

72 GENERAL INFORMATION

- Insert the hook at the rear of the rider's seat into the hole on the frame.
- Push down the rear part of the rider's seat until the lock clicks.

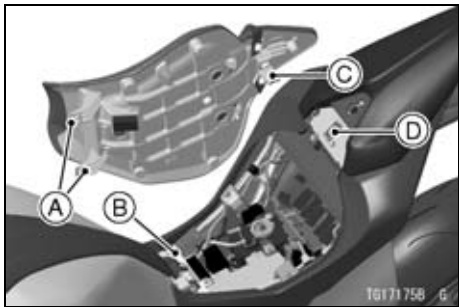

- A. Tabs
- B. Fuel Tank Bracket
- C. Hook
- D. Hole

- Pull up the front and rear ends of the rider's seat to make sure they are securely locked.

Passenger's Seat Removal

- Remove the rider's seat (see Rider's Seat Removal).
- Pull off the passenger's seat backward.

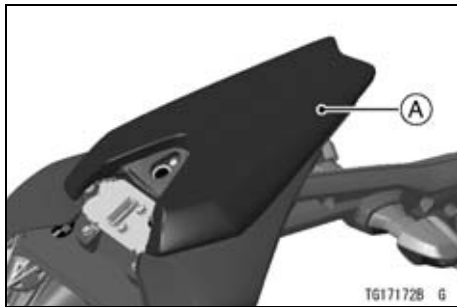

- A. Passenger's Seat

Passenger's Seat Installation

- Insert the tabs at the rear of the passenger's seat under the frame bracket.

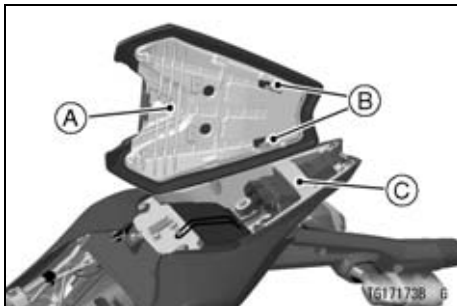

A. Passenger's Seat

B. Tabs

C. Frame Bracket

- Install the rider's seat (see Rider's Seat Installation).

Tying Hooks

When tying up light loads to the seat, use the tying hooks located in rear of the rear footpegs.



A. Tying Hooks

Tool Kit

The tool kit is located under the passenger's seat.

The kit contains tools that can be helpful in making roadside repairs, adjustments, and some maintenance procedures explained in this manual. Keep the tool kit in the original place.

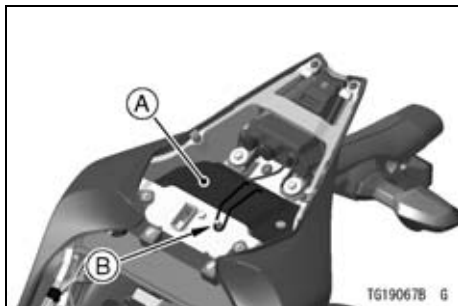

- A. Tool Kit
- B. Band

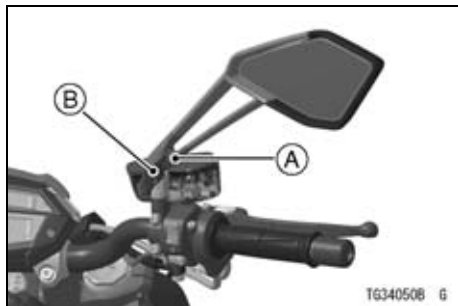

- A. Mirror Stay Cover Mounting Bolt
- B. Mirror Stay Cover

- Loosen the locknut and turn the stay by hand.

Rear View Mirror

Rear View Mirror Adjustment

- Adjust the rear view mirror as follows.
- Remove the mirror stay cover mounting bolt.
- Slide down the mirror stay cover and remove it.

NOTE

- *The locknut has left hand threads.*

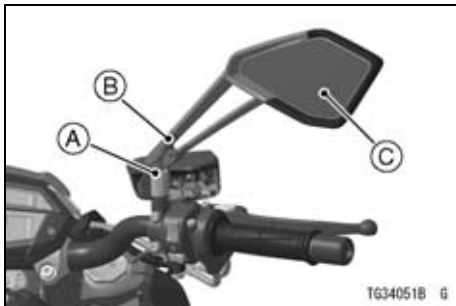

- A. Locknut**
B. Stay
C. Rear View Mirror

- Tighten the locknut.

Tightening Torque

Rear View Mirror Locknut:
 18 N·m (1.8 kgf·m, 13 ft·lb)

- Be sure to install the pad on the mirror stay cover.
- Install the mirror stay cover.

- Tighten the mirror stay cover mounting bolt.

Tightening Torque

Mirror Stay Cover Mounting Bolt:
 3.4 ~ 4.9 N·m (0.35 ~ 0.50 kgf·m, 30
 ~ 43 in·lb)

Event Data Recorder

In common with many other vehicle manufacturers, Kawasaki has equipped this motorcycle with an event data recorder (EDR). The purpose of this device is to record data, only in accident situation, that assists with understanding of how a vehicle's systems were performing during a short period of time immediately before and during an accident (event).

NOTE

- *During normal riding data is recorded but is constantly overwritten and then erased when the ignition is switched off.*
- *At no time other than in the event of an accident is EDR data stored for retrieval.*
- *This device does not collect or store personal data or information (e.g. name, gender, age).*

This data can help provide a better understanding for both the rider and the manufacturer of how the vehicle was performing at the time of an accident and of the circumstances in which crashes occur.

The EDR in this vehicle is designed to record only data that is relevant to the vehicle's running condition at the time of an accident such information as:

- Vehicle speed,
- Engine crankshaft rotational speed, and
- Throttle opening.

To access information on an EDR, special equipment and access to the EDR is required. Kawasaki will not share EDR information without obtaining your consent, unless required by government authorities, or acting pursuant to lawful authority.

HOW TO RIDE THE MOTORCYCLE

Break-In

The first 1 600 km (1 000 mile) that the motorcycle is ridden is designated as the break-in period. If the motorcycle is not used carefully during this period, you may very well end up with a “broken down” instead of a “broken in” motorcycle after a few thousand kilometers.

The following rules should be observed during the break-in period.

- The table shows maximum recommended engine speed during the break-in period.

Distance traveled	Maximum engine speed
0 ~ 800 km (0 ~ 500 mile)	4 000 r/min (rpm)
800 ~ 1 600 km (500 ~ 1 000 mile)	6 000 r/min (rpm)

NOTE

- *When operating on public roadways, keep maximum speed under traffic law limits.*
- Do not start moving or race the engine immediately after starting it, even if the engine is already warm. Run the engine for two or three minutes at idle speed to give the oil a chance to work up into all the engine parts.

78 HOW TO RIDE THE MOTORCYCLE

- Do not race the engine while the transmission is in neutral.

⚠ WARNING

New tires are slippery and may cause loss of control and injury. A break-in period of 160 km (100 miles) is necessary to establish normal tire traction. During break-in, avoid sudden and maximum braking and acceleration, and hard cornering.

In addition to the above, at 1 000 km (600 mile) it is extremely important that the owner has the initial maintenance service performed by an authorized Kawasaki dealer.

Starting the Engine

- Check that the engine stop switch is in the  position.

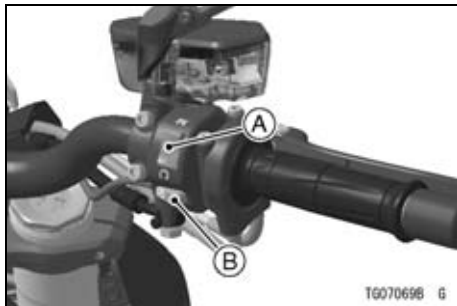

- A. Engine Stop Switch**
- B. Starter Button**

- Turn the ignition key to “ON” position.
- Make sure the transmission is in neutral.

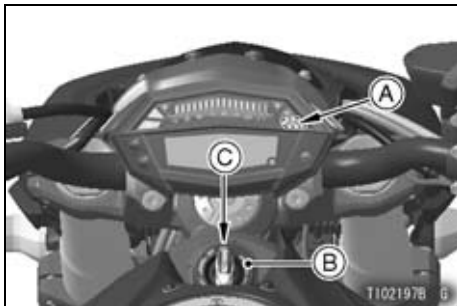

- A. Neutral Indicator (Green)
- B. Ignition Switch
- C. ON position

NOTE

- *While the engine is cold, the fast idle system automatically raises the engine idling speed. At this time, the*

engine warning indicator () may go on if you operate the throttle grip unnecessarily.

- *The motorcycle is equipped with a vehicle-down sensor which causes the engine to stop automatically if the motorcycle falls down. The engine warning indicator () blinks when the starter button is pressed if the engine cannot be started. After righting the motorcycle, first turn the ignition key to “OFF” and then back to “ON” before starting the engine.*
- *Without holding the throttle grip, push the starter button to start the engine.*

NOTICE

Do not operate the starter continuously for more than 5 seconds, or the starter will overheat and the battery power will drop temporarily. Wait 15 seconds between each operation of the starter to let it cool and the battery power recover.

NOTE

- *The motorcycle is equipped with a starter lockout switch. This switch is designed so that the engine does not start if the transmission is in gear and the side stand is down. However, the engine can be started if the clutch lever is pulled and the side stand is fully up.*

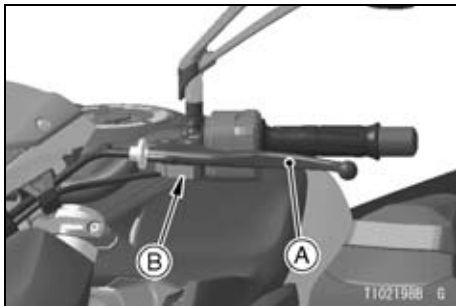

- A. Clutch Lever
- B. Starter Lockout Switch

NOTICE

Do not let the engine idle longer than five minutes, or engine overheating and damage may occur.

Jump Starting

If your motorcycle battery is “run down”, it should be removed and charged. If this is not practical, a 12 volt booster battery and jumper cables may be used to start the engine.

DANGER

Battery acid generates hydrogen gas which is flammable and explosive under certain conditions. It is present within a battery at all times, even in a discharged condition. Keep all flames and sparks (cigarettes) away from the battery. Wear eye protection when working with a battery. In the event of battery acid contact with skin, eyes, or clothing, wash the affected areas immediately with water for at least five minutes. Seek medical attention.

Connecting Jumper Cables

- Make sure the ignition switch is turned off.

82 HOW TO RIDE THE MOTORCYCLE

- Remove the rider's seat (see Seats section in the GENERAL INFORMATION chapter).
- Slide the red cap from the positive (+) terminal (see Battery section in the MAINTENANCE AND ADJUSTMENT chapter).
- Connect a jumper cable from the positive (+) terminal of the booster battery to the positive (+) terminal of the motorcycle battery.

NOTICE

Be careful not to contact the jumper cable slip on the positive battery terminal to the frame, or it will cause a short circuit.

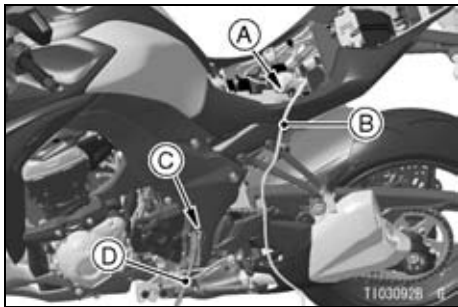

- A. Motorcycle Battery Positive (+) Terminal**
- B. From Booster Battery Positive (+) Terminal**
- C. Swingarm Pivot Shaft Nut**
- D. From Booster Battery Negative (-) Terminal**

- Connect another jumper cable from the negative (-) terminal of the booster battery to your motorcycle swingarm pivot shaft nut or other unpainted metal surface. Do not use the negative (-) terminal of the battery.

 DANGER

Batteries contain sulfuric acid that can cause burns and produce hydrogen gas which is highly explosive. Do not make this last connection at the fuel system or battery. Take care not to touch the positive and negative cables together, and do not lean over the battery when making this last connection. Do not connect to a frozen battery. It could explode. Do not reverse polarity by connecting positive (+) to negative (-), or a battery explosion and serious damage to the electrical system may occur.

- Follow the standard engine starting procedure.

NOTICE

Do not operate the starter continuously for more than 5 seconds or the starter will overheat and the battery power will drop temporarily. Wait 15 seconds between each operation of the starter to let it cool and the battery power recover.

- After the engine has started, disconnect the jumper cables. Disconnect the negative (-) cable from the motorcycle first.
- Install the removed parts.

Moving Off

- Check that the side stand is up.
- Pull in the clutch lever.
- Shift into 1st gear.

84 HOW TO RIDE THE MOTORCYCLE

- Open the throttle a little, and start to let out the clutch lever very slowly.
- As the clutch starts to engage, open the throttle a little more, giving the engine just enough fuel to keep it from stalling.

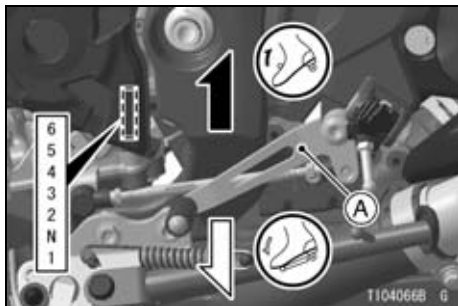

A. Shift Pedal

NOTE

- *The motorcycle is equipped with a side stand switch. This switch is designed so that the engine does not start if the transmission is in gear and the side stand is down.*

Shifting Gears

- Close the throttle while pulling in the clutch lever.
- Shift into the next higher or lower gear.
- Open the throttle part way, while releasing the clutch lever.

WARNING

Downshifting to a lower gear at high speed causes engine rpm to increase excessively, potentially damaging the engine and it may also cause the rear wheel to skid and cause an accident. Downshifting should be done below 5 000 rpm for each gear.

NOTE

- *The transmission is equipped with a positive neutral finder. When the motorcycle is standing still, the transmission cannot be shifted past neutral from 1st gear. To use the positive neutral finder, shift down to 1st gear, then lift up on the shift pedal while standing still. The transmission will shift only into neutral.*

Braking

- Close the throttle completely, leaving the clutch engaged (except when shifting gears) so that the engine will help slow down the motorcycle.
- Shift down one gear at a time so that you are in 1st gear when you come to a complete stop.
- When stopping, always apply both brakes at the same time. Normally the front brake should be applied a little more than the rear. Shift down or fully disengage the clutch as necessary to keep the engine from stalling.
- Never lock the brakes, or it will cause the tires to skid. When turning a corner, it is better not to brake at all. Reduce your speed before you get into the corner.
- For emergency braking, disregard downshifting, and concentrate on

86 HOW TO RIDE THE MOTORCYCLE

applying the brakes as hard as possible without skidding.

- Even in motorcycles equipped with ABS, braking during cornering may cause wheel slip. When turning a corner, it is better to limit braking to the light application of both brakes or not to brake at all. Reduce your speed before you get into the corner.

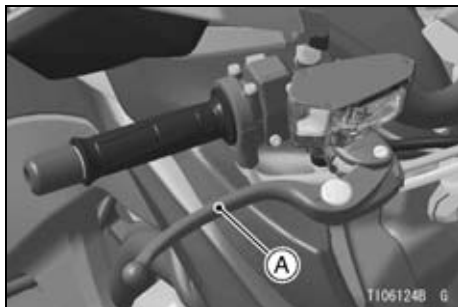

A. Front Brake Lever

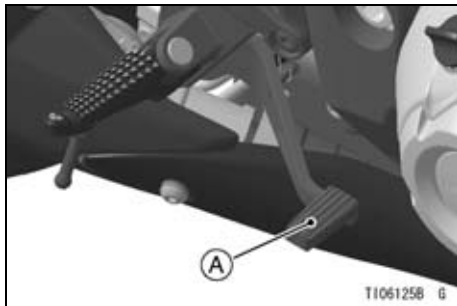

A. Rear Brake Pedal

Anti-lock Brake System (ABS)

(Only on ABS model)

ABS is designed to help prevent the wheels from locking up when the brakes are applied hard while running straight. The ABS automatically regulates brake force. Intermittently gaining gripping force and braking force helps

prevent wheel lock-up and allows stable steering control while stopping.

Brake control function is identical to that of a conventional motorcycle. The brake lever is used for the front brake and the brake pedal for the rear brake.

Although the ABS provides stability while stopping by preventing wheel lock-up, remember the following characteristics:

- To apply the brake effectively, use the front brake lever and rear brake pedal simultaneously in the same manner as conventional motorcycle brake system.
- ABS cannot compensate for adverse road conditions, misjudgment or improper application of brakes. You must take the same care as with motorcycles not equipped with ABS.
- ABS is not designed to shorten the braking distance. On loose, uneven

or downhill surfaces, the stopping distance of a motorcycle with ABS may be longer than that of an equivalent motorcycle without ABS. Use special caution in such areas.

- ABS will help prevent wheel lock-up when braking in a straight line, but it cannot control wheel slip which may be caused by braking during cornering. When turning a corner, it is better to limit braking to the light application of both brakes or not to brake at all. Reduce your speed before you get into the corner.
- Same as conventional brake system, an excessive sudden braking may cause wheel lock up that makes it harder to control a motorcycle.
- During braking, ABS will not prevent the rear wheel lifting.

⚠ WARNING

ABS cannot protect the rider from all possible hazards and is not a substitute for safe riding practices. Be aware of how the ABS system operates and its limitations. It is the rider's responsibility to ride at appropriate speeds and manner for weather, road surface and traffic conditions.

- The computers integrated in the ABS compare vehicle speed with wheel speed. Since non-recommended tires can affect wheel speed, they may confuse the computers, which can extend braking distance.

⚠ WARNING

Use of non-recommended tires may cause malfunctioning of ABS and can lead to extended braking distance. The rider could have an accident as a result. Always use recommended standard tires for this motorcycle.

NOTE

- *When the ABS is functioning, you may feel a pulsing in the brake lever or pedal. This is normal. You need not suspend applying brakes.*
- *ABS does not function at speeds of approx. 6 km/h (3.7 mph) or below.*

- *ABS does not function if the battery is discharged. When riding with an insufficiently charged battery, ABS may not function. Keep the battery in good condition according to the “Battery Maintenance” section.*

Stopping the Engine

- Close the throttle completely.
- Shift the transmission into neutral.
- Turn the ignition key to “OFF.”
- Support the motorcycle on a firm, level surface with the side stand.
- Lock the steering.

NOTE

- *The motorcycle is equipped with a vehicle-down sensor which causes the engine to stop automatically if the motorcycle falls down. The engine warning indicator () blinks when*

the starter button is pressed if the engine cannot be started. After righting the motorcycle, first turn the ignition key to “OFF” and then back to “ON” before starting the engine.

Stopping the Motorcycle in an Emergency

Your Kawasaki Motorcycle has been designed and manufactured to provide you optimum safety and convenience. However, in order to fully benefit from Kawasaki’s safety engineering and craftsmanship, it is essential that you, the owner and operator, properly maintain your motorcycle and become thoroughly familiar with its operation. Improper maintenance can create a dangerous situation known as throttle failure. Two of the most common causes of throttle failure are:

90 HOW TO RIDE THE MOTORCYCLE

1. An improperly serviced or clogged air cleaner may allow dirt and dust to enter the throttle body and stick the throttle open.
2. During removal of the air cleaner, dirt is allowed to enter and jam the fuel injection system.

In an emergency situation such as throttle failure, your vehicle may be stopped by applying the brakes and disengaging the clutch. Once this stopping procedure is initiated, the engine stop switch may be used to stop the engine. If the engine stop switch is used, turn off the ignition switch after stopping the motorcycle.

Parking



WARNING

Operating or parking the vehicle near flammable materials can cause a fire, and can result in property damage or severe personal injury.

Do not idle or park your vehicle in an area where tall or dry vegetation, or other flammable materials could come into contact with the muffler or exhaust pipe.

 **WARNING**

The engine and exhaust system get extremely hot during normal operation and can cause serious burns.

Never touch a hot engine, exhaust pipe, or muffler during operation or after stopping the engine.

- Shift the transmission into neutral and turn the ignition key to “OFF.”
- Support the motorcycle on a firm, level surface with the side stand.

NOTICE

Do not park on a soft or steeply inclined surface, or the motorcycle may fall over.

- If parking inside a garage or other structure, be sure it is well ventilated and the motorcycle is not close to any source of flame or sparks; this includes any appliance with a pilot light.

 **WARNING**

Gasoline is extremely flammable and can be explosive under certain conditions, creating the potential for serious burns. Turn the ignition switch to “OFF.” Do not smoke. Make sure the area is well ventilated and free from any source of flame or sparks; this includes any appliance with a pilot light.

- Lock the steering to help prevent theft.

NOTE

- *When stopping near traffic at night, you can leave the turn signals blinking for greater visibility by turning the ignition key to the  position and push in the hazard switch.*

MAINTENANCE AND ADJUSTMENT

The maintenance and adjustments outlined in this chapter must be carried out in accordance with the Daily Checks and Periodic Maintenance to keep the motorcycle in good running condition and to reduce air pollution. **The initial maintenance is vitally important and must not be neglected.**

WARNING

Failure to perform these checks or to correct a problem before operation may result in serious damage or an accident. Always perform daily checks before operation.

With a basic knowledge of mechanics and the proper use of tools, you should be able to carry out many of the maintenance items described in this chapter. If you lack proper experience or doubt your ability, all adjustments, maintenance, and repair work should be completed by a qualified technician.

Please note that Kawasaki cannot assume any responsibility for damage resulting from incorrect or improper adjustment made by the owner.

 **DANGER**

Exhaust gas contains carbon monoxide, a colorless, odorless poisonous gas. Inhaling carbon monoxide can cause serious brain injury or death. **DO NOT** run the engine in enclosed areas. Operate only in a well-ventilated area.

 **WARNING**

The cooling fan spins at high speed and can cause serious injuries. Keep your hands and clothing away from the cooling fan blades at all times.

NOTE

- *If a torque wrench is not available, the maintenance items which require a specific torque value should be serviced by an authorized Kawasaki dealer.*

Daily Checks

Check the following items each day before you ride. The time required is minimal, and habitual performance of these checks will help ensure you a safe, reliable ride.

If any irregularities are found during these checks, refer to the MAINTENANCE AND ADJUSTMENT chapter or see your dealer for the action required to return the motorcycle to a safe operating condition.

Operation	See Page
Fuel Adequate supply in tank, no leaks	—
Engine oil Oil level between level lines	103
Tires Air pressure (when cold), install the air valve cap Tire wear	131 132
Drive chain Slack Lubricate if dry	116 115

96 MAINTENANCE AND ADJUSTMENT

Operation	See Page
Bolt, nuts and fasteners Check for loose and/or missing bolts, nuts and fasteners	—
Steering Action smooth but not loose from lock to lock No binding of control cables	— —
Brakes Brake pad wear Brake fluid level No brake fluid leakage	120 118 —
Throttle Throttle grip play	110
Clutch Clutch lever play Clutch lever operates smoothly	114 —
Coolant No coolant leakage	—

Operation	See Page
Coolant level between level lines (when engine is cold)	107
Electrical equipment All lights (head, tail/brake, turn signal, warning/indicator) and horn work	—
Engine stop switch Stops engine	—
Side stand Return to its fully up position by spring tension Return spring not weak or not damaged	— —
Rear view mirrors Rear view sight	—

Periodic Maintenance

- *A: Service at number of years shown or indicated odometer reading intervals, whichever comes first.
- *B: For higher odometer readings, repeat at the frequency interval established here.
- *C: Service more frequently when operating in severe conditions: dusty, wet, muddy, high speed, or frequent starting/stopping.
- *D: Southeast Asia B1 and Thailand models only

: Inspection



























: Dealer Inspection

: Change or Replace

: Dealer Change or Replace





























: Lubrication

: Dealer Lubrication

Items	year (*A)	Odometer Reading (*B) × 1 000 km (× 1 000 mile)					See Page
		1 (0.6)	6 (3.8)	12 (7.6)	18 (11.4)	24 (15.2)	
Air cleaner element (*C)							109
Idle speed							113
Throttle control system (play, smooth return, no drag)	 :1						110
Engine vacuum synchronization							–
Fuel system	 :1						–
Fuel hose	 :5						–
Evaporative emission control system (*D)							–
Coolant level							107
Cooling system	 :1						–

100 MAINTENANCE AND ADJUSTMENT

Items	year (*A)	Odometer Reading (*B) × 1 000 km (× 1 000 mile)					See Page
		1 (0.6)	6 (3.8)	12 (7.6)	18 (11.4)	24 (15.2)	
Coolant, water hoses and O-rings	:3	: every 36 000 km (22 500 mile)					–
Valve clearance		: every 42 000 km (26 250 mile)					–
Air suction system							–
Clutch operation (play, engagement, disengagement)							114
Engine oil and oil filter (*C)	:1						104
Tire air pressure	:1						131
Wheels and tires	:1						131
Wheel bearing damage	:1						–
Drive chain lubrication condition (*C)		: every 600 km (400 mile)					115

Items	year (*A)	Odometer Reading (*B) × 1 000 km (× 1 000 mile)					See Page
		1 (0.6)	6 (3.8)	12 (7.6)	18 (11.4)	24 (15.2)	
Drive chain slack (*C)		 : every 1 000 km (600 mile)					116
Drive chain wear (*C)							–
Drive chain guide wear							–
Brake system	 :1						–
Brake operation (effectiveness, play, no drag)	 :1						–
Brake fluid level	 :0.5						118
Brake fluid (front and rear)	 :2						–
Brake hose	 :4						–
Rubber parts of brake master cylinder and caliper	 :4	 : every 48 000 km (30 000 mile)					–

102 MAINTENANCE AND ADJUSTMENT

Items	year (*A)	Odometer Reading (*B) × 1 000 km (× 1 000 mile)					See Page
		1 (0.6)	6 (3.8)	12 (7.6)	18 (11.4)	24 (15.2)	
Brake pad wear (*C)			Q	Q	Q	Q	120
Brake light switch operation		Q	Q	Q	Q	Q	120
Suspension system	Q:1			Q		Q	–
Steering play	Q:1	Q		Q		Q	–
Steering stem bearings	W:2					W	–
Electrical system	Q:1			Q		Q	–
Spark plugs				W		W	–
Chassis parts	W:1			W		W	–
Condition of bolts, nuts and fasteners		Q		Q		Q	–

Engine Oil

Oil Level Inspection

- If the engine is cold, start the engine and run it for several minutes at idle speed.
- Stop the engine, then wait several minutes until the oil settles.

NOTICE

Racing the engine before the oil reaches every part can cause engine seizure.

- Check the engine oil level through the oil level inspection window. With the motorcycle held level, the oil level should come up between the upper and lower level lines next to the oil level inspection window.

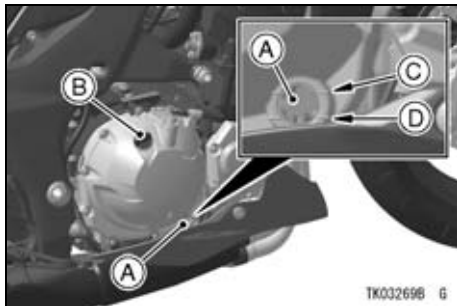

- A. Oil Level Inspection Window
- B. Oil Filler Cap
- C. Upper Level Line
- D. Lower Level Line

- If the oil level is too high, remove the excess oil through the oil filler opening using a syringe or some other suitable device.
- If the oil level is too low, add oil to reach the correct level. Use the same type and brand of oil that is already in the engine.

104 MAINTENANCE AND ADJUSTMENT

Oil and/or Oil Filter Change

- Warm up the engine thoroughly, and then stop it.
- Place an oil pan beneath the engine.
- Remove the engine oil drain bolt.

⚠ WARNING

Engine oil is a toxic substance. Dispose of used oil properly. Contact your local authorities for approved disposal methods or possible recycling.

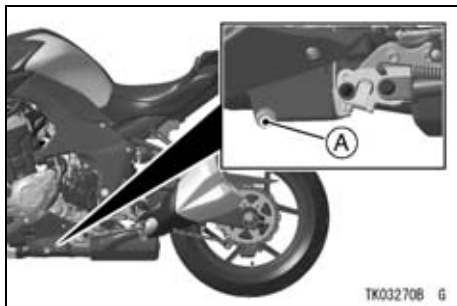

A. Engine Oil Drain Bolt

- Let the oil completely drain with the motorcycle perpendicular to the ground.
- If the oil filter is to be replaced, remove the oil filter cartridge and replace it with a new one.

NOTE

- *If a torque wrench or required Kawasaki special tool is not available, this item should be serviced by an authorized Kawasaki dealer.*

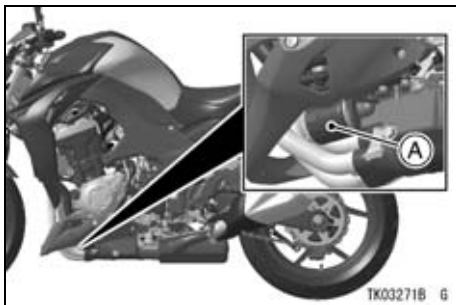

A. Oil Filter

- Apply a thin film of oil to the packing and tighten the cartridge to the specified torque.

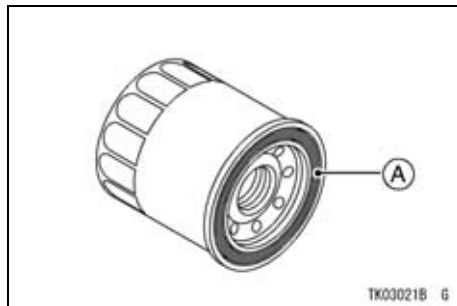

A. Packing

- Install the drain bolt with a new gasket. Tighten it to the specified torque.

NOTE

- *Replace the gasket with a new one.*

106 MAINTENANCE AND ADJUSTMENT

Tightening Torque

Cartridge:

17 N·m (1.7 kgf·m, 13 ft·lb)

Engine Oil Drain Bolt:

29 N·m (3.0 kgf·m, 21 ft·lb)

- Fill the engine up to the upper level line with a good quality engine oil specified in the table.

Recommended Engine Oil

Type:

API SG, SH, SJ, SL or SM with JASO MA, MA1 or MA2 rating

Viscosity:

SAE 10W-40

NOTE

- Do not add any chemical additive to the oil. Oils fulfilling the above requirements are fully formulated and provide adequate lubrication for both the engine and the clutch.

Engine Oil Capacity

3.2 L (3.4 US qt)

[when filter is not removed]

3.8 L (4.0 US qt)

[when filter is removed]

Although 10W-40 engine oil is the recommended oil for most conditions, the oil viscosity may need to be changed to accommodate atmospheric conditions in your riding area.

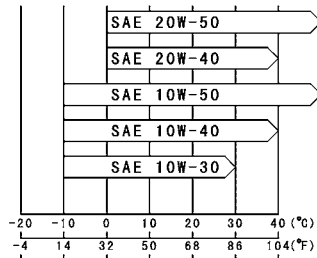

TK03023BZ2 C

- Start the engine.
- Check the oil level and oil leakage.

Coolant

Coolant Level Inspection

- Position the motorcycle so that it is perpendicular to the ground.
- Check the coolant level through the coolant level gauge on the reserve tank located to the behind of the engine. The coolant level should be between the F (Full) and L (Low) level lines.



- A. F (Full) Level Line
- B. L (Low) Level Line
- C. Reserve Tank

NOTE

- *Check the level when the engine is cold (room or atmospheric temperature).*
- If the amount of coolant is insufficient, add coolant into the reserve tank.

108 MAINTENANCE AND ADJUSTMENT

Coolant Filling

- Remove the cap from the reserve tank and add coolant through the filler opening to the F (Full) level line.

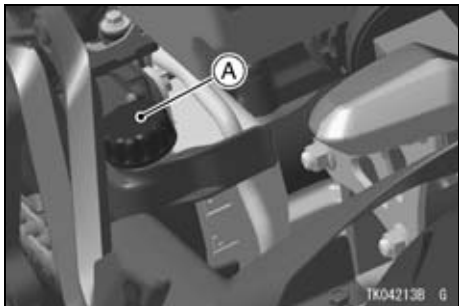

A. Reserve Tank Cap

NOTE

- *In an emergency you can add water alone to the coolant reserve tank,*

however it must be returned to the correct mixture ratio by the addition of antifreeze concentrate as soon as possible.

NOTICE

If coolant must be added often, or the reserve tank completely runs dry, there is probably leakage in the system. Have the cooling system inspected by your authorized Kawasaki dealer.

- Install the reserve tank cap.

Coolant Change

Have the coolant changed by an authorized Kawasaki dealer.

Coolant Requirement** WARNING**

Coolant containing corrosion inhibitors for aluminum engines and radiators include harmful chemicals for human body. Drinking coolant can result in serious injury or death. Use coolant in accordance with the instructions of the manufacturer.

Use a permanent type of antifreeze (soft water and ethylene glycol plus corrosion and rust inhibitor chemicals for aluminum engines and radiators) in the cooling system. On the mixture ratio of coolant, choose the suitable one referring to the relation between freezing point and strength directed on the container.

NOTICE

If hard water is used in the system, it causes scale accumulation in the water passages, and considerably reduces the efficiency of the cooling system.

NOTE

- *A permanent type of antifreeze is installed in the cooling system when shipped. It is mixed at 50% and has the freezing point of -35°C (-31°F).*

Air Cleaner

This motorcycle's air cleaner element consists of a wet paper filter. Cleaning and replacement of the air cleaner element should be done by an authorized Kawasaki dealer.

Oil Draining

- Inspect the transparent reservoir located to the left of the engine to see if any oil has run down.

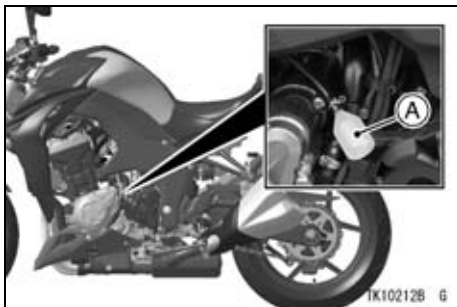

A. Transparent Reservoir

- If there is any oil in the transparent reservoir, remove the transparent reservoir from the lower end of the drain hose and drain the oil.

⚠ WARNING

Oil on tires will make them slippery and can cause an accident and injury. Be sure to install the reservoir in the drain hose after draining.

Throttle Control System

Throttle Grip

Throttle Grip Free Play Inspection

- Check that the throttle grip moves smoothly from full open to close, and the throttle closes quickly and completely by the return spring in all steering positions.
- If the throttle grip does not return properly, have the throttle control system checked by an authorized Kawasaki dealer.

- Check the throttle grip free play by turning back and forth.

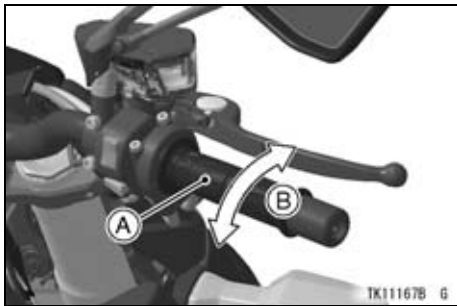

- A. Throttle Grip
- B. Throttle Grip Play

Throttle Grip Play

2 ~ 3 mm (0.08 ~ 0.12 in.)

- If there is improper play, adjust it.

Throttle Grip Free Play Adjustment

- Slide the boots.
- Loosen the locknuts at the upper ends of the throttle cables, and screw both throttle cable adjusters completely so as to give the throttle grip plenty of play.
- Turn out the decelerator cable adjuster until there is no play when the throttle grip is completely closed. Tighten the locknut.

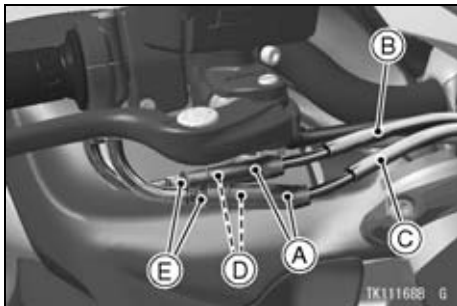

- A. Boots
- B. Decelerator Cable
- C. Accelerator Cable
- D. Adjusters
- E. Locknuts

- Turn out the accelerator cable adjuster until 2 ~ 3 mm (0.08 ~ 0.12 in.) of throttle grip play is obtained. Tighten the locknut.
- If the throttle cables cannot be adjusted with the adjuster at the upper

end of the throttle cable, further adjustment of the throttle cables should be done by an authorized Kawasaki dealer.

- With the engine idling, turn the handlebars to each side. If handlebars movement changes the idle speed, the throttle cables may be improperly adjusted or incorrectly routed, or they may be damaged. Be sure to correct any of these conditions before riding.

⚠ WARNING

Operation with improperly adjusted, incorrectly routed, or damaged cables could result in an unsafe riding condition. Be sure the control cables are adjusted and routed correctly, and are free from damage.

Idle Speed

Idle Speed Adjustment

- Start the engine, and warm it up thoroughly.
- Adjust the idle speed by turning the idle adjusting screw.

NOTE

- *While the engine is cold, the fast idle system automatically raises the engine idling speed.*

Idle Speed

1 050 ~ 1 150 r/min (rpm)



A. Idle Adjusting Screw

- Open and close the throttle a few times to make sure that the idle speed does not change. Readjust if necessary.
- With the engine idling, turn the handlebars to each side. If handlebars movement changes the idle speed, the throttle cables may be improperly adjusted or incorrectly routed, or they may be damaged. Be sure to correct any of these conditions before riding.

⚠ WARNING

Operation with damaged cables could result in an unsafe riding condition. Replace damaged control cables before operation.

Clutch

Clutch Operation Inspection

- Check that the clutch lever operates properly and that the inner cable slides smoothly. If there is any irregularity, have the clutch cable checked by an authorized Kawasaki dealer.
- Check the clutch lever play.

Clutch Lever Play

2 ~ 3 mm (0.08 ~ 0.12 in.)

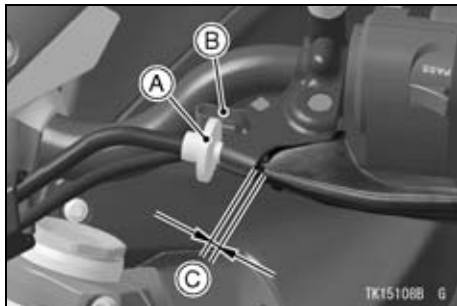

- A. Adjuster
- B. Stopper
- C. Clutch Lever Play

- If the play is incorrect, adjust the lever play as follows.

Clutch Cable Free Play Adjustment

- Turn the adjuster so that the clutch lever will have the specified free play.

⚠ WARNING

Excess clutch cable play could prevent clutch disengagement and cause a crash resulting in serious injury or death. When adjusting the clutch cable, be sure the upper end of the outer cable is fully seated in its fitting so that it doesn't slip into place later and create excessive cable play.

- If it cannot be done, have the clutch cable adjusted by an authorized Kawasaki dealer.

Drive Chain

Drive Chain Lubrication

Lubrication is necessary after riding through rain or on wet roads, or any time that the chain appears dry.

Use a lubricant for sealed chains to prevent deterioration of chain seals. If the chain is especially dirty, clean it using a cleaner for sealed chains following the instructions supplied by the chain cleaner manufacturer.

- Apply lubricant to the sides of the rollers so that it will penetrate to the rollers and bushings. Apply lubricant to the seals so that the seals will be coated with lubricant. Wipe off any excess lubricant.

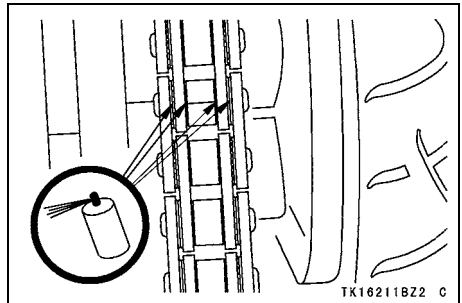

116 MAINTENANCE AND ADJUSTMENT

- Wipe off any lubricant that gets on the tire surface.

Drive Chain Slack Inspection

- Set the motorcycle up on its side stand.
- Clean the chain if it is dirty, and lubricate it if it appears dry.
- Rotate the rear wheel to find the position where the chain is tightest, and measure the maximum chain slack by pulling up and pushing down the chain midway between the engine sprocket and rear wheel sprocket.

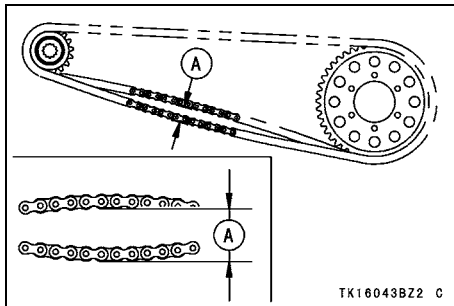

A. Chain Slack

- If the drive chain is too tight or too loose, adjust it so that the chain slack is within the standard value.

Drive Chain Slack

Standard: 20 ~ 30 mm (0.8 ~ 1.2 in.)

Drive Chain Slack Adjustment

- Loosen the chain adjuster clamp bolts on the left and right sides.

- Turn the chain adjuster with the Allen wrench until the drive chain has the correct amount of slack.
- Check that the notch on the swingarm and the mark on the chain adjuster are at the same position on the left and right sides.

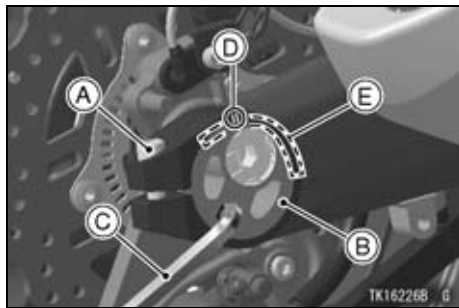

- A. Clamp Bolt
 B. Chain Adjuster
 C. Allen Wrench
 D. Notch
 E. Marks

⚠ WARNING

Misalignment of the wheel will result in abnormal wear, and may result in an unsafe riding condition. Align the rear wheel using the marks on the swingarm or measuring the distance between the center of the axle and swingarm pivot.

- Tighten the chain adjuster clamp bolts to the specified torque.

Tightening Torque

Chain Adjuster Clamp Bolts:
 64 N·m (6.5 kgf·m, 47 ft·lb)

NOTE

- *If a torque wrench is not available, this item should be serviced by an authorized Kawasaki dealer.*

118 MAINTENANCE AND ADJUSTMENT

- Rotate the wheel, measure the chain slack again at the tightest position, and readjust if necessary.

WARNING

A loose clamp bolts can lead to an accident resulting in serious injury or death. Tighten the clamp bolts to the proper torque.

- Check the rear brake (see Brakes section in this chapter).

Brakes

If you feel there is something wrong when applying the brakes, have the brake system checked by an authorized Kawasaki dealer immediately.

WARNING

Air in the brake lines diminish braking performance and can cause an accident resulting in injury or death. If the brake lever or pedal feels mushy when it is applied, there might be air in the brake lines or the brake may be defective. Have the brake checked immediately by an authorized Kawasaki dealer.

Brake Fluid Level Inspection

- With the brake fluid reservoirs held horizontal, the brake fluid level must be kept between the upper and lower level lines.

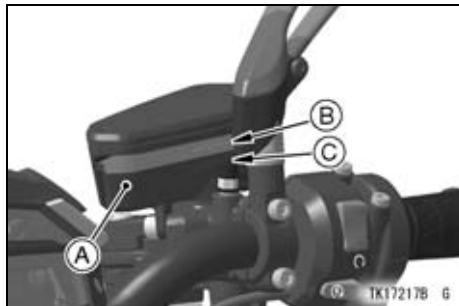

A. Front Brake Fluid Reservoir
B. Upper Level Line
C. Lower Level Line

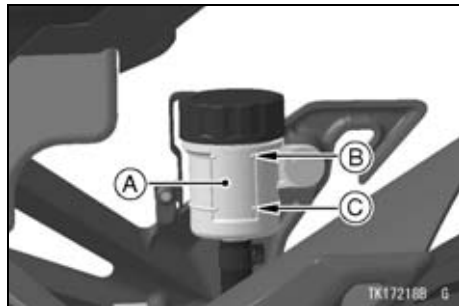

A. Rear Brake Fluid Reservoir
B. Upper Level Line
C. Lower Level Line

- If the fluid level is lower than the lower level line it may indicate that the fluid is leaking. In this case, have the brake system inspected by an authorized Kawasaki dealer.

120 MAINTENANCE AND ADJUSTMENT

Brake Pad Wear Inspection

Inspect the brakes for wear. For each front and rear disc brake caliper, if the thickness of either pad lining is less than 1 mm (0.04 in.), replace both pads in the caliper as a set. Pad replacement should be done by an authorized Kawasaki dealer.

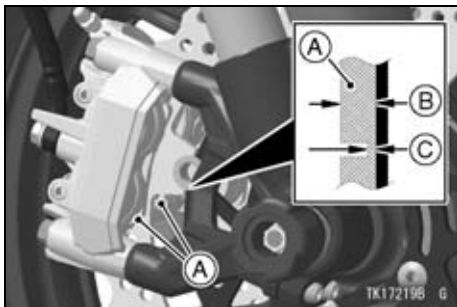

- A. Front Brake Pads
- B. Lining Thickness
- C. 1 mm (0.04 in.)

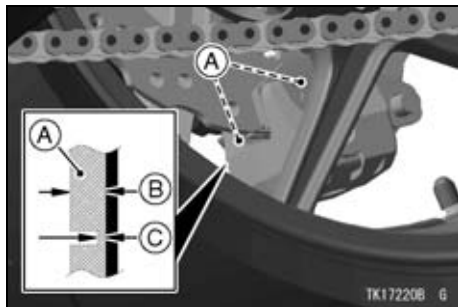

- A. Rear Brake Pads
- B. Lining Thickness
- C. 1 mm (0.04 in.)

Brake Light Switches

Brake Light Switch Inspection

- Turn the ignition switch on.
- The brake light should go on when the front brake is applied.

- If it does not, ask your authorized Kawasaki dealer to inspect the front brake light switch.
- Check the operation of the rear brake light switch by depressing the brake pedal. The brake light should go on after the proper pedal travel.

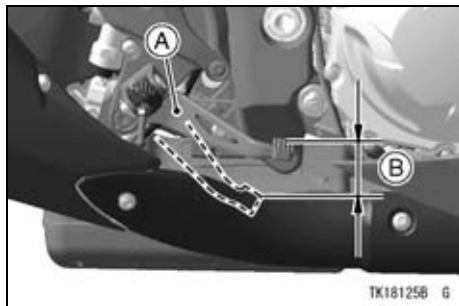

A. Brake Pedal
B. 10 mm (0.39 in.)

- If the light does not come on, adjust the rear brake light switch.

Brake Pedal Travel

10 mm (0.39 in.)

Brake Light Switch Adjustment

- Remove the right front footpeg bracket bolts.
- Pull the footpeg bracket a little bit outward.

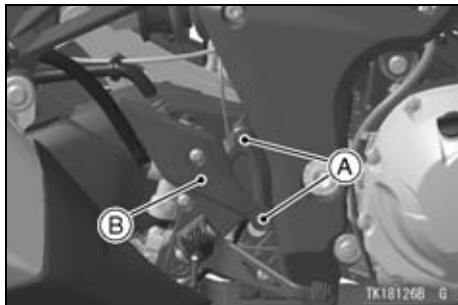

A. Bolts
B. Right Front Footpeg Bracket

122 MAINTENANCE AND ADJUSTMENT

- To adjust the rear brake light switch, move the switch up or down by turning the adjusting nut.

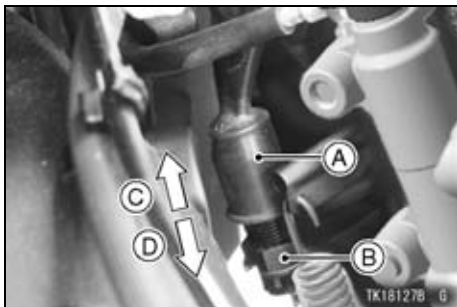

- A. Rear Brake Light Switch
- B. Adjusting Nut
- C. Lights sooner
- D. Lights later

NOTICE

To avoid damaging the electrical connections inside the switch, be sure that the switch body does not turn during adjustment.

- Reinstall the right front footpeg bracket.

Tightening Torque

Front Footpeg Bracket Bolts:
25 N·m (2.5 kgf·m, 18 ft·lb)

NOTE

- *If a torque wrench is not available, this item should be serviced by an authorized Kawasaki dealer.*

Suspension System

Front Fork

Spring Preload Adjustment

The adjuster is located at the top of left front fork leg.

Standard

6 1/4 turns in

In from the fully seated position (turned fully counterclockwise).

- Turn the adjuster clockwise to increase spring preload and stiffen the suspension.

- Turn the adjuster counterclockwise to decrease spring preload and soften the suspension.

NOTICE

Do not turn the adjuster beyond the fully seated position or the adjusting mechanism may be damaged.

NOTE

- *The spring preload adjuster can be turned with the allen wrench or suitable tool.*

124 MAINTENANCE AND ADJUSTMENT

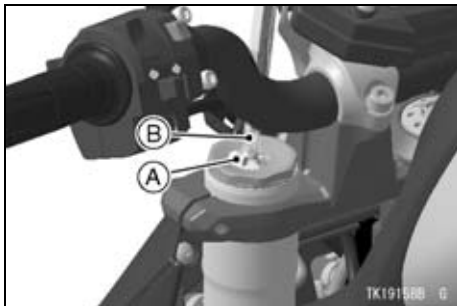

- A. Spring Preload Adjuster
B. Allen Wrench

Rebound Damping Force Adjustment

The adjuster is located at the top of the right front fork leg.

Standard

2 1/2 turns out

Out from the fully seated position (turned fully clockwise).

- Turn the adjuster clockwise with a standard tip screwdriver to increase damping force.
- Turn the adjuster counterclockwise to decrease damping force.

NOTICE

Do not turn the adjuster beyond the fully seated position or the adjusting mechanism may be damaged.

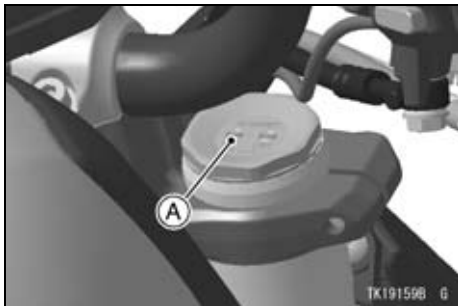

A. Rebound Damping Force Adjuster

Compression Damping Force Adjuster

The adjuster is located at the top of the right front fork leg.

Standard

4 1/2 turns out

Out from the fully seated position (turned fully clockwise).

- Turn the adjuster clockwise with a standard tip screwdriver to increase damping force.
- Turn the adjuster counterclockwise to decrease damping force.

NOTICE

Do not turn the adjuster beyond the fully seated position or the adjusting mechanism may be damaged.

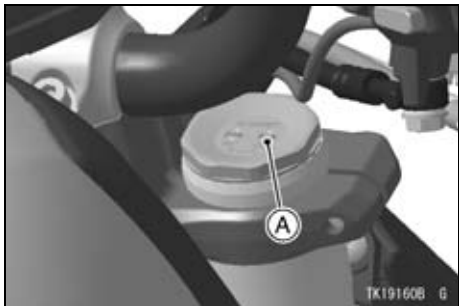

A. Compression Damping Force Adjuster

Rear Shock Absorber

Spring Preload Adjustment

The spring adjusting nut on the rear shock absorber can be adjusted.

If the spring action feels too soft or too stiff, have it adjusted by an authorized Kawasaki dealer.

Rebound Damping Force Adjustment

The adjuster is located at the lower end of the rear shock absorber.

Standard

3/4 turns out

Out from the fully seated position (turned fully clockwise).

- Turn the adjuster clockwise with a standard tip screwdriver to increase damping force.
- Turn the adjuster counterclockwise to decrease damping force.

NOTICE

Do not turn the adjuster beyond the fully seated position or the adjusting mechanism may be damaged.

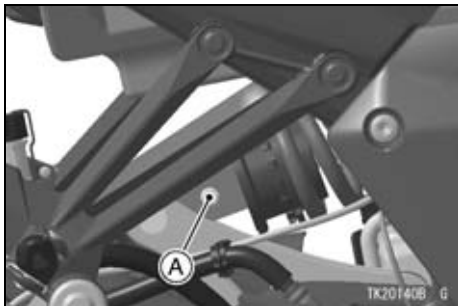

A. Rebound Damping Force Adjuster

Setting Tables

Front Fork Spring Preload Setting

	Softest setting limit	Standard	Hardest setting limit
Adjuster Position	0*	6 1/4 turns in**	20 turns in**
Spring Action	Weak	←→	Strong
Setting	Soft	←→	Hard
Load	Light	←→	Heavy
Road	Good	←→	Bad
Speed	Low	←→	High

*: This position is the fully seated position (turned fully counterclockwise).

** : In from the fully seated position (turned fully counterclockwise). This adjustment range may not exactly match the number shown in the table due to small tolerance of production.

Front Fork Damping Force Settings

		Softest setting limit	Standard	Hardest setting limit
Adjuster Position:	Rebound	5 1/2 turns out**	2 1/2 turns out**	0*
	Compression	7 turns out**	4 1/2 turns out**	0*
Damping Force		Weak	←→	Strong
Setting		Soft	←→	Hard
Load		Light	←→	Heavy
Road		Good	←→	Bad
Speed		Low	←→	High

*: This position is the fully seated position (turned fully clockwise).

** : Out from the fully seated position (turned fully clockwise). This adjustment range may not exactly match the number shown in the table due to small tolerance of production.

130 MAINTENANCE AND ADJUSTMENT

Rear Shock Absorber Damping Force Settings

		Softest setting limit	Standard	Hardest setting limit
Adjuster Position:	Rebound	2 1/2 turns out**	3/4 turns out**	0*
Damping Force		Weak	←→	Strong
Setting		Soft	←→	Hard
Load		Light	←→	Heavy
Road		Good	←→	Bad
Speed		Low	←→	High

*: This position is the fully seated position (turned fully clockwise).

** : Out from the fully seated position (turned fully clockwise). This adjustment range may not exactly match the number shown in the table due to small tolerance of production.

Wheels

Tire Pressure Inspection

- Remove the air valve cap.
- Check the tire pressure often, using an accurate gauge.
- Make sure to install the air valve cap securely.

NOTE

- *Measure the tire pressure when the tires are cold (that is, when the motorcycle has not been ridden more than a mile during the past 3 hours).*
- *Tire pressure is affected by changes in ambient temperature and altitude, and so the tire pressure should be checked and adjusted when your riding involves wide variations in temperature or altitude.*

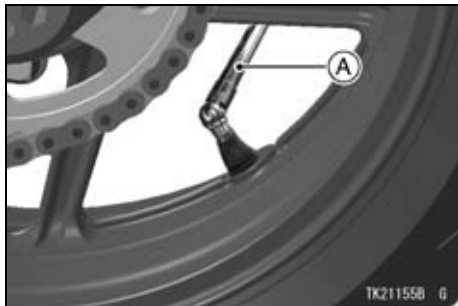

A. Tire Pressure Gauge

Tire Air Pressure (when cold)

Front	250 kPa (2.50 kgf/cm ² , 36 psi)
Rear	290 kPa (2.90 kgf/cm ² , 42 psi)

Tire Wear, Damage

As the tire tread wears down, the tire becomes more susceptible to puncture and failure. An accepted estimate is that 90% of all tire failures occur during the last 10% of tread life (90% worn).

132 MAINTENANCE AND ADJUSTMENT

So it is false economy and unsafe to use the tires until they are bald.

Tire Wear Inspection

- Measure the depth of the tread with a depth gauge, and replace any tire that has worn down to the minimum allowable tread depth.

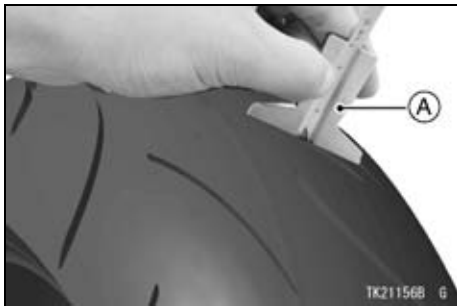

A. Tire Depth Gauge

Minimum Tread Depth

Front	—	1 mm (0.04 in.)
Rear	Under 130 km/h (80 mph)	2 mm (0.08 in.)
	Over 130 km/h (80 mph)	3 mm (0.12 in.)

- Visually inspect the tire for cracks and cuts, replacing the tire in case of bad damage. Swelling or high spots indicate internal damage, requiring tire replacement.

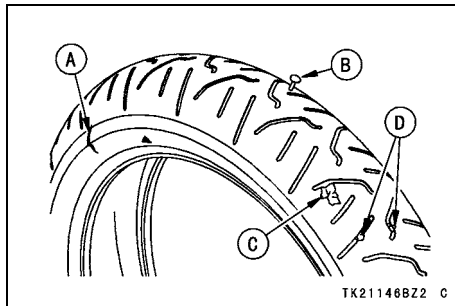

- A. Crack or Cut
- B. Nail
- C. Swelling or High Spot
- D. Stone

- Remove any imbedded stones or other foreign particles from the tread.

NOTE

- *Have the wheel balance inspected whenever a new tire is installed.*

⚠ WARNING

Tires that have been punctured and repaired do not have the same capabilities as undamaged tires and can suddenly fail, causing an accident resulting in serious injury or death. Replace damaged tires as soon as possible. To ensure safe handling and stability, use only the recommended standard tires for replacement, inflated to the standard pressure. If it is necessary to ride on a repaired tire, do not exceed 100 km/h (60 mph) until the tire is replaced.

NOTE

- *Most countries may have their own regulations requiring a minimum tire tread depth; be sure to follow them.*

134 MAINTENANCE AND ADJUSTMENT

- *When operating on public roadways, keep maximum speed under traffic law limits.*

Standard Tire (Tubeless)

Front	Make, Type: DUNLOP, D214F T Size: 120/70ZR17 M/C (58W)
Rear	Make, Type: DUNLOP, D214 T Size: 190/50ZR17 M/C (73W)

WARNING

Mixing tire brands and types can adversely affect handling and cause an accident resulting in injury or death. Always use the same manufacturer's tires on both front and rear wheels.

WARNING

New tires are slippery and may cause loss of control and injury. A break-in period of 160 km (100 miles) is necessary to establish normal tire traction. During break-in, avoid sudden and maximum braking and acceleration, and hard cornering.

Battery

The battery installed in this motorcycle is a sealed type, so it is not necessary to check the battery electrolyte level or add distilled water.

NOTICE

Never remove the sealing strip, or the battery can be damaged. Do not install a conventional battery in this motorcycle, or the electrical system cannot work properly.

Make	Yuasa Battery
Type	YT12A-BS

Battery Maintenance

It is the owner's responsibility to keep the battery fully charged. Failure to do so can lead to battery failure and leave you stranded.

If you are riding your vehicle infrequently, inspect the battery voltage weekly using a voltmeter. If it drops below 12.8 volts, the battery should be charged using an appropriate charger (check with your Kawasaki dealer).

If you will not be using the motorcycle for longer than two weeks, the battery should be charged using an appropriate charger. Do not use an automotive-type quick charger that may overcharge the battery and damage it.

NOTE

- *Leaving the battery connected causes the electrical components (clock etc) to make the battery discharged, resulting the over discharge of the battery. In this case, the repair or replacement of the battery is not included in the warranty. If you do not drive for four weeks or more, disconnect the battery from the vehicle.*

Kawasaki-recommended chargers are:

Battery Mate 150-9
 OptiMate 4
 Yuasa MB-2040/2060
 Christie C10122S

136 MAINTENANCE AND ADJUSTMENT

If the above chargers are not available, use equivalent one.

For more details, ask your Kawasaki dealer.

Battery Charging

- Charge the battery following the instructions of your battery charger.
- The charger will keep the battery fully charged until you are ready to re-install the battery in the motorcycle (see Battery Installation).

DANGER

Battery acid generates hydrogen gas which is flammable and explosive under certain conditions. It is present within a battery at all times, even in a discharged condition. Keep all flames and sparks (cigarettes) away from the battery. Wear eye protection when working with a battery. In the event of battery acid contact with skin, eyes, or clothing, wash the affected areas immediately with water for at least five minutes. Seek medical attention.

Battery Removal

- Make sure the ignition switch is turned off.

- Remove the rider's seat. Refer to the Seats section in the GENERAL INFORMATION chapter.
- Slide the red cap from the positive (+) terminal.
- Disconnect the cables from the battery, first from the (-) terminal and then the (+) terminal.

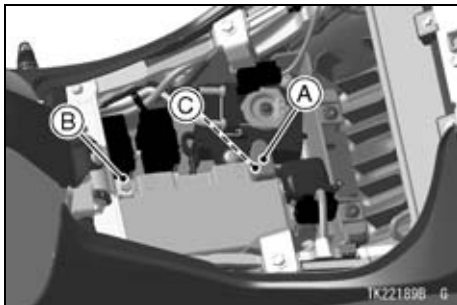

- A. Red Cap
 B. (-) Terminal
 C. (+) Terminal

- Take the battery out of the battery case.
- Clean the battery using a solution of baking soda and water. Be sure that the cable connections are clean.

Battery Installation

- Place the battery on the battery case.
- Connect the (+) cable to the (+) terminal, and then connect the (-) cable to the (-) terminal.

NOTICE

Installing the (-) cable to the (+) terminal of the battery or the (+) cable to the (-) terminal of the battery can seriously damage the electrical system.

- Put a light coat of grease on the terminals to prevent corrosion.

138 MAINTENANCE AND ADJUSTMENT

- Cover the (+) terminal with the red cap.
- Install the removed parts.

Headlight

Headlight aiming should be done by an authorized Kawasaki dealer.

WARNING

The cooling fins at the rear of headlight become very hot during normal operation and can cause serious burns. To prevent burns, never touch the cooling fins at the rear of headlight while the engine is running or shortly after it has been stopped.

Horizontal Adjustment

The headlight beam is adjustable horizontally. If not properly adjusted horizontally, the beam will point to one side rather than straight ahead.

- Turn the horizontal adjuster in or out until the beam points straight ahead.

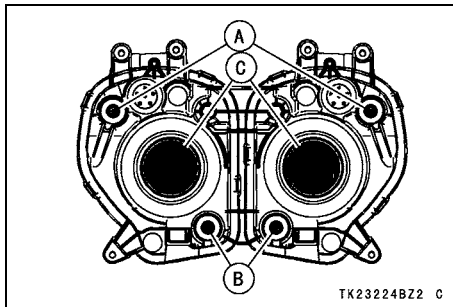

- A. Horizontal Adjusters
- B. Vertical Adjusters
- C. Cooling Fins (Heat Sink)

Vertical Adjustment

The headlight beam is adjustable vertically. If adjusted too low, neither low nor high beam will illuminate the road far enough ahead. If adjusted too high, the high beam will fail to illuminate the road close ahead, and the low beam will blind oncoming drivers.

- Turn the vertical adjuster in or out to adjust the headlight vertically.

NOTE

- *On high beam, the brightest point should be slightly below horizontal with the motorcycle on its wheels and the rider seated. Adjust the headlight to the proper angle according to local regulations.*



Fuses

Fuses are arranged in the fuse boxes located under the rider's seat. The main fuse is located under the rider's seat. If a fuse fails during operation, inspect the electrical system to determine the cause, and then replace it with a new fuse of proper amperage.

140 MAINTENANCE AND ADJUSTMENT

If the fuse fails repeatedly, there is something wrong with the electrical system. Have the motorcycle checked by an authorized Kawasaki dealer.

The main fuse removal should be done by an authorized Kawasaki dealer.

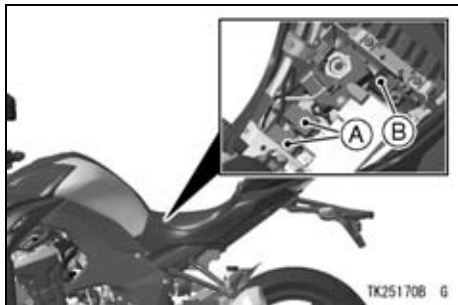

- A. Fuse Boxes
- B. Main Fuse

⚠ WARNING

Substituting fuses can cause wiring to overheat, catch fire and/or fail. Do not use any substitute for the standard fuse. Replace the blown fuse with a new one of the correct capacity, as specified on the fuse boxes and main fuse.

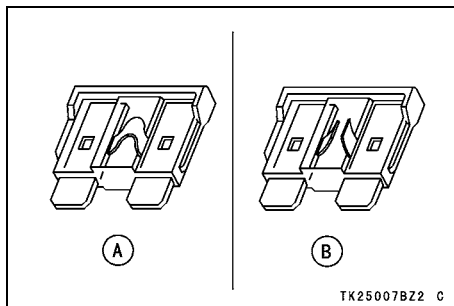

- A. Normal
- B. Failed

General Lubrication

Lubricate the points shown below, with either engine oil or regular grease, in accordance with the Periodic Maintenance Chart or whenever the vehicle has been operated under wet or rainy conditions.

Before lubricating each part, clean off any rusty spots with rust remover and wipe off any grease, oil, dirt, or grime.

Apply motor oil to the following pivots

- Side Stand
- Clutch Lever
- Front Brake Lever
- Rear Brake Pedal

Lubricate the following cables with a pressure cable luber

- (K) Clutch Inner Cable
- (K) Throttle Inner Cables

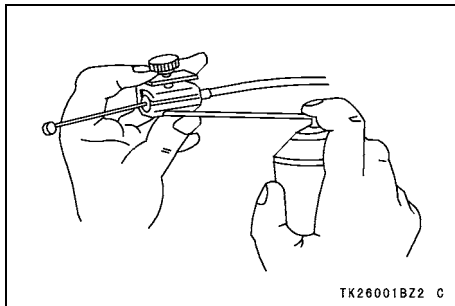

Apply grease to the following points

- (K) Clutch Inner Cable Upper End
- (K) Throttle Inner Cable Upper Ends

(K): Should be serviced by an authorized Kawasaki dealer.

NOTE

- *After connecting the cables, adjust them.*

Cleaning Your Motorcycle

General Precautions

Frequent and proper care of your Kawasaki motorcycle will enhance its appearance, optimize overall performance, and extend its useful life. Covering your motorcycle with a high quality, breathable motorcycle cover will help protect its finish from harmful UV rays, pollutants, and reduce the amount of dust reaching its surfaces.

WARNING

Build-up of debris or flammable material in and around the vehicle chassis, engine, and exhaust can cause mechanical problems and increase the risk of fire.

When operating the vehicle in conditions that allow debris or flammable material to collect in and around the vehicle, inspect the engine, electrical component and exhaust areas frequently. If debris or flammable materials have collected, park the vehicle outside and stop the engine. Allow the engine to cool, then remove any collected debris. Do not park or store the vehicle in an enclosed space prior to inspecting for build-up of debris or flammable materials.

- Be sure the engine and exhaust are cool before washing.
- Avoid applying degreaser to seals, brake pads, and tires.
- Avoid all harsh chemicals, solvents, detergents, and household cleaning products such as ammonia-based window cleaners.
- Gasoline, brake fluid, and coolant will damage the finish of painted and plastic surfaces: wash them off immediately.
- Avoid wire brushes, steel wool, and all other abrasive pads or brushes.
- Use care when washing the headlight lens and other plastic parts as they can easily be scratched.
- Avoid using pressure washers; water can penetrate seals and electrical components and damage your motorcycle.

- Avoid spraying water in delicate areas such as in air intakes, fuel system, brake components, electrical components, muffler outlets, and fuel tank openings.

Washing Your Motorcycle

- Rinse your bike with cold water from a garden hose to remove any loose dirt.
- Mix a mild neutral detergent (designed for motorcycles or automobiles) and water in a bucket. Use a soft cloth or sponge to wash your motorcycle. If needed, use a mild degreaser to remove any oil or grease build up.
- After washing, rinse your motorcycle thoroughly with clean water to remove any residue (residue from the

144 MAINTENANCE AND ADJUSTMENT

detergent can damage parts of your motorcycle).

- Use a soft cloth to dry your motorcycle. As you dry, inspect your motorcycle for chips and scratches. Do not let the water air dry as this can damage the painted surfaces.
- Start the engine and let it idle for several minutes. The heat from the engine will help dry moist areas.
- Carefully ride your motorcycle at a slow speed and apply the brakes several times. This helps dry the brakes and restores them to normal operating performance.
- Lubricate the drive chain to prevent rusting.

NOTE

- *After riding in an area where the roads are salted or near the ocean, immediately wash your motorcycle with cold water. Do not use warm water as it accelerates the chemical reaction of the salt. After drying, apply a corrosion protection spray on all metal and chrome surfaces to prevent corrosion.*
- *Condensation may form on the inside of the headlight lens after riding in the rain, washing the motorcycle or humid weather. To remove the moisture, start the engine and turn on the headlight. Gradually the condensation on the inside of the lens will clear off.*

Radiator

Clean off any obstructions with a stream of low-pressure water.

NOTICE

Using high-pressure water, as from a car wash facility, could damage the radiator fins and impair the radiator's effectiveness. Do not obstruct or deflect airflow through the radiator by installing unauthorized accessories in front of the radiator or behind the cooling fan. Interference with the radiator airflow can lead to overheating and consequent engine damage.

Semi-gloss Finish

To clean the semi-gloss finish;

- When washing the motorcycle, always use a mild neutral detergent and water.
- The semi-gloss finish effect may be lost when the finish is excessively rubbed.
- If any doubt, consult an authorized Kawasaki dealer.

Other Plastic Parts

After washing use a soft cloth to gently dry plastic parts. When dry, treat the headlight lens and other non-painted plastic parts with an approved plastic cleaner/polisher product.

NOTICE

Plastic parts may deteriorate and break if they come in contact with chemical substances or household cleaning products such as gasoline, brake fluid, window cleaners, thread-locking agents, or other harsh chemicals. If a plastic part comes in contact with any harsh chemical substance, wash it off immediately with water and a mild neutral detergent, and then inspect for damage. Avoid using abrasive pads or brushes to clean plastic parts, as they will damage the part's finish.

Chrome and Aluminum

Chrome and uncoated aluminum parts can be treated with a chrome/aluminum polish. Coated aluminum

should be washed with a mild neutral detergent and finished with a spray polish. Aluminum wheels, both painted and unpainted can be cleaned with special non-acid based wheel spray cleaners.

Leather, Vinyl, and Rubber

If your motorcycle has leather accessories, special care must be taken. Use a leather cleaner/treatment to clean and care for leather accessories. Washing leather parts with detergent and water will damage them, shortening their life.

Vinyl parts should be washed with the rest of the motorcycle, then treated with a vinyl treatment.

The sidewalls of tires and other rubber components should be treated with a rubber protectant to help prolong their useful life.

 **WARNING**

Rubber protectants can be slippery and, if used on the tread area, cause loss of traction resulting in accident causing injury or death. Do not apply rubber protectant to any tread area.

Storage

Preparation for Storage

- Clean the entire vehicle thoroughly.
- Run the engine for about five minutes to warm the oil, shut it off, and drain the engine oil.

WARNING

Engine oil is a toxic substance. Dispose of used oil properly. Contact your local authorities for approved disposal methods or possible recycling.

- Put in fresh engine oil.
- Empty the fuel from the fuel tank by the pump or siphon.

 **WARNING**

Gasoline is extremely flammable and can be explosive under certain conditions, creating the potential for serious burns. Turn the ignition key off. Do not smoke. Make sure the area is well ventilated and free from any source of flame or sparks; this includes any appliance with a pilot light. Gasoline is a toxic substance. Dispose of gasoline properly. Contact your local authorities for approved disposal methods.

- Empty the fuel system by running the engine at idle speed until the engine stalls (If left in for a long time, the fuel will break down and could clog the fuel system).

 **WARNING**

An air/oil mist may be forcibly ejected from the spark plug holes and could get into your eyes. Do not lean over the engine when performing this procedure. If you do get oil in your eyes, wash them immediately with liberal amounts of clean, fresh water and consult a physician as soon as possible.

- Reduce tire pressure by about 20%.
- Set the motorcycle on a box or stand so that both wheels are raised off the ground. (If this cannot be done, put boards under the front and rear wheels to keep dampness away from the tire rubber.)

- Spray oil on all unpainted metal surfaces to prevent rusting. Avoid getting oil on rubber parts or in the brakes.
- Lubricate the drive chain and all the cables.
- Remove the battery, and store it where it will not be exposed to direct sunlight, moisture, or freezing temperatures. During storage it should be given a slow charge (one ampere or less) about once a month. Keep the battery well charged especially during cold weather.
- Tie plastic bags over the mufflers to prevent moisture from entering.
- Put a cover over the motorcycle to keep dust and dirt from collecting on it.

Preparation after Storage

- Remove the plastic bags from the mufflers.
- Install the battery in the motorcycle and charge the battery if necessary.
- Fill the fuel tank with fuel.
- Check all the points listed in the Daily Checks section.
- Lubricate the pivots, bolts, and nuts.

Troubleshooting Guide

Engine Does Not Start

Starter Motor Won't Turn

- Engine stop switch off
- Transmission not in neutral
- Fuse blown
- Battery cables do not make good electrical contact with battery terminals
- Battery discharged

Engine Cranks, But Won't Start

- No fuel in tank
- Fuel line clogged
- Fuel broken down
- Engine flooded
- Spark plugs not in good contact
- Spark plugs fouled or wet
- Incorrect spark plug gap
- Incorrect valve clearance
- No first turning the ignition switch to "OFF" when the motorcycle falls down.

Engine Stalls

Just When Shifting Into 1st Gear

- Side stand has been left down
- Clutch does not properly disengage

While Riding

- No fuel in tank
- Fuel tank air vent is obstructed
- Overheating
- Battery discharged

OWNER SATISFACTION

(For Products Sold in Australia Only)

Your satisfaction is important to your authorized Kawasaki dealer and to Kawasaki Motors Pty., Ltd. If you have a problem concerning warranty or service, please take the following action:

Contact the owner and/or service manager of your authorized Kawasaki dealer. Fully explain your problem and ask for assistance in resolving the situation. The OWNER of the dealership is an independent business person and is concerned with your satisfaction and your future business. For this reason the owner is in the best position to assist you. Also, all warranty and service matters are handled and resolved through the authorized Kawasaki dealer network.

If you are unsatisfied after working with your Kawasaki dealer and feel you still require further assistance, WRITE to the address below. Please be certain to provide the model, product identification number, mileage or hours of use, accessories, dates that events occurred and what action has been taken by both you and your dealer. Include the name and address of the dealership. To assist us in resolving your inquiry, please include copies of related receipts and any other pertinent information including the names of the dealership personnel with whom you have been working in the resolution of your problem.

Upon receipt of your WRITTEN correspondence we will contact the dealership and work with them in resolving your problem.

In order to provide a permanent record, all warranty and service resolutions take place only through WRITTEN correspondence.

Please send your correspondence to:

Customer Relations:

Technical Services Department
KAWASAKI MOTORS Pty., Ltd.
LOCKED BAG 802,
ERMINGTON. NSW. 1700.
A.C.N. 002 840 315.
E-mail: info@Kawasaki.com.au

Environmental Protection

To help preserve the environment, properly discard used batteries, tires, oils and fluids, or other vehicle components that you might dispose of in the future. Consult your authorized Kawasaki dealer or local environmental waste agency for their proper disposal procedure. This also applies to disposal of the entire vehicle at the end of its life.

MAINTENANCE RECORD

Owner Name.....

Address

Phone Number

Engine Number

Vehicle Number.....

Key Code

Selling Dealer Name

Phone Number

Warranty Start Date

Note: Keep this information and a spare key in a secure location.

Date	Odometer Reading	Maintenance Performed	Dealer Name	Dealer Address

ZR1000FF/GF



Kawasaki Heavy Industries, Ltd. Motorcycle & Engine Company

Printed in Japan

GB