

# Ninja ZX-10R Ninja ZX-10R ABS

Motorcycle

---

# OWNER'S MANUAL

---

 Read this manual carefully. It contains safety information.

**Kawasaki**

# Quick Reference Guide

This Quick Reference Guide will assist you in finding the information you're looking for.

**GENERAL INFORMATION**

**HOW TO RIDE THE MOTORCYCLE**

**SAFE OPERATION**

**MAINTENANCE AND ADJUSTMENT**

**STORAGE**

**TROUBLESHOOTING GUIDE**

A Table of Contents is included after the Foreword.

Whenever you see the symbols shown below, heed their instructions! Always follow safe operating and maintenance practices.

 **DANGER**

**DANGER** indicates a hazardous situation which, if not avoided, will result in death or serious injury.

 **WARNING**

**WARNING** indicates a hazardous situation which, if not avoided, could result in death or serious injury.

**NOTICE**

**NOTICE** is used to address practices not related to personal injury.

**NOTE**

○ *NOTE* indicates information that may help or guide you in the operation or service of the vehicle.

 **WARNING**

Engine exhaust, some of its constituents, and certain vehicle components contain or emit chemicals known to the State of California to cause cancer and birth defects or other reproductive harm.

***NOTICE***

**THIS PRODUCT HAS BEEN MANUFACTURED FOR USE IN A REASONABLE AND PRUDENT MANNER BY A QUALIFIED OPERATOR AND AS A VEHICLE ONLY.**

## FOREWORD

Congratulations on your purchase of a new Kawasaki motorcycle. Your new motorcycle is the product of Kawasaki's advanced engineering, exhaustive testing, and continuous striving for superior reliability, safety and performance.

**Please read this Owner's Manual carefully before riding** so that you will be thoroughly familiar with the proper operation of your motorcycle's controls, its features, capabilities, and limitations. This manual offers many safe riding tips, but its purpose is not to provide instruction in all the techniques and skills required to ride a motorcycle safely. Kawasaki strongly recommends that all operators of this vehicle enroll in a motorcycle rider training program to attain awareness of the mental and physical requirements necessary for safe motorcycle operation.

To ensure a long, trouble-free life for your motorcycle, give it the proper care and maintenance described in this manual. For those who would like more detailed information on their Kawasaki Motorcycle, a Service Manual is available for purchase from any authorized Kawasaki motorcycle dealer. The Service Manual contains detailed disassembly and maintenance information. Those who plan to do their own work should, of course, be competent mechanics and possess the special tools described in the Service Manual.

Keep this Owner's Manual aboard your motorcycle at all times so that you can refer to it whenever you need information.

This manual should be considered a permanent part of the motorcycle and should remain with the motorcycle when it is sold.

All rights reserved. No part of this publication may be reproduced without our prior written permission.

This publication includes the latest information available at the time of printing. However, there may be minor differences between the actual product and illustrations and text in this manual.

All products are subject to change without prior notice or obligation.

**KAWASAKI HEAVY INDUSTRIES, LTD.**  
**Motorcycle & Engine Company**

---

## TABLE OF CONTENTS

---

<b>SPECIFICATIONS</b> .....	9	Right Handlebar Switches.....	63
<b>SERIAL NUMBER LOCATIONS</b> .....	13	Engine Stop Switch .....	63
<b>LOCATION OF PARTS</b> .....	14	Starter Button .....	63
<b>LOADING AND ACCESSORIES</b>		START/STOP Switch (for Stop	
<b>INFORMATION</b> .....	17	Watch).....	64
<b>GENERAL INFORMATION</b> .....	20	Brake Lever Adjuster.....	64
Meter Instruments .....	20	Fuel Tank Cap .....	65
Tachometer .....	22	Fuel Tank .....	66
Instrument Display Brightness		Fuel Requirement .....	68
Control .....	26	Side Stand .....	71
Multifunction Meter .....	28	Seats.....	72
Warning/Indicator Lights .....	48	Tool Kit .....	75
Keys .....	58	Air Cleaner Intake .....	75
Ignition Switch/Steering Lock .....	60	Front Footpeg Position.....	76
Left Handlebar Switches .....	61	<b>BREAK-IN</b> .....	77
Dimmer Switch .....	62	<b>HOW TO RIDE THE MOTORCYCLE</b> .	79
Turn Signal Switch.....	62	Starting the Engine .....	79
Horn Button .....	62	Jump Starting.....	82
LAP/Passing Button.....	62	Moving Off.....	85
Power/S-KTRC Button.....	62	Shifting Gears .....	86

Braking .....	88	Evaporative Emission Control	
Kawasaki Intelligent anti-lock		System (California model only).....	141
Brake System (KIBS, For models		Valve Clearance .....	142
equipped with KIBS) .....	89	Kawasaki Clean Air System .....	143
Stopping the Engine .....	92	Exhaust Device .....	144
Stopping the Motorcycle in an		Air Cleaner .....	145
Emergency .....	92	Throttle Control System .....	150
Parking .....	93	Engine Vacuum Synchronization ....	153
Catalytic Converter.....	95	Idle Speed .....	153
Sport-Kawasaki TRaction Control		Clutch .....	154
(S-KTRC).....	96	Drive Chain .....	156
Power mode .....	100	Brakes .....	165
<b>SAFE OPERATION</b> .....	103	Brake Light Switches.....	169
Safe Riding Technique .....	103	Electronic Steering Damper .....	171
Daily Checks .....	106	Front Fork.....	172
Additional Considerations for High		Rear Shock Absorber.....	178
Speed Operation .....	109	Wheels .....	185
<b>MAINTENANCE AND ADJUSTMENT</b>	111	Battery.....	190
Periodic Maintenance Chart.....	115	Headlight Beam.....	196
Engine Oil .....	128	Fuses .....	199
Cooling System .....	133	General Lubrication.....	202
Spark Plugs.....	140	Cleaning Your Motorcycle .....	203
		Bolt and Nut Tightening.....	210



<b>STORAGE</b> .....	213
<b>TROUBLESHOOTING GUIDE</b> .....	216
<b>YOUR WARRANTY/OWNER</b>	
<b>SATISFACTION</b> .....	217

<b>REPORTING SAFETY DEFECTS</b> .....	223
<b>ENVIRONMENTAL PROTECTION</b> .....	224
<b>MAINTENANCE RECORD</b> .....	225
<b>LOCATION OF LABELS</b> .....	229

---

## SPECIFICATIONS

---

### PERFORMANCE

Minimum Turning Radius 3.4 m (134 in.)

### DIMENSIONS

Overall Length 2 075 mm (81.7 in.)

Overall Width 715 mm (28.1 in.)

Overall Height 1 115 mm (43.9 in.)

Wheelbase 1 425 mm (56.1 in.)

Road Clearance 135 mm (5.3 in.)

Curb Mass (ZX1000J) 198 kg (437 lb)

(ZX1000K) 201 kg (443 lb)

### ENGINE

Type DOHC, 4-cylinder, 4-stroke, liquid-cooled

Displacement 998 cm<sup>3</sup> (60.9 cu in.)

Bore × Stroke 76.0 × 55.0 mm (3.0 × 2.2 in.)

Compression Ratio 13.0:1

## 10 SPECIFICATIONS

Starting System	Electric starter
Cylinder Numbering Method	Left to right, 1-2-3-4
Firing Order	1-2-4-3
Fuel System	FI (Fuel Injection)
Ignition System	Battery and coil (transistorized ignition)
Ignition Timing (Electronically advanced)	10° BTDC @1 100 r/min (rpm) ~ 42.5° BTDC @10 500 r/min (rpm)
Spark Plugs	NGK CR9EIA-9
Lubrication System	Forced lubrication (wet sump)
Engine Oil:	
Type	API SG, SH, SJ, SL or SM with JASO MA, MA1 or MA2
Viscosity	SAE 10W-40
Capacity	3.7 L (3.9 US qt)
Coolant Capacity	2.6 L (2.7 US qt)

## TRANSMISSION

Transmission Type	6-speed, constant mesh, return shift
-------------------	--------------------------------------

Clutch Type	Wet, multi disc
Driving System	Chain drive
Primary Reduction Ratio	1.681 (79/47)
Final Reduction Ratio	2.294 (39/17)
Overall Drive Ratio	5.197 @Top gear
Gear Ratio:	
1st	2.600 (39/15)
2nd	2.053 (39/19)
3rd	1.737 (33/19)
4th	1.571 (33/21)
5th	1.444 (26/18)
6th	1.348 (31/23)

**FRAME**

Caster	25°
Trail	107 mm (4.2 in.)

## 12 SPECIFICATIONS

### Tire Size:

Front 120/70ZR17 M/C (58W)

Rear 190/55ZR17 M/C (75W)

### Rim Size:

Front J17M/C × MT3.50

Rear J17M/C × MT6.00

Fuel Tank Capacity 17 L (4.5 US gal)

## ELECTRICAL EQUIPMENT

Battery (ZX1000J) 12 V 6 Ah (10 HR)  
(ZX1000K) 12 V 8.6 Ah (10 HR)

### Headlight:

High beam 12 V 55 W + 55 W

Low beam 12 V 55 W

Tail/Brake Light LED

Even if one of LED (Light Emitting Diode) tail/brake lights does not go on, consult with an authorized Kawasaki dealer.

Specifications are subject to change without notice.

---

## SERIAL NUMBER LOCATIONS

---

The engine and frame serial numbers are used to register the motorcycle. They are the only means of identifying your particular machine from others of the same model type. These serial numbers may be needed by your dealer when ordering parts. In the event of theft, the investigating authorities will require both numbers as well as the model type and any peculiar features of your machine that can help them identify it.

### Frame No.

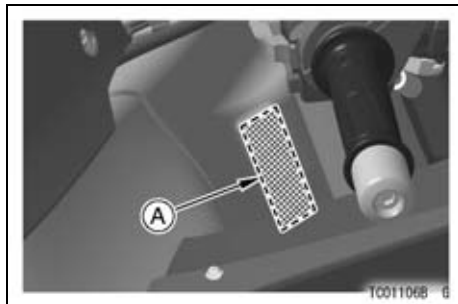

A. Frame Number

### Engine No.

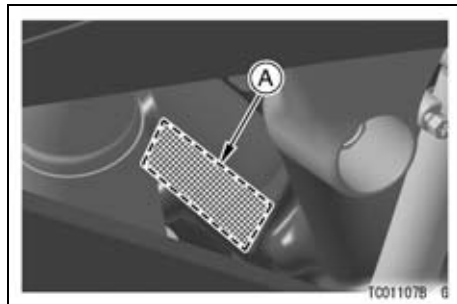

A. Engine Number

## LOCATION OF PARTS

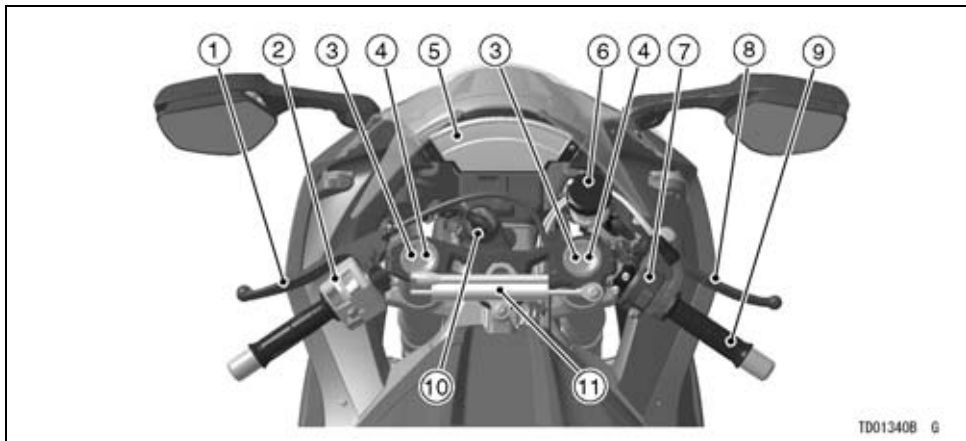

TD01340B G

1. Clutch Lever
2. Left Handlebar Switches
3. Rebound Damping Force Adjuster (Front Fork)
4. Compression damping force adjuster (Front Fork)
5. Meter Instruments

6. Brake Fluid Reservoir (Front)
7. Right Handlebar Switches
8. Front Brake Lever
9. Throttle Grip
10. Ignition Switch/Steering Lock
11. Electronic Steering Damper

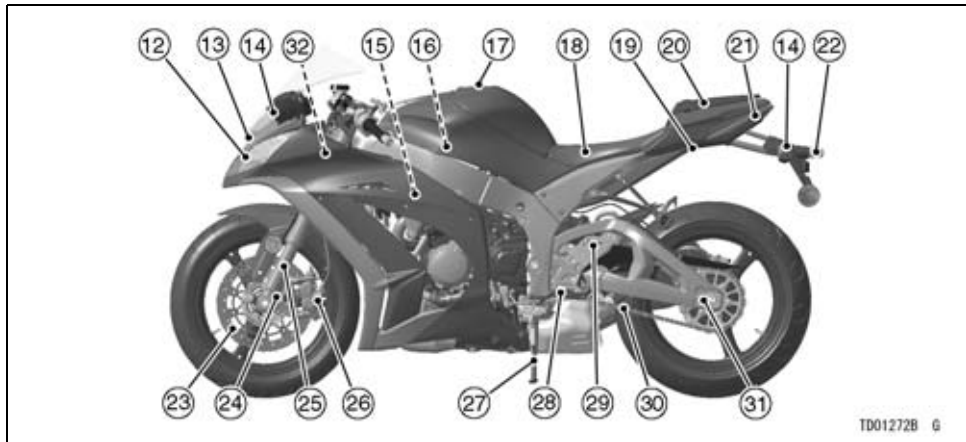

TD01272B G

- 12. Headlight
- 13. Air Cleaner Intake
- 14. Turn Signal Lights
- 15. Spark Plugs
- 16. Air Cleaner
- 17. Fuel Tank
- 18. Rider's Seat
- 19. Seat Lock

- 20. Passenger's Seat
- 21. Tail/Brake Light
- 22. License Plate Light
- 23. Brake Disc
- 24. Spring Preload Adjuster
- 25. Front Fork
- 26. Brake Caliper

- 27. Side Stand
- 28. Shift Pedal
- 29. Compression damping force adjusters
- 30. Drive Chain
- 31. Chain Adjuster
- 32. Fuse Box



## 16 LOCATION OF PARTS

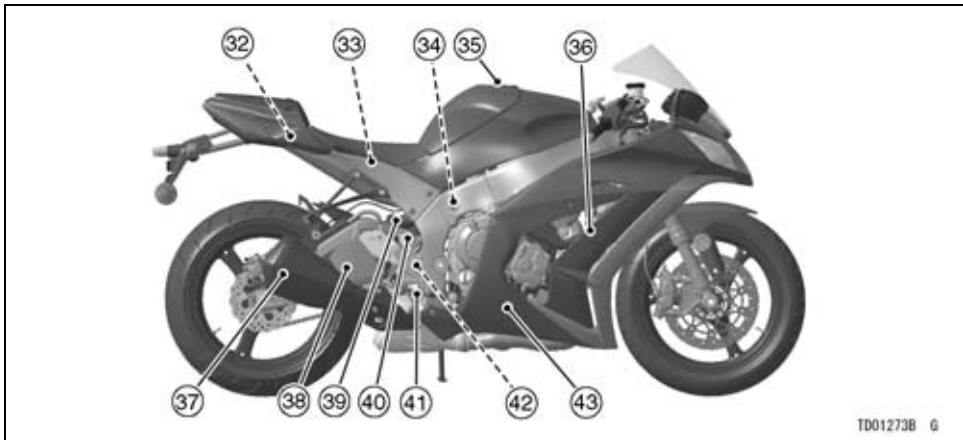

TD01273B G

**32. Fuse Boxes**

**33. Battery**

**34. Rebound damping force adjuster**

**35. Fuel Tank Cap**

**36. Coolant Reserve Tank**

**37. Muffler**

**38. Swingarm**

**39. Rear Shock Absorber**

**40. Brake Fluid Reservoir (Rear)**

**41. Rear Brake Pedal**

**42. Rear Brake Light Switch**

**43. Oil Level Inspection Window**

---

**LOADING AND ACCESSORIES INFORMATION**

---

 **WARNING**

**Incorrect loading, improper installation or use of accessories, or modification of your motorcycle may result in an unsafe riding condition. Before you ride the motorcycle, make sure it is not overloaded and that you have followed these instructions.**

With the exception of genuine Kawasaki Parts and Accessories, Kawasaki has no control over the design or application of accessories. In some cases, improper installation or use of accessories, or motorcycle modification, will void the motorcycle warranty, can negatively affect performance, and can even be illegal.

In selecting and using accessories, and in loading the motorcycle, you are personally responsible for your own safety and the safety of other persons involved.

**NOTE**

○ *Kawasaki Parts and Accessories have been specially designed for use on Kawasaki motorcycles. We strongly recommend that all parts and accessories you add to your motorcycle be genuine Kawasaki components.*

Because a motorcycle is sensitive to changes in weight and aerodynamic forces, you must take extreme care in carrying cargo, passengers and/or in

## 18 LOADING AND ACCESSORIES INFORMATION

fitting additional accessories. The following general guidelines have been prepared to assist you in making your determinations.

1. Any passenger should be thoroughly familiar with motorcycle operation. The passenger can affect control of the motorcycle by improper positioning during cornering and sudden movements. It is important that the passenger sits still while the motorcycle is in motion and not interfere with the operation of the motorcycle. Do not carry animals on your motorcycle.
2. You should instruct any passenger before riding to keep his or her feet on the passenger footpegs and hold on to the operator or seat strap. Do not carry a passenger unless he or she is tall enough to reach the footpegs and footpegs are provided.
3. All baggage should be carried as low as possible to reduce the effect on the motorcycle center of gravity. Baggage weight should also be distributed equally on both sides of the motorcycle. Avoid carrying baggage that extends beyond the rear of the motorcycle.
4. Baggage should be securely attached. Make sure that the baggage will not move around while you are riding. Recheck baggage security as often as possible (not while the motorcycle is in motion) and adjust as necessary.
5. Do not carry heavy or bulky items on a luggage rack. They are designed for light items, and overloading can affect handling due to changes in weight distribution and aerodynamic forces.

6. Do not install accessories or carry baggage that impairs the performance of the motorcycle. Make sure that you have not adversely affected any lighting components, road clearance, banking capability (i.e., lean angle), control operation, wheel travel, front fork movement, or any other aspects of the motorcycle's operation.
7. Weight attached to the handlebar or front fork will increase the mass of the steering assembly and can result in an unsafe riding condition.
8. Fairings, windshields, backrests, and other large items have the capability of adversely affecting stability and handling of the motorcycle, not only due to their weight, but also due to the aerodynamic force acting on these surfaces while the motorcycle is in operation. Poorly designed or installed items can result in an unsafe riding condition.
9. This motorcycle is not intended to be equipped with a sidecar or to be used to tow any trailers or other vehicles. Kawasaki does not manufacture sidecars or trailers for motorcycles and cannot predict the effects of such accessories on handling or stability, but can only warn that the effects can be adverse and that Kawasaki cannot assume responsibility for the results of such unintended use of the motorcycle. Furthermore, any adverse effects on motorcycle components caused by the use of such accessories will not be remedied under warranty.

**Maximum Load**

Weight of rider, passenger, baggage, and accessories must not exceed 180 kg (397 lb).

## Meter Instruments

- A. Upper Button
- B. Lower Button
- C. Tachometer (with Shift-Up Indicator)
- D. Red Zone
- E. Ambient Brightness Sensor
- F. Turn Signal Indicator Light
- G. Warning Indicator Light (Red)
- H. Neutral Indicator Light
- I. Multifunction Meter
- J. High Beam Indicator Light
- K. Warning Indicator Light (Yellow)
- L. Fuel Level Warning Indicator Light

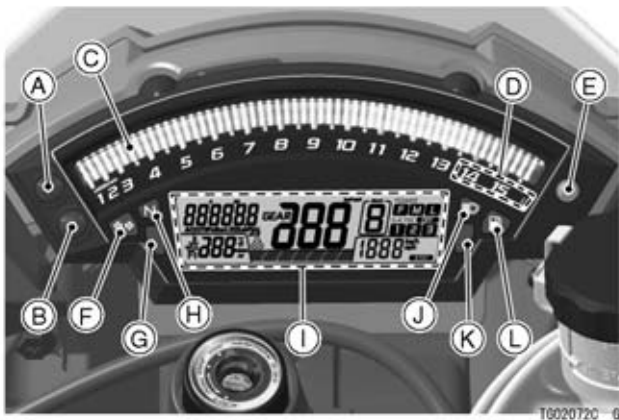

**(For models equipped with KIBS\*)**

- A. Upper Button
- B. Lower Button
- C. Tachometer (with Shift-Up Indicator)
- D. Red Zone
- E. Ambient Brightness Sensor
- F. Turn Signal Indicator Light
- G. Warning Indicator Light (Red)
- H. Neutral Indicator Light
- I. Multifunction Meter
- J. High Beam Indicator Light
- K. Warning Indicator Light (Yellow)
- L. ABS Indicator Light



KIBS\*: Kawasaki Intelligent anti-lock Brake System

## 22 GENERAL INFORMATION

### Tachometer

The tachometer shows the engine speed in revolutions per minute (r/min, rpm).

On the right side of the tachometer face is a portion called the “red zone”. Engine r/min (rpm) in the red zone is above maximum recommended engine speed and is also above the range for good performance.

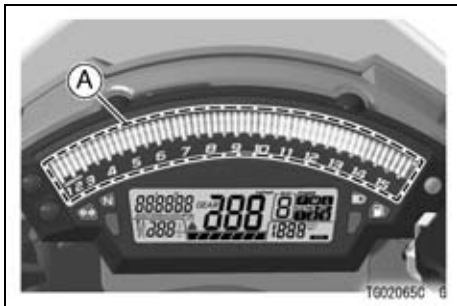

A. Tachometer

When the ignition switch is turned to “ON”, the tachometer LED segments blink for a few seconds then go off. If the tachometer does not operate correctly, have it checked by an authorized Kawasaki dealer.

### **NOTICE**

**Engine r/min (rpm) should not be allowed to enter the red zone; operation in the red zone will overstress the engine and may cause serious engine damage.**

### Shift-up Indicator -

The shift-up indicator can be set to tachometer LED segments blink at the desired engine speeds. This indicator is used to inform the rider when it is time to shift to the next higher gear.

This shift-up indicator is used to inform to the rider when it is time to shift to the next higher gear with blinking the tachometer LED segments.

The shift-up indicator can be used in closed course competition. Do not use the shift-up indicator during everyday riding.

### Shift-up Indicator Setting -

The shift-up indicator has three modes, light off, fast blinking or slow blinking. The shift-up indicator timing can be adjusted between 9 500 r/min (rpm) and 14 000 r/min (rpm).

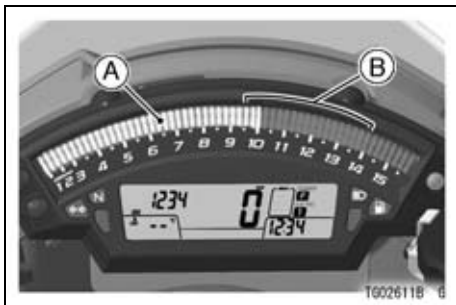

**A. Tachometer**

**B. Adjustable Range**

To select a shift-up indicator mode or adjust the shift-up engine speed setting in the tachometer, do the followings while the engine is at a stop.



## 24 GENERAL INFORMATION

- Turn the ignition switch to “ON”.
- Push the upper and lower buttons simultaneously for more than 2 seconds. The previous shift-up engine speed setting will be displayed in the tachometer.

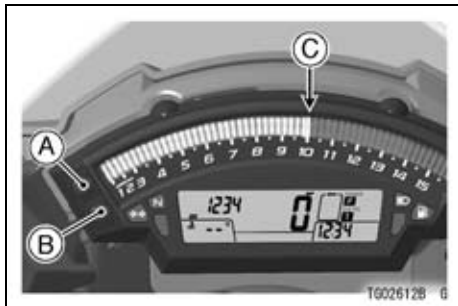

- A. Upper Button**
- B. Lower Button**
- C. Shift-up Engine Speed**

- To change the shift-up indicator mode, push the upper button and the illumination of tachometer segment

will shift between Light ON (shift-up indicator deactivates), Fast Blinking and Slow Blinking. The shift-up engine speed can only be adjusted when the segments are blinking.

- To adjust the shift-up engine speed, push the lower button and the shift-up engine speed timing advances in 250 r/min (rpm) increments up to 14 000 r/min (rpm). Once the reading reaches at 14 000 r/min (rpm) while advancing, it returns to 9 500 r/min (rpm) and begins advancing.
- To complete the adjustment, push the upper and lower buttons simultaneously for more than 2 seconds. The tachometer now operates normally.
- To adjust the tachometer brightness, push the upper button for more than 2 seconds (See Instrument Display Brightness Adjustment).

 **WARNING**

Failing to properly observe the road ahead increases the chance of an accident. Do not concentrate on the shift-up indicator by taking your eyes off the road, observe using peripheral vision. When shifting down to a lower gear, do not shift at such a high speed that the engine r/min (rpm) jumps excessively. Not only can this cause engine damage, but the rear wheel may skid and cause an accident. Downshifting should be done below 5 000 r/min (rpm) for each gear.

**NOTE**

- *Pushing and holding the lower button advances the shift-up engine speed continuously.*
- *The data are maintained even if the battery is disconnected.*

**NOTICE**

**Engine r/min (rpm) should not be allowed to enter the red zone; operation in the red zone will overstress the engine and may cause serious engine damage.**

### Instrument Display Brightness Control

The brightness of the tachometer LED segments and illumination of the multifunction meter are controlled automatically depending on the ambient brightness.

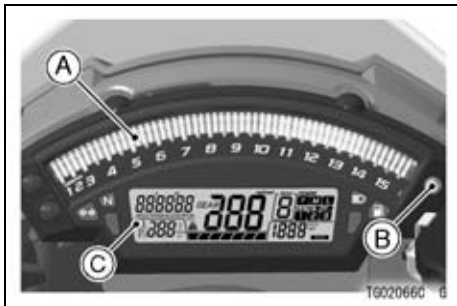

- A. Tachometer
- B. Ambient Brightness Sensor
- C. Multifunction Meter

### NOTE

- *Be careful not to cover the ambient brightness sensor on the meter instrument while riding the motorcycle.*

### Instrument Display Brightness Adjustment -

The brightness of the instrument display can be adjusted manually in three levels while the motorcycle is at a stop.

- While the shift-up indicator setting mode, push the upper button for more than 2 seconds. All tachometer LED segments are goes on.
- Push the lower button to select the preferred brightness level.
- To complete the adjustment, push the upper and lower buttons simultaneously for more than 2 seconds. The tachometer now operates normally.

- To return to the shift up indicator setting mode, push the upper button for more than 2 seconds.

## 28 GENERAL INFORMATION

### Multifunction Meter

#### A. Multifunction Display

- Odometer
- Trip Meters
- Current Mileage
- Average Mileage
- Fuel consumption
- Stop Watch

#### B. Speedometer

#### C. Gear Position Indicator

#### D. Power Mode Indicator

#### E. S-KTRC Mode Indicator

#### F. Warning Symbols

#### G. Lap Counter/Coolant / Intake Air Temperature Meter

- Lap Counter
- Coolant Temperature
- Intake Air Temperature



- H. Economical Riding Indicator
- I. S-KTRC Level Indicator
- J. Clock
- K. KIBS Indicator (For the models equipped with KIBS)
- L. Electronic Steering Damper Indicator
- M. Fuel Level Warning Symbol (For the models equipped with KIBS)



## 30 GENERAL INFORMATION

### Speedometer -

The speedometer shows the speed of the vehicle in digital values.

### Unit Setting -

The unit setting in the meter instrument can be changed according to local regulations. Make sure the unit setting is correctly displayed before riding.

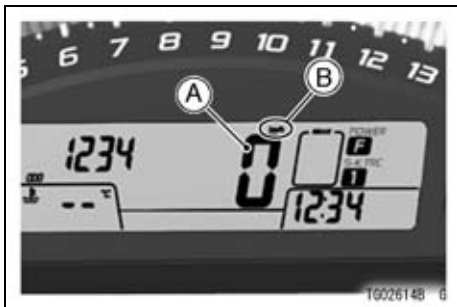

A. Speedometer

B. Meter Display Units

## NOTE

○ Do not operate the motorcycle with wrong unit (mph or km/h) of the speedometer.

To change the meter display units in the meter instrument as follows:

- Display the odometer in the multi-function display.
- The display unit modes shifts by pushing the lower button while the upper button pushed in.

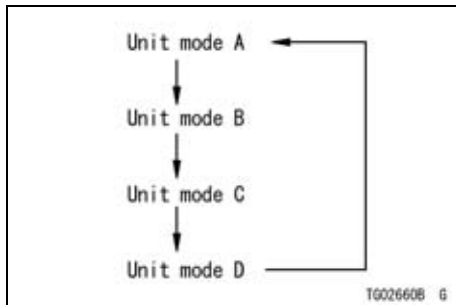

**Unit modes:**

Unit mode	Speed	Distance	Temperature	Volume	Mileage
A	km/h	km	°C	L	km/L
B	mph	mile	°F	GAL US	MPG US
C	mph	mile	°C	GAL UK	MPG UK
D	km/h	km	°C	L	L/100 km

T602635B S

**Multifunction Display -**

The multifunction display indicates the following modes.

- Odometer
- Trip meter A
- Trip meter B
- Current Mileage
- Average Mileage
- Fuel Consumption
- Stop Watch

These display modes can be shifted by pushing the upper button.

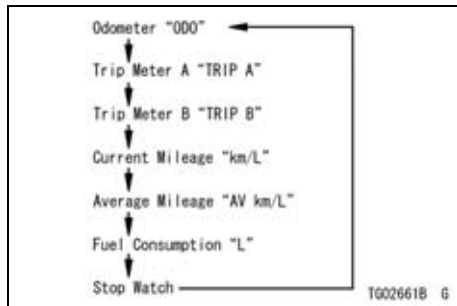
**NOTE**

- *The "FUEL" warning can be indicated if the fuel level is too low.*
- *For safety, do not operate the instrument buttons while riding the motorcycle.*
- *The multifunction display is displayed in the unit depending on the*



## 32 GENERAL INFORMATION

*unit mode setting, refer to the “Unit Setting” item in this section.*

### **Odometer -**

The odometer shows the total distance in kilometers or miles that the vehicle has run. If the odometer is displayed, the “ODO” is displayed on the multifunction display. This meter cannot be reset.

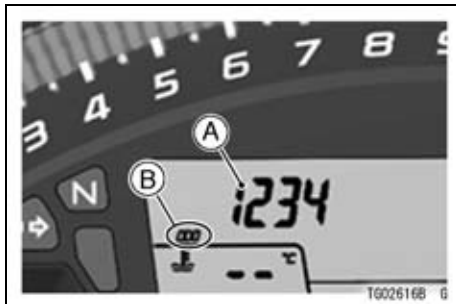

A. Odometer  
B. “ODO”

### **NOTE**

- *The data are maintained even if the battery is disconnected.*
- *When the figures come to 999999, the display is stopped and locked.*

### **Trip Meters -**

The trip meter has two meters which distinguished between the “TRIP A” and “TRIP B”. The trip meter shows the distance in kilometers or miles traveled since it was last reset to zero.

**TRIP A:** 0.0 ~ 9999.9

**TRIP B:** 0.0 ~ 9999.9

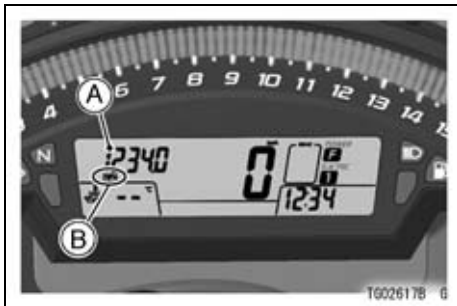

A. Trip Meter

B. "TRIP A"

To reset the trip meter:

- Push the upper button to select the trip meter A or B.

- Push the lower button and hold it in.

## NOTE

- *The data is maintained by the back up power if the ignition switch is turned "OFF".*
- *When the trip meter reaches 9999.9 while riding, the meter resets to 0.0 and continues counting.*
- *When the battery is disconnected, the meter display resets to 0.0.*
- *The display unit modes can be changed, refer to the "Unit Setting" item in this section.*

## 34 GENERAL INFORMATION

### Current Mileage -

This display mode shows the current mileage by numerical value. The current mileage display is renewed every 4 seconds.

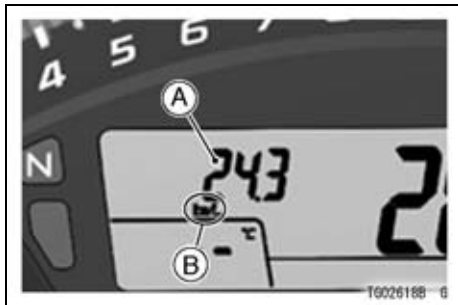

A. Current Mileage  
B. "km/L"

### NOTE

- *The display unit modes can be changed, refer to the "Unit Setting" item in this section.*

- *The numerical value shows "– .–" until 4 seconds have passed and the speedometer rises to above 0 km/h (0 mph).*

### Average Mileage -

This display mode shows the average mileage by numerical value counted from the start of measuring to present time.



A. Average Mileage  
B. "AV km/L"

- While the average mileage is displayed, push the lower button and hold it in until the average mileage values resets to “--.-”.

### NOTE

- *The data is maintained by back up power if the ignition switch is turned “OFF”.*
- *The display unit modes can be changed, refer to the “Unit Setting” item in this section.*
- *When the battery is disconnected, the average mileage resets to “--.-”.*
- *After resetting the average mileage, the numerical value is not displayed until 5 mL (0.2 US oz.) of fuel has been used and 100 m (328 ft) has been traveled.*

### Fuel Consumption -

This display mode shows the fuel consumption in Liter or Gallon by numerical value counted from the start of measuring to present time.



- A. Fuel Consumption
- B. “L”

- While the fuel consumption is displayed, push the lower button and hold it in until the fuel consumption values resets to “0.0”.

## 36 GENERAL INFORMATION

### NOTE

- *The data is maintained by back up power if the ignition switch is turned “OFF”.*
- *The display unit modes can be changed, refer to the “Unit Setting” item in this section.*
- *When the battery is disconnected, the fuel consumption resets to “0.0”.*

### Stop Watch -

The stop watch can be used in closed course competition.

The stop watch is operated as follows:

- Push the upper button to display the stop watch.

- To start the stop watch, push the “START/STOP” switch on the right handlebar switch to the left.

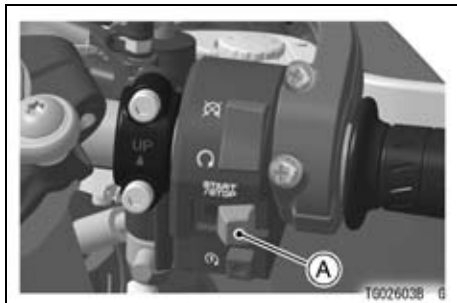

A. “START/STOP” Switch

- The stop watch starts timing laps.

- After each lap, push the LAP/passing button on the left handlebar switch.

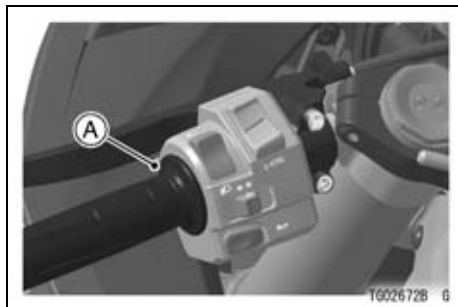

**A. LAP/Passing Button**

- The stop watch starts timing the next lap and the previous lap time and the lap number are displayed for ten seconds.

## NOTE

- *The LAP/passing button does not function while the headlight goes on with high beam.*

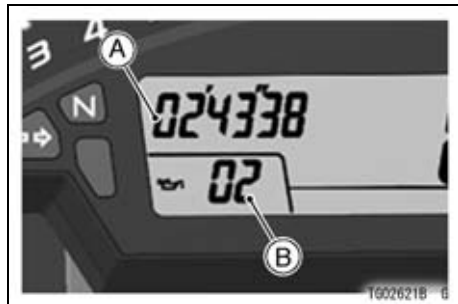

- A. Lap Time**
- B. Lap Number**

- To stop the stop watch, push the “START/STOP” switch to the left.

## 38 GENERAL INFORMATION

- To display each measured lap time and lap number, push the lower button momentarily when the stop watch is stopped.
- When the lap number is displayed “--”, the displayed time is the total time of all timed laps.
- To reset the stop watch and erase all lap numbers and times, push the lower button and hold it in until the stop watch resets to zero.

### NOTE

- *If the ignition switch is turned “OFF” while the lap time/number is displayed, the total time of all timed laps is displayed when the ignition switch is turned “ON”.*
- *If the stop watch mode is shifted to other modes during displaying*

*the lap time/number, the lap time or total time of all timed laps are displayed when the stop watch mode is reslected.*

- *If the ignition switch is turned “OFF” while counting the lap time, current lap time is cleared. However, previous lap times are stored and previous lap time or total time of all timed laps are displayed when the ignition switch is turned “ON”.*
- *When the battery is disconnected, the stop watch is resets to zero.*
- *If the “FUEL” warning is displayed in the multifunction display, the coolant temperature or the intake air temperature is displayed instead of lap number. However the time measurement is not interrupted.*

- If the coolant temperature rises above 115°C (239°F) with the lap number displayed, the lap number display in the Lap Counter/Coolant/Intake Air Temperature Meter automatically shifts to the coolant temperature meter.
- The lap time can be stored for a maximum of 99 times.

### Lap Counter/Coolant/Intake Air Temperature Meter -

This meter shows the coolant temperature, the intake air temperature or the lap number. The lap number is displayed in the stop watch mode, refer to the “Stop Watch” item in this section.



A. Lap Counter/Coolant / Intake Air Temperature Meter



## 40 GENERAL INFORMATION

- The coolant temperature meter and intake air temperature meter modes can be shifted alternately by pushing the lower button.

### NOTE

- *For safety reasons, do not operate the instrument buttons while riding the motorcycle.*
- *The meter is displayed in the unit depending on the unit mode setting, refer to the “Unit Setting” item in this section.*
- *The coolant temperature meter and intake air temperature meter cannot be shifted while displaying the stop watch or adjusting the clock.*
- *When the battery is reconnected, the meter display is set to coolant temperature meter by default.*

### Coolant Temperature Meter -

The coolant temperature gauge indicates temperature of the engine coolant. The “” symbol is displayed if the coolant temperature meter is selected.

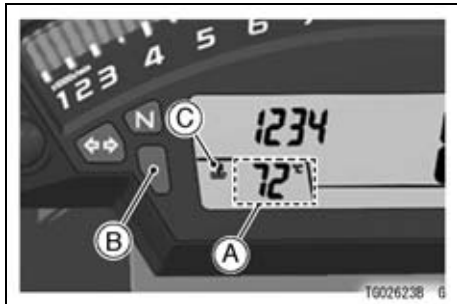

- A. Coolant Temperature Meter
- B. Warning Indicator Light (Red)
- C. “” Symbol

- If the coolant temperature is below 40°C (104°F), “--” is displayed.

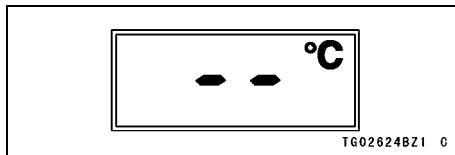

When the coolant temperature rises to above 40°C (104°F), the numerical value of the coolant temperature at the present state is displayed.



- If the coolant temperature rises to above 115°C (239°F) and below 120°C (248°F), the numerical value of the current coolant temperature starts blinking and the red warning indicator light also goes on. This warns the operator that the coolant temperature is high.

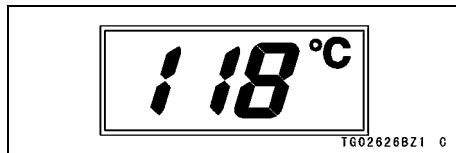

## 42 GENERAL INFORMATION

If the coolant temperature rises to above 120°C (248°F), “HI” is displayed and starts blinking and the red warning indicator light also goes on. This warns the operator that the coolant temperature is too high. Stop the engine and check the coolant level in the reserve tank after the engine cools down.

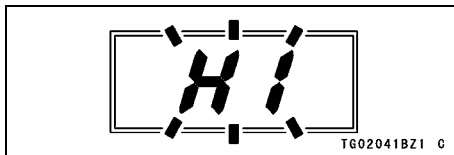

### **NOTICE**

Do not let the engine continue running when the coolant temperature shows “HI”. Prolonged engine operation will result in severe engine damage from overheating.

### **Intake Air Temperature Meter -**

Intake air temperature meter indicates temperature of the air in the air cleaner case.

The “Intake Air” is displayed if the intake air temperature meter is selected.

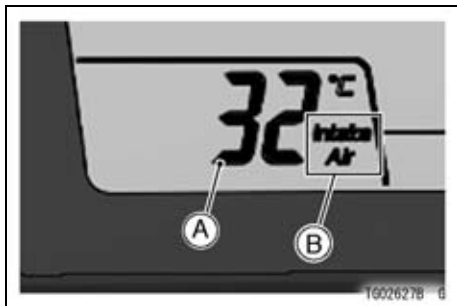

- A. Intake Air Temperature Meter
- B. “Intake Air”

**NOTE**

- *The intake air temperature meter shift to the coolant temperature meter automatically if the coolant temperature rises to above 115°C (239°F). In this case, the meter cannot be shifted to the intake air temperature meter until the red warning indicator light goes off.*

**Gear Position Indicator -**

The gear position indicator shows the corresponding gear positions where the transmission is shifted.

For example, when the transmission is in 6th gear, “6” is displayed.



A. Gear Position Indicator (Normal mode)

**NOTE**

- *If the gear position is in the neutral position, the gear position is disappears and the neutral indicator light goes on.*

**Race Mode Display -**

This mode gives priority to reading the gear position rather than the speedometer reading.

## 44 GENERAL INFORMATION

The gear position indicator can be displayed at the position of the speedometer on the normal mode. Also the speedometer is displayed instead of the clock on the normal mode.

This mode can be used in closed course competition. Do not use this mode during everyday riding.

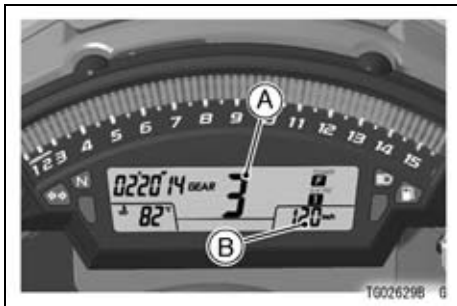

**A. Gear Position Indicator (Race Mode Display)**

**B. Speedometer (Race Mode Display)**

The gear position indicator display mode can be shifted while the motorcycle is at a stop:

- Select the stop watch mode. Refer to the “Multifunction Display” item in this section.
- While the motorcycle is at a stop, push and hold the upper button until the mode has been shifted.

### NOTE

- *The selection of the gear position indicator display mode is maintained if the ignition switch is turned “OFF”.*
- *When the battery is disconnected, the gear position indicator display mode is resets to normal mode.*
- *If the race mode display is selected, the clock is not displayed.*

**Clock -**

To adjust hours and minutes, do the followings while the motorcycle is at a stop.

- Turn the ignition switch to “ON”.
- Display the odometer in the multi-function display. Refer to the “Multi-function Display” item in this section.
- Push the lower button for more than 2 seconds. Both the hour and minute displays start blinking.

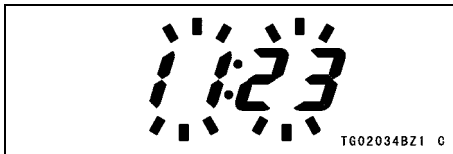

- Push the lower button. The hour display only blinks. Push the upper button to advance the hours.

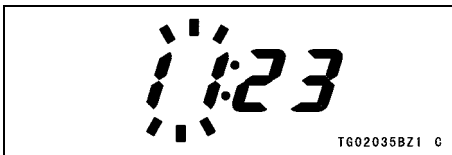

- Push the lower button. The hour display stops blinking and the minute display starts blinking. Push the upper button to advance the minutes.

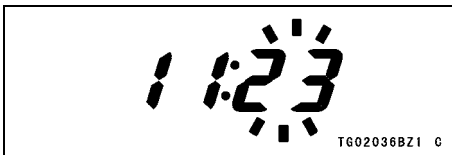

- Push the lower button. Both the hour and minute displays start blinking again.

## 46 GENERAL INFORMATION

- Push the upper button. The displays stop blinking and the clock starts working.

### NOTE

- *Pushing the upper button momentarily advances the hour or minute step by step. Pushing and holding the button advances the hour or minute continuously.*
- *The clock works normally by the back-up power while the ignition switch is turned "OFF".*
- *When the battery is disconnected, the clock is reset to 1:00 and starts working again when the battery is connected.*

### Economical Riding Indicator -

When the operator is driving the motorcycle for optimum fuel-efficiency, the economical riding indicator appears on the multifunction meter to indicate favorable fuel consumption. Monitoring the economical riding indicator can help the rider maximize fuel efficiency.



A. Economical Riding Indicator

## **⚠ WARNING**

Failing to properly observe the road ahead increases the chance of an accident resulting in severe injury or death. Do not concentrate on the economical riding indicator by taking your eyes off the road; observe using peripheral vision.

### **Power Mode Indicator -**

This indicator shows the selected Power Mode. For more detailed information about the power mode, see power mode section in the How to Ride the Motorcycle chapter.



**A. Power Mode Indicator**

### **NOTE**

- *When all power mode indicators go off, the battery voltage is insufficient. Have the machine checked by an authorized Kawasaki dealer promptly because the engine might stop suddenly if it is continued to run with a low battery.*



**S-KTRC Mode Indicator -**

This indicator shows the selected S-KTRC mode. For more detailed information about the S-KTRC mode, see Sport-Kawasaki TRaction Control (S-KTRC) section in the How to Ride the Motorcycle chapter.

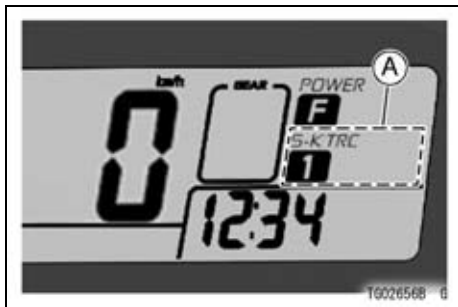

A. S-KTRC Mode Indicator

**NOTE**

- *When the all S-KTRC mode indicators go off, the battery voltage is insufficient. Have the machine checked by an authorized Kawasaki dealer promptly because the engine might stop suddenly when keeping running in that condition.*

**Warning/Indicator Lights**

**N** : When the transmission is in neutral, the neutral indicator light goes on.

 : When the headlight is on high beam, the high beam indicator light goes on.

 : When the turn signal switch is pushed to the left or right, the turn signal indicator light blinks.

### **KIBS Warning Indicator Light (For models equipped with KIBS) -**

The yellow warning indicator light in the meter unit functions as the KIBS warning indicator light. The yellow warning indicator light and warning symbol “KIBS” go on if there is a malfunction in the KIBS system. When the warning light is on, the KIBS system stops functioning. However, the ABS still functions normally if the KIBS system fails.

If the yellow warning indicator light and warning symbol “KIBS” go on, you should have the KIBS system checked by an authorized Kawasaki dealer.

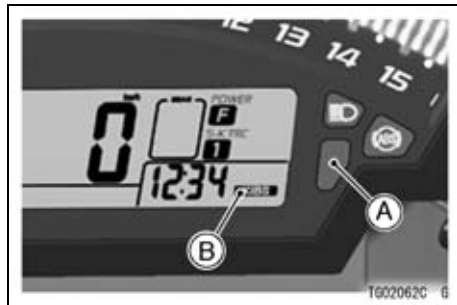

**A. Yellow Warning Indicator light**

**B. KIBS Symbol**

### Electronic Steering Damper Warning Indicator Light -

The yellow light functions as the electronic steering damper warning indicator. The light and warning symbol "ESD" go on if there is a malfunction in the electronic steering damper system. However, this could also be caused by trouble with the charging system (e.g. battery). If the warning light comes on, check the battery to be sure it is fully charged. If the battery is fully charged and the warning light still goes on, have the electronic steering damper system checked by an authorized Kawasaki dealer.

The electronic steering damper system maintains the last damping force setting if it fails.

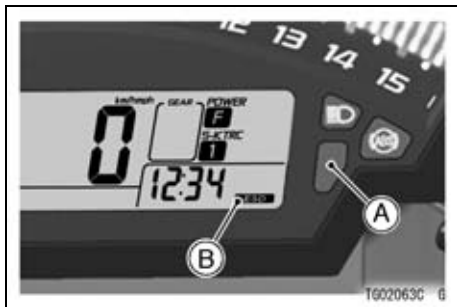

- A. Yellow Warning Indicator Light
- B. Electronic Steering Damper Warning Symbol

## **ABS Indicator Light (For models equipped with KIBS) -**

 : Normally the ABS indicator light goes on when the ignition switch is turned “ON” and goes off shortly after the motorcycle starts moving. If the ABS is normal, it stays off. If the ABS indicator light shows any of the following, a fault or faults may have taken place in the ABS. You should have the ABS checked by an authorized Kawasaki dealer.

- The light does not go on when the ignition switch is turned “ON”.
- The light remains lit after the motorcycle starts moving.
- The light goes on while riding.

## 52 GENERAL INFORMATION

Remember that the ABS does not function when the indicator light is on. If the ABS fails, the front and rear brakes work normally as a conventional brake system.

Status	Brake Condition	ABS Indicator Light	Warning Indicator Light (Yellow)	Multifunction Meter
Normal	KIBS	Goes off	Goes off	None
Engine information communication error	ABS	Goes off	Goes on	KIBS
Battery voltage decreases	Low voltage ABS	Blinks	Goes off	None
ABS error	Normal brake	Goes on	Goes off	None

### NOTE

- *The ABS indicator light may go on under certain riding conditions (ex. The front or rear wheel spins). In this case, first turn the ignition key to "OFF", and then back to "ON". This should reset the ABS indicator light, but if it remains lit after the motorcycle runs at approximately 5 km/h (3.1 mph) or more for more than one minute, you should have the ABS checked by an authorized Kawasaki dealer.*

- *When the ABS indicator light is blinking, the ABS has been in the low voltage mode (insufficient battery voltage). When it is in the low voltage mode, the KIBS system does not function, but the ABS functions. To recover the KIBS system, turn the ignition switch OFF and charge the battery. If the battery is fully charged and the low voltage mode continues, you should have the KIBS checked by an authorized Kawasaki dealer.*

## 54 GENERAL INFORMATION

### Fuel Level Warning Indicator Light -

 : The fuel level warning indicators are activated when approximately 3.8 L (1.0 US gal) of fuel remains as follows:

*For models without KIBS:*

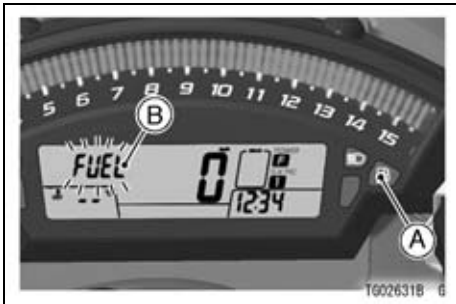



- A. Fuel Level Warning Indicator Light
- B. "FUEL" Indication

The fuel level warning indicator light () goes on and "FUEL" blinks in the multifunction display.

*For models equipped with KIBS:*



- A. Warning Indicator Light (Yellow)
- B. "FUEL" Indication
- C. Warning Symbol ()

The yellow warning indicator light and warning symbol () goes on, and "FUEL" blinks in the multifunction display.

Refuel at the earliest opportunity when the fuel level warning indicator light goes on and “FUEL” blinks.

When vehicle stands with side stand, the fuel level warning indicator light cannot show the amount of fuel in the fuel tank exactly. Stand upright the vehicle to check the fuel level.

### NOTE

- *When pushing the upper button while “FUEL” is displayed, the multifunction display can be shifted to odometer mode.*

### Warning Indicator Light (Red) -

This red warning indicator light and the oil pressure warning symbol (  ) should go on whenever the ignition switch is turned to “ON” and go off after starting the engine.

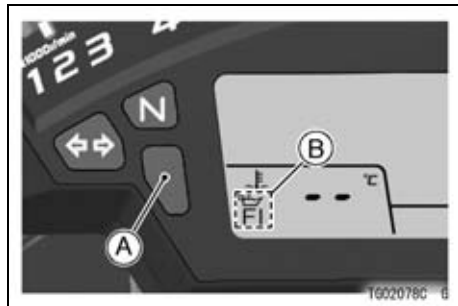

- A. Warning Indicator Light (Red)
- B. Warning Symbols





## 56 GENERAL INFORMATION

This red warning indicator light has the two warning functions: oil pressure warning and fuel injection system warning. This red warning indicator light goes on with each warning symbols: engine oil pressure warning symbol (  ) and fuel injection warning symbol ( **FI** ).

If the red warning indicator light goes on with the engine running, have its cause checked by an authorized Kawasaki dealer.

Refer to the “Warning Symbols” in this section for more detailed information.

### Warning Symbols -

 : The red warning indicator light and the oil pressure warning symbol (  ) goes on whenever the oil pressure is dangerously low or the ignition

switch is in the “ON” position with the engine not running, and go off when the engine oil pressure is high enough. Refer to the Maintenance and Adjustment chapter for more detailed engine oil information.

**FI** : The red warning indicator light and the fuel injection warning symbol ( **FI** ) goes on or blink whenever the ignition switch is turned to “ON” or trouble occurs in the fuel injection system. After turning the ignition switch to “ON”, the fuel injection warning symbol ( **FI** ) goes off soon after it is ensured that its circuit is functioning properly.

If the red warning indicator light and this warning symbol goes on or blink, have the FI system checked by an authorized Kawasaki dealer.

### S-KTRC Warning Indicator Light -

The yellow warning indicator light in the meter unit functions as the S-KTRC warning indicator light. The yellow warning indicator light and all S-KTRC mode indicators blink whenever there is a malfunction in the S-KTRC system. At this time, the S-KTRC system does not function.

If the yellow warning indicator light and all S-KTRC mode indicators blink, you should have the S-KTRC system checked by an authorized Kawasaki dealer.

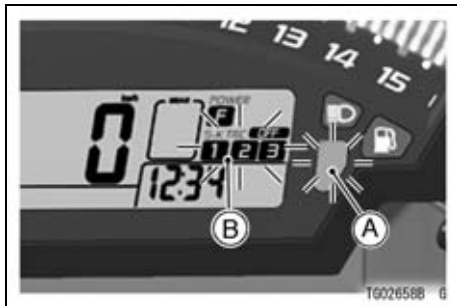

- A. Yellow Warning Indicator light
- B. S-KTRC Mode Indicator

## 58 GENERAL INFORMATION

### S-KTRC Level Indicator -

The instantaneous strength and weakness of the S-KTRC operation can be checked with the S-KTRC level indicator in the multifunction meter while the motorcycle is running. The stronger the traction control works, the more the segments go on.



A. S-KTRC Level Indicator

### Keys

This motorcycle has a combination key, which is used for the ignition switch, steering lock, seat lock, and fuel tank cap.

Included with the key is a key number, which may be stamped on a separate plate. Record the key number in the space provided and store the number in a safe place. If your keys came with a plate, store it in a safe place as well.

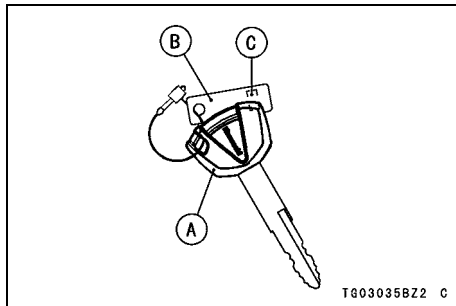

- A. Ignition Key
- B. Tag
- C. Key Number

Write your key number here.

In the event you lose your keys, you will need the key number to have a duplicate made. If you cannot locate your key number, contact the dealer where you purchased your Kawasaki motorcycle. It's possible the dealer may have the number in its records. If the key number is lost completely, you will need to replace the ignition switch and all other locks operated by that key.

Contact your Kawasaki dealer to purchase additional spare keys either using your original key as a master or using the key code on the tag or your key. Store one key at home and keep another spare in your wallet or riding gear, in case the original is lost.

## Ignition Switch/Steering Lock

This is a three-position, key-operated switch. The key can be removed from the switch when it is in the OFF or LOCK position.

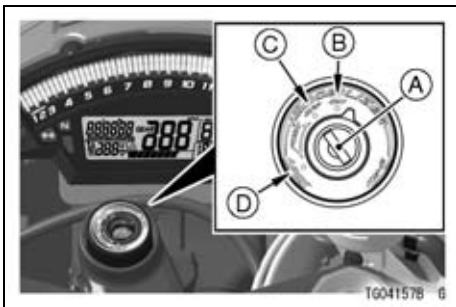

- A. Ignition Switch/Steering Lock
- B. ON position
- C. OFF position
- D. LOCK position

<b>ON</b>	Engine on. All electrical equipment can be used.
<b>OFF</b>	Engine off. Electrical circuits off.
<b>LOCK</b>	Steering locked. Engine off. Electrical circuits off.

### NOTE

- *The tail, city and license plate lights are on whenever the ignition key is in the "ON" position. One headlight goes on when the starter button is released after starting the engine. To avoid battery discharge, always start the engine immediately after turning the ignition key to "ON".*

## Left Handlebar Switches

To operate the ignition Switch:

OFF ↔ ON



LOCK

1. Turn the handlebar fully to the left.
2. For locking push down the key in the OFF position and turn it to LOCK.

TG04128BZ2 C

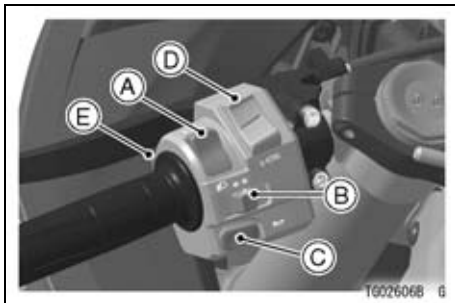



- A. Dimmer Switch
- B. Turn Signal Switch
- C. Horn Button
- D. Power/S-KTRC Button
- E. LAP/Passing Button

## 62 GENERAL INFORMATION

### Dimmer Switch

High or low beam can be selected with the dimmer switch. When the headlight is on high beam (  ), the high beam indicator light goes on.



High beam.....(  )

Low beam.....(  )

### NOTE

- *When the headlight is on high beam, both headlights go on. When the headlight is on low beam, only one headlight goes on.*

### Turn Signal Switch

When the turn signal switch is pushed to the left (  ) or right (  ), the corresponding turn signals blink on and off.

To stop blinking, push the switch in.

### Horn Button

When the horn button is pushed, the horn sounds.

### LAP/Passing Button

When the LAP/passing button is pushed, the headlight high beam (passing beam) goes on to signal the driver of the vehicle ahead that you are about to pass. The passing light is shut off as soon as the button is released.

Refer to the “Stop Watch” items in Multifunction Meter section for the LAP button functions.

### Power/S-KTRC Button

Refer to the S-KTRC or Power Mode System instructions of the “How to Ride the Motorcycle” chapter for operations.

## Right Handlebar Switches

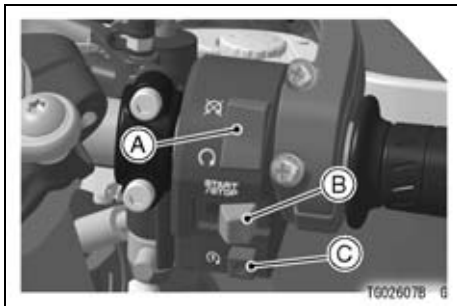

- A. Engine Stop Switch
- B. START/STOP Switch (for Stop Watch)
- C. Starter Button

### Engine Stop Switch

In addition to the ignition switch, the engine stop switch must be in the  position for the motorcycle to operate.

The engine stop switch is for emergency use. If required, move the switch to the  position.

### NOTE

- *Although the engine stop switch stops the engine, it does not turn off all the electrical circuits. Ordinarily, the ignition switch should be used to stop the engine.*

### Starter Button

The starter button operates the electric starter when the transmission is in neutral.

Refer to the Starting the Engine section of the “How to Ride the Motorcycle” chapter for starting instructions.



### **START/STOP Switch (for Stop Watch)**

Refer to the Multifunction Meter section of this chapter for stop watch instructions.

### **Brake Lever Adjuster**

There is an adjuster on the brake lever. The adjuster has 6 positions so that the released lever position can be adjusted to suit the operator's hands. Push the lever forward and turn the adjuster to align the number with the mark on the lever holder. The distance from the grip to the released lever is minimum at Number 6 and maximum at Number 1.

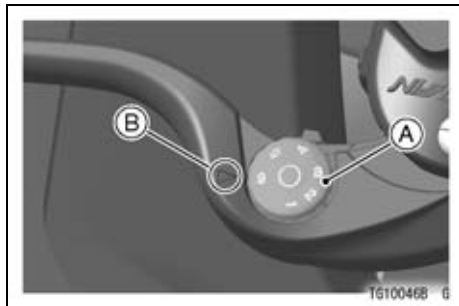

A. Adjuster

B. Mark

## Fuel Tank Cap

To open the fuel tank cap, pull up the key hole cover. Insert the ignition key into the fuel tank cap and turn the key to the right.

To close the cap, push it down into place with the key inserted. The key can be removed by turning it to the left to the original position. Close the key hole cover.

## NOTE

- *The fuel tank cap cannot be closed without the key inserted, and the key cannot be removed unless the cap is locked properly.*
- *Do not push on the key to close the cap, or the cap cannot be locked.*

## 66 GENERAL INFORMATION

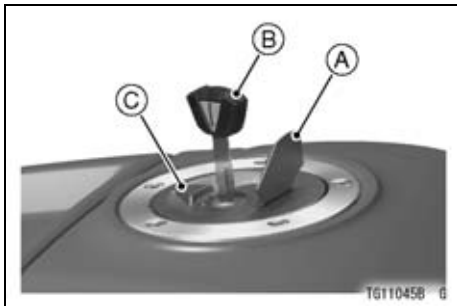

- A. Key Hole Cover
- B. Ignition Key
- C. Fuel Tank Cap

## Fuel Tank

The following octane rating gasoline is recommended for the fuel tank. Avoid filling the tank in the rain or where heavy dust is blowing so that the fuel does not get contaminated.

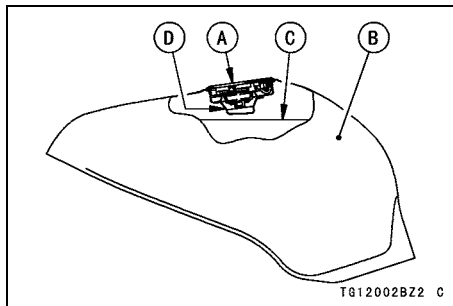

- A. Tank Cap
- B. Fuel Tank
- C. Top Level
- D. Filler Neck

 **WARNING**

Gasoline is extremely flammable and can be explosive under certain conditions, creating the potential for serious burns. Turn the ignition switch to "OFF". Do not smoke. Make sure the area is well-ventilated and free from any source of flame or sparks; this includes any appliance with a pilot light. Never fill the tank completely to the top. If the tank is filled completely to the top, heat may cause the fuel to expand and overflow through the vents in the tank cap. After refueling, make sure the tank cap is closed securely. If gasoline is spilled on the fuel tank, wipe it off immediately.

***NOTICE***

California model only: Never fill the tank so the fuel level rises into the filler neck. If the tank is overfilled, heat may cause the fuel to expand and flow into the Evaporative Emission Control System resulting in hard starting and engine hesitation and in compliance with the emission regulation.

## Fuel Requirement

### *Fuel Type*

Use clean, fresh unleaded gasoline with a minimum Antiknock Index of 90. The Antiknock Index is posted on service station pumps. The octane rating of a gasoline is a measure of its resistance to detonation or “knocking.” The Antiknock Index is an average of the Research Octane Number (RON) and the Motor Octane Number (MON) as shown in the table.

Octane Rating Method		Minimum Rating
Antiknock Index	$\frac{(\text{RON} + \text{MON})}{2}$	90

## **NOTICE**

**Use minimum of 90 octane gasoline only to prevent severe engine damage.**

## **NOTICE**

**If engine “knocking” or “pinging” occurs, use a different brand of gasoline of a higher octane rating. If this condition is allowed to continue it can lead to severe engine damage.**

**Gasoline quality is important. Fuels of low quality or not meeting standard industry specifications may result in unsatisfactory performance. Operating problems that result from the use of poor quality or nonrecommended fuel may not be covered under your warranty.**

### *Fuels Containing Oxygenates*

Gasoline frequently contains oxygenates (alcohols and ethers) especially in areas of the U.S. and Canada which are required to sell such reformulated fuels as part of a strategy to reduce exhaust emissions.

The types and volume of fuel oxygenates approved for use in unleaded gasoline by the U.S. Environmental Protection Agency include a broad range of alcohols and ethers, but only two components have seen any significant level of commercial use.

Gasoline/Alcohol Blends - Gasoline containing up to 10% ethanol (alcohol produced from agricultural products such as corn), also known as "gasohol" is approved for use.

## **NOTICE**

**Avoid using blends of unleaded gasoline and methanol (wood alcohol) whenever possible, and never use "gasohol" containing more than 5% methanol. Fuel system damage and performance problems may result.**

Gasoline/Ether Blends - The most common ether is methyl tertiary butyl ether (MTBE). You may use gasoline containing up to 15% MTBE.

## **NOTE**

- *Other oxygenates approved for use in unleaded gasoline include TAME (up to 16.7%) and ETBE (up to 17.2%). Fuel containing these oxygenates can also be used in your Kawasaki.*

## ***NOTICE***

Never use gasoline with an octane rating lower than the minimum specified by Kawasaki.

Never use “gasohol” with more than 10% ethanol, or more than 5% methanol. Gasoline containing methanol must also be blended with cosolvents and corrosion inhibitors.

Certain ingredients of gasoline may cause paint fading or damage. Be extra careful not to spill gasoline or gasoline oxygenate blends during refueling.

When not operating your Kawasaki for 30 to 60 days, mix a fuel stabilizer (such as STA-BIL) with the gasoline in the fuel tank. Fuel stabilizer additives inhibit oxidation of the fuel which minimizes gummy deposits.

## ***NOTICE***

Never store this product with “gasohol” in the fuel system. Before storage it is recommended that you drain all fuel from the fuel system. See the Storage section in this manual.

## Side Stand

The motorcycle is equipped with a side stand.



A. Side Stand

### NOTE

- *When using the side stand, turn the handlebar to the left.*

Do not sit on the motorcycle while it is on its side stand or centre stand. Always kick the stand fully up before sitting on the motorcycle.

### NOTE

- *The motorcycle is equipped with a side stand switch. This switch is designed so that the engine does not start if the transmission is in gear and the side stand is down.*



## Seats

### Passenger's Seat Removal

- Remove the passenger's seat by inserting the ignition key into the seat lock, and turning it clockwise.

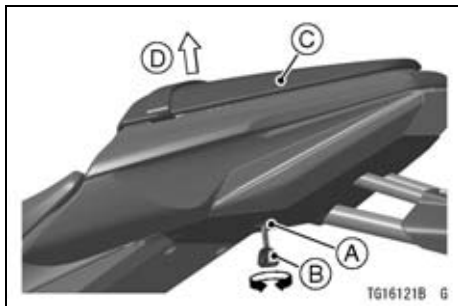

- A. Seat Lock
- B. Ignition Key
- C. Passenger's seat
- D. Pull up

## NOTE

- When removing the passenger's seat, pull it up while turning the key.

### Rider's Seat Removal

- Remove the bolts and seat cover.

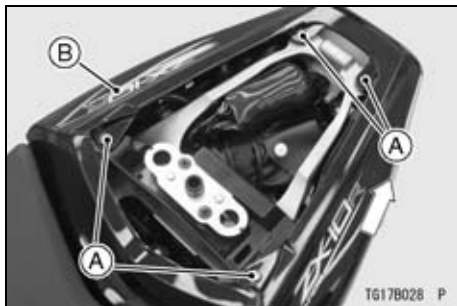

- A. Bolts
- B. Seat Cover

- Remove the mounting bolts and pull off the seat upward.

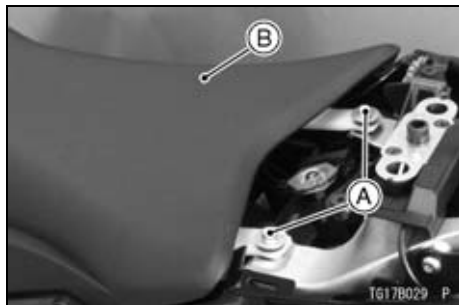

A. Mounting Bolts  
B. Rider's Seat

### *Rider's Seat Installation*

- Insert the tabs on the front of the rider's seat into the slots in the frame and secure the seat with mounting bolts.
- Install the seat cover and bolts.

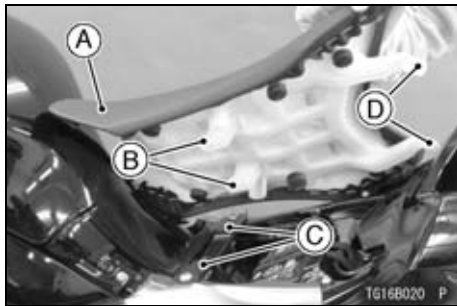

A. Rider's Seat  
B. Tabs  
C. Slots  
D. Stays

## 74 GENERAL INFORMATION

### *Passenger's Seat Installation*

- Insert the tab on the rear of the passenger's seat into the slot in the frame.
- Insert the projections at the front of the passenger's seat into the holes on the frame.

- Push down the front part of the passenger's seat until the lock clicks.

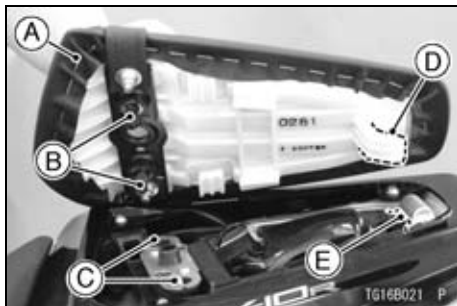

- A. Passenger's Seat
- B. Projections
- C. Holes
- D. Tab
- E. Slot

- Pull up the front and rear ends of the passenger's and rider's seats to make sure they are securely locked.

## Tool Kit

The tool kit is located under the passenger's seat.

The kit contains tools that are helpful in making roadside repairs, adjustments, and some maintenance procedures explained in this manual. Keep the tool kit in the original place.

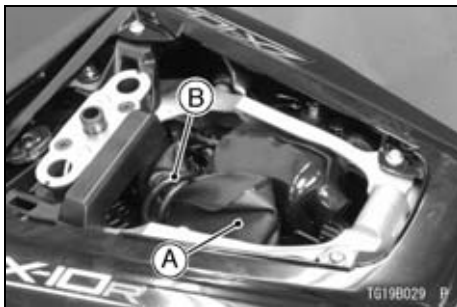

A. Tool Kit  
B. Band

## Air Cleaner Intake

The air cleaner intake allows air to enter the fuel system. Never allow anything to restrict the flow of air into the air cleaner. A restricted air cleaner will reduce performance and increase exhaust emissions.

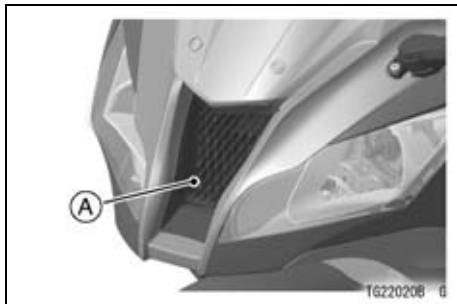

A. Air Cleaner Intake

## 76 GENERAL INFORMATION

### Front Footpeg Position

The right and left front footpegs can be selected to one of two positions to suit the front preferences. Have the front footpeg positions changed by an authorized Kawasaki dealer.

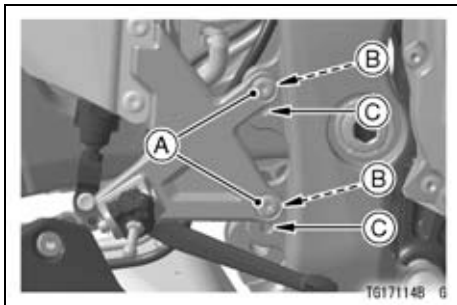

- A. Bolts
- B. Upper Position (Standard)
- C. Lower Position

### NOTE

- *Install the front footpegs with same height on both sides. Do not ride the motorcycle with footpegs installed unevenly.*

### Tightening Torque

Front Footpeg Bracket Bolts: 25 N·m (2.5 kgf·m, 18 ft·lb)
--------------------------------------------------------------

---

## BREAK-IN

---

The first 1 600 km (1 000 mi) that the motorcycle is ridden is designated as the break-in period. If the motorcycle is not used carefully during this period, you may very well end up with a “broken down” instead of a “broken in” motorcycle after a few thousand kilometers.

The following rules should be observed during the break-in period.

- The table shows maximum recommended engine speed during the break-in period.

Distance traveled	Maximum engine speed
0 ~ 800 km (0 ~ 500 mi)	4 000 r/min (rpm)
800 ~ 1 600 km (500 ~ 1 000 mi)	6 000 r/min (rpm)

### NOTE

- *When operating on public roadways, keep maximum speed under traffic low limits.*
- Do not start moving or race the engine immediately after starting it, even if the engine is already warm. Run the engine for two or three minutes at idle speed to give the oil a chance to work up into all the engine parts.
- Do not race the engine while the transmission is in neutral.

 **WARNING**

**New tires are slippery and may cause loss of control and injury. A break-in period of 160 km (100 miles) is necessary to establish normal tire traction. During break-in, avoid sudden and maximum braking and acceleration, and hard cornering.**

In addition to the above, at 1 000 km (600 mi) it is extremely important that the owner has the initial maintenance service performed by a competent mechanic following the procedures in the Service Manual.

## HOW TO RIDE THE MOTORCYCLE

### Starting the Engine

- Check that the engine stop switch is in the  position.

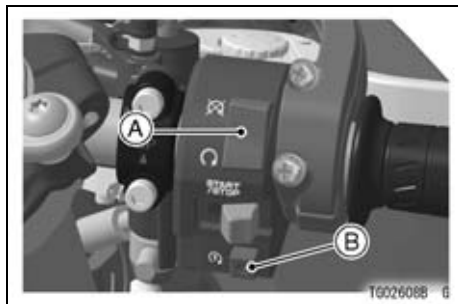

- A. Engine Stop Switch
- B. Starter Button

- Turn the ignition key to “ON”.
- Make sure the transmission is in neutral.

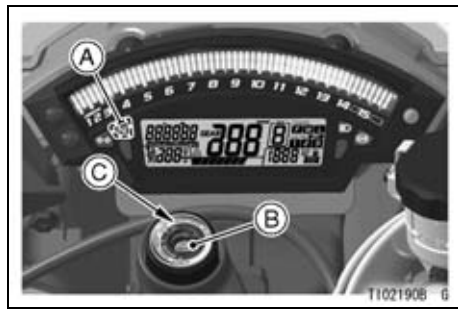

- A. Neutral Indicator Light
- B. Ignition Switch
- C. “ON” position



### NOTE

- *The motorcycle is equipped with a vehicle-down sensor, which causes the engine to stop automatically and the fuel injection warning symbol to go on or blink when the motorcycle falls down and the starter button pushed in. After righting the motorcycle, first turn the ignition key to “OFF” and then back to “ON” for a few seconds before starting the engine.*
- After the meter operation check, leaving the throttle completely closed, push the starter button.

### NOTICE

**Do not operate the starter continuously for more than 5 seconds, or the starter will overheat and the battery power will drop temporarily. Wait 15 seconds between each operation of the starter to let it cool and the battery power recover.**

### NOTE

- *While the engine is cold, the fast idle system automatically raises the engine idling speed. At this time, the red warning indicator light and the fuel injection warning symbol may go on if you operate the throttle grip unnecessarily.*

**NOTICE**

**Do not let the engine idle longer than five minutes, or engine overheating and damage may occur.**

- *The motorcycle is equipped with a starter lockout switch. This switch is designed so that the engine does not start if the transmission is in gear and the side stand is down. However, the engine can be started if the clutch lever is pulled and the side stand is fully up.*

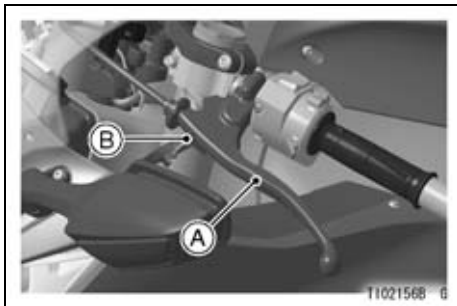

- A. Clutch Lever**  
**B. Starter Lockout Switch**

## Jump Starting

If your motorcycle battery is “run down”, it should be removed and charged. If this is not practical, a 12 volt booster battery and jumper cables may be used to start the engine.

### DANGER

**Battery acid generates hydrogen gas which is flammable and explosive under certain conditions. It is present within a battery at all times, even in a discharged condition. Keep all flames and sparks (cigarettes) away from the battery. Wear eye protection when working with a battery. In the event of battery acid contact with skin, eyes, or clothing, wash the affected areas immediately with water for at least 5 minutes. Seek medical attention.**

#### *Connecting Jumper Cables*

- Remove the rider's seat (see Seats section in the GENERAL INFORMATION chapter).

- Make sure the ignition switch is turned to “OFF”.
- Connect a jumper cable from the positive (+) terminal of the booster battery to the positive (+) terminal of the motorcycle battery. Refer to the “Battery Removal” section of the Maintenance and Adjustment chapter for the battery terminals.

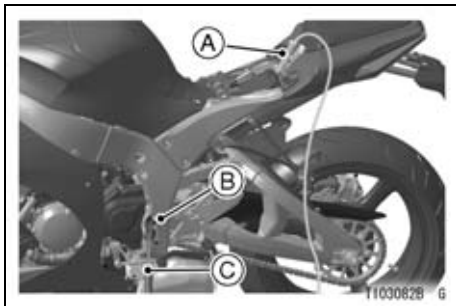

- A. From Booster Battery Positive (+) Terminal**
- B. Swingarm Pivot**
- C. From Booster Battery Negative (-) Terminal**

- Connect another jumper cable from the negative (-) terminal of the booster battery to your motorcycle swingarm pivot or other unpainted metal surface. Do not use the negative (-) terminal of the battery.

 **DANGER**

Batteries contain sulfuric acid that can cause burns and produce hydrogen gas which is highly explosive. Do not make this last connection at the fuel system or battery. Take care not to touch the positive and negative cables together, and do not lean over the battery when making this last connection. Do not connect to a frozen battery. It could explode. Do not reverse polarity by connecting positive (+) to negative (-), or a battery explosion and serious damage to the electrical system may occur.

- Follow the standard engine starting procedure.

**NOTICE**

Do not operate the starter continuously for more than 5 seconds or the starter will overheat and the battery power will drop temporarily. Wait 15 seconds between each operation of the starter to let it cool and the battery power recover.

- After the engine has started, disconnect the jumper cables. Disconnect the negative (-) cable from the motorcycle first.
- Reinstall the removed parts.

## Moving Off

- Check that the side stand is up.
- Pull in the clutch lever.
- Shift into 1st gear.
- Open the throttle a little, and start to let out the clutch lever very slowly.
- As the clutch starts to engage, open the throttle a little more, giving the engine just enough fuel to keep it from stalling.

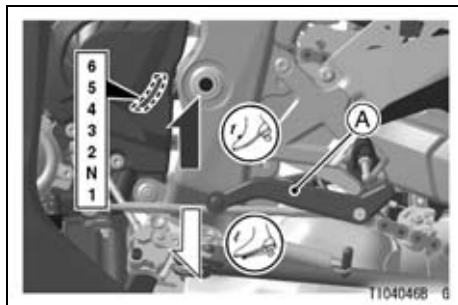

A. Shift Pedal

## NOTE

- *The motorcycle is equipped with a side stand switch. This switch is designed so that the engine does not start if the transmission is in gear and the side stand is down.*
- *When the headlight is on high beam, two headlight beams go on, and on low beam, the one side of the headlight goes on.*

## Shifting Gears

- Close the throttle while pulling in the clutch lever.
- Shift into the next higher or lower gear.
- Open the throttle part way, while releasing the clutch lever.
- For smooth riding, each gear position should cover the proper rate of speed shown in the table.



## WARNING

**Downshifting to a lower gear at high speed causes engine rpm to increase excessively, potentially damaging the engine and it may also cause the rear wheel to skid and cause an accident.**

**Vehicle speed when shifting**

Shifting up	km/h (mph)	Shifting down	km/h (mph)
1st → 2nd	15 ( 9)	6th → 5th	30 (19)
2nd → 3rd	25 (15)	5th → 4th	25 (15)
3rd → 4th	35 (21)	4th → 3rd	20 (12)
4th → 5th	45 (27)	3rd → 2nd	15 ( 9)
5th → 6th	55 (34)	2nd → 1st	15 ( 9)

**NOTE**

- *The transmission is equipped with a positive neutral finder. When the motorcycle is standing still, the transmission cannot be shifted past neutral from 1st gear. To use the positive neutral finder, shift down to 1st gear, then lift up on the shift pedal while standing still. The transmission will shift only into neutral.*



## Braking

- Close the throttle completely, leaving the clutch engaged (except when shifting gears) so that the engine will help slow down the motorcycle.
- Shift down one gear at a time so that you are in 1st gear when you come to a complete stop.
- When stopping, always apply both brakes at the same time. Normally the front brake should be applied a little more than the rear. Shift down or fully disengage the clutch as necessary to keep the engine from stalling.
- Never lock the brakes, or it will cause the tires to skid. When turning a corner, it is better not to brake at all. Reduce your speed before you get into the corner.

- For emergency braking, disregard downshifting, and concentrate on applying the brakes as hard as possible without skidding.

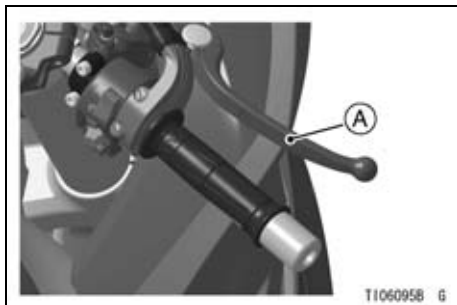

A. Front Brake Lever

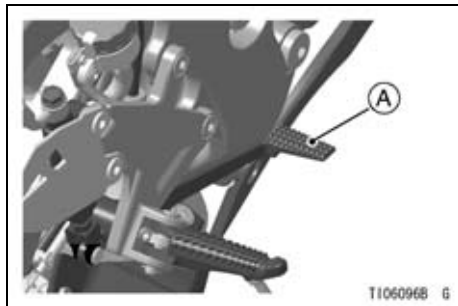

**A. Rear Brake Pedal**

## **Kawasaki Intelligent anti-lock Brake System (KIBS, For models equipped with KIBS)**

KIBS regulates anti-lock braking performance with more precision during sports riding compared to a conventional ABS system.

KIBS is designed to help prevent the wheels from locking up when the brakes are applied hard while riding straight. KIBS automatically regulates brake force using engine data in addition to front and rear wheel speed to help prevent wheel lock-up and allows more stable steering control while stopping.

KIBS helps provide stability while stopping by preventing wheel lock-up, but you should be aware of the following:

- To apply the brakes effectively, use the front brake lever and rear brake pedal simultaneously in the same

## 90 HOW TO RIDE THE MOTORCYCLE

manner as a conventional motorcycle brake system.

- KIBS cannot compensate for adverse road conditions, misjudgment or improper application of brakes. You must use the same discretion as you would with motorcycles not equipped with KIBS.
- KIBS is not designed to shorten the braking distance. On loose, uneven or downhill surfaces, the stopping distance of a motorcycle with KIBS may be longer than that of an equivalent motorcycle without KIBS. Use special caution in such areas.
- KIBS will help prevent wheel lock-up when braking in a straight line, but it cannot control wheel slip which may be caused by braking during cornering. When turning a corner, it is better to limit braking to a light application of both brakes or not to brake at

all. Reduce your speed before you get into the corner.

- Same as conventional brake system, an excessive sudden braking may cause wheel lock up that makes it harder to control a motorcycle.
- KIBS will not prevent the rear wheel lifting.

### **WARNING**

**KIBS cannot protect the rider from all possible hazards and is not a substitute for safe riding practices. Be aware of how the KIBS system operates and its limitations. It is the rider's responsibility to ride at appropriate speeds and manner for weather, road surface and traffic conditions.**

- The computers integrated in the KIBS compares vehicle speed with wheel speed. Since non-recommended tires can affect wheel speed, they may cause the computers to make incorrect calculations that can extend braking distance.

 **WARNING**

**Use of non-recommended tires can cause the KIBS to malfunction and lead to extended braking distance, resulting in a crash causing serious injury or death. Always use the recommended standard tires for this motorcycle.**

**NOTE**

- *When the KIBS is functioning, you may feel a pulsing in the brake lever and/or pedal. This is normal. Maintain pressure on the lever and/or pedal for most effective braking.*
- *KIBS does not function below speeds of approx. 5 km/h (3.1 mph).*
- *KIBS does not function if the battery is discharged. When riding with an insufficiently charged battery, KIBS may not function. Keep the battery in good condition according to the “Battery Maintenance” section.*

## Stopping the Engine

- Close the throttle completely.
- Shift the transmission into neutral.
- Turn the ignition key to “OFF”.
- Support the motorcycle on a firm, level surface with the side stand.
- Lock the steering.

### NOTE

- *The motorcycle is equipped with a vehicle-down sensor, which causes the engine to stop automatically and the fuel injection warning symbol to go on or blink when the motorcycle falls down and the starter button is pushed in. After righting the motorcycle, first turn the ignition key to “OFF” and then back to “ON” for a few seconds before starting the engine.*

## Stopping the Motorcycle in an Emergency

Your Kawasaki Motorcycle has been designed and manufactured to provide you optimum safety and convenience. However, in order to fully benefit from Kawasaki’s safety engineering and craftsmanship, it is essential that you, the owner and operator, properly maintain your motorcycle and become thoroughly familiar with its operation. Improper maintenance can create a dangerous situation known as throttle failure. Two of the most common causes of throttle failure are:

1. An improperly serviced or clogged air cleaner may allow dirt and dust to enter the throttle body and stick the throttle open.
2. During removal of the air cleaner, dirt is allowed to enter and jam the fuel injection system.

In an emergency situation such as throttle failure, your vehicle may be stopped by applying the brakes and disengaging the clutch. Once this stopping procedure is initiated, the engine stop switch may be used to stop the engine. If the engine stop switch is used, turn off the ignition switch after stopping the motorcycle.

## Parking

### **WARNING**

**Operating or parking the vehicle near flammable materials can cause a fire, and can result in property damage or severe personal injury.**

**Do not idle or park your vehicle in an area where tall or dry vegetation, or other flammable materials could come into contact with the muffler or exhaust pipe.**

 **WARNING**

**The engine and exhaust system get extremely hot during normal operation and can cause serious burns.**

**Never touch a hot engine, exhaust pipe, or muffler during operation or after stopping the engine.**

- Shift the transmission into neutral and turn the ignition key to “OFF”.
- Support the motorcycle on a firm, level surface with the side stand.

***NOTICE***

**Do not park on a soft or steeply inclined surface, or the motorcycle may fall over.**

- If parking inside a garage or other structure, be sure it is well ventilated and the motorcycle is not close to any source of flame or sparks; this includes any appliance with a pilot light.

 **WARNING**

**Gasoline is extremely flammable and can be explosive under certain conditions.**

- Lock the steering to prevent theft.

## Catalytic Converter

This motorcycle is equipped with a catalytic converter in the exhaust system. The converter reacts with carbon monoxide, hydrocarbons and nitrogen oxides to convert them into carbon dioxide, water, nitrogen and oxygen resulting in much cleaner exhaust gases to be discharged into the atmosphere.

For proper operation of the catalytic converter, the following cautions must be observed.

### **WARNING**

**Operating or parking the vehicle near flammable materials can cause a fire, and can result in property damage or severe personal injury.**

**Do not idle or park your vehicle in an area where tall or dry vegetation, or other flammable materials could come into contact with the muffler or exhaust pipe.**

### **WARNING**

**The engine and exhaust system get extremely hot during normal operation and can cause serious burns.**

**Never touch a hot engine, exhaust pipe, or muffler during operation or after stopping the engine.**



- Use only unleaded gasoline. Never use leaded gasoline. Leaded gasoline significantly reduces the capability of the catalytic converter.
- Do not operate the vehicle with the engine of any one cylinder misfiring. Under these conditions unburned air/fuel mixture flowing out of engine excessively accelerates reaction in the converter allowing the converter to overheat and become damaged when the engine is hot, or reduces converter performance when the engine is cold.

### **Sport-Kawasaki TRaction Control (S-KTRC)**

S-KTRC is an intelligent system that calculates the slip level of the rear wheel (wheelspin) and is suitable for sports riding conditions. S-KTRC is designed to function on public roads.

Acceleration may be delayed under certain circumstances depending on road conditions. S-KTRC cannot respond to every condition.

 **WARNING**

**S-KTRC cannot protect the rider from all possible hazards and is not a substitute for safe riding practices. All riders must be aware of how the S-KTRC system operates and its limitations. It is still your responsibility to ride at appropriate speeds and throttle control for weather, road surface and traffic conditions.**

The S-KTRC functions at 5 km/h (3.1 mph) or more, and stops functioning at 4 km/h (2.5 mph) or below.

 **WARNING**

**Use of nonrecommended tires could cause a malfunction or improper operation of S-KTRC. Always use recommended standard tires for this motorcycle.**

**MODES -**

The S-KTRC determines the traction control characteristics with three mode selections. The S-KTRC can also be set to OFF.

The S-KTRC and the Power mode can be set separately. By combining each setting, the rider can get various riding feelings.

**MODE 1:**

The S-KTRC least intervenes among the three modes. This makes lengthy drifts and wheelies possible when exiting tight corners.

**MODE 2:**

There is more S-KTRC intervention compared to mode 1. This makes slight drifts possible when exiting tight corners.

## 98 HOW TO RIDE THE MOTORCYCLE

### MODE 3:

The S-KTRC intervenes early enough to prevent the rear wheel from spinning whenever possible.

[Example]

(Actual ranges vary with rider skills)

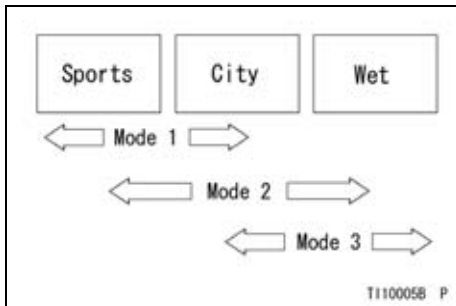

### S-KTRC Button -

Use the S-KTRC button on the left handle switch to set the S-KTRC mode.

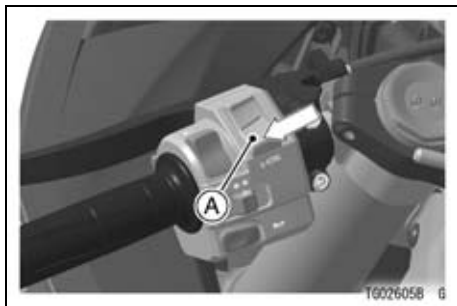

A. S-KTRC Button (Lower Part)

### S-KTRC setting -

The mode can be changed only when the throttle grip is closed completely.

### NOTE

○ *When changing the mode, stop the motorcycle.*

- Close the throttle grip completely.
- Hold down (0.3 ~ 0.4 seconds) the S-KTRC button on the left handlebar switch to change the mode.

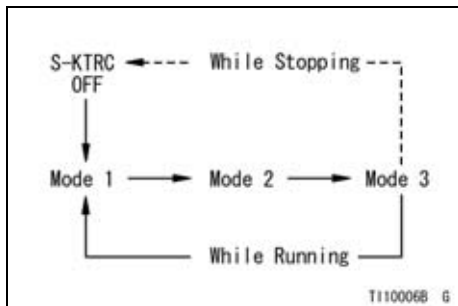

### NOTE

- Check the indicator to make sure that the mode has been changed.
- The S-KTRC OFF can be selected only when the motorcycle is at a stop.

- Changing to mode 1 from the S-KTRC OFF is possible while running.



A. S-KTRC OFF Indicator

### NOTE

- The mode setting of the S-KTRC is maintained if the ignition switch is turned to OFF position.

## 100 HOW TO RIDE THE MOTORCYCLE

- *When the ignition switch is turned to OFF position, and then back to ON position while the S-KTRC is OFF, the S-KTRC is set in the mode 1.*
- *The mode setting of the S-KTRC is maintained if the battery is disconnected.*
- *When the battery is disconnected, and then it is connected while the S-KTRC is OFF, the S-KTRC is set in the mode 1.*

### **Power mode**

The Power mode determines the engine power output characteristics and has three settings.

The S-KTRC and the Power mode can be set separately. By combining each setting, the rider can get various power feelings to suit riding conditions or individual preference.

#### **Mode F (Full Power):**

The highest engine power output is achieved. The rider can feel the full throttle response of the engine.

#### **Mode M (Middle Power):**

The throttle response is less sharp compared to the mode F.

Depending throttle application full power can be accessed temporarily.

**Mode L (Low Power):**

About 60% of the highest engine power output is achieved. The throttle response is mildest among the three modes.

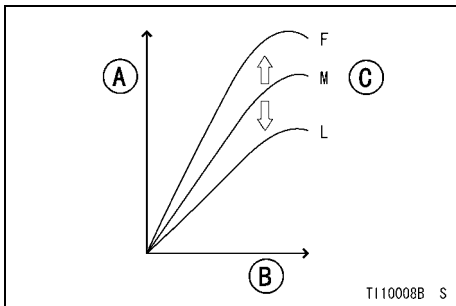

**A. Power**

**B. Engine rpm**

**C. Depending on Throttle Angle**

**Power mode Button -**

For the power mode setting, use the power mode button on the left handle-bar switch.

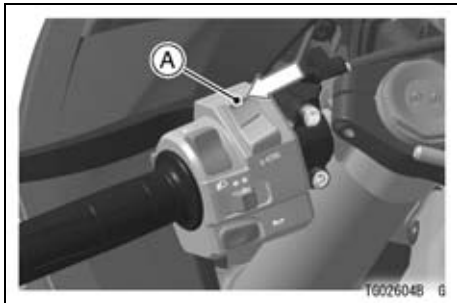

**A. Power mode Button (Upper Part)**

**Power mode setting -**

The mode can be changed only when the throttle grip is closed completely.

## 102 HOW TO RIDE THE MOTORCYCLE

### NOTE

- *When changing the mode, stop the motorcycle.*
- Close the throttle grip completely.
- Hold down (0.3 ~ 0.4 seconds) the Power button on the left handlebar switch to change the mode.

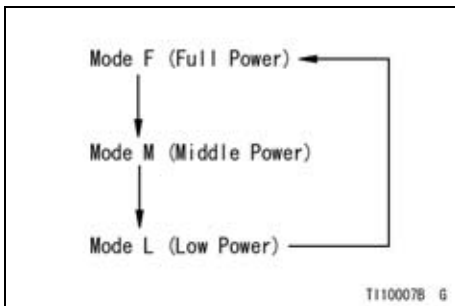

### NOTE

- *Check the indicator to make sure that the mode has been changed.*
- *The Power mode setting is maintained if the ignition switch is turned to OFF position, or if the battery is disconnected.*

---

## SAFE OPERATION

---

### Safe Riding Technique

The points given below are applicable for everyday motorcycle use and should be carefully observed for safe and effective vehicle operation.

For safety, eye protection and a helmet are strongly recommended. You should be aware of and verify the applicable safety regulations in force prior to riding your motorcycle. Gloves and suitable footwear should also be used for added protection in case of a mishap.

A motorcycle does not provide the impact protection of an automobile, so defensive riding in addition to wearing protective apparel is extremely important. Do not let protective apparel give you a false sense of security.

When riding always keep both hands on the handlebars and both feet on the footpegs. Removing your hands from the handlebars or feet from the footpegs while riding can be hazardous. If you remove even one hand or foot, you can reduce your ability to control the motorcycle.

Before changing lanes, look over your shoulder to make sure the way is clear. Do not rely solely on the rear view mirror; you may misjudge a vehicle's distance and speed, or you may not see it at all.



In general your actions should be smooth as sudden acceleration, braking or turning may cause loss of control, especially when riding in wet conditions or on loose roadway surfaces, when the ability to maneuver will be reduced.

When going up steep slopes, shift to a lower gear so that there is plenty of power to spare rather than overloading the engine.

When applying the brakes, use both the front and rear brakes. Applying only one brake for sudden braking may cause the motorcycle to skid and lose control.

When going down long slopes, control vehicle speed by closing the throttle. Use the front and rear brakes for auxiliary braking.

In wet conditions, rely more on the throttle to control vehicle speed and less on the front and rear brakes. The throttle should also be used judiciously to avoid skidding the rear wheel from too rapid acceleration or deceleration.

Riding at the proper rate of speed and avoiding unnecessarily fast acceleration are important not only for safety and low fuel consumption but also for long vehicle life and quieter operation.

On rough roads, exercise caution, slow down, and grip the fuel tank with knees for better stability.

When quick acceleration is necessary as in passing, shift to a lower gear to obtain the necessary power.

**Do not downshift at too high an r/min (rpm) to avoid damage from overrevving to the engine.**

**Avoiding unnecessary weaving is important to the safety of both the rider and other motorists.**



## Daily Checks

Check the following items each day before you ride. The time required is minimal, and habitual performance of these checks will help ensure you a safe, reliable ride.

If any irregularities are found during these checks, refer to the Maintenance and Adjustment chapter or see your dealer for the action required to return the motorcycle to a safe operating condition.

### **WARNING**

**Failure to perform these checks before operation may result in serious damage or an accident. Always perform daily checks before operation.**

### **DANGER**

**Exhaust gas contains carbon monoxide, a colorless, odorless poisonous gas.**

**Inhaling carbon monoxide can cause serious brain injury or death.**

**Do not run the engine in enclosed areas. Operate only in a well-ventilated area.**

Fuel ..... Adequate supply in tank, no leaks.

Engine oil ..... Oil level between level lines.

Tires ..... Air pressure (when cold):

Front	250 kPa (2.50 kgf/cm <sup>2</sup> , 36 psi)
Rear	290 kPa (2.90 kgf/cm <sup>2</sup> , 42 psi)

Install the air valve cap.

Drive chain ..... Slack 25 ~ 35 mm (1.0 ~ 1.4 in.).

Lubricate when chain is dry.

Nuts, bolts, fasteners .. Check that steering and suspension components, axles, and all controls are properly tightened or fastened.

Steering ..... Action smooth but not loose from lock to lock.

No binding of control cables.

Electronic Steering Damper Unit: No oil leakage.

Brakes ..... Brake pad wear: Lining thickness more than 1 mm (0.04 in.) left.

No brake fluid leakage.

Throttle ..... Throttle grip play 2 ~ 3 mm (0.08 ~ 0.12 in.).

Clutch ..... Clutch lever play 2 ~ 3 mm (0.08 ~ 0.12 in.).

Clutch lever operates smoothly.

Coolant ..... No coolant leakage.

Coolant level between level lines (when engine is cold).

Electrical equipment ... All lights (Headlight, Tail/Brake Lights, Turn Signal Lights, Warning/Indicator Lights) and horn work.

Engine stop switch ..... Stops engine.

## 108 SAFE OPERATION

Side stand ..... Return to its fully up position by spring tension.  
Return spring not weak or not damaged.

## Additional Considerations for High Speed Operation

**Brakes:** The importance of the brakes, especially during high speed operation, cannot be overemphasized. Check to see that they are correctly adjusted and functioning properly.

**Steering:** Looseness in the steering can cause loss of control. Check to see that the handlebar turns freely but has no play.

**Tires:** High speed operation is hard on tires, and good tires are crucial for riding safety. Examine their overall condition, inflate them to the proper pressure, and check the wheel balance.

**Fuel:** Have sufficient fuel for the high fuel consumption during high speed operation.

**Engine Oil:** To avoid engine seizure and resulting loss of control, make sure that the oil level is at the upper level line.

**Coolant:** To avoid overheating, check that the coolant level is at the upper level line.

**Electrical Equipment:** Make sure that the headlight, tail/brake light, turn signals, horn, etc., all work properly.

**Miscellaneous:** Make sure that all nuts and bolts are tight and that all safety related parts are in good condition.

 **WARNING**

**Handling characteristics of a motorcycle at high speeds may vary from those you are familiar with at legal highway speeds. Do not attempt high speed operation unless you have received sufficient training and have the required skills.**

---

## MAINTENANCE AND ADJUSTMENT

---

The maintenance and adjustments outlined in this chapter must be carried out in accordance with the Periodic Maintenance Chart to keep the motorcycle in good running condition. **The initial maintenance is vitally important and must not be neglected.**

With a basic knowledge of mechanics and the proper use of tools, you should be able to carry out many of the maintenance items described in this chapter. If you lack proper experience or doubt your ability, all adjustments, maintenance, and repair work should be completed by a qualified technician.

Please note that Kawasaki cannot assume any responsibility for damage resulting from incorrect or improper adjustment done by the owner.



## EMISSION CONTROL INFORMATION

To protect the environment in which we all live, Kawasaki has incorporated crankcase emission (1) and exhaust emission (2) control systems in compliance with applicable regulations of the United States Environmental Protection Agency and California Air Resources Board. Additionally, Kawasaki has incorporated an evaporative emission control system (3) in compliance with applicable regulations of the United States Environmental Protection Agency and California Air Resources Board.

### 1. Crankcase Emission Control System

This system eliminates the release of crankcase vapors into the atmosphere. Instead, the vapors are routed through an oil separator to the intake side of the engine. While the engine is operating, the vapors are drawn into the combustion chamber, where they are burned along with the fuel and air supplied by the fuel injection system.

### 2. Exhaust Emission Control System

This system reduces the amount of pollutants discharged into the atmosphere by the exhaust of this motorcycle. The fuel, ignition and exhaust systems of this motorcycle have been carefully designed and constructed to ensure an efficient engine with low exhaust pollutant levels. The exhaust system of this model motorcycle includes a catalytic converter system.

### **3. Evaporative Emission Control System**

The evaporative emission control system for this vehicle consists of low permeation fuel hoses and fuel tank.

### **3. Evaporative Emission Control System (California model only)**

Vapors caused by fuel evaporation in the fuel system are not vented into the atmosphere. Instead, fuel vapors are routed into the running engine to be burned, or stored in a canister when the engine is stopped. Liquid fuel is caught by a vapor separator and returned to the fuel tank.

### **High Altitude Performance Adjustment Information**

High Altitude adjustment is not required.

## MAINTENANCE AND WARRANTY

Proper maintenance is necessary to ensure that your motorcycle will continue to have low emission levels. This Owner's Manual contains those maintenance recommendations for your motorcycle. Those items identified by the Periodic Maintenance Chart are necessary to ensure compliance with the applicable standards.

As the owner of this motorcycle, you have the responsibility to make sure that the recommended maintenance is carried out according to the instructions in this Owner's Manual at your own expense.

The Kawasaki Limited Emission Control System Warranty requires that you return your motorcycle to an authorized Kawasaki dealer for remedy under warranty. Please read the warranty carefully, and keep it valid by complying with the owner's obligations it contains.

You should keep a maintenance record for your motorcycle. To assist you in keeping this record, we have provided space on pages 225 through 228 of this manual where an authorized Kawasaki dealer, or someone equally competent, can record the maintenance. You should also retain copies of maintenance work orders, bills, etc., as verification of this maintenance.

## TAMPERING WITH NOISE CONTROL SYSTEM PROHIBITED:

Federal law prohibits the following acts or the causing thereof: (1) the removal or rendering inoperative by any person other than for purposes of maintenance, repair, or replacement, of any device or element of design incorporated into any new vehicle for the purpose of noise control prior to its sale or delivery to the ultimate purchaser or while it is in use, or (2) the use of the vehicle after such device or element of design has been removed or rendered inoperative by any person.

Among those acts presumed to constitute tampering are the acts listed below:

- \* Replacement of the original exhaust system or muffler with a component not in compliance with Federal regulations.
- \* Removal of the muffler(s) or any internal portion of the muffler(s).
- \* Removal of the air box or air box cover.
- \* Modifications to the muffler(s) or air intake system by cutting, drilling, or other means if such modifications result in increased noise levels.

### Periodic Maintenance Chart

K : Should be serviced by an authorized Kawasaki dealer.

\* : For higher odometer readings, repeat at the frequency interval established here.

# : Service more frequently when operating in severe conditions: dusty, wet, muddy, high speed, or frequent starting/stopping.

(e): Emission Related Item

# 116 MAINTENANCE AND ADJUSTMENT

## 1. Periodic Inspection (Engine Related Items)

Operation (Engine Items)	Frequency	Whichever comes first ↓	*Odometer Reading km × 1 000 (mile × 1 000)						See Page	
			→	1 (0.6)	6 (3.75)	12 (7.5)	18 (11.25)	24 (15)		30 (18.75)
Valve clearance - inspect (e)		Every					●		142	
Throttle control system (play, smooth return, no drag) - inspect (e)	year		●		●		●		●	150
<b>K</b> Engine vacuum synchronization - inspect (e)					●		●		●	153
<b>K</b> Idle speed - inspect (e)			●		●		●		●	153
<b>K</b> Fuel leak (fuel hose and pipe) - inspect	year		●		●		●		●	—

Frequency	Operation (Engine Items)	Whichever comes first ↓ Every	*Odometer Reading km × 1 000 (mile × 1 000)						See Page	
			1 (0.6)	6 (3.75)	12 (7.5)	18 (11.25)	24 (15)	30 (18.75)		36 (22.5)
<b>K</b>	Fuel hoses damage - inspect	year	●		●		●		●	–
<b>K</b>	Fuel hoses installation condition - inspect	year	●		●		●		●	–
	Coolant level - inspect		●		●		●		●	136
	Coolant leak - inspect	year	●		●		●		●	134
	Radiator hoses damage - inspect	year	●		●		●		●	134
	Radiator hoses installation condition - inspect	year	●		●		●		●	134

## 118 MAINTENANCE AND ADJUSTMENT

Frequency	Whichever comes first →								See Page
	*Odometer Reading km × 1 000 (mile × 1 000)								
Operation (Engine Items)	Every	1 (0.6)	6 (3.75)	12 (7.5)	18 (11.25)	24 (15)	30 (18.75)	36 (22.5)	
Evaporative emission control system - function (California model only) (e)		•	•	•	•	•	•	•	141
<b>K</b> Air suction system damage - inspect (e)				•		•		•	143

## 2. Periodic Inspection (Chassis Related Items)

Frequency  Operation (Chassis Items)	Whichever comes first → ↓ *Odometer Reading km × 1000 (mile × 1000)								See Page
	Every	1 (0.6)	6 (3.75)	12 (7.5)	18 (11.25)	24 (15)	30 (18.75)	36 (22.5)	
<b>Clutch and drive train:</b>									
Clutch operation (play, engagement, disengagement) - inspect		•		•		•		•	154
Drive chain lubrication condition - inspect #	every 600 km (400 mile)								164
Drive chain slack - inspect #	every 1 000 km (600 mile)								157
Drive chain wear - inspect #				•		•		•	161



## 120 MAINTENANCE AND ADJUSTMENT

Frequency	Whichever comes first →								See Page
	↓	*Odometer Reading km × 1000 (mile × 1000)							
Operation (Chassis Items)	Every	1 (0.6)	6 (3.75)	12 (7.5)	18 (11.25)	24 (15)	30 (18.75)	36 (22.5)	
<b>K</b> Drive chain guide wear - inspect				•		•		•	–
<b>Wheels and tires:</b>									
Tire air pressure - inspect	year			•		•		•	186
Wheels/tires damage - inspect				•		•		•	187
Tire tread wear, abnormal wear - inspect				•		•		•	187
<b>K</b> Wheel bearings damage - inspect	year			•		•		•	–



## 122 MAINTENANCE AND ADJUSTMENT

Frequency	Whichever comes first →								See Page
	↓	*Odometer Reading km × 1000 (mile × 1000)							
Operation (Chassis Items)	Every	1 (0.6)	6 (3.75)	12 (7.5)	18 (11.25)	24 (15)	30 (18.75)	36 (22.5)	
Brake operation (effectiveness, play, drag) - inspect	year	•	•	•	•	•	•	•	168
Brake light switch operation - inspect		•	•	•	•	•	•	•	169
<b>Suspensions:</b>									
Front forks/rear shock absorber operation (damping and smooth stroke) - inspect				•		•		•	172/ 178
Front forks/rear shock absorber oil leak - inspect	year			•		•		•	172/ 178

Frequency	Whichever comes first →								See Page
	↓	*Odometer Reading km × 1000 (mile × 1000)							
Operation (Chassis Items)	Every	1 (0.6)	6 (3.75)	12 (7.5)	18 (11.25)	24 (15)	30 (18.75)	36 (22.5)	
<b>K</b> Rocker arm operation - inspect				●		●		●	–
<b>K</b> Tie rods operation - inspect				●		●		●	–
<b>Steering system:</b>									
<b>K</b> Steering play - inspect	year	●		●		●		●	–
<b>K</b> Steering stem bearings - lubricate	2 years					●			–
Electronic steering damper oil leak - inspect			●	●	●	●	●	●	171

## 124 MAINTENANCE AND ADJUSTMENT

Frequency	Whichever comes first →							*Odometer Reading km × 1000 (mile × 1000)	See Page
	↓	1 (0.6)	6 (3.75)	12 (7.5)	18 (11.25)	24 (15)	30 (18.75)		
Operation (Chassis Items)	Every								
<b>Electrical system:</b>									
Lights and switches operation - inspect	year			●		●		●	–
Headlight aiming - inspect	year			●		●		●	196
Side stand switch operation - inspect	year			●		●		●	–
Engine stop switch operation - inspect	year			●		●		●	–

Frequency	*Odometer Reading km × 1000 (mile × 1000)								See Page	
	Operation (Chassis Items)	1 (0.6)	6 (3.75)	12 (7.5)	18 (11.25)	24 (15)	30 (18.75)	36 (22.5)		
<b>Chassis:</b>										
<b>K</b>	Chassis parts - lubricate	year			●		●		●	202
<b>K</b>	Bolts and nuts tightness - inspect		●		●		●		●	210

## 126 MAINTENANCE AND ADJUSTMENT

### 3. Periodic Replacement

Change/Replacement Items	Frequency	*Odometer Reading km × 1 000 (mile × 1 000)					See Page
	Whichever comes first ↓ Every	1 (0.6)	12 (7.5)	24 (15)	36 (22.5)	48 (30)	
Air cleaner element - replace # (e)	every 18 000 km (11 250 mile)						145
<b>K</b> Engine oil - change #	year	●	●	●	●	●	131
<b>K</b> Oil filter - replace	year	●	●	●	●	●	131
<b>K</b> Fuel hoses - replace	5 years						–
<b>K</b> Coolant - change	3 years				●		139
<b>K</b> Radiator hoses and O-rings - replace	3 years				●		–
<b>K</b> Brake hoses - replace	4 years						–
<b>K</b> Brake fluid (front and rear) - change	2 years			●		●	168

Change/Replacement Items	Frequency	Whichever comes first → *Odometer Reading km × 1 000 (mile × 1 000)					See Page
	Every	1 (0.6)	12 (7.5)	24 (15)	36 (22.5)	48 (30)	
<b>K</b> Rubber parts of master cylinder and caliper - replace	4 years					●	–
Spark plug - replace (e)			●	●	●	●	140



## Engine Oil

In order for the engine, transmission, and clutch to function properly, maintain the engine oil at the proper level, and change the oil and replace the oil filter in accordance with the Periodic Maintenance Chart. Not only do dirt and metal particles collect in the oil, but the oil itself loses its lubricative quality if used too long.

### **WARNING**

**Motorcycle operation with insufficient, deteriorated, or contaminated engine oil will cause accelerated wear and may result in engine or transmission seizure, accident, and injury. Check the oil level before each ride and change the oil according to the periodic maintenance chart in the Owner's Manual.**

### *Oil Level Inspection*

- If the oil has just been changed, start the engine and run it for several minutes at idle speed. This fills the oil filter with oil. Stop the engine, then wait several minutes until the oil settles.

### ***NOTICE***

**Racing the engine before the oil reaches every part can cause engine seizure.**

- If the motorcycle has just been used, wait several minutes for all the oil to drain down.

- Check the engine oil level through the oil level inspection window. With the motorcycle held level, the oil level should come up between the upper and lower level lines next to the inspection window.

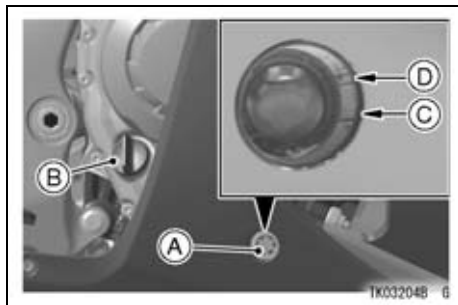

- A. Oil Level Inspection Window**
- B. Oil Filler Cap**
- C. Lower Level Line**
- D. Upper Level Line**

- If the oil level is too high, remove the excess oil through the oil filler opening using a syringe or some other suitable device.
- If the oil level is too low, add the oil to reach the correct level. Use the same type and brand of oil that is already in the engine.

**NOTICE**

If the engine oil gets extremely low or if the oil pump does not function properly or oil passages are clogged, the warning indicator light in the meter instrument and oil pressure warning symbol (  ) in the multi-function meter will go on. If they go on when the engine speed is above idle, stop the engine immediately and have it serviced. Failure to do so could cause serious engine damage.

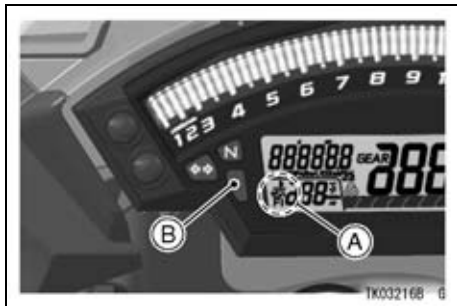

- A. Oil Pressure Warning Symbol (  )
- B. Warning Indicator Light (Red)

*Oil and/or Oil Filter Change*

- To change the engine oil and replace oil filter, the engine oil drain bolt and oil filter must be removed. The oil change and oil filter replacement should be done by an authorized Kawasaki dealer.

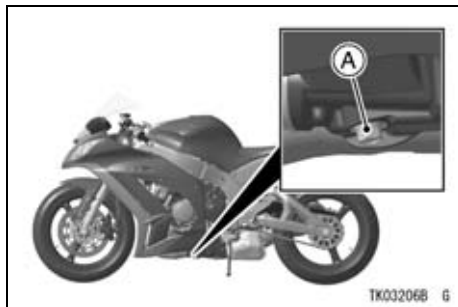

A. Engine Oil Drain Bolt

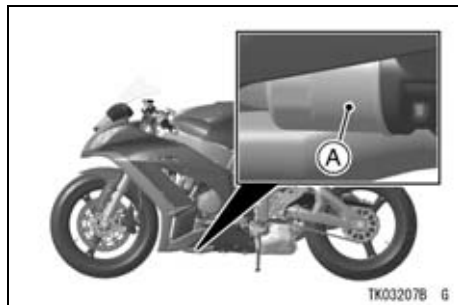

A. Oil Filter

**⚠ WARNING**

Engine oil is a toxic substance. Dispose of used oil properly. Contact your local authorities for approved disposal methods or possible recycling.

## 132 MAINTENANCE AND ADJUSTMENT

### Tightening Torque

Engine Oil Drain Bolt:

29 N·m (3.0 kgf·m, 21 ft·lb)

Oil Filter:

17 N·m (1.7 kgf·m, 13 ft·lb)

### Recommended Engine Oil

Type:

Kawasaki Performance 4-Stroke  
Motorcycle Oil\*

Kawasaki Performance 4-Stroke  
Semi-Synthetic Oil\*

Kawasaki Performance 4-Stroke Full  
Synthetic Oil\*

or other 4-stroke oils with API SG, SH,  
SJ, SL, SM and JASO MA, MA1, MA2  
rating

Viscosity:

SAE10W-40

\*Kawasaki Performance Oils and Lubricants have been specifically engineered for your vehicle. Consistent

use of these products meets or exceeds warranty and service requirements and can help to extend the life of your Kawasaki.

### NOTE

- *Do not add any chemical additive to the oil. Oils fulfilling the above requirements are fully formulated and provide adequate lubrication for both the engine and the clutch.*

### Engine Oil Capacity

Capacity:

2.9 L (3.1 US qt)

[when filter is not removed]

3.3 L (3.5 US qt)

[when filter is removed]

3.7 L (3.9 US qt)

[when engine is completely dry]

Although 10W-40 engine oil is the recommended oil for most conditions, the oil viscosity may need to be changed to accommodate atmospheric conditions in your riding area.

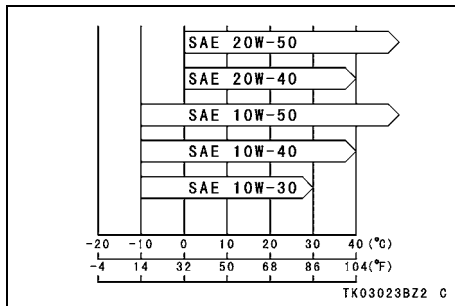

## Cooling System

### Radiator and Cooling Fan -

Check the radiator fins for obstruction by insects or mud. Clean off any obstructions with a stream of low-pressure water.

### WARNING

**The cooling fan spins at high speed and can cause serious injuries. Keep your hands and clothing away from the cooling fan blades at all times.**

**NOTICE**

**Using high-pressure water, as from a car wash facility, could damage the radiator fins and impair the radiator's effectiveness. Do not obstruct or deflect airflow through the radiator by installing unauthorized accessories in front of the radiator or behind the cooling fan. Interference with the radiator airflow can lead to overheating and consequent engine damage.**

**Radiator Hoses -**

Check the radiator hoses for leakage, cracks or deterioration, and connections for leakage, or looseness each day before riding the motorcycle, and carry out the maintenance and adjustments in accordance with the Periodic Maintenance Chart.

**Coolant -**

Coolant absorbs excessive heat from the engine and transfers it to the air at the radiator. If the coolant level becomes low, the engine overheats and may suffer severe damage. Check the coolant level each day before riding the motorcycle, also carry out the maintenance and adjustments in accordance with the periodic maintenance chart. Replenish coolant if the level is low. Change the coolant in accordance with the Periodic Maintenance Chart.

*Information for Coolant*

To protect the cooling system (consisting of the aluminum engine and radiator) from rust and corrosion, the use of corrosion and rust inhibitor chemicals in the coolant is essential. If coolant containing corrosion and rust inhibitor chemicals are not used, over a period of time, the cooling system

accumulates rust and scale in the water jacket and radiator. This will clog up the coolant passages, and considerably reduce the efficiency of the cooling system.

 **WARNING**

**Coolant containing corrosion inhibitors for aluminum engines and radiators include harmful chemicals for human body. Drinking coolant can result in serious injury or death. Use coolant in accordance with the instructions of the manufacturer.**

Soft or distilled water must be used with the antifreeze (see below for antifreeze) in the cooling system.

**NOTICE**

**If hard water is used in the system, it causes scale accumulation in the water passages, and considerably reduces the efficiency of the cooling system.**

If the lowest ambient temperature encountered falls below the freezing point of water, use permanent antifreeze in the coolant to protect the cooling system against engine and radiator freeze-up, as well as from rust and corrosion.

Use a permanent type of antifreeze (soft water and ethylene glycol plus corrosion and rust inhibitor chemicals for aluminum engines and radiators) in the cooling system. On the mixture ratio of coolant, choose the suitable one referring to the relation between freezing point and strength directed on the container.



**NOTICE**

Permanent types of antifreeze on the market have anti-corrosion and anti-rust properties. When it is diluted excessively, it loses its anti-corrosion property. Dilute a permanent type of antifreeze in accordance with the instructions of the manufacturer.

**NOTE**

- A permanent type of antifreeze is installed in the cooling system when shipped. It is colored green and contains ethylene glycol. It is mixed at 50% and has the freezing point of  $-35^{\circ}\text{C}$  ( $-31^{\circ}\text{F}$ ).

*Coolant Level Inspection*

- Situate the motorcycle so that it is perpendicular to the ground.

- Check the coolant level through the coolant level gauge on the reserve tank located to the left of the engine. The coolant level should be between the "F" (Full) and "L" (Low) level lines.

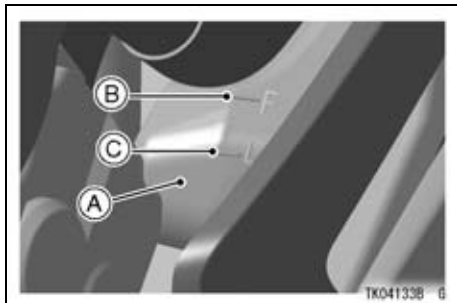

- A. Reserve Tank
- B. "F" (Full) Level Line
- C. "L" (Low) Level Line

**NOTE**

- *Check the level when the engine is cold (room or atmospheric temperature).*
- If the amount of coolant is insufficient, add coolant into the reserve tank.
- Remove the cap from the reserve tank and add coolant through the filler opening to the “F” (Full) level line.

**Coolant Filling**

- Remove the bolts and quick rivets.
- Detach the tabs and remove the right fairing and cover.

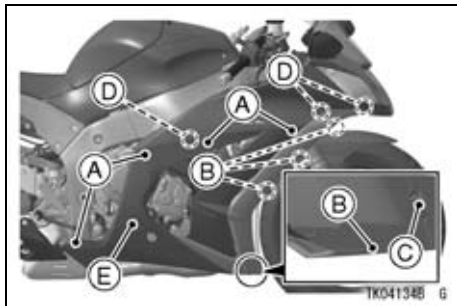

- A. Bolts
- B. Quick Rivet
- C. Large Quick Rivet
- D. Tabs
- E. Right Fairing and Cover

**NOTE**

- *The right fairing and cover uses the quick rivets and large quick rivet.*
- *The large quick rivet can be removed by pulling the center pin with a screw driver. When installing it, insert the large quick rivet into the hole on the*

## 138 MAINTENANCE AND ADJUSTMENT

*fairing and push the center pin to secure them.*

- *The quick rivets can be removed by pushing the center pin into the quick rivets, and when installing them, pull the center pin fully up first, and then push into the center pin after inserting them.*

### Quick Rivet Removal

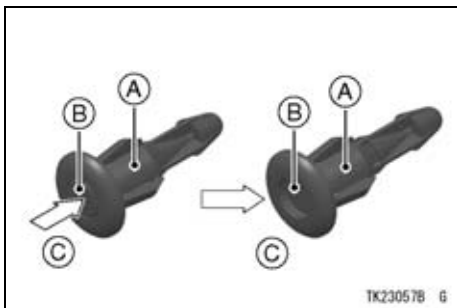

- A. Quick Rivet
- B. Center Pin
- C. Push in.

### Quick Rivet Installation

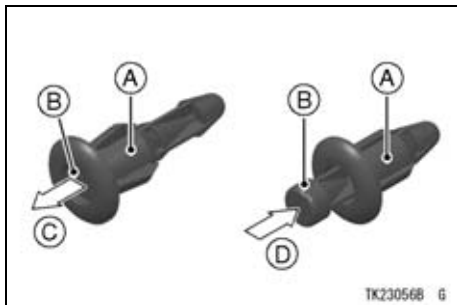

- A. Quick Rivet
- B. Center Pin
- C. Pull up fully.
- D. Push in.

- Remove the cap from the reserve tank and add coolant through the filler opening to the “F” (Full) level line.

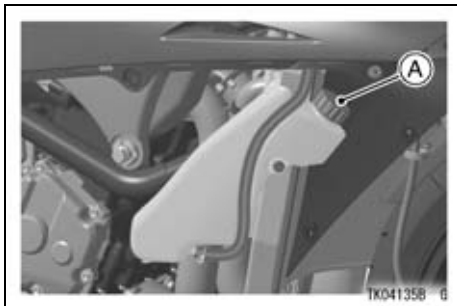

A. Reserve Tank Cap

### NOTE

- *In an emergency you can add water alone to the coolant reserve tank,*

*however, it must be returned to the correct mixture ratio by the addition of antifreeze concentrate as soon as possible.*

### NOTICE

**If coolant must be added often, or the reserve tank completely runs dry, there is probably leakage in the system. Have the cooling system inspected by your authorized Kawasaki dealer.**

### *Coolant Change*

Have the coolant changed by an authorized Kawasaki dealer.

## 140 MAINTENANCE AND ADJUSTMENT

### Spark Plugs

The standard spark plug is shown in the table. The spark plugs should be replaced in accordance with the Periodic Maintenance Chart.

Spark plug removal should be done only by a competent mechanic following the instructions in the Service Manual.

#### Spark Plug

Standard Plug:	NGK CR9EIA-9
Plug Gap:	0.8 ~ 0.9 mm (0.032 ~ 0.036 in.)
Tightening Torque:	13 N·m (1.3 kgf·m, 115 in·lb)

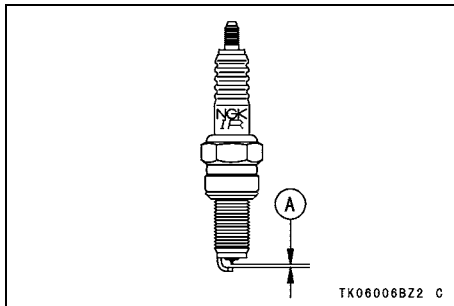

**A. Plug Gap**

## Evaporative Emission Control System (California model only)

This system routes fuel vapors from the fuel system into the running engine or stores the vapors in a canister when the engine is stopped. Although no adjustments are required, a thorough visual inspection must be made at the intervals specified by the Periodic Maintenance Chart.

### *Inspection*

- Check that the hoses are securely connected.
- Replace any kinked, deteriorated, or damaged hoses.

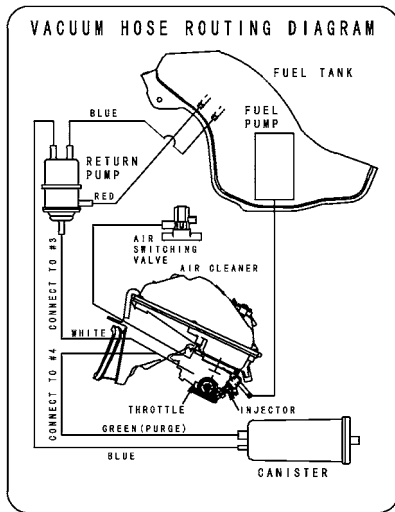

59465-0096

TE03828CN7 C

## Valve Clearance

Valve and valve seat wear decreases valve clearance, upsetting valve timing.

### ***NOTICE***

**If valve clearance is left unadjusted, wear will eventually cause the valves to remain partly open; which lowers performance, burns the valves and valve seats, and may cause serious engine damage.**

Valve clearance for each valve should be checked and adjusted in accordance with the Periodic Maintenance Chart.

Inspection and adjustment should be carried out only by a competent mechanic following the instructions in the Service Manual.

## **Kawasaki Clean Air System**

The Kawasaki Clean Air System (KCA) is a secondary air suction system that helps the exhaust gases to burn more completely. When the spent fuel charge is released into the exhaust system, it is still hot enough to burn. The KCA System allows extra air into the exhaust system so that the spent fuel charge can continue to burn. This continued burning action tends to burn up a great deal of the normally unburned gases, as well as changing a significant portion of the carbon monoxide into carbon dioxide.

### **Air Suction Valves -**

The air suction valve is essentially a check valve which allows fresh air to flow only from the air cleaner into the exhaust port. Any air that has passed

the air suction valve is prevented from returning. Inspect the air suction valves in accordance with the Periodic Maintenance Chart. Also, inspect the air suction valves whenever stable idling cannot be obtained, engine power is greatly reduced, or there are abnormal engine noises.

Air suction valve removal and inspection should be carried out only by a competent mechanic following the instructions in the Service Manual.



### Exhaust Device

This motorcycle is equipped with a exhaust device system. This system controls the valve in the exhaust pipe and produces stable engine power at low and middle engine speed. This exhaust device is controlled by the ECU, and adjustment or maintenance should be done only by a competent mechanic following the instructions in the Service Manual.



**A. Exhaust Device Cables**

### ***NOTICE***

**Do not adjust the exhaust device system by yourself. The mal-adjustment will cause the poor engine performance and engine damage.**

## Air Cleaner

A clogged air cleaner restricts the engine's air intake, increasing fuel consumption, reducing engine power, and causing spark plug fouling.

This motorcycle's air cleaner element consists of a wet paper filter, which cannot be cleaned.

The air cleaner element must be replaced in accordance with the Periodic Maintenance Chart. In dusty, rainy, or muddy conditions, the air cleaner element should be serviced more frequently than the recommended interval.

## ***NOTICE***

**Use only the recommended air cleaner element (Kawasaki part number 11013-0041). Using the other air cleaner elements will wear the engine prematurely or lower the engine performance.**

## 146 MAINTENANCE AND ADJUSTMENT

- Remove the rider's seat (see Seats section in the General Information chapter).
- Remove the bolts on the left and right fuel tank side covers.

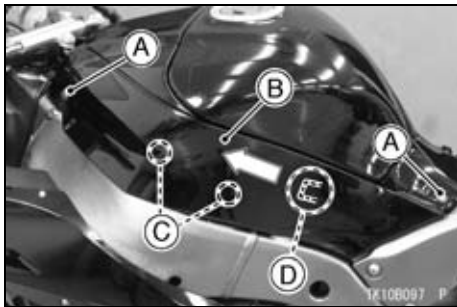

- A. Bolts
- B. Fuel Tank Side Cover
- C. Projections
- D. Tab

- Detach the projection by pulling the front of the covers outward carefully.
- Slide the covers forward to clear the tab from the slot and remove the fuel tank side covers.

### NOTE

- *On the left fuel tank side cover, pulling out it without disconnecting the connectors from the relay box.*

- Remove the bolts and fuel tank front cover.

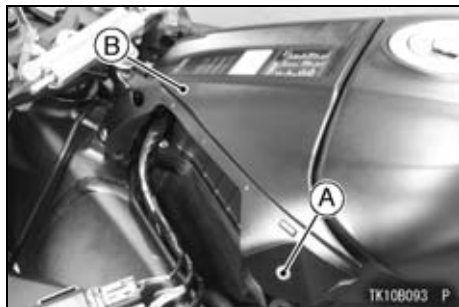

**A. Bolts**  
**B. Fuel Tank Front Cover**

- Remove the fuel tank mounting bolts.
- Disconnect the connector from the sensor on the air cleaner housing cover.

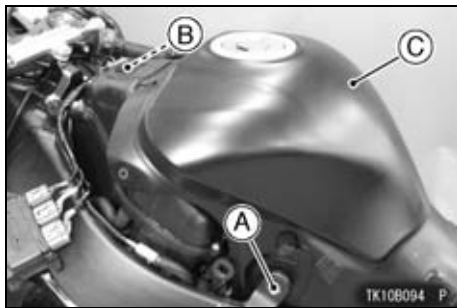

**A. Bolts**  
**B. Connector**  
**C. Fuel Tank**

- Raise the front of the fuel tank and disconnect the breather tubes from the fuel tank.
- Support the fuel tank with a suitable tool carefully.

## 148 MAINTENANCE AND ADJUSTMENT

- Detach the connector brackets at the rear of the air cleaner housing.
- Remove the screws and lift the air cleaner housing cover with the harness and fuel hoses installed.

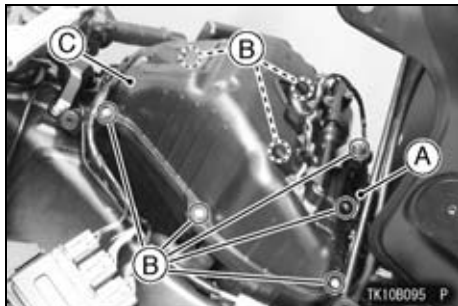

- A. Connector Brackets
- B. Screws
- C. Air Cleaner Housing Cover

- Pull out the air cleaner element.



A. Air Cleaner Element

- Put a clean, lint-free towel over the air cleaner duct and housing to keep dirt or other foreign material from entering.

**⚠ WARNING**

If dirt or dust is allowed to pass through into the fuel injection system, the throttle may stick or become inoperable resulting in a hazardous operating condition.

**NOTICE**

If dirt gets through into the engine, excessive engine wear and possibly engine damage will occur.

- Element and fuel tank installation is performed in the reverse order of removal.

*Oil Draining*

- Inspect the transparent hose located on the left side of the engine to see if any oil or water has run down from the air cleaner housing.

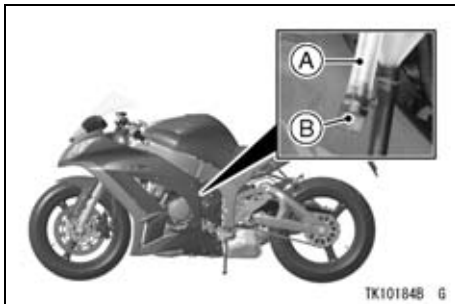

- A. Transparent Hose
- B. Plug

## 150 MAINTENANCE AND ADJUSTMENT

- If there is any oil or water in the hose, remove the plug and drain the oil or water.

### **WARNING**

**Oil on tires will make them slippery and can cause an accident and injury. Be sure to install the plug in the drain hose after draining.**

## **Throttle Control System**

Check the throttle grip play each day before riding the motorcycle, and carry out maintenance and adjustments in accordance with the Periodic Maintenance Chart. Adjust it if necessary.

### **Throttle Grip -**

The throttle grip controls the butterfly valves in the throttle body. If the throttle grip has excessive play due to either cable stretch or maladjustment, it will cause a delay in throttle response, especially at low engine speed. Also, the throttle valve may not open fully at full throttle. On the other hand, if the throttle grip has no play, the throttle will be hard to control, and the idle speed will be erratic.

*Inspection*

- Check that the throttle grip play is correct by lightly turning the throttle grip back and forth.

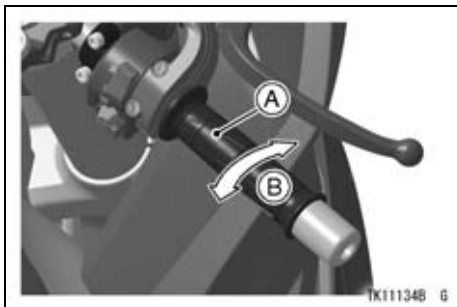

- A. Throttle Grip
- B. Throttle Grip Play

**Throttle Grip Play**

2 ~ 3 mm (0.08 ~ 0.12 in.)

- If there is improper play, adjust it.

*Adjustment*

- Loosen the locknuts at the upper of the throttle cables, and screw both throttle cable adjusters completely so as to give the throttle grip plenty of play.
- Turn out the decelerator cable adjuster until it has no play when the throttle grip is completely closed. Tighten the locknut.



## 152 MAINTENANCE AND ADJUSTMENT

- Turn out the accelerator cable adjuster until the throttle grip has the proper play. Tighten the locknut.

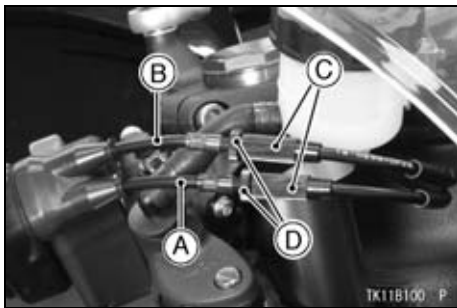

- A. Decelerator Cable
- B. Accelerator Cable
- C. Adjuster
- D. Locknuts

- If the throttle cables cannot be adjusted with the adjuster at the upper of the throttle cable, further adjustment of the throttle cables should be

done only by a competent mechanic following the instructions in the Service Manual.

- With the engine idling, turn the handlebar to each side. If handlebar movement changes the idle speed, the throttle cables may be improperly adjusted or incorrectly routed, or they may be damaged. Be sure to correct any of these conditions before idling.

### **⚠ WARNING**

**Operation with improperly adjusted, incorrectly routed, or damaged cables could result in an unsafe riding condition. Be sure the control cables are adjusted and routed correctly, and are free from damage.**

## Engine Vacuum Synchronization

Engine vacuum synchronization must be checked and adjusted periodically in accordance with the Periodic Maintenance Chart by an authorized Kawasaki dealer.

### NOTE

- *Poor engine vacuum synchronization will cause unstable idling, sluggish throttle response, and reduce engine power and performance.*

## Idle Speed

The idle speed inspection should be performed in accordance with the Periodic Maintenance Chart.

This motorcycle is equipped with the Idle Speed Control valve. If the idle speed is disturbed, inspection of the idle speed control should be done by an authorized Kawasaki dealer.

### NOTE

- *While the engine is cold, the fast idle system automatically raises the engine idling speed.*

## Idle Speed

1 050 ~ 1 150 r/min (rpm)
---------------------------

## 154 MAINTENANCE AND ADJUSTMENT

### Clutch

Due to friction plate wear and clutch cable stretch over a long period of use, the clutch operation should be checked each day before riding the motorcycle, and must be adjusted in accordance with the Periodic Maintenance Chart.

#### *Inspection*

- Check that the clutch lever operates properly and that the inner cable slides smoothly. If there is any irregularity, have the clutch cable checked by an authorized Kawasaki dealer.

- Check the clutch lever play as shown in the figure.

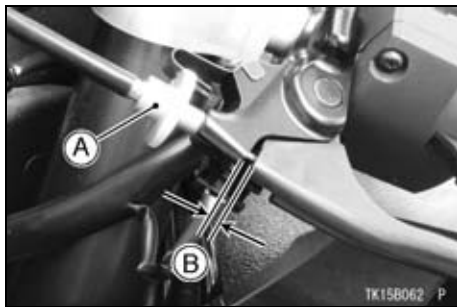

- A. Adjuster**
- B. Clutch Lever Play**

#### **Clutch Lever Play**

2 ~ 3 mm (0.08 ~ 0.12 in.)
----------------------------

If the play is incorrect, adjust the lever play as follows.

### Adjustment

- Turn the adjuster so that the clutch lever will have the proper play.

#### **WARNING**

Excess clutch cable play could prevent clutch disengagement and cause a crash resulting in serious injury or death. When adjusting the clutch cable, be sure the upper end of the outer cable is fully seated in its fitting so that it doesn't slip into place later and create excessive cable play.

- If it cannot be done, have the clutch cable adjusted by an authorized Kawasaki dealer.

#### **WARNING**

The engine and exhaust system get extremely hot during normal operation and can cause serious burns. Never touch a hot engine or an exhaust pipe during clutch adjustment.

#### **NOTE**

- *After the adjustment is made, start the engine and check that the clutch does not slip and releases properly.*
- *For minor corrections, use the adjuster at the clutch lever.*

 **DANGER**

Exhaust gas contains carbon monoxide, a colorless, odorless poisonous gas. Inhaling carbon monoxide can cause serious brain injury or death. **DO NOT** run the engine in enclosed areas. Operate only in a well-ventilated area.

## Drive Chain

The drive chain slack and lubrication must be checked each day before riding the motorcycle and must be maintained in accordance with the Periodic Maintenance Chart for safety and to prevent excessive wear. If the chain becomes badly worn or maladjusted - either too loose or too tight - the chain could jump off the sprockets or break.

 **WARNING**

A chain that breaks or jumps off the sprockets could snag on the engine sprocket or lock the rear wheel, severely damaging the motorcycle and causing it to go out of control. Inspect the chain for damage and proper adjustment before each ride.

### Chain Slack Inspection

- Set the motorcycle up on its side stand.
- Rotate the rear wheel to find the position where the chain is tightest, and measure the maximum chain slack by pulling up and pushing down the chain midway between the engine sprocket and rear wheel sprocket.

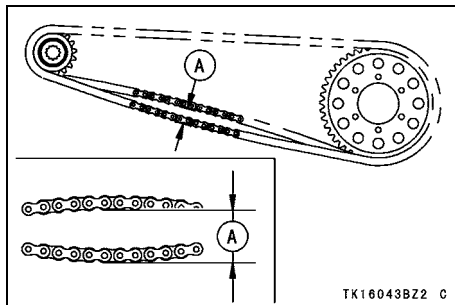

A. Chain Slack

- If the drive chain is too tight or too loose, adjust it so that the chain slack will be within the standard value.

### Drive Chain Slack

Standard: 25 ~ 35 mm (1.0 ~ 1.4 in.)

### Chain Slack Adjustment

- Remove the cotter pin, and loosen the axle nut.

## 158 MAINTENANCE AND ADJUSTMENT

- Loosen the left and right chain adjuster locknuts.

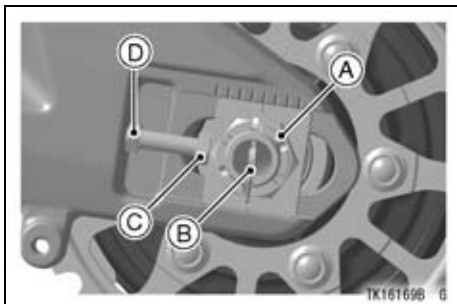

- A. Axle Nut
- B. Cotter Pin
- C. Adjuster
- D. Locknut

- If the chain is too loose, turn out the left and right chain adjusters evenly.
- If the chain is too tight, turn in the left and right chain adjusters evenly.

- Turn out both chain adjusters evenly until the drive chain has the correct amount of slack. To keep the chain and wheel properly aligned, the notch on the left wheel alignment indicator should align with the same swingarm mark that the right indicator notch aligns with.

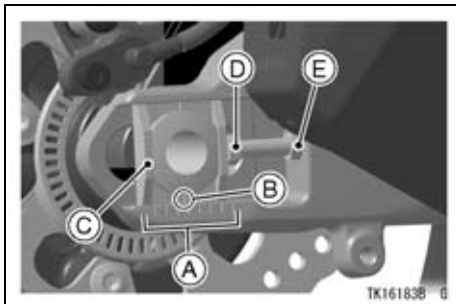

- A. Marks
- B. Notch
- C. Indicator
- D. Adjuster
- E. Locknut

## NOTE

- *Wheel alignment can also be checked using the straightedge or string method.*

## **⚠** WARNING

**Misalignment of the wheel will result in abnormal wear, and may result in an unsafe riding condition. Align the rear wheel using the marks on the swingarm or measuring the distance between the center of the axle and swingarm pivot.**

- Tighten both chain adjuster locknuts.
- Tighten the axle nut to the specified torque.



## 160 MAINTENANCE AND ADJUSTMENT

### Tightening Torque

Axle Nut:

127 N·m (13.0 kgf·m, 93.7 ft·lb)

### NOTE

- If a torque wrench is not available, this item should be serviced by an authorized Kawasaki dealer.
- Rotate the wheel, measure the chain slack again at the tightest position, and readjust if necessary.

- Install a new cotter pin through the axle nut and axle, and spread its ends.

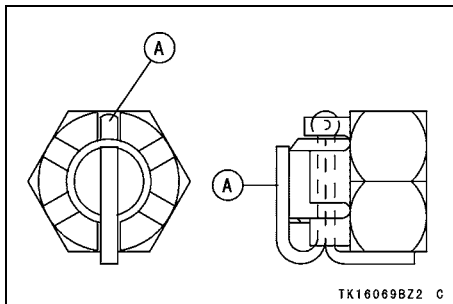

A. Cotter Pin

### NOTE

- When inserting the cotter pin, if the slots in the nut do not align with the cotter pin hole in the axle shaft, tighten the nut clockwise up to the next alignment.
- It should be within 30 degrees.

- Loosen once and tighten again when the slot goes past the nearest hole.

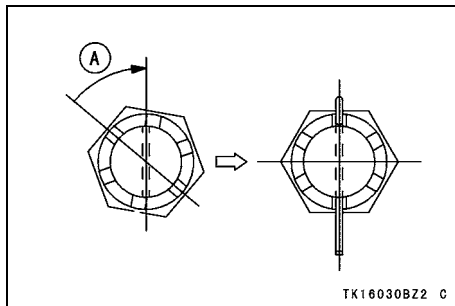

A. Turn Clockwise

## **⚠ WARNING**

A loose axle nut can lead to an accident resulting in serious injury or death. Tighten the axle nut to the proper torque and install a new cotter pin.

- Check the rear brake (see Brakes section in this chapter).

### *Wear Inspection*

- Remove the left front footpeg bracket bolts.

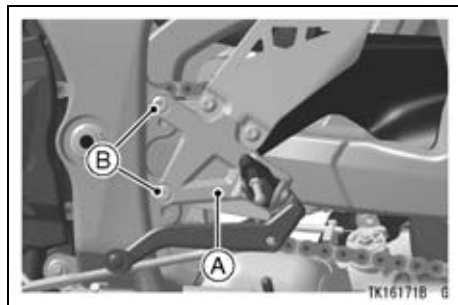

- A. Front Footpeg Bracket
- B. Bolts

## 162 MAINTENANCE AND ADJUSTMENT

- Remove the bolts and chain cover.

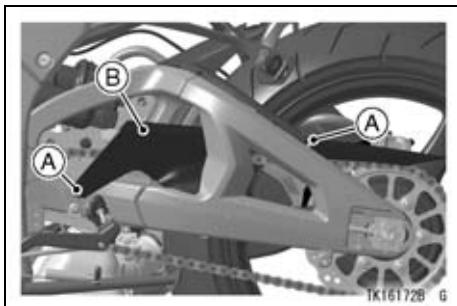

- A. Bolts
- B. Chain Cover

- Stretch the chain taut either by using the chain adjusters, or by hanging a 10 kg (22 lb) weight on the chain.
- Measure the length of 20 links on the straight part of the chain from the pin center of the 1st pin to the pin center of the 21st pin. Since the chain may wear unevenly, take measurements at several places.

- If the length exceeds the service limit, the chain should be replaced.

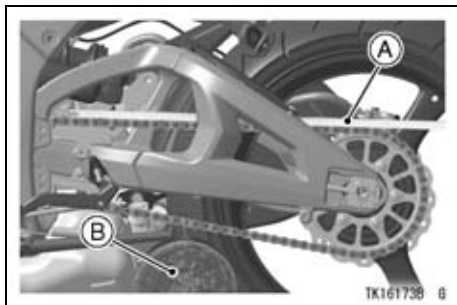

- A. Measure
- B. Weight

### *Drive Chain 20-Link Length*

Service Limit:

319 mm (12.56 in.)

**NOTE**

- *Install the chain cover and front footpeg bracket in the reverse order of removal.*
- *Reinstall the left footpeg bracket so that both footpegs are same position.*
- *Apply the nonpermanent locking agent to the chain cover front side bolt.*

**Tightening Torque**

Front Footpeg Bracket Bolts:  
25 N·m (2.5 kgf·m, 18 ft·lb)

 **WARNING**

**For safety, use only the standard chain. It is an endless type and should not be cut for installation; have it installed by an authorized Kawasaki dealer.**

- Rotate the rear wheel to inspect the drive chain for damaged rollers, and loose pins and links.
- Also inspect the sprockets for unevenly or excessively worn teeth, and damaged teeth.

**NOTE**

- *Sprocket wear is exaggerated for illustration. See Service Manual for wear limits.*

## 164 MAINTENANCE AND ADJUSTMENT

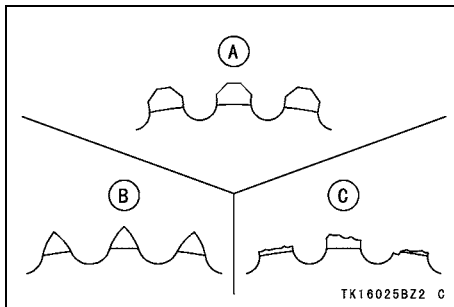

- A. Good Teeth
- B. Worn Teeth
- C. Damaged Teeth

- If there is any irregularity, have the drive chain and/or the sprockets replaced by an authorized Kawasaki dealer.

### *Lubrication*

Lubrication is necessary after riding through rain or on wet roads, or any time that the chain appears dry.

Use a lubricant for sealed chains to prevent deterioration of chain seals. If the chain is especially dirty, clean it using a cleaner for sealed chains following the instructions supplied by the chain cleaner manufacturer.

- Apply lubricant to the sides of the rollers so that it will penetrate to the rollers and bushings. Apply lubricant to the seals so that the seals will be coated with lubricant. Wipe off any excess lubricant.

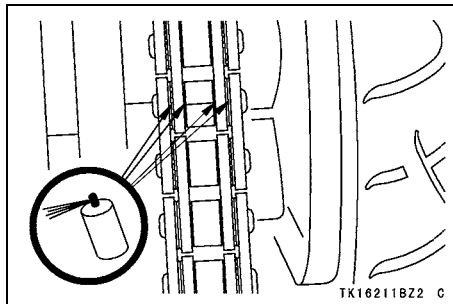

- Wipe off any lubricant that gets on the tire surface.

## Brakes

### *Brake Wear Inspection*

Inspect the brakes for wear. For each front and rear disc brake caliper, if the thickness of either pad is less than 1 mm (0.04 in.), replace both pads in the caliper as a set. Pad replacement should be done by an authorized Kawasaki dealer.

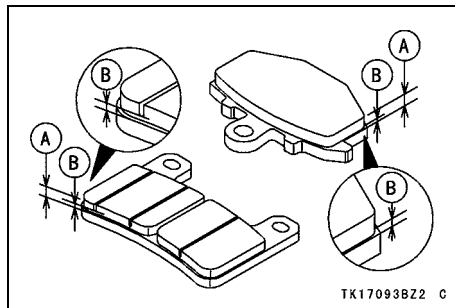

**A. Lining Thickness**

**B. 1 mm (0.04 in.)**

## Brake Fluid -

In accordance with the Periodic Maintenance Chart, inspect the brake fluid level in both the front and rear brake fluid reservoirs and change the brake fluid. The brake fluid should also be changed if it becomes contaminated with dirt or water.

### *Fluid Requirement*

Use heavy-duty brake fluid only from a container marked DOT4.

## **NOTICE**

**Do not spill brake fluid onto any painted surface.**

**Do not use fluid from a container that has been left open or that has been unsealed for a long time.**

**Check for fluid leakage around the fittings.**

**Check brake hose for damage.**

### *Fluid Level Inspection*

- With the brake fluid reservoirs held horizontal, the brake fluid level must be kept between the upper and lower level lines.

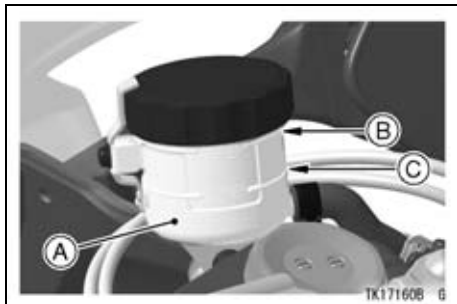

- A. Front Brake Fluid Reservoir  
B. Upper Level Line  
C. Lower Level Line

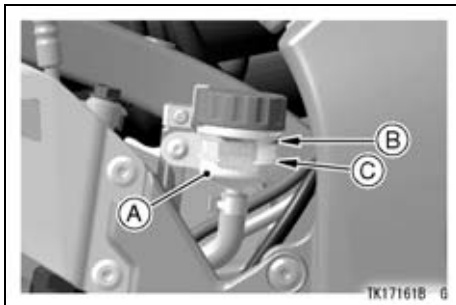

- A. Rear Brake Fluid Reservoir
- B. Upper Level Line
- C. Lower Level Line

- If the fluid level in either reservoir is lower than the lower level line, check for fluid leaks in the brake lines, and fill the reservoir to the upper level line.

## **⚠ WARNING**

Mixing brands and types of brake fluid can reduce the brake system's effectiveness and cause an accident resulting in injury or death. Do not mix two brands of brake fluid. Change the brake fluid in the brake line completely if the brake fluid must be refilled but the type and brand of the brake fluid that is already in the reservoir are unidentified.

## **NOTE**

- *First, tighten until slight resistance is felt, which indicates that the cap is seated on the reservoir body, and tighten the cap an additional 1/6 turn while holding the brake fluid reservoir body.*





- A. Reservoir
- B. Cap
- C. Clockwise
- D. 1/6 turn

### *Fluid Change*

Have the brake fluid changed by an authorized Kawasaki dealer.

### **Front and Rear Brakes -**

Disc and disc pad wear is automatically compensated for and has no effect on the brake lever or pedal action. So there are no parts that require adjustment on the front and rear brakes.

### **⚠ WARNING**

**Air in the brake lines diminish braking performance and can cause an accident resulting in injury or death. If the brake lever or pedal feels mushy when it is applied, there might be air in the brake lines or the brake may be defective. Have the brake checked immediately by an authorized Kawasaki dealer.**

## Brake Light Switches

When either the front or rear brake is applied, the brake light goes on. The front brake light switch requires no adjustment, but the rear brake light switch should be adjusted in accordance with the Periodic Maintenance Chart.

### Inspection

- Turn the ignition key to “ON”.
- The brake light should go on when the front brake is applied.
- If it does not, ask an authorized Kawasaki dealer to inspect the front brake light switch.

- Check the operation of the rear brake light switch by depressing the brake pedal. The brake light should go on after the proper pedal travel.

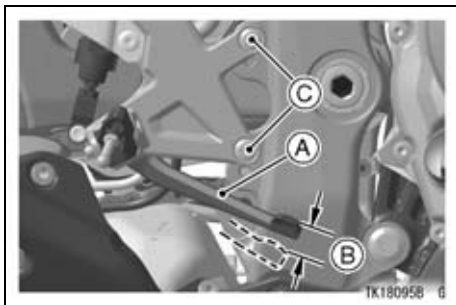

- A. Brake Pedal
- B. 10 mm (0.4 in.)
- C. Bolts

- If it does not, adjust the rear brake light switch.

### Brake Pedal Travel

10 mm (0.4 in.)

## 170 MAINTENANCE AND ADJUSTMENT

### *Adjustment*

- Remove the right front footpeg bracket bolts.
- Pull the front footpeg bracket a little bit outward.
- To adjust the rear brake light switch, move the switch up or down by turning the adjusting nut.

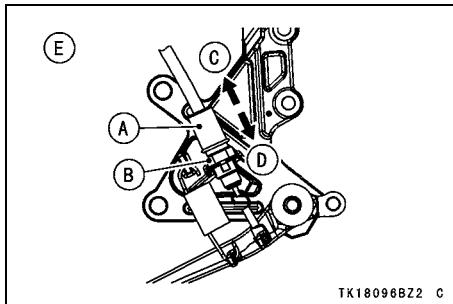

- A. Rear Brake Light Switch
- B. Adjusting Nut
- C. Lights sooner
- D. Lights later
- E. Viewed from behind the bracket

### **NOTICE**

To avoid damaging the electrical connections inside the switch, be sure that the switch body does not turn during adjustment.

**NOTE**

- *Install the front footpegs with same height on both sides. Refer to the Front Footpeg Position in General Information chapter.*

**Electronic Steering Damper**

This motorcycle is equipped with an electronic steering damper unit.

The steering operation should be checked and the electronic steering damper unit should be inspected for oil leakage each day before riding, and the maintenance must be carried out in accordance with the Periodic Maintenance Chart.

### Front Fork

The front fork operation and oil leakage should be checked in accordance with the Periodic Maintenance Chart.

For various riding or load conditions the front fork can be adjusted for:

- Spring preload
- Rebound damping force
- Compression damping force

#### **⚠ WARNING**

**Improper fork leg adjustment can cause poor handling and loss of stability, which could lead to an accident. Always adjust the fork legs on the left and right side to the same setting.**

### *Front Fork Inspection*

- Holding the brake lever, pump the front fork up and down several times to inspect smooth stroke.
- Visually inspect the front fork for oil leakage, scoring or scratches on the outer surface of the inner tube.
- If any doubt about the front fork, it should be checked by an authorized Kawasaki dealer.

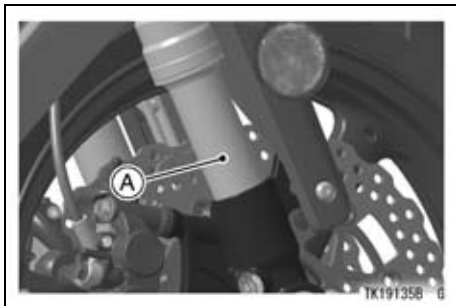

**A. Inner Tube**

### *Spring Preload Adjustment*

The spring preload adjuster is located at the lower end of each front fork leg and can be adjusted.

- To increase spring preload and stiffen the suspension, turn the preload adjuster clockwise with a hexagon wrench.

- To decrease preload and soften the suspension, turn the preload adjuster counterclockwise.

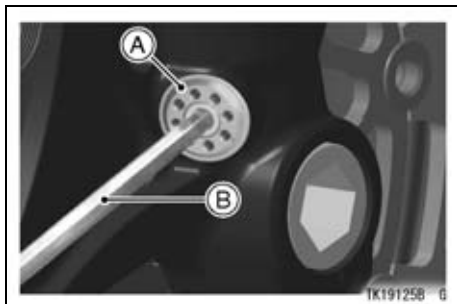

**A. Spring Preload Adjuster**

**B. Hexagon Wrench**

## 174 MAINTENANCE AND ADJUSTMENT

### Spring Preload Setting

Adjuster Position	0*	← <b>6 turns in**</b> →	15 turns in**
Spring Action	Weak	← <b>Standard</b> →	Strong
Setting	Soft	← <b>Standard</b> →	Hard
Load	Light	← <b>Standard</b> →	Heavy
Road	Good	← <b>Standard</b> →	Bad
Speed	Low	← <b>Standard</b> →	High

\*: This position is the fully seated position (turned fully counterclockwise).

\*\* : In from the fully seated position (turned fully counterclockwise). This adjustment range may not exactly match the number shown in the table due to small tolerance of production.

### *Compression Damping Force Adjuster and Rebound Damping Force Adjuster Adjustment*

The compression damping force adjuster and the rebound damping force adjuster are located on top of each front fork leg.

- Turn the adjuster clockwise with a screwdriver to increase damping force.
- Turn the adjuster counterclockwise to decrease damping force.

### **NOTICE**

**Do not force to turn the rebound and compression damping force adjuster from the fully seated position, or the adjusting mechanism may be damaged.**

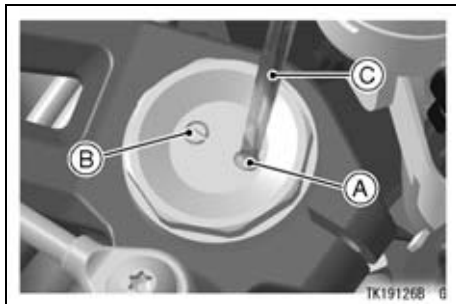

- A. Compression Damping Force Adjuster (COM)
- B. Rebound Damping Force Adjuster (TEN)
- C. Screwdriver



## 176 MAINTENANCE AND ADJUSTMENT

### Compression Damping Force Setting and Rebound Damping Force Setting

Adjuster Position	Compression Damping	0*	← <b>4 1/2 turns out**</b> →	7 turns out**
	Rebound Damping	0*	← <b>3 3/4 turns out**</b> →	5 1/2 turns out**
Damping Force		Strong	← <b>Standard</b> →	Weak
Setting		Hard	← <b>Standard</b> →	Soft
Load		Heavy	← <b>Standard</b> →	Light
Road		Bad	← <b>Standard</b> →	Good
Speed		High	← <b>Standard</b> →	Low

\*: This position is the fully seated position (turned fully clockwise).

\*\* : Out from the fully seated position (turned fully clockwise). This adjustment range may not exactly match the number shown in the table due to small tolerance of production.

The standard front fork setting positions are as follows:

**Standard Setting Position (Front Fork)**

Spring Preload Adjuster	<b>6 turns in*</b>
Compression Damping Adjuster	<b>4 1/2 turns out**</b>
Rebound Damping Adjuster	<b>3 3/4 turns out**</b>

\*: In from the fully seated position (turned fully counterclockwise)

\*\* : Out from the fully seated position (turned fully clockwise)

## Rear Shock Absorber

The rear shock absorber should be checked for operation and oil leakage in accordance with the Periodic Maintenance Chart.

For various riding or load conditions the rear shock absorber can be adjusted for:

- Spring preload
- Rebound damping force
- Compression damping force

### *Rear Shock Absorber Inspection*

- Press down on the seat several times to inspect the stroke.
- Visually inspect the rear shock absorber for oil leaks.

- If there is any doubt about the rear shock absorber, it should be inspected by an authorized Kawasaki dealer.

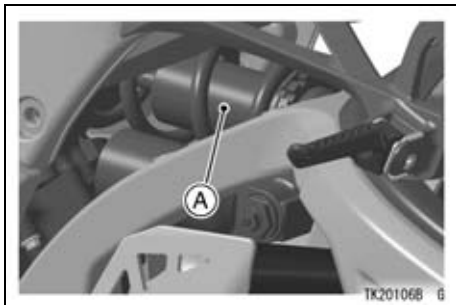

**A. Rear Shock Absorber**

### *Spring Preload Adjustment*

The spring adjusting nut on the rear shock absorber can be adjusted.

If the spring action feels too soft or too stiff, have it adjusted by an authorized Kawasaki dealer.

### Rebound Damping Force Adjustment

The rebound damping force adjuster is located at the upper end of the rear shock absorber.

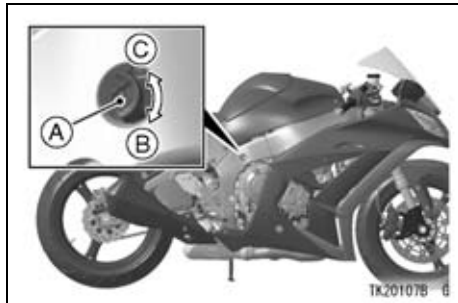

- A. Rebound Damping Force Adjuster
- B. To increase damping force
- C. To decrease damping force

- Using a screwdriver turn the rebound damping force adjuster clockwise to increase rebound damping or anti-clockwise to decrease it.

### ***NOTICE***

**Do not turn the rebound damping force adjuster beyond the fully seated position or the adjusting mechanism may be damaged.**

## 180 MAINTENANCE AND ADJUSTMENT

### Rebound Damping Force Setting

Adjuster Position	0*	← <b>1 3/4 turns out**</b> →	3 turns out**
Damping Force	Strong	← <b>Standard</b> →	Weak
Setting	Hard	← <b>Standard</b> →	Soft
Load	Heavy	← <b>Standard</b> →	Light
Road	Bad	← <b>Standard</b> →	Good
Speed	High	← <b>Standard</b> →	Low

\*: This position is the fully seated position (turned fully clockwise).

\*\* : Out from the fully seated position (turned fully clockwise). This adjustment range may not exactly match the number shown in the table due to small tolerance of production.

### *Compression Damping Force Adjustment*

The compression damping force adjusters for high and low speeds are located on the gas reservoir at the left side of the rear shock absorber.

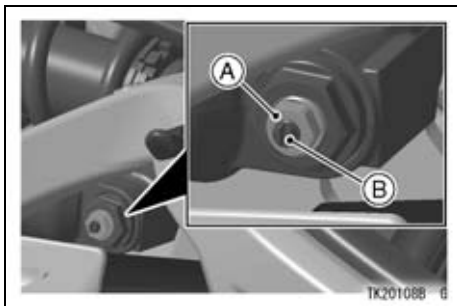

**A. High Speed Adjuster**  
**B. Low Speed Adjuster**

### **NOTE**

- *Turning the high speed adjuster has the low speed adjuster turning. Although the low speed adjuster turns with the high speed adjuster when turning the high speed adjuster, the low speed adjuster setting position does not change.*

### *Low Speed Compression Damping Adjustment*

- Using a screwdriver turn the low speed compression adjuster screw clockwise to increase damping force or counterclockwise to decrease it.

### *High Speed Compression Damping Adjustment*

- Turn the high speed compression damping force adjuster clockwise to increase damping force or counterclockwise to decrease it.

***NOTICE***

Do not turn the compression damping force adjuster beyond the fully seated position or the adjusting mechanism may be damaged.

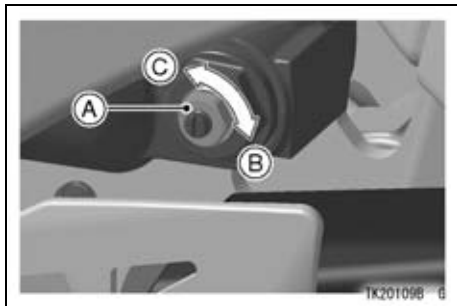

- A. Compression Damping Force Adjuster for High Speed
- B. To increase damping force
- C. To decrease damping force

**Compression Damping Force Setting for High and Low Speeds**

Adjuster Positions	High Speed	0*	← <b>1 3/4 turns out**</b> →	5 turns out**
	Low Speed	0*	← <b>1 3/4 turns out**</b> →	5 turns out**
Damping Force		Strong	← <b>Standard</b> →	Weak
Setting		Hard	← <b>Standard</b> →	Soft
Load		Heavy	← <b>Standard</b> →	Light
Road		Bad	← <b>Standard</b> →	Good
Speed		High	← <b>Standard</b> →	Low

\*: This position is the fully seated position (turned fully clockwise).

\*\* : Out from the fully seated position (turned fully clockwise). This adjustment range may not exactly match the number shown in the table due to small tolerance of production.



## 184 MAINTENANCE AND ADJUSTMENT

The standard suspension setting positions are as follows:

### Standard Setting Position (Rear Shock Absorber)

Rebound Damping Adjuster		<b>1 3/4 turns out*</b>
Compression Damping Adjuster	High Speed	<b>1 3/4 turns out*</b>
	Low Speed	<b>1 3/4 turns out*</b>

\*: Out from the fully seated position (turned fully clockwise)

## Wheels

Tubeless tires are installed on the wheels of this motorcycle. The indications of “TUBELESS” on the tire side wall and the rim show that the tire and rim are specially designed for tubeless use.

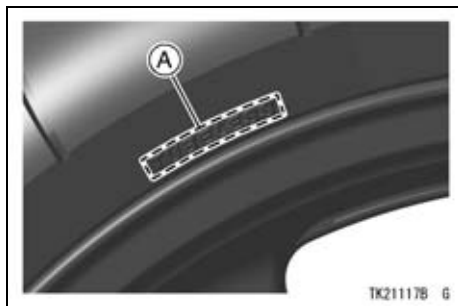

A. “TUBELESS” Mark

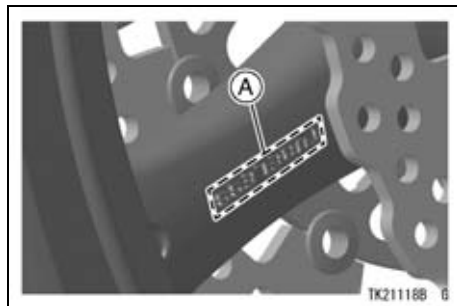

A. “TUBELESS” Mark

The tire and rim form a leakproof unit by making airtight contacts at the tire chamfers and the rim flanges instead of using an inner tube.

 **WARNING**

Installing a tube inside a tubeless-type tire can create excessive heat build up that can damage the tube and cause rapid deflation. The tires, rims, and air valves on this motorcycle are designed only for tubeless type wheels. The recommended standard tires, rims, and air valves must be used for replacement. Do not install tube-type tires on tubeless rims. The beads may not seat properly on the rim causing tire deflation. Do not install a tube inside a tubeless tire. Excessive heat build-up may damage the tube causing tire deflation.

**Tires -***Payload and Tire Pressure*

Failure to maintain proper inflation pressures or observe payload limits for your tires may adversely affect handling and performance of your motorcycle and can result in loss of control. The maximum recommended load in addition to vehicle weight is 180 kg (397 lb), including rider, passenger, baggage, and accessories.

- Remove the air valve cap.
- Check the tire pressure often, using an accurate gauge.
- Make sure to install the air valve cap securely.

**NOTE**

○ *Measure the tire pressure when the tires are cold (that is, when the motorcycle has not been ridden more than a mile during the past 3 hours).*

- *Tire pressure is affected by changes in ambient temperature and altitude, and so the tire pressure should be checked and adjusted when your riding involves wide variations in temperature or altitude.*

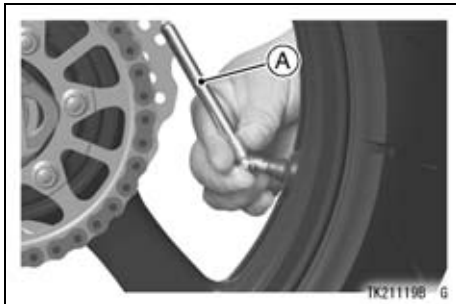

**A. Tire Pressure Gauge**

### **Tire Air Pressure (when cold)**

Front	250 kPa (2.50 kgf/cm <sup>2</sup> , 36 psi)
Rear	290 kPa (2.90 kgf/cm <sup>2</sup> , 42 psi)

### *Tire Wear, Damage*

As the tire tread wears down, the tire becomes more susceptible to puncture and failure. An accepted estimate is that 90% of all tire failures occur during the last 10% of tread life (90% worn). So it is false economy and unsafe to use the tires until they are bald.

- In accordance with the Periodic Maintenance Chart, measure the depth of the tread with a depth gauge, and replace any tire that has worn down to the minimum allowable tread depth.

## 188 MAINTENANCE AND ADJUSTMENT



A. Tire Depth Gauge

### Minimum Tread Depth

Front	—	1 mm (0.04 in.)
Rear	Under 130 km/h (80 mph)	2 mm (0.08 in.)
	Over 130 km/h (80 mph)	3 mm (0.12 in.)

- Visually inspect the tire for cracks and cuts, replacing the tire in case of bad damage. Swelling or high spots indicate internal damage, requiring tire replacement.
- Remove any imbedded stones or other foreign particles from the tread.

### NOTE

- *Have the wheel balance inspected whenever a new tire is installed.*

**⚠ WARNING**

Tires that have been punctured and repaired do not have the same capabilities as undamaged tires and can suddenly fail, causing an accident resulting in serious injury or death. Replace damaged tires as soon as possible. To ensure safe handling and stability, use only the recommended standard tires for replacement, inflated to the standard pressure. If it is necessary to ride on a repaired tire, do not exceed 100 km/h (60 mph) until the tire is replaced.

**NOTE**

- *When operating on public roadways, keep maximum speed under traffic law limits.*

**Standard Tire (Tubeless)**

Front	120/70ZR17 M/C (58W) ● BRIDGESTONE BATTLAX BT016F CC
Rear	190/55ZR17 M/C (75W) ● BRIDGESTONE BATTLAX BT016R CC

**⚠ WARNING**

Some replacement tires may adversely affect handling and cause an accident resulting in serious injury or death. To ensure proper handling and stability, use only the recommended standard tires for replacement, inflated to the standard pressure.

 **WARNING**

**New tires are slippery and may cause loss of control and injury. A break-in period of 160 km (100 miles) is necessary to establish normal tire traction. During break-in, avoid sudden and maximum braking and acceleration, and hard cornering.**

## **Battery**

The battery installed in this motorcycle is a sealed type, so it is not necessary to check the battery electrolyte level or add distilled water.

The sealing strip should not be pulled off once the specified electrolyte has been installed in the battery for initial service.

However, in order to maximize battery life and ensure that it will provide the power needed to start the motorcycle you must properly maintain the battery's charge. When used regularly, the charging system in the motorcycle helps keep the battery fully charged. If your motorcycle is only used occasionally or for short periods of time, the battery is more likely to discharge.

Due to their internal composition, batteries continually self discharge. The discharge rate depends on the type of battery and ambient temperature. As temperature rises, so does the discharge rate. Every 15°C (59°F) doubles the rate.

Electrical accessories, such as digital clocks and computer memory, also draw current from the battery even when the key is switched off. Due to a combination of such “key-off” draws and hot temperature, a battery can go from fully charged to completely discharged in a matter of days.

Self-discharge		
Temperature	Approx. number of days from 100% charged to 100% discharged	
	Lead -Antimony	Lead -Calcium
	Battery	Battery
40°C (104°F)	100 Days	300 Days
25°C (77°F)	200 Days	600 Days
0°C (32°F)	550 Days	950 Days



Current Drain		
Discharging Ampere	Days from 100% charged to 50% discharged	Days from 100% charged to 100% discharged
7 mA	60 Days	119 Days
10 mA	42 Days	83 Days
15 mA	28 Days	56 Days
20 mA	21 Days	42 Days
30 mA	14 Days	28 Days

In extremely cold weather the fluid in an inadequately charged battery can easily freeze, which can crack the case and buckle the plates. A fully charged battery can withstand sub-freezing temperature with no damage.

### Battery Sulfation

A common cause of battery failure is sulfation.

Sulfation occurs when the battery is left in a discharged condition for an extended time. Sulfate is a normal by product of the chemical reactions within a battery. But when continuous discharge allows the sulfate to crystallize in the cells, the battery plates become permanently damaged and will not hold a charge. Battery failure due to sulfation is not warrantable.

### Battery Maintenance

It is the owner's responsibility to keep the battery fully charged. Failure to do so can lead to battery failure and leave you stranded.

If you are riding your vehicle infrequently, inspect the battery voltage weekly using a voltmeter. If it drops below 12.8 volts, the battery should be charged using an appropriate charger (check with your Kawasaki dealer).

If you will not be using the motorcycle for longer than two weeks, the battery should be charged using an appropriate charger. Do not use an automotive-type quick charger that may overcharge the battery and damage it.

### NOTE

- *Leaving the battery connected causes the electrical components (clock etc) to make the battery discharged, resulting the over discharge of the battery. In this case, the repair or replacement of the battery is not included in the warranty. If you do not drive for four weeks or more, disconnect the battery from the vehicle.*

### **Kawasaki-recommended chargers are:**

Battery Mate 150-9  
OptiMate 4

Yuasa MB-2040/2060  
Christie C10122S

If the above chargers are not available, use equivalent one.

For more details, ask your Kawasaki dealer.

### **Battery Charging**

- Remove the battery from the motorcycle (see Battery Removal).
- Attach the leads from the charger and charge the battery at a rate (amperage x hours) that is indicated on the battery. If it is not possible to read the rate, charge the battery at an amperage that is about 1/10th of the battery capacity.
- The charger will keep the battery fully charged until you are ready to re-install the battery in the motorcycle (see Battery Installation).

**NOTICE**

Never remove the sealing strip, or the battery can be damaged. Do not install a conventional battery in this motorcycle, or the electrical system cannot work properly.

Make	Yuasa Battery
Type	ZX1000J: YTZ7S (F) ZX1000K: YTZ10S

**NOTE**

- *If you charge the sealed battery, never fail to observe the instructions shown in the label on the battery.*

**⚠ WARNING**

Battery posts, terminals and related accessories contain lead and lead compounds, chemicals known to the State of California to cause cancer and reproductive harm. Wash hands after handling.

**Battery Removal**

- Remove the rider's seat (see Seats section in the GENERAL INFORMATION chapter).
- Turn the ignition switch to "OFF" and disconnect the (-) cable from the battery.
- Remove the red cap from the (+) terminal, and disconnect the (+) cables from the battery.

**NOTE**

- The battery is different in the model equipped with KIBS and the model without KIBS. The (+) terminal and (-) terminal are right and left reversed.

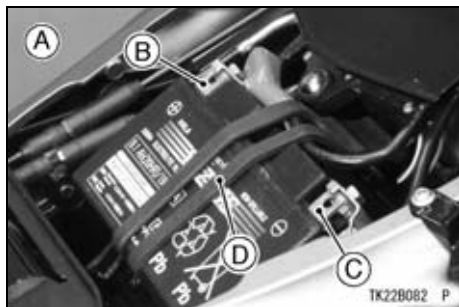

- A. For models equipped with KIBS  
 B. (+) Terminal  
 C. (-) Terminal  
 D. Rubber Band

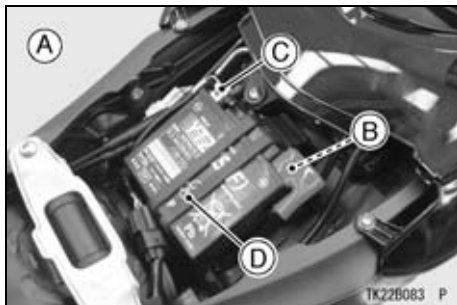

- A. For models without KIBS  
 B. (+) Terminal  
 C. (-) Terminal  
 D. Rubber Band

- Unlock the rubber band.
- Take the battery out of the case.
- Be sure that the cable connections are clean.

*Battery Installation*

- Place the battery in the battery case.

## 196 MAINTENANCE AND ADJUSTMENT

- Connect the (+) cable to the (+) terminal, and then connect the (-) cable to the (-) terminal.

### **NOTICE**

**Installing the (-) cable to the (+) terminal of the battery or the (+) cable to the (-) terminal of the battery can seriously damaged the electrical system.**

- Put a light coat of grease on the terminals to prevent corrosion.
- Cover the (+) terminal with the red cap.
- Reinstall the removed parts.

## Headlight Beam

### **NOTE**

- *Do not turn the bolts because the reflector in the headlight comes off.*

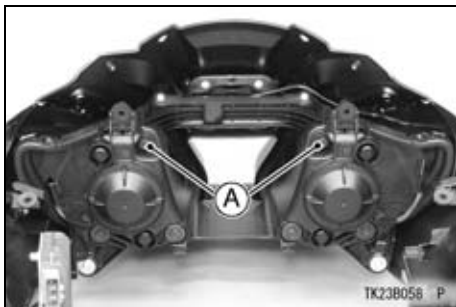

### **A. Bolts**

- The left and right adjusters on the headlight can move the direction of the headlight beam to up, down, left and right by turning each adjuster itself as the below table.

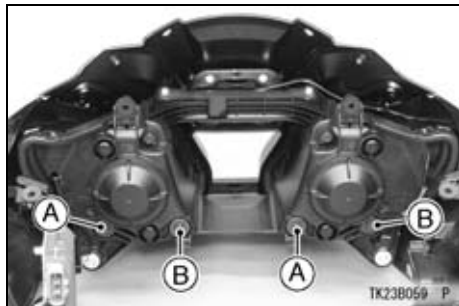

**A. Left Adjuster**  
**B. Right Adjuster**

	Turning Direction of Adjuster	Moving Direction of Headlight Beam
Left Adjuster	Clockwise	Left and Down
	Counter-clockwise	Right and Up
Right Adjuster	Clockwise	Right and Down
	Counter-clockwise	Left and Up

- To move the headlight beam leftward, turn the left adjuster clockwise and turn the right adjuster counter-clockwise same number as the left adjuster was turned until the beam points straight ahead.

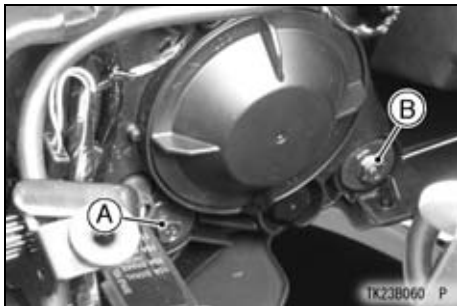

A. Left Adjuster  
B. Right Adjuster

- To move the headlight beam rightward, turn the left adjuster counterclockwise and turn the right adjuster clockwise same number as the left adjuster was turned until the beam points straight ahead.
- If not properly adjusted horizontally, the beam will point to one side rather than straight ahead.

- To move the headlight beam upward, turn the both adjusters counterclockwise same number.
- To move the headlight beam downward, turn the both adjusters clockwise same number.
- If adjusted too low, neither low nor high beam will illuminate the road far enough ahead. If adjusted too high, the high beam will fail to illuminate the road close ahead, and the low beam will blind oncoming drivers.

### NOTE

- *On high beam, the brightest points should be slightly below horizontal. The proper angle is 0.4 degrees below horizontal. This is a 50 mm (2.0 in.) drop at 7.6 m (25 ft) measured from the center of the headlight, with the motorcycle on its wheels and the rider seated.*

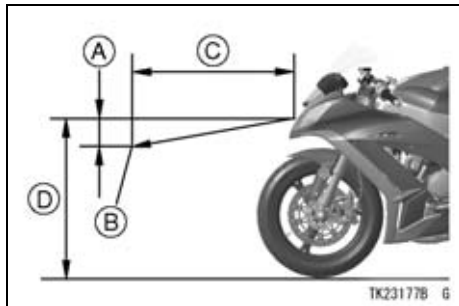

- A. 50 mm (2.0 in.)
- B. Center of Brightest Spot
- C. 7.6 m (25 ft)
- D. Height of Headlight Center

## Fuses

Fuses are arranged in the fuse boxes located under the passenger's seat and in the left fairing. The main fuse is located under the passenger's seat.

If a fuse fails during operation, inspect the electrical system to determine the cause, and then replace it with a new fuse of proper amperage.

The main fuse removal should be done by an authorized Kawasaki dealer.



## 200 MAINTENANCE AND ADJUSTMENT



**A. Fuse Box**

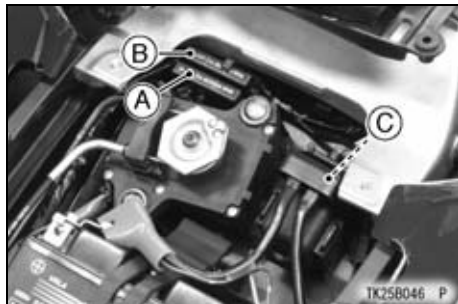

**A. Fuse Box**  
**B. Fuse Box (for models equipped with KIBS)**  
**C. Main Fuse**

**⚠ WARNING**

Substituting fuses can cause wiring to overheat, catch fire and/or fail. Do not use any substitute for the standard fuse. Replace the blown fuse with a new one of the correct capacity, as specified on the fuse box and main fuse.

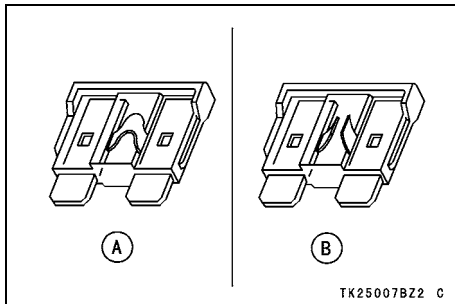

- A. Normal  
B. Failed

### General Lubrication

Lubricate the points shown below, with either motor oil or regular grease, in accordance with the Periodic Maintenance Chart or whenever the vehicle has been operated under wet or rainy conditions.

Before lubricating each part, clean off any rusty spots with rust remover and wipe off any grease, oil, dirt, or grime.

#### NOTE

- *A few drops of oil are effective to keep bolts and nuts from rusting and sticking. This makes removal easier. Badly rusted nuts, bolts, etc., should be replaced with new ones.*

### Apply motor oil to the following pivots -

- Side Stand
- Clutch Lever
- Front Brake Lever
- Rear Brake Pedal

### Lubricate the following cables with a pressure cable luber -

- (K) Clutch Inner Cable
- (K) Throttle Inner Cables

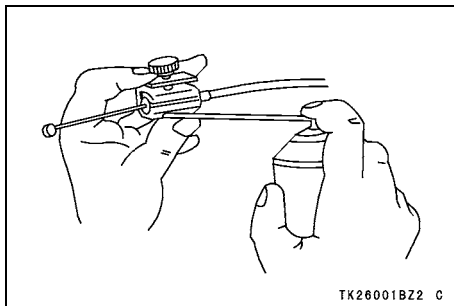

TK26001B22 C

### Apply grease to the following points -

- (K) Clutch Inner Cable Upper End
- (K) Throttle Inner Cable Upper Ends

(K): Should be serviced by an authorized Kawasaki dealer.

### NOTE

- *After connecting the cables, adjust them.*

## Cleaning Your Motorcycle

### *General Precautions*

Frequent and proper care of your Kawasaki motorcycle will enhance its appearance, optimize overall performance, and extend its useful life. Covering your motorcycle with a high quality, breathable motorcycle cover will help protect its finish from harmful UV rays, pollutants, and reduce the amount of dust reaching its surfaces.

 **WARNING**

**Build-up of debris or flammable material in and around the vehicle chassis, engine, and exhaust can cause mechanical problems and increase the risk of fire.**

**When operating the vehicle in conditions that allow debris or flammable material to collect in and around the vehicle, inspect the engine, electrical component and exhaust areas frequently. If debris or flammable materials have collected, park the vehicle outside and stop the engine. Allow the engine to cool, then remove any collected debris. Do not park or store the vehicle in an enclosed space prior to inspecting for build-up of debris or flammable materials.**

- Be sure the engine and exhaust are cool before washing.
- Avoid applying degreaser to seals, brake pads, and tires.
- Avoid all harsh chemicals, solvents, detergents, and household cleaning products such as ammonia-based window cleaners.
- Gasoline, brake fluid, and coolant will damage the finish of painted and plastic surfaces: wash them off immediately.
- Avoid wire brushes, steel wool, and all other abrasive pads or brushes.
- Use care when washing the windshield, headlight lens, and other plastic parts as they can easily be scratched.
- Avoid using pressure washers; water can penetrate seals and electrical components and damage your motorcycle.

- Avoid spraying water in delicate areas such as in air intakes, fuel system, brake components, electrical components, muffler outlets, and fuel tank openings.

### *Washing Your Motorcycle*

- Rinse your bike with cold water from a garden hose to remove any loose dirt.
- Mix a mild neutral detergent (designed for motorcycles or automobiles) and water in a bucket. Use a soft cloth or sponge to wash your motorcycle. If needed, use a mild degreaser to remove any oil or grease which build up.
- After washing, rinse your motorcycle thoroughly with clean water to remove any residue (residue from the detergent can damage parts of your motorcycle).
- Use a soft cloth to dry your motorcycle. As you dry, inspect your motorcycle for chips and scratches. Do not let the water air dry as this can damage the painted surfaces.

## 206 MAINTENANCE AND ADJUSTMENT

- After cleaning your motorcycle, check the rubber boot covering the shift pedal ball joint for correct installation. Be sure the sealing lip of the rubber boot fits into the groove of the ball joint.

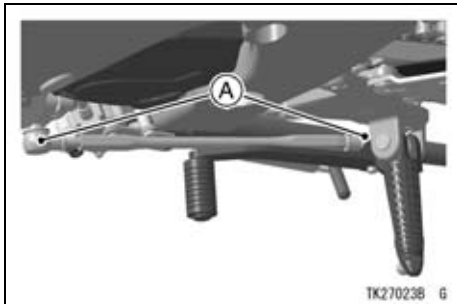

A. Boots

- If the boot is damaged, replace it with a new one. If the boot is not positioned in the groove correctly, replace it in the correct position.

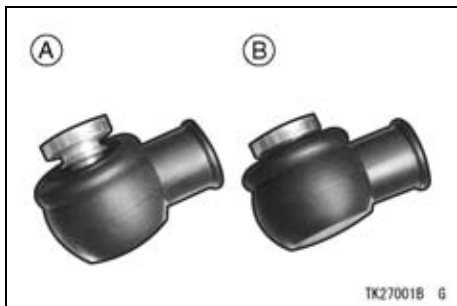

- A. Wrongly set lip not in the correct position  
B. Lip set correctly in the groove

- Start the engine and let it idle for several minutes. The heat from the engine will help dry moist areas.

- Carefully ride your motorcycle at a slow speed and apply the brakes several times. This helps the brakes dry and restores its normal operating performance.
- Lubricate the drive chain to prevent rusting.

### NOTE

- *After riding in an area where the roads are salted or near the ocean, immediately wash your motorcycle with cold water. Do not use warm water as it accelerates the chemical reaction of the salt. After drying, apply a corrosion protection spray on all metal and chrome surfaces to prevent corrosion.*
- *Condensation may form on the inside of the headlight lens after riding in the rain, washing the motorcycle or humid weather. To remove the moisture, start the engine and turn on the*

*headlight. Gradually the condensation on the inside of the lens will clear off.*

### *Semi-gloss Finish*

To clean the semi-gloss finish;

- When washing the motorcycle, always use a mild neutral detergent and water.
- The semi-gloss finish effect may be lost when the finish is excessively rubbed.
- If any doubt, consult an authorized Kawasaki dealer.

### *Windshield and Other Plastic Parts*

After washing use a soft cloth to gently dry plastic parts. When dry, treat the windshield, headlight lens, and other nonpainted plastic parts with an approved plastic cleaner/polisher product.



**NOTICE**

**Plastic parts may deteriorate and break if they come in contact with chemical substances or household cleaning products such as gasoline, brake fluid, window cleaners, thread-locking agents, or other harsh chemicals. If a plastic part comes in contact with any harsh chemical substance, wash it off immediately with water and a mild neutral detergent, and then inspect for damage. Avoid using abrasive pads or brushes to clean plastic parts, as they will damage the part's finish.**

*Chrome and Aluminum*

Chrome and uncoated aluminum parts can be treated with a chrome/aluminum polish. Coated aluminum

should be washed with a mild neutral detergent and finished with a spray polish. Aluminum wheels, both painted and unpainted can be cleaned with special non-acid based wheel spray cleaners.

*Leather, Vinyl, and Rubber*

If your motorcycle has leather accessories, special care must be taken. Use a leather cleaner/treatment to clean and care for leather accessories. Washing leather parts with detergent and water will damage them, shortening their life.

Vinyl parts should be washed with the rest of the motorcycle, then treated with a vinyl treatment.

The sidewalls of tires and other rubber components should be treated with a rubber protectant to help prolong their useful life.

 **WARNING**

Rubber protectants can be slippery and, if used on the tread area, cause loss of traction resulting in accident causing injury or death. Do not apply rubber protectant to any tread area.

## 210 MAINTENANCE AND ADJUSTMENT

### Bolt and Nut Tightening

In accordance with the Periodic Maintenance Chart, it is very important to check the tightness of the bolts and nuts listed here. Also, check to see that each cotter pin is in place and in good condition. Please ask your authorized Kawasaki dealer for torque values.

1. Clutch Lever Holder Bolts
2. Steering Stem Head Nut
3. Handlebar Clamp Bolts
4. Front Fork Clamp Bolts
5. Brake Lever Mounting Bolts

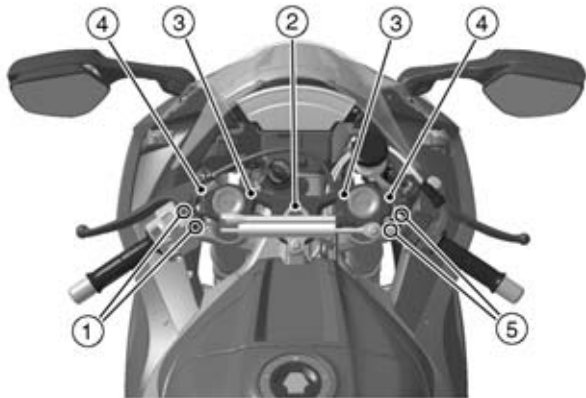

- 6. Front Fender Mounting Bolts
- 7. Engine Mounting Bolts and Nuts
- 8. Rear Frame Mounting Bolts
- 9. Brake Disc Mounting Bolts
- 10. Front Axle Clamp Bolts
- 11. Front Axle Nut
- 12. Caliper Mounting Bolts
- 13. Side Stand Bolt
- 14. Suspension Linkage Tie-Rod Nuts
- 15. Swingarm Pivot Shaft Nut
- 16. Footpeg Mounting Bolts
- 17. Rear Shock Absorber Mounting Bolts
- 18. Rear Axle Nut
- 19. Rear Sprocket Nuts

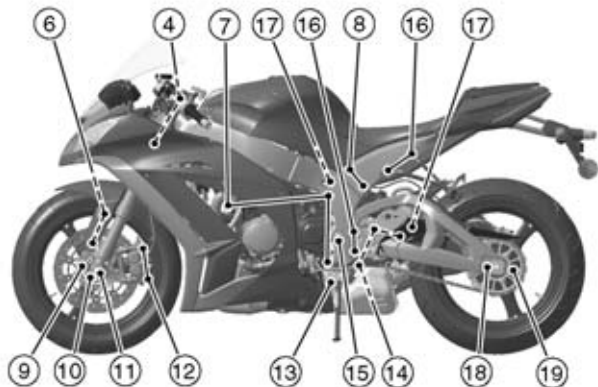

## 212 MAINTENANCE AND ADJUSTMENT

20. Silencer Mounting Bolt

21. Brake Pedal Bolt

22. Exhaust Pipe Mounting Bolt and Nuts

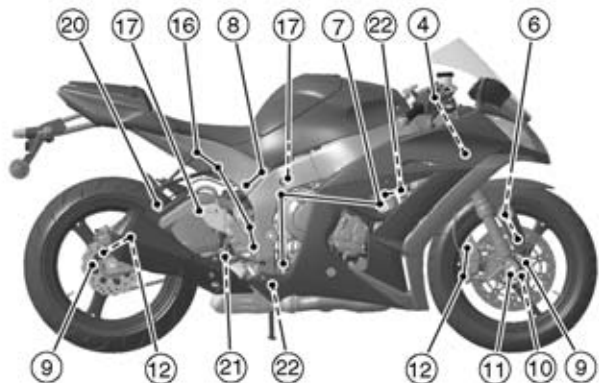

TK281148 G

---

## STORAGE

---

### Preparation for Storage

- Clean the entire vehicle thoroughly.
- Run the engine for about five minutes to warm the oil, shut it off, and drain the engine oil.



### **WARNING**

**Engine oil is a toxic substance. Dispose of used oil properly. Contact your local authorities for approved disposal methods or possible recycling.**

- Put in fresh engine oil.
- Empty the fuel from the fuel tank by the pump or siphon.

 **WARNING**

**Gasoline is extremely flammable and can be explosive under certain conditions, creating the potential for serious burns. Turn the ignition key to “OFF”. Do not smoke. Make sure the area is well-ventilated and free from any source of flame or sparks; this includes any appliance with a pilot light. Gasoline is a toxic substance. Dispose of gasoline properly. Contact your local authorities for approved disposal methods.**

- Empty the fuel system by running the engine at idle speed until the engine stalls (If left in for a long time, the fuel will break down and could clog the fuel system).
- Reduce tire pressure by about 20%.
- Set the motorcycle on a box or stand so that both wheels are raised off the ground. (If this cannot be done, put boards under the front and rear wheels to keep dampness away from the tire rubber.)
- Spray oil on all unpainted metal surfaces to prevent rusting. Avoid getting oil on rubber parts or in the brakes.
- Lubricate the drive chain and all the cables.
- Remove the battery, and store it where it will not be exposed to direct sunlight, moisture, or freezing temperature. During storage it should be given a slow charge (one ampere or less) about once a month. Keep the battery well charged especially during cold weather.
- Tie plastic bags over the mufflers to prevent moisture from entering.

- Put a cover over the motorcycle to keep dust and dirt from accumulating on it.

### **Preparation after Storage**

- Remove the plastic bags from the mufflers.
- Install the battery in the motorcycle and charge the battery if necessary.
- Fill the fuel tank with fuel.
- Check all the points listed in the Daily Checks section.
- Lubricate the pivots, bolts, and nuts.



---

## TROUBLESHOOTING GUIDE

---

### **Engine Does Not Start -**

#### *Starter Motor Won't Turn*

- Engine stop switch off
- Transmission not in neutral
- Fuse blown
- Battery leads do not make good electrical contact with battery terminals
- Battery discharged

#### *Engine Cranks, But Won't Start*

- No fuel in tank
- Fuel line clogged
- Fuel broken down
- Engine flooded
- Spark plugs not in good contact
- Spark plugs fouled or wet

- Incorrect spark plug gap
- Incorrect valve clearance
- No first turning the ignition switch to "OFF" when the motorcycle falls down.

### **Engine Stalls -**

#### *Just When Shifting Into 1st Gear*

- Side stand has been left down
- Clutch does not properly disengage

#### *While Riding*

- No fuel in tank
- Fuel tank air vent is obstructed
- Overheating
- Battery discharged

---

## YOUR WARRANTY/OWNER SATISFACTION

---

Welcome to the Kawasaki family!

Congratulations on buying your Kawasaki vehicle. You've chosen a great, high-quality product with state-of-the-art features and built to Kawasaki's high standards. Your satisfaction is important to your authorized Kawasaki dealer and to Kawasaki Motors Corp., U.S.A. Here is some important information regarding your vehicle's limited warranty.

Frequently Asked Questions

### **What is a Limited Warranty?**

The most important thing to know about your warranty is that it protects you from manufacturing defects in material or workmanship during the warranty period. You can find the warranty period in the Kawasaki Limited Warranty Certificate your Kawasaki dealer provided to you at the time of sale. The warranty does not cover the cost of regularly-scheduled maintenance. The warranty also does not apply to the normal wear of items such as tires, brake pads, transmission drive belts, chains, sprockets, etc.

## 218 YOUR WARRANTY/OWNER SATISFACTION

### **What is the Good Times Protection Plan?**

Much of the warranty coverage offered by the limited warranty can be extended by purchasing Kawasaki's Good Time™ Protection Plan (GTPP). See your Kawasaki dealer or go to [Kawasaki.com](http://Kawasaki.com) for more information if you don't already have the GTPP.

### **What Am I Responsible For?**

You are responsible for maintaining your vehicle according to the maintenance schedule shown in this owner's manual.

You are responsible for notifying your dealer immediately if there is a problem, and you, as the owner, will need to authorize the dealer to inspect the unit.

You will be responsible for paying for routine maintenance, including the first scheduled service. You can have the required servicing done by your Kawasaki dealer (recommended) or an equally-qualified service facility. You can also do your own maintenance work if you have the proper tools, service references, and mechanical skills. However, if a failure is found to be caused by improper servicing, it would not be covered by the limited warranty.

You may purchase a Kawasaki Service Manual and any necessary special tools directly from your Kawasaki dealer.

You will be responsible for paying for repairs needed because of an accident, to replace worn parts such as tires, chains, brakes, and for repairs needed because of a lack of maintenance, misuse or racing.

Whether you do it yourself or take your vehicle to a Kawasaki dealer, be sure to record your service in the Maintenance Record section of this Owner's Manual. Keep all receipts for the service and/or items necessary to perform the maintenance so that in the event of a failure you can document the service history.

### **What Are The Dealership's Responsibilities?**

Your Kawasaki dealer offers a wide range of services, parts, accessories, and information on your product and on Kawasaki.

Each dealer is independently owned and operated and is responsible for the dealership's operations, its repair, warranty, and service work, and its personnel.

## **220 YOUR WARRANTY/OWNER SATISFACTION**

Your dealer is responsible for completing the set up and pre-delivery service of your new Kawasaki vehicle. The dealership should also explain its operation, maintenance, and warranty provisions so you understand them at the time of purchase or at any other time you have questions.

The dealership is responsible for inspecting your Kawasaki vehicle if there is a failure, investigating the cause of the problem, and getting any needed authorization from Kawasaki if the repair is one that will be covered by the limited warranty. The dealership will also file all necessary paperwork. The dealership is responsible for correctly completing any necessary repairs, whether they are covered by the limited warranty or not.

### **How Do I Get Warranty Service?**

If there is a problem with your vehicle within the limited warranty period, you will need to schedule a service appointment and provide any maintenance records to an authorized Kawasaki dealer for inspection and diagnosis. You can go to any Kawasaki dealer for warranty repairs. Your Kawasaki dealer will inspect your vehicle and give you the results of the inspection. The dealer will perform the repairs at no cost to you if it is determined that the problem is covered by the warranty.

Kawasaki will work with your dealer to resolve any warranty issues. No authorization for warranty work can be given until your vehicle has been inspected by a Kawasaki dealer.

### **What if I am not Satisfied With My Warranty Service?**

If you aren't satisfied with your dealership's repair work or operations, it is best to discuss the situation with the appropriate dealership manager. If you have already done this, then contact the dealership's owner or general manager to request a review of the issue.

If you are unable to resolve a problem after consulting with the dealership management and need further assistance, contact Kawasaki Motors Corp., U.S.A. at the address below. Please be certain to provide the model, vehicle identification number (VIN), mileage or hours of use, accessories, dates that events occurred and what action has been taken by both you and your dealer. Include the name and address of the dealership. To assist us in resolving your inquiry, please include copies of related receipts and any other pertinent information including the name of the dealership personnel with whom you have been working. Upon receipt of your correspondence, Kawasaki Motors Corp., U.S.A. will contact the dealership and work with it in resolving your problem.

**Want to Contact Kawasaki?**

This owner's manual should answer most of your questions about your Kawasaki. Your Kawasaki dealer should either be able to answer any other questions you might have immediately or be able to find the answer for you.

Please send your correspondence to:

Consumer Services

Kawasaki Motors Corp., U.S.A.

P.O. Box 25252

Santa Ana, CA 92799-5252

(949) 460-5688

---

## REPORTING SAFETY DEFECTS

---

### **(For Products Sold in the United States of America, District of Columbia, and U.S. Territories Only)**

If you believe that your vehicle has a defect which could cause a crash or could cause injury or death, you should immediately inform the National Highway Traffic Safety Administration (NHTSA) in addition to notifying Kawasaki Motors Corporation, U.S.A.

If NHTSA receives similar complaints, it may open an investigation, and if it finds that a safety defect exists in a group of vehicles, it may order a recall and remedy campaign. However, NHTSA cannot become involved in individual problems between you, your dealer, or Kawasaki Motors Corporation, U.S.A.

To contact NHTSA, you may either call the Auto Safety Hotline toll-free at 1-800-424-9393 (or 366-0123 in Washington, D.C. area) or write to: NHTSA, U.S. Department of Transportation, Washington, D.C. 20590. You can also obtain other information about motor vehicle safety from the Hotline.



---

## ENVIRONMENTAL PROTECTION

---

To help preserve the environment, properly discard used batteries, tires, oils and fluids, or other vehicle components that you might dispose of in the future. Consult your authorized Kawasaki dealer or local environmental waste agency for their proper disposal procedure. This also applies to disposal of the entire vehicle at the end of its life.

---

**MAINTENANCE RECORD**

---

**Owner Name**.....

**Address** .....

**Phone Number** .....

**Engine Number** .....

**Vehicle Number**.....

**Key Code** .....

**Selling Dealer Name** .....

**Phone Number** .....

**Warranty Start Date** .....

**Note:** Keep this information and a spare key in a secure location.

Date	Odometer Reading	Maintenance Performed	Dealer Name	Dealer Address







---

## LOCATION OF LABELS

---

All warning labels which are on your vehicle are repeated here. Read labels on your vehicle and understand them thoroughly. They contain information which is important for your safety and the safety of anyone else who may operate your vehicle. Therefore, it is very important that all warning labels be on your vehicle in the locations shown. If any label is missing, damaged, or worn, get a replacement from your Kawasaki dealer and install it in the correct position.

### NOTE

- *The sample warning labels in this section have part numbers to help*

*you and your dealer obtain the correct replacement.*

- *Refer to the actual vehicle label for model specific data grayed out in the illustration.*

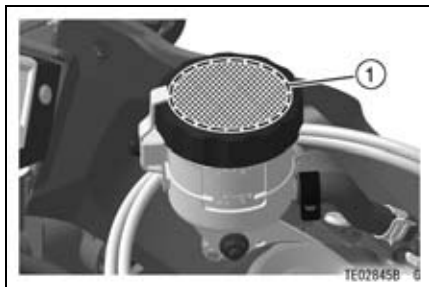

**1. Brake Fluid (Front)**

## 230 LOCATION OF LABELS

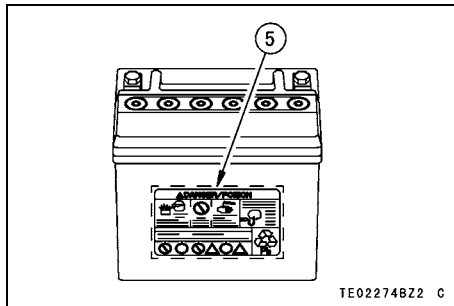
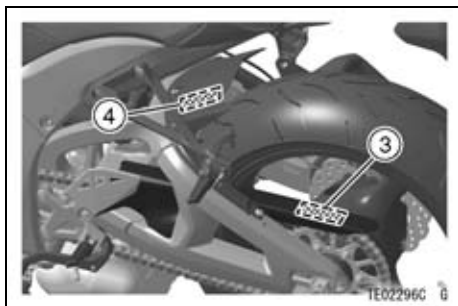

2. Brake Fluid (Rear)
3. Important Drive Chain Information
4. Tire and Load Data
5. Battery Poison/Danger

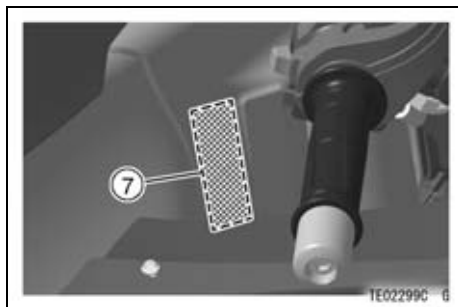
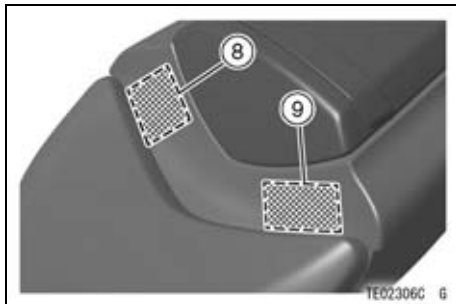
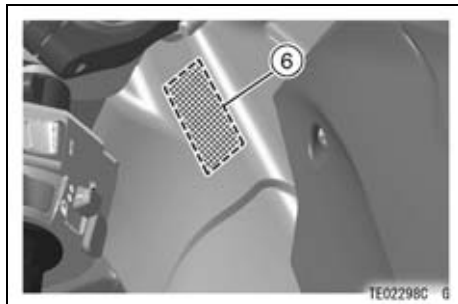

- 6. Noise Emission Control Information
- 7. Weight and Manufacture
- \*8. Vacuum Hose Routing Diagram
- 9. Vehicle Emission Control Information

\* : only on California model



## 232 LOCATION OF LABELS

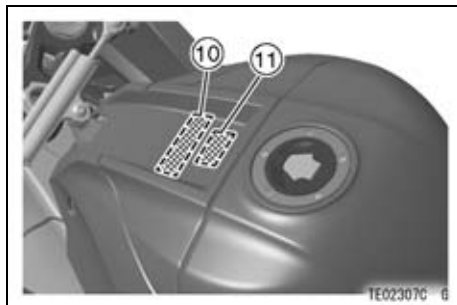

- \*10. Fuel Level
- 11. Fuel Notice

\* : only on California model

1)

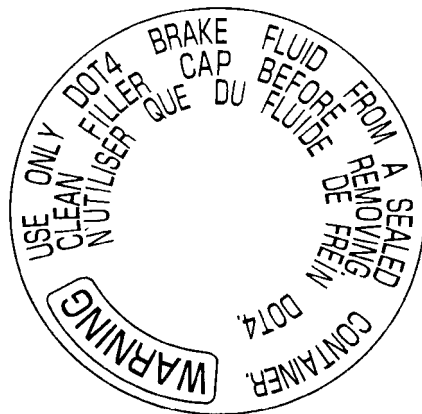

2)

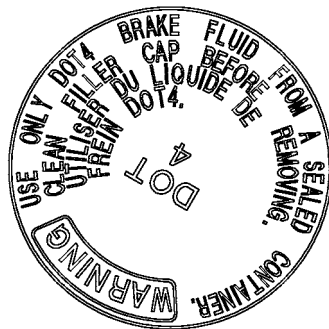

## 234 LOCATION OF LABELS

3)

### IMPORTANT DRIVE CHAIN INFORMATION

To prevent an accident and/or damage to the motorcycle, the drive chain must be properly maintained. It should be lubricated every 600km(400mi) and adjusted as often as necessary to keep chain slack at about 25~35mm(1.0~1.4in) measured midway between sprockets on the lower chain run with the motorcycle on the side stand. The standard chain is an ENUMA EK525RWX with estimated service life of 15000~45000km(9400~28000mi), depending on the severity of use and the frequency of lubrication and adjustment. For safety, replace the chain with only the standard chain any time it wears to over 319mm(12.56in), measured over a 20-link portion pulled straight with 98N(10kgf, 20lbf) of tension. See the Owner's Manual for chain information.

56033-0380

TE03818CN8 C

4)

### TIRE AND LOAD DATA

The stability and handling characteristics of this motorcycle could become unsafe by the use of improper tire inflation pressures, worn tires, unsuitable replacement tires, or overloading. When tire tread wears down to the limit, replace the tire with only the standard tire. Maintain the inflation pressure specified.

	Air pressure(Cold)	Size & Make Type (Tubeless Tire)	Minimum Tread Depth
Front	250 kPa (Up to 180 kg Load (397lbs) (2.50kg/cm <sup>2</sup> , 36psi)	BRIDGESTONE 120/70Z81M/C (58W) BATTAX BT016F CC	1 mm(0.04in)
Rear	290 kPa (2.90kg/cm <sup>2</sup> , 42psi)	BRIDGESTONE 190/55Z81M/C (75W) BATTAX BT016F CC	Up to 130 km/h(80MPH) 2 mm(0.08in) Over 130 km/h(80MPH) 3 mm(0.12in)

56053-0540

TE03819C S

5)

<b>⚠ DANGER/POISON</b>			
 <p><b>SHIELD EYES</b> EXPLOSIVE GASES CAN CAUSE BLINDNESS OR INJURY</p>	 <p><b>NO</b> • SPARKS • FLAMES • SMOKING</p>	 <p><b>SULFURIC ACID</b> CAN CAUSE BLINDNESS OR SEVERE BURNS</p>	<p><b>FLUSH EYES IMMEDIATELY WITH WATER</b></p>  <p><b>GET MEDICAL HELP FAST</b></p>
<b>KEEP OUT OF REACH OF CHILDREN</b>			<p><b>LEAD</b></p>  <p><b>RETURN</b></p> <p><b>RECYCLE</b> <b>Pb</b></p>
<p>IN U.S.A., YUASA BATTERY, INC. SERVICED BY : READING, PA. 19605</p>			
			

## 236 LOCATION OF LABELS

6)

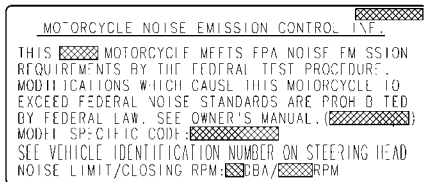

TE03304D S

7)

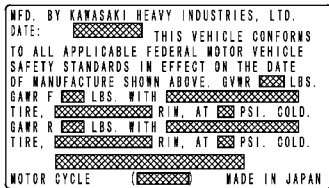

TE03303D S

8) only on California model

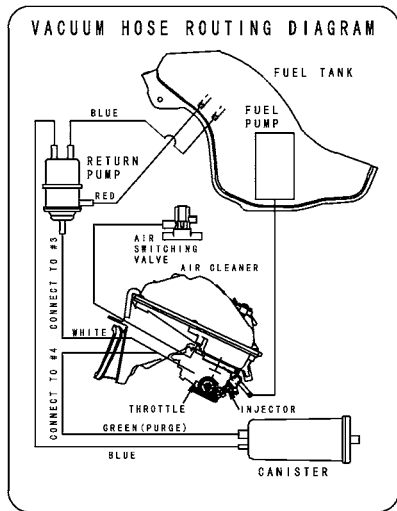

59465-0096

TE03828CN7 C

9) except California model

VEHICLE EMISSION CONTROL INFORMATION		[REDACTED]	
ENGINE FAMILY CODE	PERMANT ON FAMILY	[REDACTED]	[REDACTED]
MODEL	[REDACTED]	[REDACTED]	[REDACTED]
FORWARD EMISSION CONTROL SYSTEM	[REDACTED]	[REDACTED]	[REDACTED]
DISPLACEMENT	[REDACTED]	[REDACTED]	[REDACTED]
TYPE OF SPECIFICATION			
ENGINE TUNING	NO ADJUSTMENT	[REDACTED]	[REDACTED]
VALVE CLEARANCE	NO ADJUSTMENT	[REDACTED]	[REDACTED]
SPARK PLUG	TYPE	[REDACTED]	[REDACTED]
FUEL	CAPACITY	[REDACTED]	[REDACTED]
ENGINE OIL	SERVICE INTERVAL	[REDACTED]	[REDACTED]
	VELOCITY	[REDACTED]	[REDACTED]
THIS VEHICLE CONFORMS TO U.S. EPA REGULATIONS APPLICABLE TO [REDACTED] MODEL YEAR NEW MOTORCYCLES AND IS NOT ELIGIBLE FOR [REDACTED] EMISSION STANDARDS IN CALIFORNIA.			
[REDACTED] MOTORCYCLE PARTS DIVISION, [REDACTED] MOTORCYCLE PARTS DIVISION, LTD.			

TE03300D S

9) only on California model

VEHICLE EMISSION CONTROL INFORMATION		[REDACTED]	
ENGINE FAMILY CODE	PERMANT ON FAMILY	[REDACTED]	[REDACTED]
MODEL	[REDACTED]	[REDACTED]	[REDACTED]
FORWARD EMISSION CONTROL SYSTEM	[REDACTED]	[REDACTED]	[REDACTED]
DISPLACEMENT	[REDACTED]	[REDACTED]	[REDACTED]
TYPE OF SPECIFICATION			
ENGINE TUNING	NO ADJUSTMENT	[REDACTED]	[REDACTED]
VALVE CLEARANCE	NO ADJUSTMENT	[REDACTED]	[REDACTED]
SPARK PLUG	TYPE	[REDACTED]	[REDACTED]
FUEL	CAPACITY	[REDACTED]	[REDACTED]
ENGINE OIL	SERVICE INTERVAL	[REDACTED]	[REDACTED]
	VELOCITY	[REDACTED]	[REDACTED]
THIS VEHICLE CONFORMS TO U.S. EPA AND CALIFORNIA REGULATIONS APPLICABLE TO [REDACTED] MODEL YEAR NEW MOTORCYCLES AND IS NOT ELIGIBLE FOR [REDACTED] EMISSION STANDARDS IN CALIFORNIA.			
[REDACTED] MOTORCYCLE PARTS DIVISION, LTD.			

TE03301D S

10) only on California model

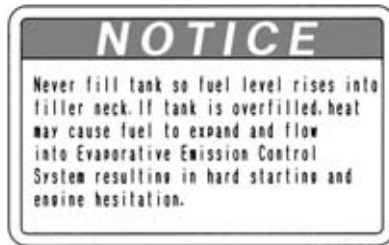

56071-0158

TE03142C S

11)

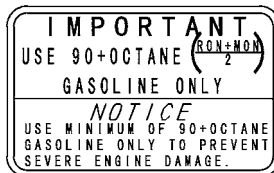

56030-0357

TE03172CN9 C

# ZX1000JF/KF



\* 9 9 9 8 7 - 1 8 3 2 \*

**Kawasaki Heavy Industries, Ltd.** Motorcycle & Engine Company

Printed in Japan

GB