

CB/CL-360

TEMPORARY SHOP MANUAL SUPPLEMENT

CAM CHAIN TENSIONER SLIPPER REPLACEMENT:

File this supplement with the CB/CL-360 Shop Manual, and refer to the following procedure when replacing the cam chain tensioner slipper.

The procedure described in this supplement supersedes the original shop manual procedure. Shop manual revisions will be supplied at a later date.

CAM CHAIN TENSIONER MECHANISM

- ① Cam Chain
- ② Upper Tensioner Slipper Holder
- ③ Upper Damper
- ④ Tensioner Slipper
- ⑤ Lower Damper
- ⑥ Tensioner Arm
- ⑦ Push Bar
- ⑧ Set Bolt
- ⑨ Chain Guide

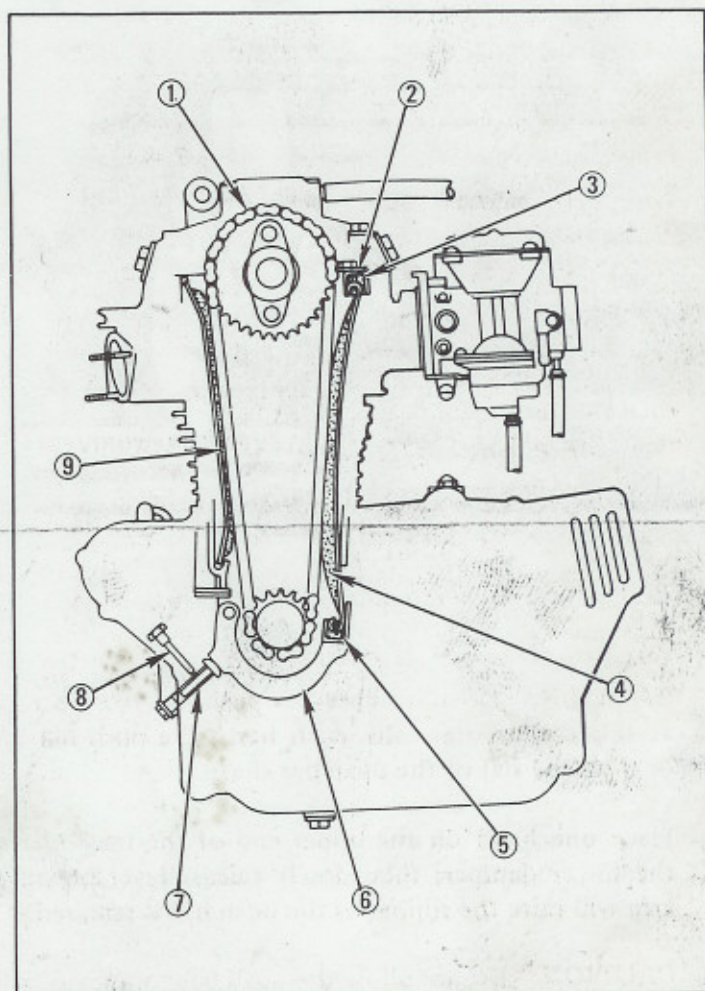

FIG. 1

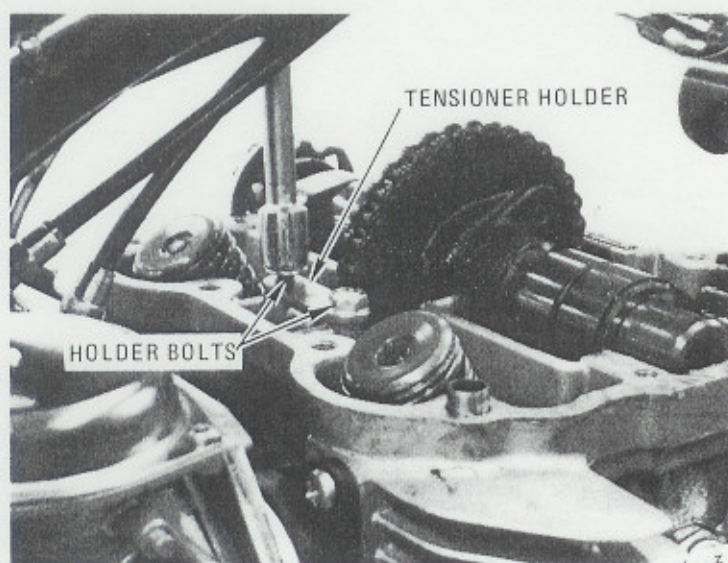

FIG. 2

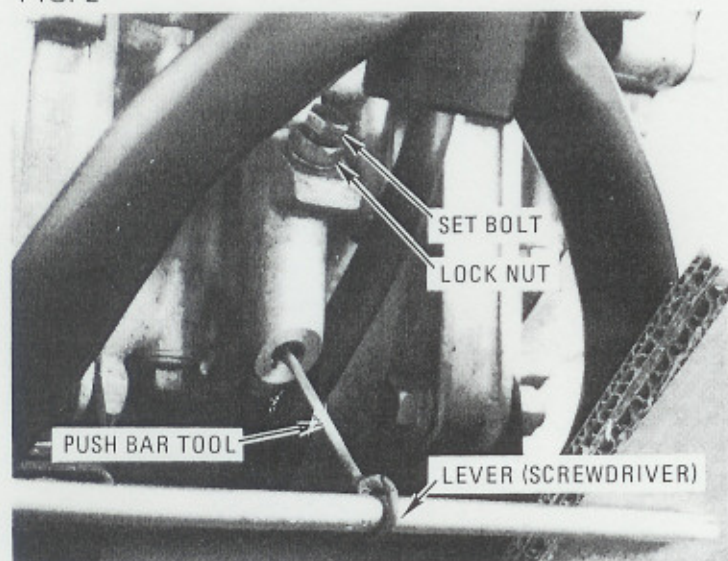

FIG. 3

1. Remove the cylinder head cover following the procedure described in the shop manual.
2. Remove the upper tensioner holder and damper (Fig. 2).
3. Remove the push bar cap. Screw the push bar tool into the push bar. Insert a lever (such as a large screwdriver) through the eye of the tool handle. Position the lever so the frame tube can be used as a fulcrum (Fig. 3). Pad the frame with cardboard, wood, or a shop rag to prevent scratching.

4. Loosen the lock nut and push bar set bolt while using the lever to prevent push bar movement.

CAUTION: Do not allow the push bar tool to rotate while the set bolt is loosened, as this could rotate the push bar. The push bar must be aligned so the set bolt can bear on the flat of the push bar shaft.

Place one hand on the upper end of the tensioner slipper to keep it firmly seated in the lower damper, then slowly release lever pressure on the push bar. The tensioner arm will raise the slipper as the push bar is released.

CAUTION: Do not allow the push bar to release suddenly, and do not release pressure on the tensioner slipper until it is fully raised, as this could cause the lower damper to pop out of the tensioner arm.

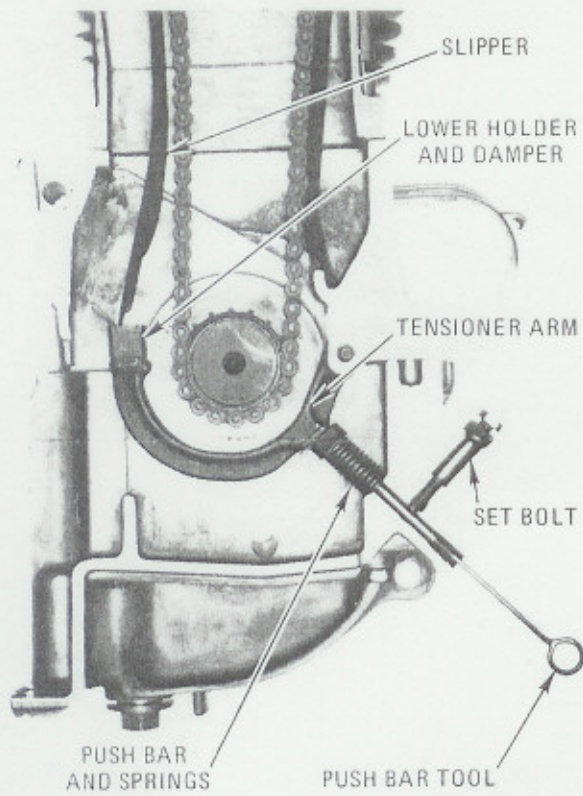

FIG. 4. Position of tensioner components after the upper tensioner holder has been removed. The push bar is shown in its normal operating position.

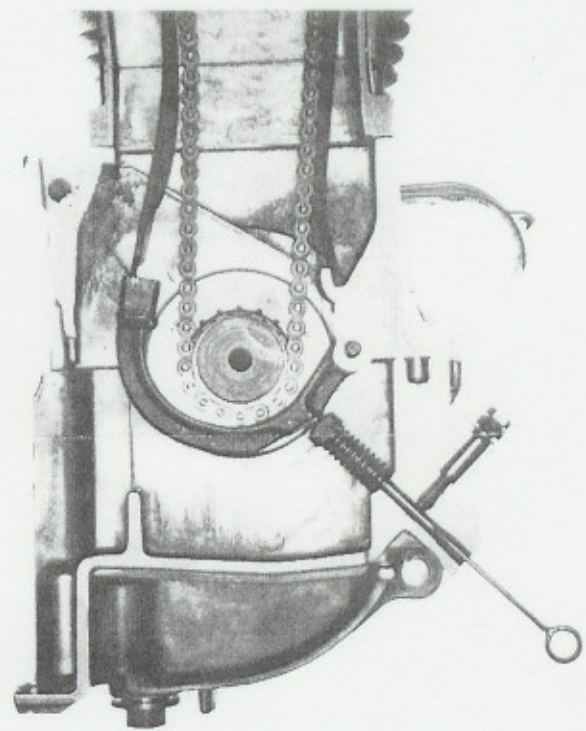
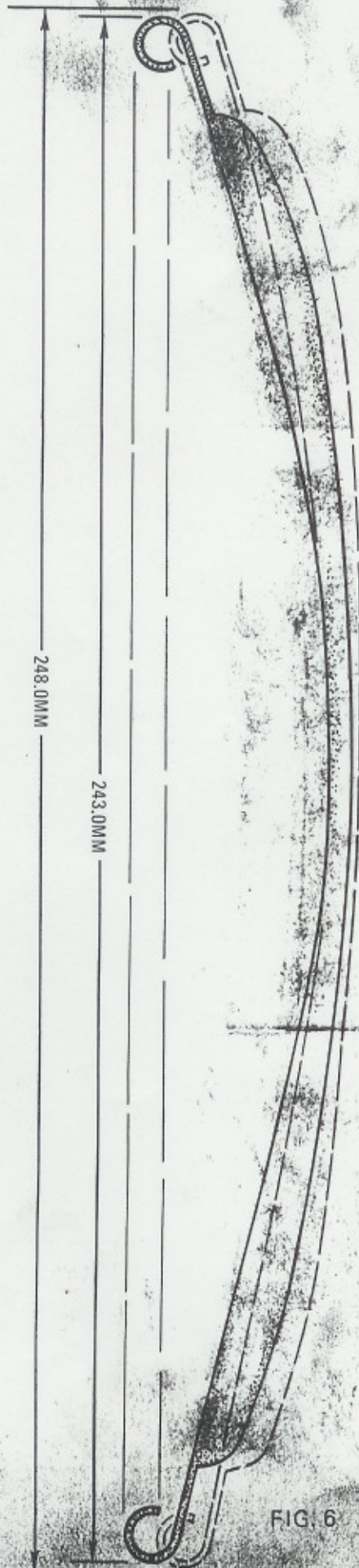

FIG. 5. Position of tensioner components with upper tensioner holder removed and push bar released. Releasing the push bar causes the tensioner arm to raise the slipper.

5. Remove and inspect the tensioner slipper.

CAUTION: Extensive slipper wear may cause engine oil to become contaminated with foreign particles. If the slipper shows extensive wear, clean the oil filter screen and oil filter rotor.



6. Check the replacement slipper against this illustration before installation. Length and contour must be within the limits shown.

If the slipper does not conform to the illustration, carefully bend it to bring length and contour within the limits shown. Be especially careful to maintain a smooth and symmetrical contour without sharp bends.

Also inspect the tensioner holder for signs of wear caused by the cam chain rubbing against the upper edge of the holder.

If inspection shows that the cam chain has been rubbing against the holder, replace the holder, cam chain, push bar, and push bar springs in addition to the tensioner slipper.

NOTE: Do not break the cam chain to speed its replacement. The use of master links is not permitted. If the cam chain requires replacement, you must dismantle the engine.

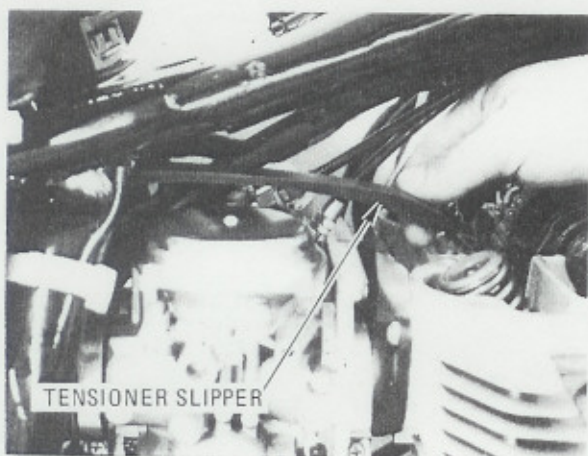

FIG. 7

7. Install the tensioner slipper, starting insertion from the position shown in Fig. 7.

As the slipper is inserted, maintain contact between the back of the slipper and the cylinder head casting (Fig. 8). This will keep the lower end of the slipper in contact with the cam chain, positioning the slipper to slide directly into the lower damper (Fig. 9).

CAUTION: Do not flex the slipper excessively during insertion, and do not use force. If the slipper becomes bent, it will not apply the correct tension. If the slipper does become bent during insertion, remove and reform as shown in Fig. 6.

NOTE: If the slipper catches on the engine castings while it is being inserted, rock the slipper slightly to free it, and continue insertion until the slipper enters the lower damper.

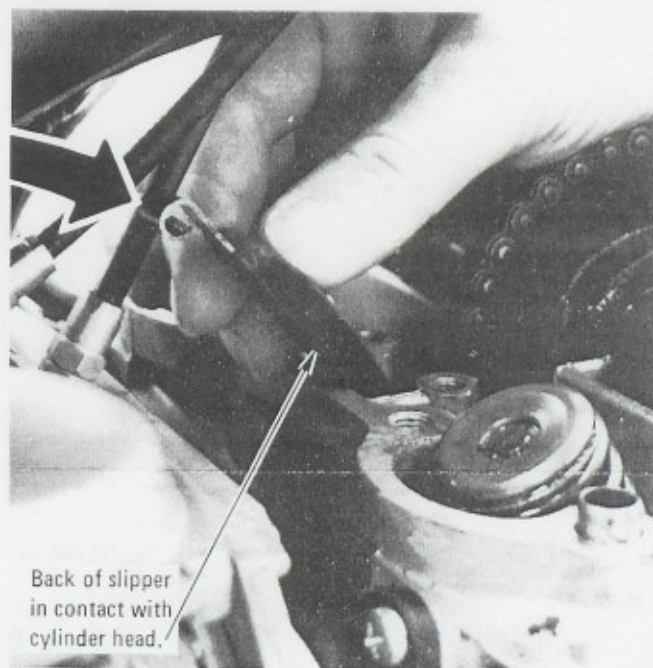

FIG. 8

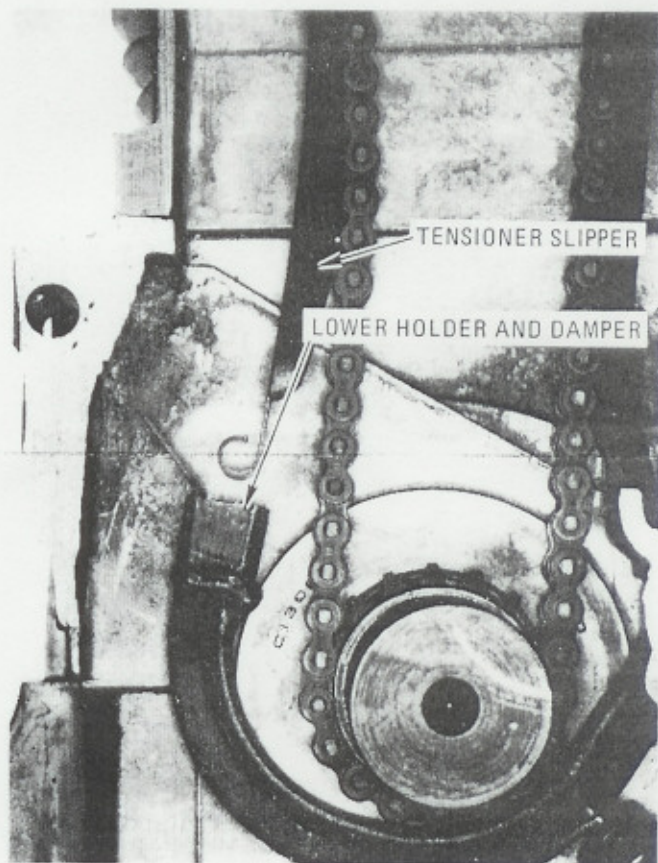

FIG. 9

8. Measure the distance between the cylinder head and the top of the installed slipper. If the slipper is correctly seated in the lower damper, this distance will be 8 - 15mm.

CORRECT



FIG. 10



INCORRECT



FIG. 12



INCORRECT

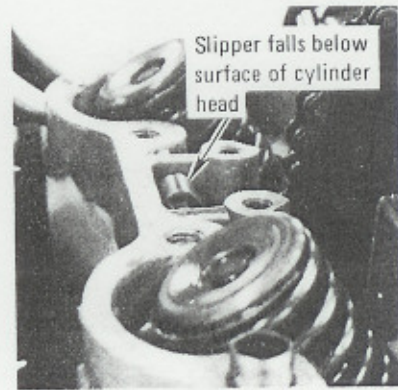

FIG. 14

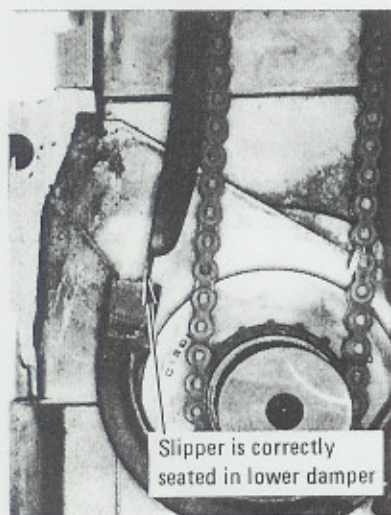

FIG. 11

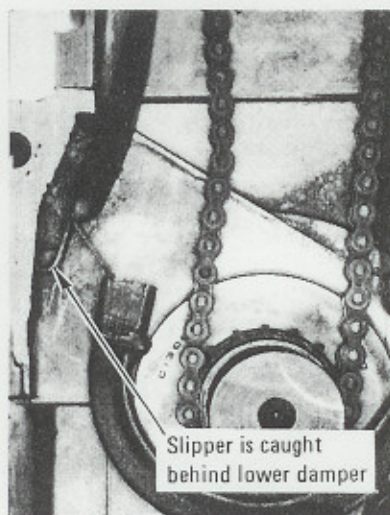

FIG. 13

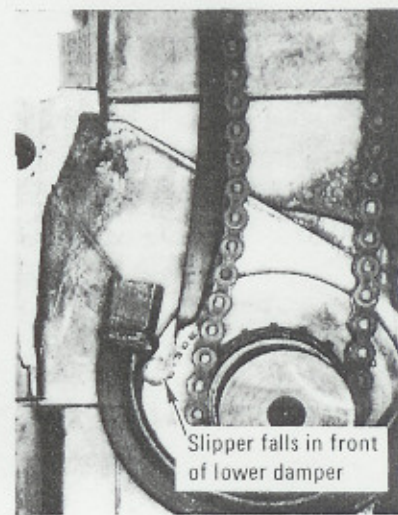

FIG. 15

If the correct measurement is not obtained the first time, check slipper contour, reinstall, and measure again. If the correct measurement is not obtained after repeated trials, dismantle the engine and correct the cause of the problem.

CAUTION: If the lower damper is found to be missing from the tensioner arm, it will have fallen into the crankcase and must be retrieved. A loose part dropped into the crankcase can cause engine damage.

9. Using the lever and push bar tool, fully retract the push bar. As you operate the lever with one hand, use the other hand to apply light downward pressure on the tensioner slipper to keep it seated in the lower damper.

When the push bar and tensioner slipper are fully lowered, remove your hand from the slipper, and tighten the push bar set bolt (Fig. 16).

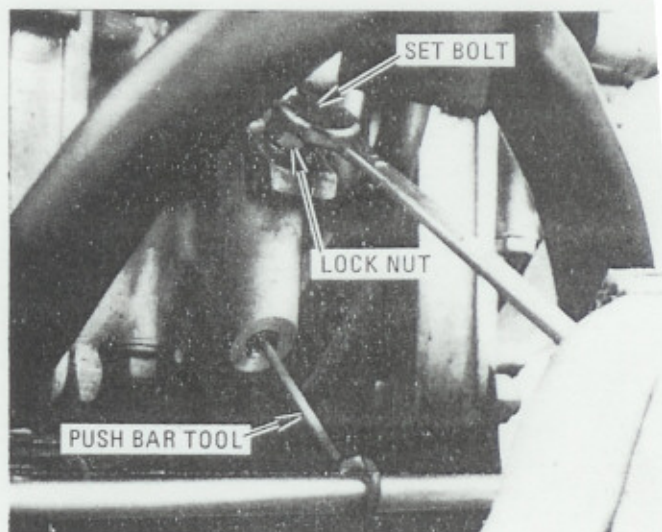

FIG. 16

10. Check tensioner slipper height (Fig. 17). The upper edge of the slipper should be below the upper surface of the cylinder head. If the slipper is not in this position, remove and reinstall.
11. Install the cam chain tensioner damper and holder (Fig. 18). Be certain the tensioner slipper is properly seated in the damper.

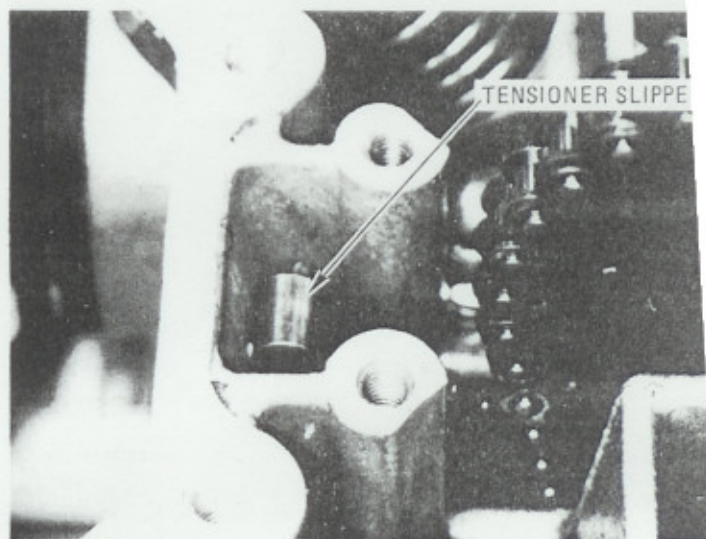

FIG. 17

12. Remove the push bar tool, and loosen the push bar set bolt. The push bar will automatically apply the correct cam chain tension. Retighten the set bolt to 80 - 120 kg-cm (69 - 104 lbs. in.). Tighten the lock nut securely.

CAUTION: Overtightening can damage the set bolt threads in the crankcase.

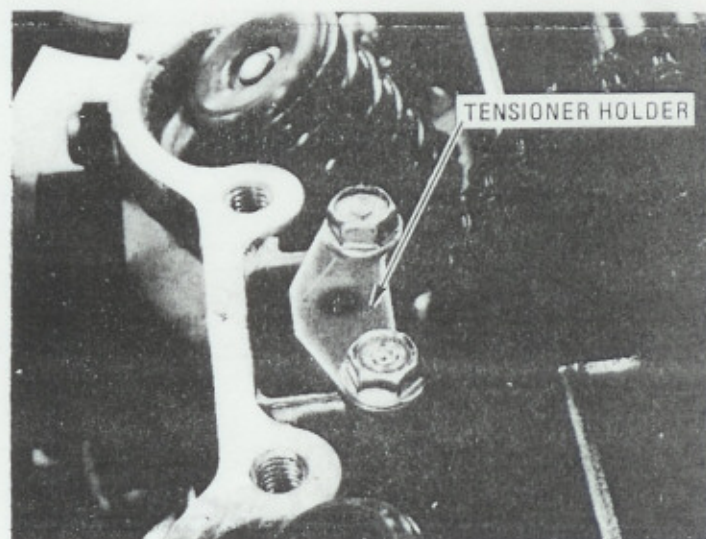

FIG. 18

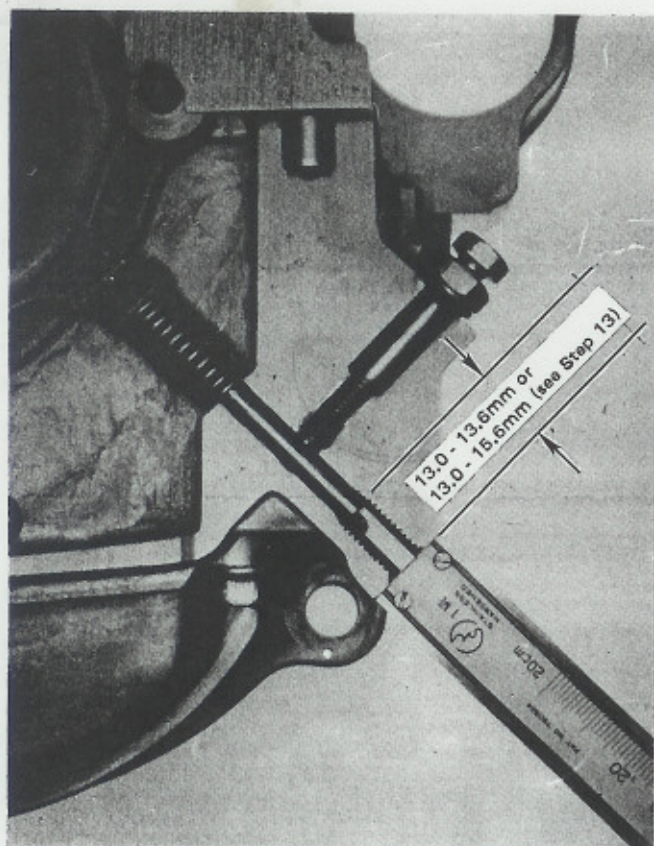

FIG. 19

13. Measure the distance between the bottom of the push bar and the mouth of the access hole (Fig. 19).

Fig. 19 dimension is 13.0 - 15.6mm for engines within the following serial number range:

MODEL	ENGINE SERIAL NUMBER
CB-360 & CB-360G	1000001 through 1085810
CL-360	1000001 through 1013033
CB-360T	2000001 through 2002566
CL-360 K1	2000001 through 2000079

Fig. 19 dimension is 13.0 - 13.6mm for all engines after the above serial number range.

If the correct measurement is obtained, install the push bar cap and proceed to Step 14.

If the correct measurement is not obtained, this indicates that the cam chain is worn, the lower damper is missing, or the tensioner slipper has been incorrectly installed. Repair or reinstall as necessary to obtain the correct measurement.

14. Reassemble following the procedure described in the shop manual. Observe the warning and cautions shown below (Fig. 20).

Check and adjust valve tappet clearances, ignition point gap, and ignition timing.

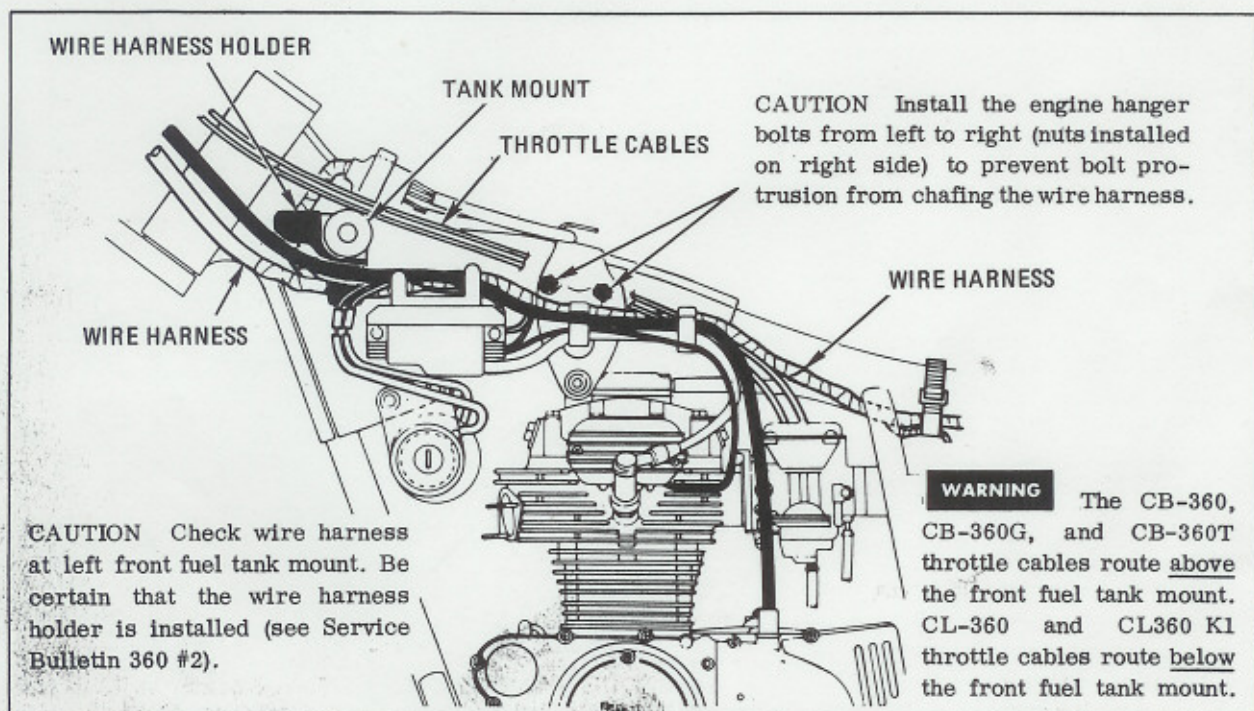

FIG. 20
8 OF 8