

W800

Motorcycle

OWNER'S MANUAL

 Read this manual carefully. It contains safety information.

Kawasaki

Quick Reference Guide

This Quick Reference Guide will assist you in finding the information you're looking for.

GENERAL INFORMATION

HOW TO RIDE THE MOTORCYCLE

SAFE OPERATION

MAINTENANCE AND ADJUSTMENT

STORAGE

A Table of Contents is included after the Foreword.

Whenever you see the symbols shown below, heed their instructions! Always follow safe operating and maintenance practices.

 **DANGER**

DANGER indicates a hazardous situation which, if not avoided, will result in death or serious injury.

 **WARNING**

WARNING indicates a hazardous situation which, if not avoided, could result in death or serious injury.

NOTICE

NOTICE is used to address practices not related to personal injury.

NOTE

- *NOTE* indicates information that may help or guide you in the operation or service of the vehicle.

NOTICE

**THIS PRODUCT HAS BEEN
MANUFACTURED FOR USE IN A
REASONABLE AND PRUDENT
MANNER BY A QUALIFIED OP-
ERATOR AND AS A VEHICLE
ONLY.**

TAMPERING WITH NOISE CONTROL SYSTEM PROHIBITED

Owners are warned that the law may prohibit:

- (a) The removal or rendering inoperative by any person other than for purposes of maintenance, repair or replacement, of any device or element of design incorporated into any new vehicle for the purpose of noise control prior to its sale or delivery to the ultimate purchaser or while it is in use; and
- (b) The use of the vehicle after such device or element of design has been removed or rendered inoperative by any person.

FOREWORD

Congratulations on your purchase of a new Kawasaki motorcycle. Your new motorcycle is the product of Kawasaki's advanced engineering, exhaustive testing, and continuous striving for superior reliability, safety and performance.

Please read this Owner's Manual carefully before riding so that you will be thoroughly familiar with the proper operation of your motorcycle's controls, its features, capabilities, and limitations. This manual offers many safe riding tips, but its purpose is not to provide instruction in all the techniques and skills required to ride a motorcycle safely. Kawasaki strongly recommends that all operators of this vehicle enroll in a motorcycle rider training program to attain awareness of the mental and physical requirements necessary for safe motorcycle operation.

To ensure a long, trouble-free life for your motorcycle, give it the proper care and maintenance described in this manual. For those who would like more detailed information on their Kawasaki Motorcycle, a Service Manual is available for purchase from any authorized Kawasaki motorcycle dealer. The Service Manual contains detailed disassembly and maintenance information. Those who plan to do their own work should, of course, be competent mechanics and possess the special tools described in the Service Manual.

Keep this Owner's Manual aboard your motorcycle at all times so that you can refer to it whenever you need information.

This manual should be considered a permanent part of the motorcycle and should remain with the motorcycle when it is sold.

All rights reserved. No part of this publication may be reproduced without our prior written permission.

This publication includes the latest information available at the time of printing. However, there may be minor differences between the actual product and illustrations and text in this manual.

All products are subject to change without prior notice or obligation.

KAWASAKI HEAVY INDUSTRIES, LTD.
Motorcycle & Engine Company

© 2014 Kawasaki Heavy Industries, Ltd.

Jun. 16, 2014. (1)

TABLE OF CONTENTS

SPECIFICATIONS	10	Fuel	33
LOCATION OF PARTS	14	Fuel Requirement:	33
LOADING INFORMATION	17	Filling the Tank:.....	35
GENERAL INFORMATION	20	Stands	37
Meter Instruments	20	Seat.....	38
Speedometer and Tachometer	21	Helmet Hook/Holding Cable.....	40
LCD (Clock, Odometer, Trip		Tool Kit	41
Meter).....	22	Document Compartment.....	42
Warning/Indicator Lights	25	Tying Hooks	42
Key.....	27	Rear View Mirror	43
Ignition Switch/Steering Lock	27	BREAK-IN	44
Right Handlebar Switches.....	29	HOW TO RIDE THE MOTORCYCLE .	46
Engine Stop Switch:	29	Starting the Engine	46
Starter Button:	30	Jump Starting.....	48
Left Handlebar Switches	30	Moving Off.....	51
Dimmer Switch:	30	Shifting Gears	52
Turn Signal Switch:.....	31	Braking	53
Horn Button:	31	Stopping the Engine.....	55
Brake/Clutch Lever Adjuster	31	Stopping the Motorcycle in an	
Fuel Tank Cap.....	32	Emergency	55

Parking	56	Clutch	95
Catalytic Converter.....	58	Drive Chain	97
SAFE OPERATION	60	Brakes	105
Safe Riding Technique	60	Brake Light Switch	110
Daily Checks	63	Front Fork.....	112
Additional Considerations for High Speed Operation	66	Rear Shock Absorber.....	113
MAINTENANCE AND ADJUSTMENT	68	Wheels	116
Periodic Maintenance Chart.....	68	Spoke and Rim:	119
Engine Oil	78	Battery.....	120
Spark Plugs.....	84	Headlight Beam.....	127
Kawasaki Clean Air System	85	Fuses	128
Valve Clearance	86	General Lubrication.....	131
Air Cleaner	86	Cleaning Your Motorcycle	132
Throttle Control System	91	STORAGE	138
Engine Vacuum Synchronization	93	ENVIRONMENTAL PROTECTION	141
Idle Speed	94	OWNER SATISFACTION	142
		LOCATION OF LABELS	144

10 SPECIFICATIONS

SPECIFICATIONS

PERFORMANCE

Maximum Horsepower	35 kW (48 PS) @6 500 r/min (rpm)
Maximum Torque	60 N·m (6.1 kgf·m, 44.3 ft·lb) @2 500 r/min (rpm)
Minimum Turning Radius	2.7 m (8.9 ft)

DIMENSIONS

Overall Length	2 190 mm (86.22 in.)
Overall Width	790 mm (31.10 in.)
Overall Height	1 075 mm (42.32 in.)
Wheelbase	1 465 mm (57.68 in.)
Road Clearance	125 mm (4.92 in.)
Curb Mass	217 kg (478 lb)

ENGINE

Type	SOHC, 2-cylinder, 4-stroke, air-cooled
Displacement	773 cm ³ (47.2 cu in.)
Bore × Stroke	77.0 × 83.0 mm (3.03 × 3.27 in.)

Compression Ratio	8.4 : 1
Starting System	Electric starter
Cylinder Numbering Method	Left to right, 1-2
Firing Order	1-2
Fuel System	FI (Fuel Injection)
Ignition System	Battery and coil (transistorized ignition)
Ignition Timing	0° BTDC @1 200 r/min (rpm)
Spark Plug	NGK CR8E
Lubrication System	Forced lubrication (wet sump)
Engine Oil	Type : API SG, SH, SJ, SL or SM with JASO MA, MA1 or MA2
	Viscosity: SAE 10W-40
	Capacity : 3.2 L (3.4 US qt)

TRANSMISSION

Transmission Type	5-speed, constant mesh, return shift
Clutch Type	Wet, multi disc
Driving System	Chain drive

12 SPECIFICATIONS

Primary Reduction Ratio		2.095 (88/42)
Final Reduction Ratio		2.467 (37/15)
Overall Drive Ratio		4.403 (Top gear)
Gear Ratio	1st	2.353 (40/17)
	2nd	1.591 (35/22)
	3rd	1.240 (31/25)
	4th	1.000 (28/28)
	5th	0.852 (23/27)

FRAME

Caster		27°
Trail		108 mm (4.3 in.)
Tire Size:	Front	100/90-19M/C 57H
	Rear	130/80-18M/C 66H
Rim Size:	Front	J19 × 2.15
	Rear	J18M/C × MT2.75
Fuel Tank Capacity		14 L (3.7 US gal)

ELECTRICAL EQUIPMENT

Battery	12 V 10 Ah (10 HR)
Headlight	High beam 12 V 60 W Low beam 12 V 55 W
Brake/Tail Light	12 V 21/5 W

Specifications are subject to change without notice.

LOCATION OF PARTS

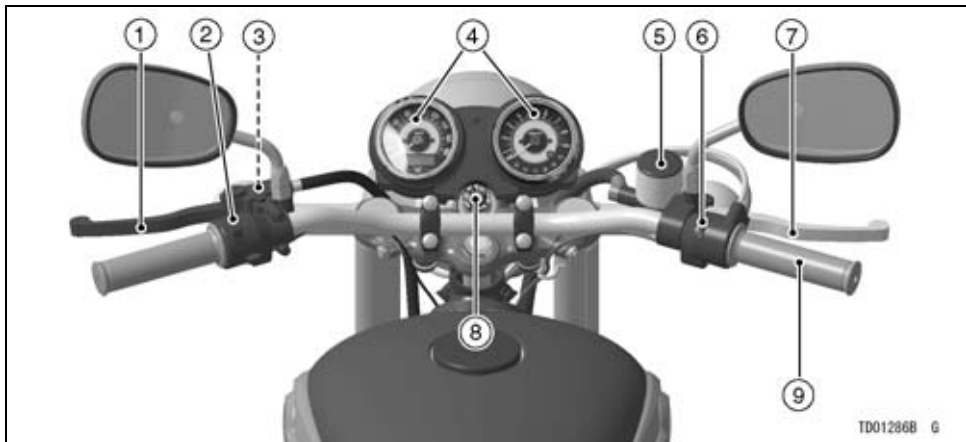

1. Clutch Lever
2. Left Handlebar Switches
3. Starter Lockout Switch
4. Meter Instruments
5. Brake Fluid Reservoir (Front)

6. Right Handlebar Switches
7. Front Brake Lever
8. Ignition Switch/Steering Lock
9. Throttle Grip

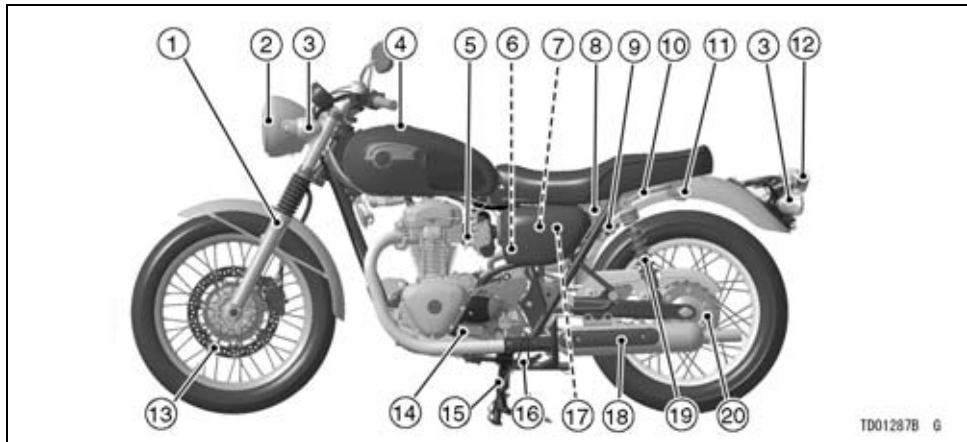

TD01287B G

- | | |
|----------------------------|-------------------------|
| 1. Front Fork | 11. Tying Hook |
| 2. Headlight | 12. Tail/Brake Light |
| 3. Turn Signal Lights | 13. Brake Disc |
| 4. Fuel Tank Cap | 14. Shift Pedal |
| 5. Idle Adjusting Screw | 15. Center Stand |
| 6. Air Cleaner Element | 16. Side Stand |
| 7. Junction Box (Fuse Box) | 17. Battery |
| 8. Seat Lock | 18. Muffler |
| 9. Helmet Hook | 19. Rear Shock Absorber |
| 10. Grab Rail | 20. Drive Chain |

16 LOCATION OF PARTS

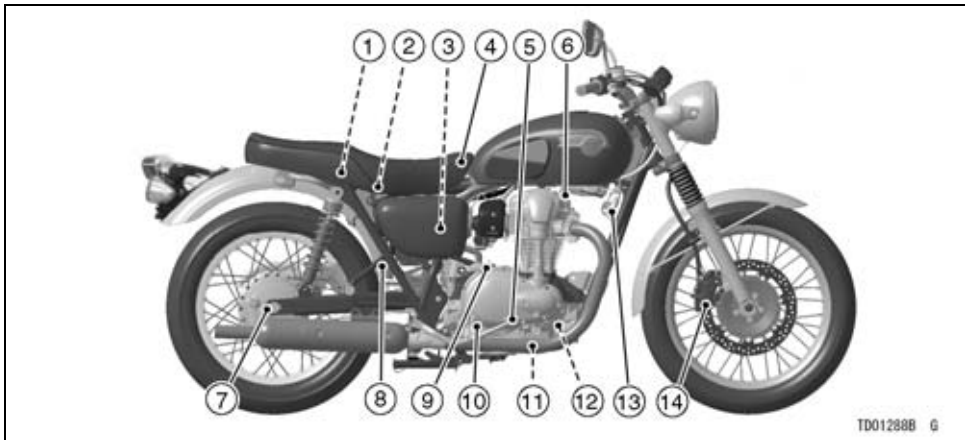

TD01288B G

1. Helmet Holding Cable
2. Tool Kit
3. Air Cleaner Element
4. Seat
5. Rear Brake Pedal
6. Spark Plugs
7. Brake Lining Wear Indicator

8. Rear Brake Light Switch
9. Oil Filler Cap
10. Oil Level Inspection Window
11. Oil Drain Bolt
12. Oil Filter
13. Horn
14. Brake Caliper

LOADING INFORMATION

 **WARNING**

Incorrect loading, improper installation or use of accessories, or modification of your motorcycle may result in an unsafe riding condition. Before you ride the motorcycle, make sure it is not overloaded and that you have followed these instructions.

With the exception of genuine Kawasaki Parts and Accessories, Kawasaki has no control over the design or application of accessories. In some cases, improper installation or use of accessories, or motorcycle modification, will void the motorcycle warranty, can negatively affect performance, and can even be illegal.

In selecting and using accessories, and in loading the motorcycle, you are personally responsible for your own safety and the safety of other persons involved.

NOTE

- *Kawasaki Parts and Accessories have been specially designed for use on Kawasaki motorcycles. We strongly recommend that all parts and accessories you add to your motorcycle be genuine Kawasaki components.*

Because a motorcycle is sensitive to changes in weight and aerodynamic forces, you must take extreme care in carrying cargo, passengers and/or in the fitting of additional accessories.

18 LOADING INFORMATION

The following general guidelines have been prepared to assist you in making your determinations.

1. Any passenger should be thoroughly familiar with motorcycle operation. The passenger can affect control of the motorcycle by improper positioning during cornering and sudden movements. It is important that the passenger sit still while the motorcycle is in motion and not interfere with the operation of the motorcycle. Do not carry animals on your motorcycle.
2. You should instruct any passenger before riding to keep his feet on the passenger footpegs and hold on to the operator or grab rail. Do not carry a passenger unless he or she is tall enough to reach the footpegs and footpegs are provided.
3. All baggage should be carried as low as possible to reduce the effect on the motorcycle center of gravity. Baggage weight should also be distributed equally on both sides of the motorcycle. Avoid carrying baggage that extends beyond the rear of the motorcycle.
4. Baggage should be securely attached. Make sure that the baggage will not move around while you are riding. Recheck baggage security as often as possible (not while the motorcycle is in motion) and adjust as necessary.
5. Do not carry heavy or bulky items on a luggage rack. They are designed for light items, and overloading can affect handling due to changes in weight distribution and aerodynamic forces.
6. Do not install accessories or carry baggage that impairs the performance of the motorcycle. Make sure that you have not adversely

affected any lighting components, road clearance, banking capability (i.e., lean angle), control operation, wheel travel, front fork movement, or any other aspect of the motorcycle's operation.

7. Weight attached to the handlebar or front fork will increase the mass of the steering assembly and can result in an unsafe riding condition.
8. Fairings, windshields, backrests, and other large items have the capability of adversely affecting stability and handling of the motorcycle, not only because of their weight, but also due to the aerodynamic forces acting on these surfaces while the motorcycle is in operation. Poorly designed or installed items can result in an unsafe riding condition.
9. This motorcycle was not intended to be equipped with a sidecar or to

be used to tow any trailer or other vehicle. Kawasaki does not manufacture sidecars or trailers for motorcycles and cannot predict the effects of such accessories on handling or stability, but can only warn that the effects can be adverse and that Kawasaki cannot assume responsibility for the results of such unintended use of the motorcycle. Furthermore, any adverse effects on motorcycle components caused by the use of such accessories will not be remedied under warranty.

Maximum Load

Weight of rider, passenger, baggage, and accessories must not exceed 183 kg (403 lb).

Meter Instruments

- A. Speedometer
- B. MODE Button
- C. RESET Button
- D. Tachometer
- E. Red Zone
- F. FI Warning Indicator Light
- G. Oil Pressure Warning Indicator Light
- H. Right Turn Signal Indicator Light
- I. Fuel Level Warning Indicator Light
- J. Neutral Indicator Light
- K. High Beam Indicator Light
- L. Left Turn Signal Indicator Light
- M. LCD (Odometer/Trip Meter/Clock)

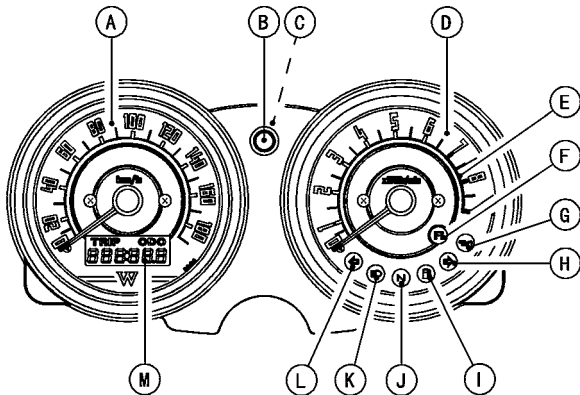

Speedometer and Tachometer

The speedometer shows the speed of the vehicle. The needle of the speedometer and tachometer momentarily sweeps from the minimum to maximum and back to minimum when the ignition switch is turned to "ON". This checks the operation of the meter needles. So if they do not operate correctly, have the function checked by an authorized Kawasaki dealer.

The tachometer shows the engine speed in the revolutions per minute (r/min, rpm). On the right side of the

tachometer face is a portion called the "red zone." Engine r/min (rpm) in the red zone is above maximum recommended engine speed and is also above the range for good performance.

NOTICE

Engine r/min (rpm) should not be allowed to enter the red zone; operation in the red zone will overstress the engine and may cause serious engine damage.

22 GENERAL INFORMATION

LCD (Clock, Odometer, Trip Meter)

The LCD (Liquid Crystal Display) located in the speedometer face is used to display the Clock, Odometer and Trip Meter. Pushing the MODE button shifts the display through the following three modes: CLOCK, ODO, and TRIP. When the ignition switch is turned to “ON”, all the LCD segments are displayed for three seconds, then the clock or meters operate normally depending on the mode selected.

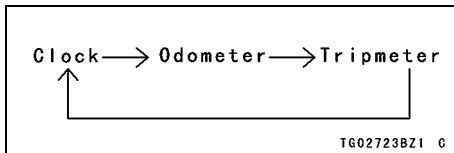

⚠ WARNING

For Safety, do not operate the meter buttons while riding the motorcycle.

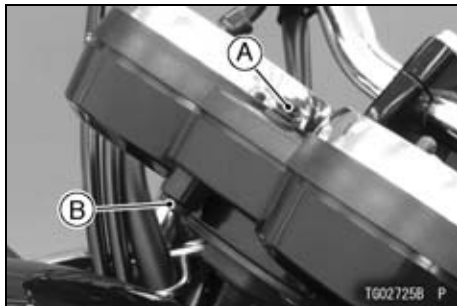

A. MODE Button
B. RESET Button

Clock -

To adjust the hours and minutes:

- Turn the ignition switch to “ON”.
- Push the MODE button to display the clock.
- Push the RESET button for more than two seconds. Both the hour and minute displays start blinking.

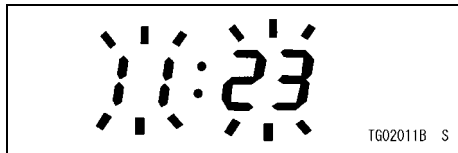

- Push the RESET button. The hour display only blinks. Push the MODE button to advance the hours.

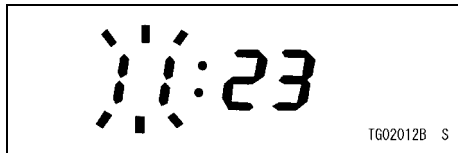

- Push the RESET button. The hour display stops blinking and the minute display starts blinking. Push the MODE button to advance the minutes.

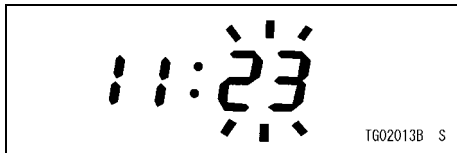

- Push the RESET button. Both the hour and minute displays start blinking again.
- Push the MODE button. The displays stop blinking and the clock starts working.

NOTE

- *Pushing the MODE button momentarily advances the hour or minute step by step. Pushing and holding the button advance the hour or minute continuously.*
- *The clock works normally from the back-up power while the ignition switch is turned off.*

24 GENERAL INFORMATION

- *When the battery is disconnected, the clock resets to 1:00 and starts working again when the battery is connected.*

Odometer -

The odometer shows the total distance in kilometers the vehicle has been ridden. This meter cannot be reset.

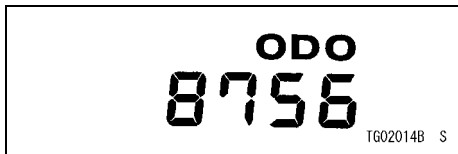

NOTE

- *The data is maintained even if the battery is disconnected.*

- *When the figures come to 999999, they are stopped and locked.*

Trip Meter -

The trip meters show the distance in kilometers traveled since it was last reset to zero.

To reset the trip meter:

- Push the MODE button to display the trip meter.
- Push the MODE button and hold it in.
- After two seconds, the figure display turns to 0.0, and then starts counting when the vehicle is operated. The meter counts until it is reset.

NOTE

- *The data is maintained even if the battery is disconnected.*
- *When the trip meter reaches 9999.9 while running, the meter reset to 0.0 and continues counting.*

Warning/Indicator Lights

 : The oil pressure warning indicator light goes on whenever the oil pressure is dangerously low or the ignition switch is in the ON position with the engine not running, and goes off when the engine oil pressure is high enough. Refer to the Maintenance and Adjustment chapter for more detailed engine oil information.

 : When the headlight is on high beam, the high beam indicator light is lit.

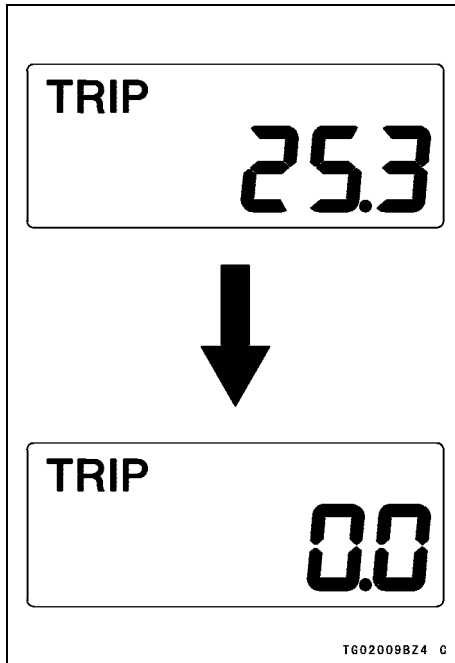

26 GENERAL INFORMATION

↔ : When the turn signal switch is turned to left or right, the turn signal indicator light blinks on and off.

N : When the transmission is in neutral, the neutral indicator light goes on.

FI: The fuel injection (FI) warning indicator light goes on when the ignition switch is turned to “ON” and goes off soon after ensuring that its circuit functions properly.

The warning indicator light also goes on whenever the troubles occur in digital fuel injection system (DFI). If the warning indicator light blinks on, have the DFI system checked by an authorized Kawasaki dealer.

 : The fuel level warning indicator light goes on when the ignition switch is

turned to “ON” and goes off soon after ensuring that its circuit functions properly.

The warning indicator light also goes on and “FUEL” blinks in the LCD when approximately 3.1 L (0.8 US gal) of fuel remains.



Refuel at the earliest opportunity when the fuel level warning indicator light goes on and “FUEL” blinks.

When vehicle stands with side stand, fuel level warning indicator light cannot show the amount of fuel in the fuel tank exactly. Stand upright the vehicle to check the fuel level.

Key

This motorcycle has a combination key, which is used for the ignition switch/steering lock, seat lock, helmet hook and fuel tank cap.

Blank keys are available at your Kawasaki dealers. Ask your dealer to make any additional spare keys you may need, using your original key as a master.

Ignition Switch/Steering Lock

This is a four-position, key-operated switch. The key can be removed from the switch when it is in the OFF, LOCK or P (Park) position.

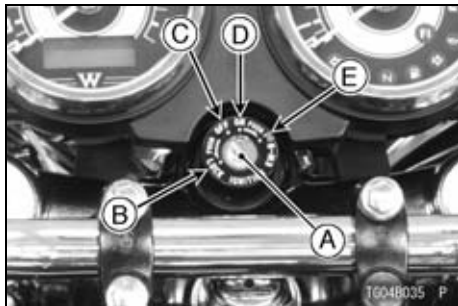

- A. Ignition Switch/Steering Lock
- B. LOCK position
- C. OFF position
- D. ON position
- E. P (Park) position

28 GENERAL INFORMATION

OFF	Engine off. Electrical circuits off.
ON	Engine on. All electrical equipment can be used.
LOCK	Steering locked. Engine off. Electrical circuits off.
P (Park)	Steering locked. Engine off. Tail and city lights on. Other electrical circuits cut out.

NOTE

- *The taillight is on whenever the ignition switch is in the ON position. One headlight goes on when the starter button is released after starting the engine. To avoid battery discharge, always start the engine immediately after turning the ignition switch to "ON".*

- *If you leave the P (Park) position on for a long time (one hour), the battery may become totally discharged.*

To operate the ignition Switch:

OFF ← ↔ ON → 2a → P (Park)



1. Turn the handlebar fully to the left.

2. a. For parking push down the key in the ON position and turn it to P(Park).

LOCK

b. For locking push down the key in the OFF position and turn it to LOCK.

T804001B22 C

Right Handlebar Switches

Engine Stop Switch:

In addition to the ignition switch, the engine stop switch must be in the  position for the motorcycle to operate.

The engine stop switch is for emergency use. If required, move the switch to the  position.

NOTE

- Although the engine stop switch stops the engine, it does not turn off all the electrical circuits. Ordinarily, the ignition switch should be used to stop the engine.

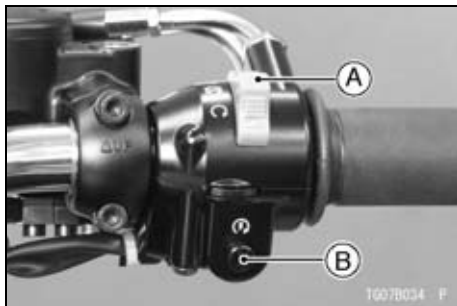

A. Engine Stop Switch

B. Starter Button

30 GENERAL INFORMATION

Starter Button:

The starter button operates the electric starter when the transmission is in neutral.

Refer to the Starting the Engine section of the "How to Ride the Motorcycle" chapter for starting instructions.

Left Handlebar Switches

Dimmer Switch:

High or low beam can be selected with the dimmer switch. When the headlight is on high beam (), the high beam indicator light is lit.

High beam.....()

Low beam.....()

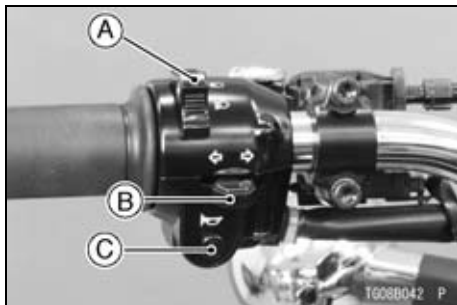

A. Dimmer Switch



B. Turn Signal Switch

C. Horn Button

NOTE

- *Do not allow anything to cover the headlight lens when the headlight is on. If covered, heat can build up in the headlight lens causing lens discoloration or melting, as well as damage to the item covering the lens.*

Turn Signal Switch:

When the turn signal switch is turned to the left () or right (), the corresponding turn signal blinks on and off.

To stop blinking, push the switch in.

Horn Button:

When the horn button is pushed, the horn sounds.

Brake/Clutch Lever Adjuster

There are adjusters on both the brake and clutch levers. The brake lever adjuster has 4 positions and the clutch lever adjuster has 5 positions so that the released lever position can be adjusted to suit the operator's hands.

Push the lever forward and turn the adjuster to align the number with the triangular mark on brake lever and the triangular mark on the clutch lever.

The distance from the grip to the released lever is minimum at Number 4 for the brake lever and Number 5 for the clutch lever, and maximum at Number 1 for both.

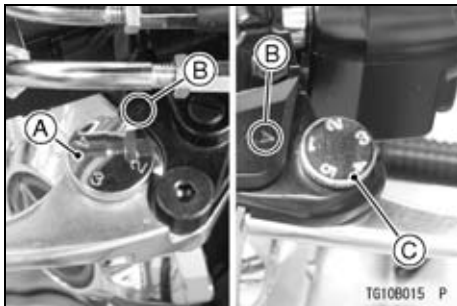

- A. Brake Lever Adjuster
- B. Mark
- C. Clutch Lever Adjuster

Fuel Tank Cap

To open the fuel tank cap, insert the ignition key into the fuel tank cap and turn the key clockwise while pushing down the fuel tank cap.

To close the cap, push it down into place with the key inserted. The key can be removed by turning it to the left to the original position.

NOTE

- *The fuel tank cap cannot be closed without the key inserted, and the key cannot be removed unless the cap is locked properly.*

NOTE

- *Do not push on the key to close the cap, or the cap cannot be locked.*

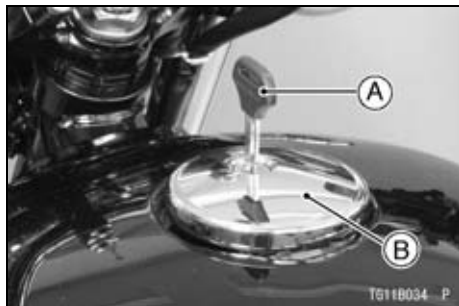

- A. Ignition Key**
B. Fuel Tank Cap

Fuel**Fuel Requirement:**

Your Kawasaki engine is designed to use only unleaded gasoline with a minimum octane rating shown below. Never use gasoline with an octane rating lower than the minimum specified by Kawasaki to prevent severe engine damage.

The octane rating of a gasoline is a measure of its resistance to detonation or “knocking”. The term commonly used to describe a gasoline’s octane rating is the Research Octane Number (RON).

NOTICE

Do not use leaded gasoline, as this will destroy the catalytic converter. (For further information, refer to the “Catalytic Converter” section in the “How to Ride the Motorcycle” chapter.)

NOTICE

If engine “knocking” or “pinging” occurs, use a different brand of gasoline of a higher octane rating. If this condition is allowed to continue, it can lead to severe engine damage. Gasoline quality is important. Fuels of low quality or not meeting standard industry specifications may result in unsatisfactory performance. Operating problems that result from the use of poor quality or no recommended fuel may not be covered under your warranty.

Fuel Type and Octane Rating

Use clean, fresh unleaded gasoline with an ethanol volume content not more than 10% and an octane rating

equal to or higher than that shown in the table.

Fuel Type	Unleaded Gasoline
Ethanol Content	E10 or less
Minimum Octane Rating	Research Octane Number (RON) 91

NOTICE

Do not use any fuel that contains more ethanol or other oxygenates than specified for E10 fuel* in this vehicle. Damage to the engine and fuel system, or engine starting and/or performance problems may result from the use of improper fuel.

*E10 means fuel containing up to 10% ethanol.

Filling the Tank:

Avoid filling the tank in the rain or where heavy dust is blowing so that the fuel does not get contaminated.

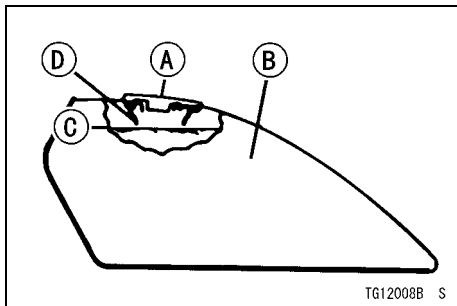

- A. Tank Cap
- B. Fuel Tank
- C. Top Level
- D. Filler Neck

TG12008B S

 **WARNING**

Gasoline is extremely flammable and can be explosive under certain conditions, creating the potential for serious burns. Turn the ignition switch to "OFF". Do not smoke. Make sure the area is well-ventilated and free from any source of flame or sparks; this includes any appliance with a pilot light. Never fill the tank completely to the top. If the tank is filled completely to the top, heat may cause the fuel to expand and overflow through the vents in the tank cap. After refueling, make sure the tank cap is closed securely. If gasoline is spilled on the fuel tank, wipe it off immediately.

NOTICE

Certain ingredients in gasoline may cause paint fading or damage. Be extra careful not to spill fuel during refueling.

Stands

The motorcycle is equipped with two stands: a center stand and a side stand.

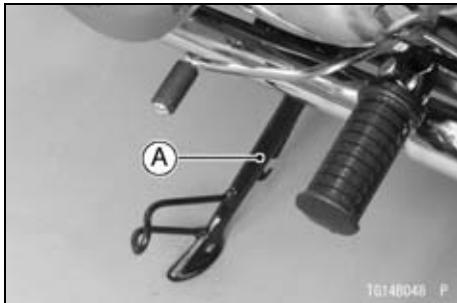

A. Side Stand

NOTE

- *When using the side stand, turn the handlebar to the left.*

Do not sit on the motorcycle while it is on its side stand or centre stand. Always kick the stand fully up before sitting on the motorcycle.

NOTE

- *The motorcycle is equipped with a side stand switch. This switch is designed so that the engine stops if the clutch is engaged with the transmission in gear when the side stand is down.*

38 GENERAL INFORMATION

To set the motorcycle up on the center stand, step down firmly on the stand, and then lift the motorcycle up and to the rear using the grab rail as a handhold. Don't pull up on the seat to lift as this will damage the seat.

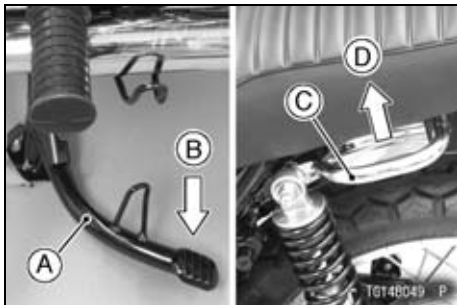

- A. Center Stand
- B. Step down
- C. Grab Rail
- D. Lift up

Seat

Seat Removal

- Remove the seat by inserting the ignition key into the seat lock and turning it clockwise.

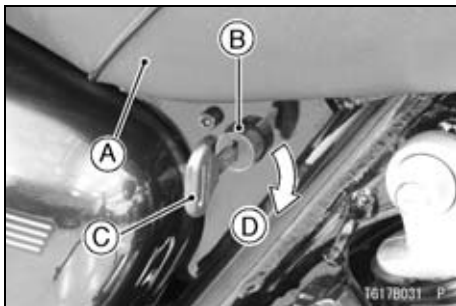

- A. Seat
- B. Seat Lock
- C. Ignition Key
- D. Turn Clockwise

Seat Installation

- Insert the tab on the front of the seat into the hole on the frame, and the projections on the middle of the seat into the hole in the frame.

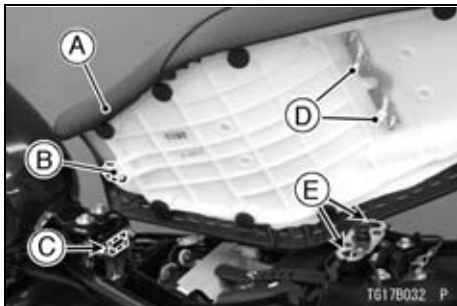

- A. Seat
- B. Tab
- C. Hole
- D. Projections
- E. Holes

- Push down the seat until the lock clicks.
- Pull up the front and rear end of the seat to make sure they are securely locked.

40 GENERAL INFORMATION

Helmet Hook/Holding Cable

Helmets can be secured to the motorcycle using the helmet hook located at the left side of the motorcycle or the helmet holding cable located under the seat.

Helmet Hook -

To unlock the helmet hook, insert the ignition key into the lock and turning it clockwise.

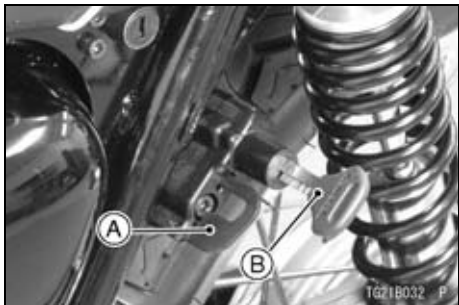

- A. Helmet Hook
- B. Ignition Key

Helmet Holding Cable -

Helmet can be secured to the motorcycle using the helmet holding cable. Securely hook the helmet ring with the helmet holding cable and install the seat.

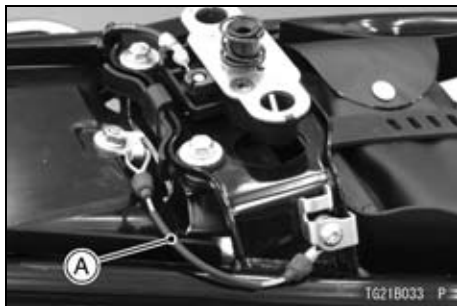

- A. Helmet Holding Cable

⚠ WARNING

Riding with helmets attached to the hooks could cause an accident by distracting the operator or interfering with normal vehicle operation. Do not ride the motorcycle with helmets attached to the hooks.

Tool Kit

The tool kit is located under the seat.

The kit contains tools that are helpful in making roadside repairs, adjustments, and some maintenance procedures explained in this manual. Keep the tool kit in the original place.

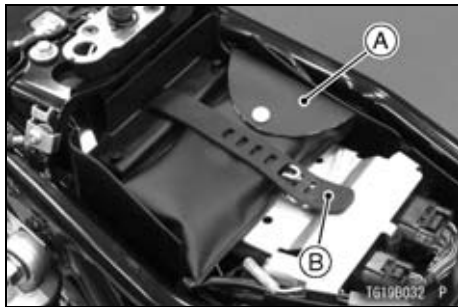

- A. Tool Kit
- B. Band

Document Compartment

The document compartment is provided at the rear under the seat. Use the compartment to keep the owner's manual and any papers or documents that should be kept with the motorcycle.

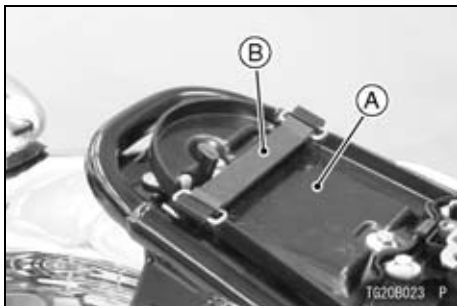

- A. Document Compartment
- B. Band

Tying Hooks

When tying up light loads to the seat, use the tying hooks located on the left and right sides under the seat.

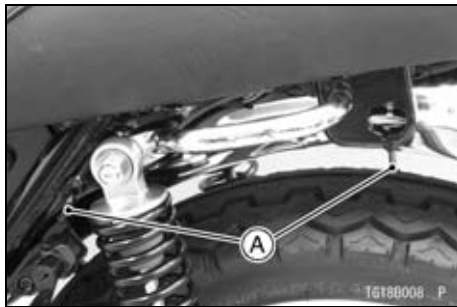

- A. Tying Hooks

Rear View Mirror

Rear View Mirror Adjustment

- Adjust the rear view mirror by slightly moving only the mirror portion of the assembly.
- If the rear visibility can not be assured by moving the mirror, slide the cover and loosen the upper hexagonal area and turn the stay by hand.

Tightening Torque

Lower Hexagonal Area:

30 N·m (3.1 kgf·m, 22 ft·lb)

Upper Hexagonal Area:

30 N·m (3.1 kgf·m, 22 ft·lb)

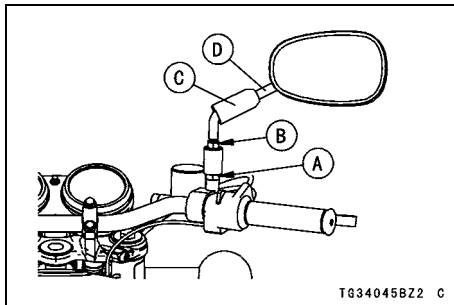

- A. Lower Hexagonal Area for Tightening
- B. Upper Hexagonal Area
- C. Cover
- D. Rear View Mirror

NOTE

- *If a torque wrench is not available, this item should be serviced by a Kawasaki dealer.*

BREAK-IN

The first 1 600 km (1 000 mi) that the motorcycle is ridden is designated as the break-in period. If the motorcycle is not used carefully during this period, you may very well end up with a "broken down" instead of a "broken in" motorcycle after a few thousand kilometers.

The following rules should be observed during the break-in period.

- The table shows maximum recommended engine speed during the break-in period.

Distance traveled	Maximum engine speed
0 ~ 800 km (0 ~ 500 mi)	4 000 r/min (rpm)
800 ~ 1 600 km (500 ~ 1 000 mi)	6 000 r/min (rpm)

NOTE

- *When operating on public roadways, keep maximum speed under traffic law limits.*
- Do not start moving or race the engine immediately after starting it, even if the engine is already warm. Run the engine for two or three minutes at idle speed to give the oil a chance to work up into all the engine parts.
- Do not race the engine while the transmission is in neutral.

 **WARNING**

New tires are slippery and may cause loss of control and injury. A break-in period of 160 km (100 miles) is necessary to establish normal tire traction. During break-in, avoid sudden and maximum braking and acceleration, and hard cornering.

In addition to the above, at 1 000 km (600 mi) it is extremely important that the owner have the initial maintenance service performed by an authorized Kawasaki dealer.

HOW TO RIDE THE MOTORCYCLE

Starting the Engine

- Check that the engine stop switch is in the  position.
- Turn the ignition switch to "ON".
- Make sure the transmission is in neutral.
- Without holding the throttle grip, push the starter button to start the engine.

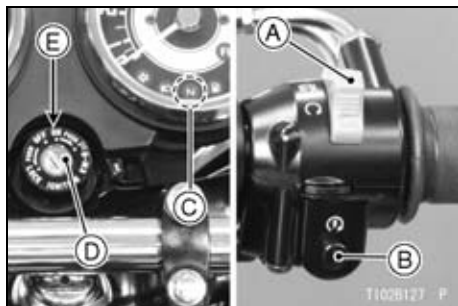

- A. Engine Stop Switch
- B. Starter Button
- C. Neutral Indicator Light
- D. Ignition Switch
- E. ON position

NOTE

- *The FI warning indicator light may stay on for a few seconds. However, as long as it goes off soon, there is no problem with the motorcycle riding.*
- *While the engine is cold, the fast idle system automatically raises the engine idling speed. At this time, the engine warning indicator light may go on if you operate the throttle grip unnecessarily.*
- *The motorcycle is equipped with a vehicle-down sensor, which causes the engine to stop automatically.*

NOTICE

Do not operate the starter continuously for more than 5 seconds or the starter will overheat and the battery power will drop temporarily. Wait 15 seconds between each operation of the starter to let it cool and the battery power recover.

NOTE

- *The motorcycle is equipped with a starter lockout switch. This switch is designed so that the engine does not start if the transmission is in gear and the side stand is down. However, the engine can be started if the clutch lever is pulled and the side stand is fully up.*

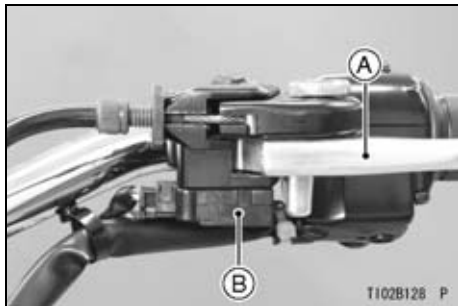

A. Clutch Lever

B. Starter Lockout Switch

NOTICE

Do not let the engine idle longer than five minutes, or engine overheating and damage may occur.

Jump Starting

If your motorcycle battery is “run down,” it should be removed and charged. If this is not practical, a 12 volt booster battery and jumper cables may be used to start the engine.

 **DANGER**

Battery acid generates hydrogen gas which is flammable and explosive under certain conditions. It is present within a battery at all times, even in a discharged condition. Keep all flames and sparks (cigarettes) away from the battery. Wear eye protection when working with a battery. In the event of battery acid contact with skin, eyes, or clothing, wash the affected areas immediately with water for at least 5 minutes. Seek medical attention.

Connecting Jumper Cables

- Remove the seat.
- Make sure the ignition switch is turned to OFF.
- Remove the bracket and move the ECU aside without disconnecting the connectors from the ECU. (Refer to the Battery section of the “Maintenance and Adjustment” chapter.)
- Connect a jumper cable from the positive (+) terminal of the booster battery to the positive (+) terminal of the motorcycle battery.

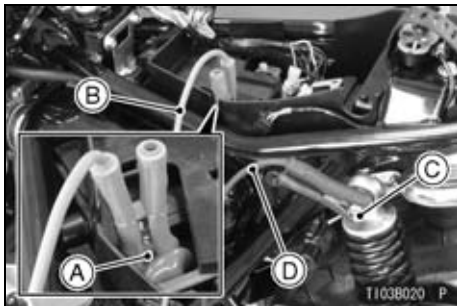

- A. Motorcycle Battery Positive (+) Terminal
- B. From Booster Battery Positive (+) Terminal
- C. Unpainted Metal Surface
- D. From Booster Battery Negative (-) Terminal

- Connect another jumper cable from the negative (-) terminal of the booster battery to your motorcycle rear shock absorber upper mount nut or other unpainted metal surface. Do not use the negative (-) terminal of the battery.

⚠ DANGER

Batteries contain sulfuric acid that can cause burns and produce hydrogen gas which is highly explosive. Do not make this last connection at the fuel system or battery. Take care not to touch the positive and negative cables together, and do not lean over the battery when making this last connection. Do not connect to a frozen battery. It could explode. Do not reverse polarity by connecting positive (+) to negative (-), or a battery explosion and serious damage to the electrical system may occur.

- Follow the standard engine starting procedure.

NOTICE

Do not operate the starter continuously for more than 5 seconds or the starter will overheat and the battery power will drop temporarily. Wait 15 seconds between each operation of the starter to let it cool and the battery power recover.

- After the engine has started, disconnect the jumper cables. Disconnect the negative (–) cable from the motorcycle first.
- Reinstall the parts removed.

Moving Off

- Check that the side stand is up.
- Pull in the clutch lever.
- Shift into 1st gear.
- Open the throttle a little, and start to let out the clutch lever very slowly.
- As the clutch starts to engage, open the throttle a little more, giving the engine just enough fuel to keep it from stalling.

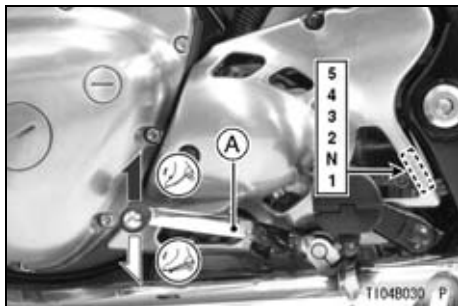

A. Shift Pedal

NOTE

- *The motorcycle is equipped with a side stand switch. This switch is designed so that the engine does not start if the transmission is in gear and the side stand is down.*

Shifting Gears

- Close the throttle while pulling in the clutch lever.
- Shift into the next higher or lower gear.
- Open the throttle half way, while releasing the clutch lever.

WARNING

Downshifting to a lower gear at high speed causes engine rpm to increase excessively, potentially damaging the engine and it may also cause the rear wheel to skid and cause an accident. Downshifting should be done below 5 000 rpm for each gear.

NOTE

- *The transmission is equipped with a positive neutral finder. When the motorcycle is standing still, the transmission cannot be shifted past neutral from 1st gear. To use the positive neutral finder, shift down to 1st gear, then lift up on the shift pedal while standing still. The transmission will shift only into neutral.*

Braking

- Close the throttle completely, leaving the clutch engaged (except when shifting gears) so that the engine will help slow down the motorcycle.
- Shift down one gear at a time so that you are in 1st gear when you come to a complete stop.
- When stopping, always apply both brakes at the same time. Normally the front brake should be applied a little more than the rear. Shift down or fully disengage the clutch as necessary to keep the engine from stalling.

54 HOW TO RIDE THE MOTORCYCLE

- Never lock the brakes, or it will cause the tires to skid. When turning a corner, it is better not to brake at all. Reduce your speed before you get into the corner.
- For emergency braking, disregard downshifting, and concentrate on applying the brakes as hard as possible without skidding.



A. Front Brake Lever

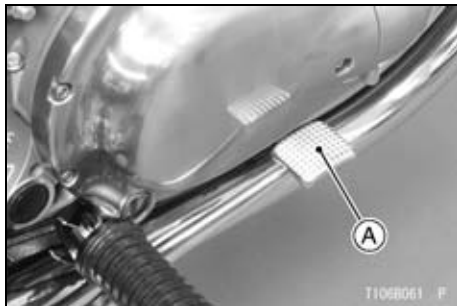

A. Rear Brake Pedal

Stopping the Engine

- Close the throttle completely.
- Shift the transmission into neutral.
- Turn the ignition switch to “OFF”.
- Support the motorcycle on a firm, level surface with the side stand or center stand.
- Lock the steering.

NOTE

- *The motorcycle is equipped with a vehicle-down sensor, which causes the engine to stop automatically.*

Stopping the Motorcycle in an Emergency

Your Kawasaki Motorcycle has been designed and manufactured to provide you optimum safety and convenience. However, in order to fully benefit from Kawasaki's safety engineering and craftsmanship, it is essential that you, the owner and operator, properly maintain your motorcycle and become thoroughly familiar with its operation. Improper maintenance can create a dangerous situation known as throttle failure. Two of the most common causes of throttle failure are:

1. An improperly serviced or clogged air cleaner may allow dirt and dust to enter the throttle body and stick the throttle open.
2. During removal of the air cleaner, dirt is allowed to enter and jam the throttle body.

56 HOW TO RIDE THE MOTORCYCLE

In an emergency situation such as throttle failure, your vehicle may be stopped by applying the brakes and disengaging the clutch. Once this stopping procedure is initiated, the engine stop switch may be used to stop the engine. If the engine stop switch is used, turn off the ignition switch after stopping the motorcycle.

Parking



WARNING

Operating or parking the vehicle near flammable materials can cause a fire, and can result in property damage or severe personal injury.

Do not idle or park your vehicle in an area where tall or dry vegetation, or other flammable materials could come into contact with the muffler or exhaust pipe.

⚠ WARNING

The engine and exhaust system get extremely hot during normal operation and can cause serious burns. Never touch a hot engine, exhaust pipe, or muffler during operation or after stopping the engine.

- Shift the transmission into neutral and turn the ignition switch to “OFF”.
- Support the motorcycle on a firm, level surface with the side stand or center stand.

NOTICE

Do not park on a soft or steeply inclined surface, or the motorcycle may fall over.

- If parking inside a garage or other structure, be sure it is well ventilated

and the motorcycle is not close to any source of flame or sparks; this includes any appliance with a pilot light.

⚠ WARNING

Gasoline is extremely flammable and can be explosive under certain conditions.

- Lock the steering to help prevent theft.

NOTE

- *When stopping near traffic at night, you can leave the taillight on for greater visibility by turning the ignition switch to the P (Park) position.*
- *Do not leave the ignition switch at P position too long, or the battery will discharge.*

Catalytic Converter

This motorcycle is equipped with a catalytic converter in the exhaust system. The converter reacts with carbon monoxide, hydrocarbons and nitrogen oxides to convert them into carbon dioxide, water, nitrogen and oxygen resulting in much cleaner exhaust gases to be discharged into the atmosphere.

For proper operation of the catalytic converter, the following cautions must be observed.

WARNING

Operating or parking the vehicle near flammable materials can cause a fire, and can result in property damage or severe personal injury.

Do not idle or park your vehicle in an area where tall or dry vegetation, or other flammable materials could come into contact with the muffler or exhaust pipe.

WARNING

The engine and exhaust system get extremely hot during normal operation and can cause serious burns. Never touch a hot engine, exhaust pipe, or muffler during operation or after stopping the engine.

- Use only unleaded gasoline. Never use leaded gasoline. Leaded gasoline significantly reduces the capability of the catalytic converter.
- Do not operate the vehicle with the engine or any one cylinder misfiring. Under these conditions unburned

air/fuel mixture flowing out of engine excessively accelerates reaction in the converter allowing the converter to overheat and become damaged when the engine is hot, or reduces converter performance when the engine is cold.

SAFE OPERATION

Safe Riding Technique

The points given below are applicable for everyday motorcycle use and should be carefully observed for safe and effective vehicle operation.

For safety, eye protection and a helmet are strongly recommended. You should be aware of and verify the applicable safety regulations in force prior to riding your motorcycle. Gloves and suitable footwear should also be used for added protection in case of a mishap.

A motorcycle does not provide the impact protection of an automobile, so defensive riding in addition to wearing protective apparel is extremely important. Do not let protective apparel give you a false sense of security.

When riding always keep both hands on the handlebars and both feet on the footpegs. Removing your hands from the handlebars or feet from the footpegs while riding can be hazardous. If you remove even one hand or foot, you can reduce your ability to control the motorcycle.

Before changing lanes, look over your shoulder to make sure the way is clear. Do not rely solely on the rear view mirror; you may misjudge a vehicle's distance and speed, or you may not see it at all.

In general your actions should be smooth as sudden acceleration, braking or turning may cause loss of control, especially when riding in wet conditions or on loose roadway surfaces, when the ability to maneuver will be reduced.

When going up steep slopes, shift to a lower gear so that there is plenty of power to spare rather than overloading the engine.

When applying the brakes, use both the front and rear brakes. Applying only one brake for sudden braking may cause the motorcycle to skid and lose control.

When going down long slopes, control vehicle speed by closing the throttle. Use the front and rear brakes for auxiliary braking.

In wet conditions, rely more on the throttle to control vehicle speed and less on the front and rear brakes. The throttle should also be used judiciously to avoid skidding the rear wheel from too rapid acceleration or deceleration.

Riding at the proper rate of speed and avoiding unnecessarily fast acceleration are important not only for safety and low fuel consumption but also for long vehicle life and quieter operation.

On rough roads, exercise caution, slow down, and grip the fuel tank with the knees for better stability.

When quick acceleration is necessary as in passing, shift to a lower gear to obtain the necessary power.

62 SAFE OPERATION

Do not downshift at too high an r/min (rpm) to avoid damage to the engine from overrevving.

Avoiding unnecessary weaving is important to the safety of both the rider and other motorists.

Daily Checks

Check the following items each day before you ride. The time required is minimal, and habitual performance of these checks will help ensure you a safe, reliable ride.

If any irregularities are found during these checks, refer to the Maintenance and Adjustment chapter or see your dealer for the action required to return the motorcycle to a safe operating condition.

WARNING

Failure to perform these checks before operation may result in serious damage or an accident. Always perform daily checks before operation.

DANGER

Exhaust gas contains carbon monoxide, a colorless, odorless poisonous gas. Inhaling carbon monoxide can cause serious brain injury or death. DO NOT run the engine in enclosed areas. Operate only in a well-ventilated area.

Fuel Adequate supply in tank, no leaks.
 Engine oil Oil level between level lines.

64 SAFE OPERATION

Tires Air pressure (when cold):

Front	Up to 183 kg (403 lb) Load	200 kPa (2.00 kgf/cm ² , 28 psi)
Rear	Up to 97.5 kg (215 lb) Load	225 kPa (2.25 kgf/cm ² , 32 psi)
	97.5 ~ 183 kg (215 ~ 403 lb) Load	250 kPa (2.50 kgf/cm ² , 36 psi)

Install the air valve cap.

Drive chain Slack 25 ~ 35 mm (1.0 ~ 1.4 in.)

Lubricate the drive chain if dry.

Nuts, bolts, fasteners .. Check that steering and suspension components, axles, and all controls are properly tightened or fastened.

Steering Action smooth but not loose from lock to lock. No binding of control cables.

Brakes Brake pad wear: Lining thickness more than 1 mm (0.04 in.) left. No brake fluid leakage.

Throttle Throttle grip play 2 ~ 3 mm (0.08 ~ 0.12 in.).

Clutch Clutch lever play 2 ~ 3 mm (0.08 ~ 0.12 in.). Clutch lever operates smoothly.

Electrical equipment ... All lights (Headlight, Tail/Brake Lights, Turn Signal Lights, Warning/Indicator Lights) and horn work.

Engine stop switch Stops engine.

Side stand and center

stand Returns to their fully up position by spring tension. Returns
springs not weak or not damaged.

Additional Considerations for High Speed Operation

Brakes: The importance of the brakes, especially during high speed operation, cannot be overemphasized. Check to see that they are correctly adjusted and functioning properly.

Steering: Looseness in the steering can cause loss of control. Check to see that the handlebar turns freely but has no play.

Tires: High speed operation is hard on tires, and good tires are crucial for riding safety. Examine their overall condition, inflate them to the proper pressure, and check the wheel balance.

Fuel: Have sufficient fuel for the high fuel consumption during high speed operation.

Engine Oil: To avoid engine seizure and resulting loss of control, make sure that the oil level is at the upper level line.

Electrical Equipment: Make sure that the headlight, tail/brake light, turn signals, horn, etc., all work properly.

Miscellaneous: Make sure that all nuts and bolts are tight and that all safety related parts are in good condition.

 **WARNING**

Handling characteristics of a motorcycle at high speeds may vary from those you are familiar with at legal highway speeds. Do not attempt high speed operation unless you have received sufficient training and have the required skills.

MAINTENANCE AND ADJUSTMENT

The maintenance and adjustments outlined in this chapter must be carried out and must be done in accordance with the Periodic Maintenance Chart to keep the motorcycle in good running condition. **The initial maintenance is vitally important and must not be neglected.**

With a basic knowledge of mechanics and the proper use of tools, you should be able to carry out many of the maintenance items described in this chapter. If you lack proper experience or doubt your ability, all adjustments, maintenance, and repair work should be completed by a qualified technician.

Please note that Kawasaki cannot assume any responsibility for damage resulting from incorrect or improper adjustment done by the owner.

Periodic Maintenance Chart

K: Should be serviced by an authorized Kawasaki dealer.

*: For higher odometer readings, repeat at the frequency interval established here.

#: Service more frequently when operating in severe conditions: dusty, wet, muddy, high speed, or frequent starting/stopping.

1. Periodic Inspection (Engine Related Items)

Operation (Engine Items)	Frequency	Whichever comes first →							*Odometer Reading km × 1 000 (mile × 1 000)	See Page
		↓	1 (0.6)	6 (3.75)	12 (7.5)	18 (11.25)	24 (15)	30 (18.75)		
	Every									
Air cleaner element - clean				●		●		●	86	
K Valve clearance - inspect				●		●		●	86	
Throttle control system (play, smooth return, no drag) - inspect	year	●		●		●		●	91	
K Engine vacuum synchronization - inspect				●		●		●	93	
Idle speed - inspect		●		●		●		●	94	
Fuel leak (fuel hose and pipe) - inspect	year	●		●		●		●	—	

70 MAINTENANCE AND ADJUSTMENT

Operation (Engine Items)	Frequency	Whichever comes first → ↓ *Odometer Reading km × 1 000 (mile × 1 000)							See Page
		Every	1 (0.6)	6 (3.75)	12 (7.5)	18 (11.25)	24 (15)	30 (18.75)	
Fuel hoses damage - inspect	year	•		•		•		•	–
Fuel hoses installation condition - inspect	year	•		•		•		•	–
K Air suction system damage - inspect				•		•		•	85

2. Periodic Inspection (Chassis Related Items)

Operation (Chassis Items)	Frequency	Whichever comes first →							*Odometer Reading km × 1000 (mile × 1000)	See Page
	Every	1 (0.6)	6 (3.75)	12 (7.5)	18 (11.25)	24 (15)	30 (18.75)	36 (22.5)		
Clutch and drive train:										
K Clutch operation (play, engagement, disengagement) - inspect		•		•		•		•		95
Drive chain lubrication condition - inspect #	every 600 km (400 mile)								104	
Drive chain slack - inspect #	every 1 000 km (600 mile)								97	
Drive chain wear - inspect #				•		•		•	102	
K Drive chain guide wear - inspect				•		•		•	–	

74 MAINTENANCE AND ADJUSTMENT

Frequency	Whichever comes first →								See Page
	*Odometer Reading km × 1000 (mile × 1000)								
Operation (Chassis Items)	Every	1	6	12	18	24	30	36	
		(0.6)	(3.75)	(7.5)	(11.25)	(15)	(18.75)	(22.5)	
Brake lining wear - inspect #			•	•	•	•	•	•	105
Brake light switch operation - inspect		•	•	•	•	•	•	•	110
Suspensions:									
Front forks/rear shock absorbers operation (damping and smooth stroke) - inspect				•		•		•	112, 113
Front forks/rear shock absorbers oil leak - inspect	year			•		•		•	112, 113
K Swingarm pivot lubricate						•			—

Frequency	Whichever comes first →								See Page
	*Odometer Reading km × 1000 (mile × 1000)								
Operation (Chassis Items)	Every	1	6	12	18	24	30	36	
		(0.6)	(3.75)	(7.5)	(11.25)	(15)	(18.75)	(22.5)	
Steering System:									
K Steering play - inspect	year	●		●		●		●	–
K Steering stem bearings - lubricate	2 years					●			–
Electrical System:									
Lights and switches operation - inspect	year			●		●		●	–
Headlight aiming - inspect	year			●		●		●	127
Side stand switch operation - inspect	year			●		●		●	–
Engine stop switch operation - inspect	year			●		●		●	–

76 MAINTENANCE AND ADJUSTMENT

Operation (Chassis Items)	Frequency	Whichever comes first →							*Odometer Reading km × 1000 (mile × 1000)	See Page
		↓	1	6	12	18	24	30		
	Every	(0.6)	(3.75)	(7.5)	(11.25)	(15)	(18.75)	(22.5)		
Chassis:										
K Chassis parts - lubricate	year			•		•		•	-	
K Bolts and nuts tightness - inspect		•		•		•		•	-	

3. Periodic Replacement

Change/Replacement Items	Frequency	*Odometer Reading km × 1 000 (mile × 1 000)					See Page
	Whichever comes first ↓	1 (0.6)	12 (7.5)	24 (15)	36 (22.5)	48 (30)	
K Air cleaner element - replace #	2 years						86
Engine oil - change #	year	●	●	●	●	●	80
Oil filter - replace	year	●	●	●	●	●	80
K Fuel hoses - replace	5 years						—
K Brake hoses - replace	4 years						—
K Brake fluid (front) - change	2 years			●		●	108
K Rubber parts of master cylinder and caliper - replace	4 years					●	—
K Spark plug - replace			●	●	●	●	84

Engine Oil

In order for the engine, transmission, and clutch to function properly, maintain the engine oil at the proper level, and change the oil and replace the oil filter in accordance with the Periodic Maintenance Chart. Not only do dirt and metal particles collect in the oil, but the oil itself loses its lubricative quality if used too long.

WARNING

Motorcycle operation with insufficient, deteriorated, or contaminated engine oil will cause accelerated wear and may result in engine or transmission seizure, accident, and injury. Check the oil level before each ride and change the oil according to the periodic maintenance chart in the owner's manual.

Oil Level Inspection

- If the oil has just been changed, start the engine and run it for several minutes at idle speed. This fills the oil filter with oil. Stop the engine, then wait several minutes until the oil settles.

NOTICE

Racing the engine before the oil reaches every part can cause engine seizure.

- If the motorcycle has just been used, wait several minutes for all the oil to drain down.

- Check the engine oil level through the oil level inspection window. With the motorcycle held level, the oil level should come up between the upper and lower level lines next to the oil level inspection window.

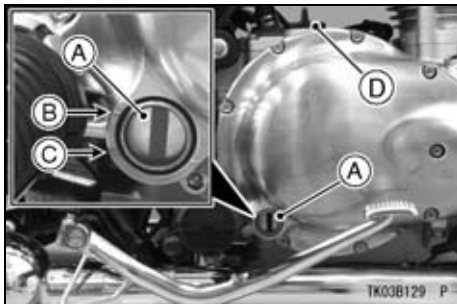

- A. Oil Level Inspection Window
- B. Upper Level Line
- C. Lower Level Line
- D. Oil Filler Cap

- If the oil level is too high, remove the excess oil through the oil filler opening using a syringe or some other suitable device.
- If the oil level is too low, add the oil to reach the correct level. Use the same type and brand of oil that is already in the engine.

NOTICE

If the engine oil gets extremely low or if the oil pump does not function properly or oil passages are clogged, the warning indicator light will light. If it stays on when the engine speed is above idle, stop the engine immediately and have it serviced. Failure to do so could cause serious engine damage.

80 MAINTENANCE AND ADJUSTMENT

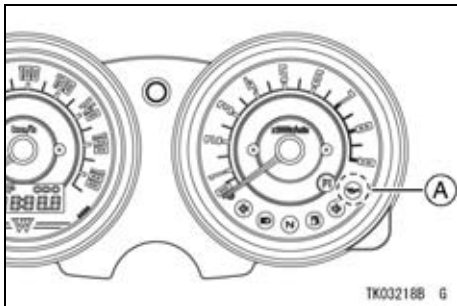

A. Oil Pressure Warning Indicator Light

Oil and/or Oil Filter Change

- Warm up the engine thoroughly, and then stop it.
- Place an oil pan beneath the engine.

- Remove the engine oil drain bolt.



A. Engine Oil Drain Bolt

- Let the oil completely drain with the motorcycle perpendicular to the ground.

⚠ WARNING

Engine oil is a toxic substance. Dispose of used oil properly. Contact your local authorities for approved disposal methods or possible recycling.

- If the oil filter is to be replaced, remove the oil filter cover.

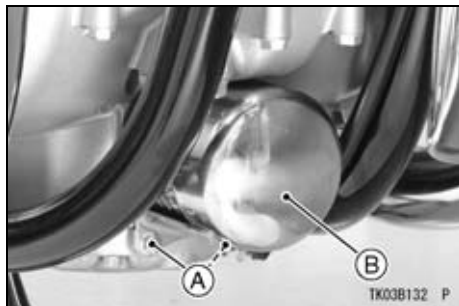

- A. Bolts
- B. Oil Filter Cover

- Remove the oil filter cartridge and replace it with a new one.

NOTE

- *If a torque wrench or required Kawasaki special tool is not available, this item should be serviced by an authorized Kawasaki dealer.*



A. Oil Filter

82 MAINTENANCE AND ADJUSTMENT

- Apply a thin film of oil to the packing and tighten the cartridge to the specified torque.

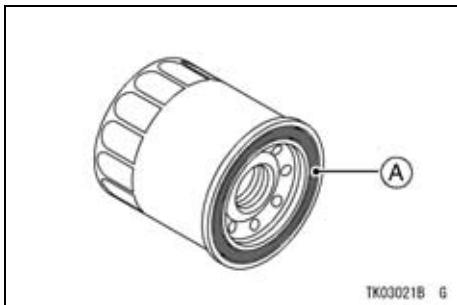

A. Packing

- Install the oil filter cover.
- Install the drain bolt with a new gasket. Tighten it to the specified torque.

NOTE

- *Replace any gaskets with new ones.*

Tightening Torque

Engine Oil Drain Bolt:

20 N·m (2.0 kgf·m, 15 ft·lb)

Oil Filter:

18 N·m (1.8 kgf·m, 13 ft·lb)

Oil Filter Cover Mounting Bolts:

12 N·m (1.2 kgf·m, 106 in·lb)

Recommended Engine Oil

Type:

API SG, SH, SJ, SL or SM with JASO
MA, MA1 or MA2

Viscosity:

SAE10W-40

NOTE

- *Do not add any chemical additive to the oil. Oils fulfilling the above requirements are fully formulated and provide adequate lubrication for both the engine and the clutch.*

Engine Oil Capacity

Capacity:

- 2.7 L (2.9 US qt)
(when filter is not removed)
- 2.9 L (3.1 US qt)
(when filter is removed)
- 3.2 L (3.4 US qt)
(when engine is completely dry)

Although 10W-40 engine oil is the recommended oil for most conditions, the oil viscosity may need to be changed to accommodate atmospheric conditions in your riding area.

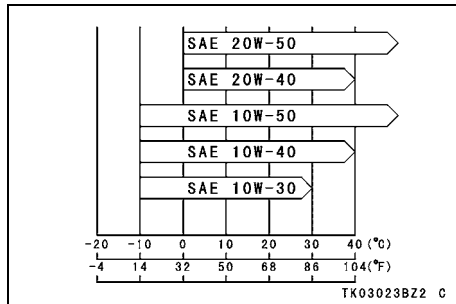

84 MAINTENANCE AND ADJUSTMENT

Spark Plugs

The standard spark plug is shown in the table. The spark plugs should be replaced in accordance with the Periodic Maintenance Chart.

Spark plug removal should be done only by an authorized Kawasaki dealer.

Spark Plug

Standard Plug	NGK CR8E
Plug Gap	0.7 ~ 0.8 mm (0.028 ~ 0.032 in.)
Tightening Torque	13 N·m (1.3 kgf·m, 115 in·lb)

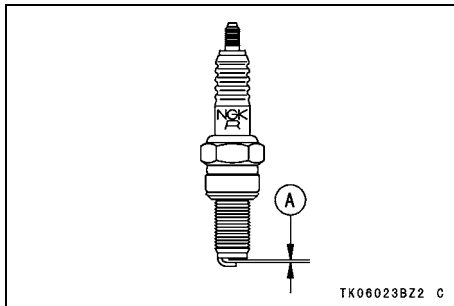

A. Plug Gap

Kawasaki Clean Air System

The Kawasaki Clean Air System (KCA) is a secondary air suction system that helps the exhaust gases to burn more completely. When the spent fuel charge is released into the exhaust system, it is still hot enough to burn. The KCA System allows extra air into the exhaust system so that the spent fuel charge can continue to burn. This continued burning action tends to burn up a great deal of the normally unburned gases, as well as changing a significant portion of the carbon monoxide into carbon dioxide.

Air Suction Valves -

The air suction valve is essentially a check valve which allows fresh air to flow only from the air cleaner into the exhaust port. Any air that has passed the air suction valve is prevented from returning. Inspect the air suction valves in accordance with the Periodic Maintenance Chart. Also, inspect the air suction valves whenever stable idling cannot be obtained, engine power is greatly reduced, or there are abnormal engine noises.

Air suction valve removal and inspection should be done only by an authorized Kawasaki dealer.

Valve Clearance

Valve and valve seat wear decreases valve clearance, upsetting valve timing.

NOTICE

If valve clearance is left unadjusted, wear will eventually cause the valves to remain partly open, which lowers performance, burns the valves and valve seats, and may cause serious engine damage.

Valve clearance for each valve should be checked and adjusted in accordance with the Periodic Maintenance Chart.

Inspection and adjustment should be done only by an authorized Kawasaki dealer.

Air Cleaner

A clogged air cleaner restricts the engine's air intake, increasing fuel consumption, reducing engine power, and causing spark plug fouling.

The air cleaner element must be cleaned in accordance with the Periodic Maintenance Chart. In dusty areas, the element should be cleaned more frequently than the recommended interval. After riding through rain or on muddy roads, the element should be cleaned immediately. The element should be replaced if it is damaged.

Element Removal

- Remove the seat.
- Remove the screws on the left side cover.

- Remove the left side cover from the projection by pushing the side cover forward and pulling it outward.

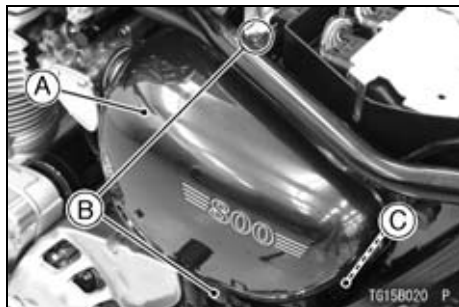

- A. Left Side Cover
- B. Screws
- C. Projection

- Remove the screws and right side cover.

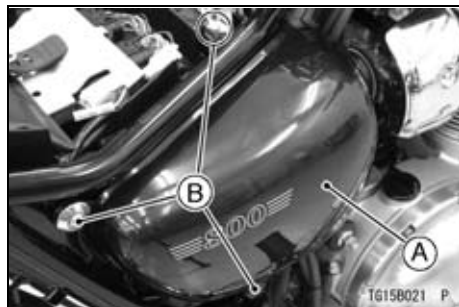

- A. Right Side Cover
- B. Screws

88 MAINTENANCE AND ADJUSTMENT

- Pull out the air cleaner elements from both side of the air cleaner housing.



A. Element

- Put a clean, lint-free towel into the air cleaner housing to keep dirt or other foreign material from entering.

NOTE

- *Do not try to separate the element material and frame for cleaning.*

- Inspect the element material for damage. If any part of the element is damaged, the element must be replaced.

⚠ WARNING

If dirt or dust is allowed to pass through into the throttle body assembly, the throttle may become stuck, possibly causing accident. Be sure to keep the dust from entering during cleaning.

NOTICE

If dirt gets through into the engine, excessive engine wear and possibly engine damage will occur.

Element Cleaning

- Clean the element in a bath of a high flash-point solvent.
- Squeeze it dry in a clean towel. Do not wring the element or blow it dry; the element can be damaged.
- Check all the parts of the element for visible damage.
- If any of the parts of the element are damaged, replace them.
- After cleaning, saturate the element with a high-quality foam-air-filter oil, squeeze out the excess, then wrap it in a clean towel and squeeze it as dry as possible.
- Be careful not to tear the sponge filter.

NOTE

- *Element installation is performed in the reverse order of removal.*

- *Be sure to install the element with the wire net facing up.*

WARNING

Gasoline and low flash-point solvents are extremely flammable and may explode, causing severe burns. Do not use gasoline or a low flash-point solvent to clean the element. Clean the element in a well-ventilated area. Be sure there are no sparks or flame in the work area, including any appliance with a pilot light.

90 MAINTENANCE AND ADJUSTMENT

Oil Draining

- Inspect the drain hose located on the right side of the engine to see if any oil or water has run down from the air cleaner housing.

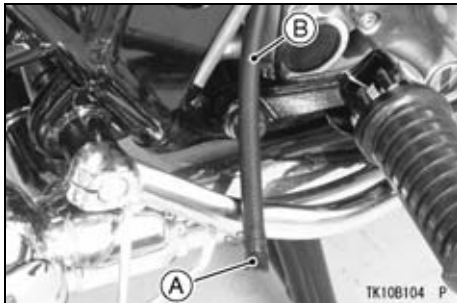

A. Plug

B. Drain Hose

- If there is any oil in the hose, remove the plug and drain the oil.

⚠ WARNING

Oil on tires will make them slippery and can cause an accident and injury. Be sure to install the plug in the drain hose after draining.

Throttle Control System

Check the throttle grip play in accordance with the Periodic Maintenance Chart, and adjust it if necessary.

Throttle Grip -

The throttle grip controls the butterfly valves in the throttle body. If the throttle grip has excessive play due to either cable stretch or maladjustment, it will cause a delay in throttle response, especially at low engine speed. Also, the throttle valve may not open fully at full throttle. On the other hand, if the throttle grip has not play, the throttle will be hard to control, and the idle speed will be erratic.

Inspection

- Check that the throttle grip play is correct by lightly turning the throttle grip back and forth.

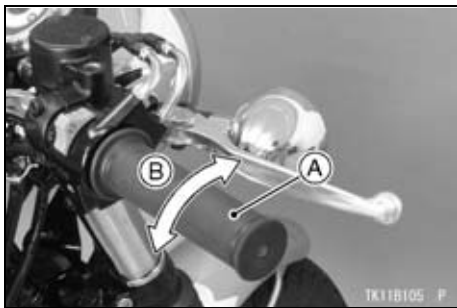

- A. Throttle Grip
- B. Throttle Grip Play

Throttle Grip Play

2 ~ 3 mm (0.08 ~ 0.12 in.)

- If there is improper play, adjust it.

92 MAINTENANCE AND ADJUSTMENT

Adjustment

- Loosen the locknuts at the upper of the throttle cables, and screw both throttle cable adjusters completely so as to give the throttle grip plenty of play.
- Turn out the decelerator cable adjuster until it has no play when the throttle grip is completely closed. Tighten the locknut.
- Turn out the accelerator cable adjuster until the throttle grip has the proper play. Tighten the locknut.

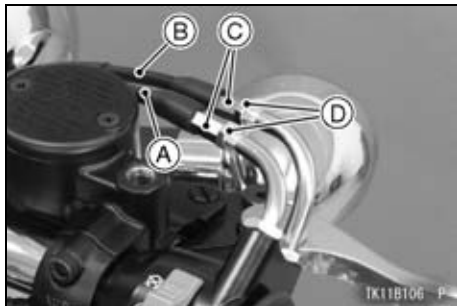

- A. Accelerator Cable**
- B. Decelerator Cable**
- C. Adjuster**
- D. Locknuts**

- If the throttle cables cannot be adjusted with the adjuster at the upper of the throttle cable, further adjustment of the throttle cables should be done by an authorized Kawasaki dealer.

- With the engine idling, turn the handlebar to each side. If handlebar movement changes the idle speed, the throttle cables may be improperly adjusted or incorrectly routed, or they may be damaged. Be sure to correct any of these conditions before idling.

 **WARNING**

Operation with improperly adjusted, incorrectly routed, or damaged cables could result in an unsafe riding condition. Be sure the control cables are adjusted and routed correctly, and are free from damage.

Engine Vacuum Synchronization

Engine vacuum synchronization must be checked and adjusted periodically in accordance with the Periodic Maintenance Chart by an authorized Kawasaki dealer.

NOTE

- *Poor engine vacuum synchronization will cause unstable idling, sluggish throttle response, and reduce engine power and performance.*

94 MAINTENANCE AND ADJUSTMENT

Idle Speed

The idle speed adjustment should be performed in accordance with the Periodic Maintenance Chart or whenever the idle speed is disturbed.

Adjustment

- Start the engine, and warm it up thoroughly.
- Adjust the idle speed by turning the idle adjusting screw.

NOTE

- *While the engine is cold, the fast idle system automatically raises the engine idling speed.*

Idle Speed

1 150 ~ 1 250 r/min (rpm)

WARNING

The engine gets extremely hot during normal operation and can cause serious burns. Never touch a hot engine.

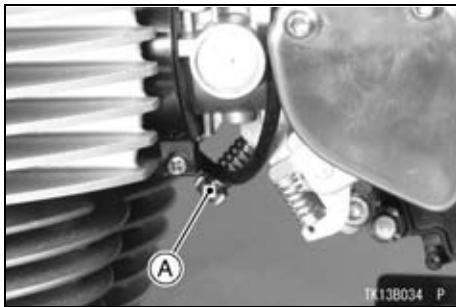

A. Idle Adjusting Screw

- Open and close the throttle a few times to make sure that the idle speed does not change. Readjust if necessary.

- With the engine idling, turn the handlebar to each side. If handlebar movement changes the idle speed, the throttle cables may be improperly adjusted or incorrectly routed, or they may be damaged. Be sure to correct any of these conditions before riding.

 **WARNING**

Operation with damaged cables could result in an unsafe riding condition. Replace damaged control cables before operation.

Clutch

Due to friction plate wear and clutch cable stretch over a long period of use, the clutch operation should be checked each day before riding the motorcycle, and in accordance with the Periodic Maintenance Chart.

Inspection

- Check that the clutch lever operates properly and that the inner cable slides smoothly. If there is any irregularity, have the clutch cable checked by an authorized Kawasaki dealer.
- Check the clutch lever play as shown in the figure.

Clutch Lever Play

2 ~ 3 mm (0.08 ~ 0.12 in.)

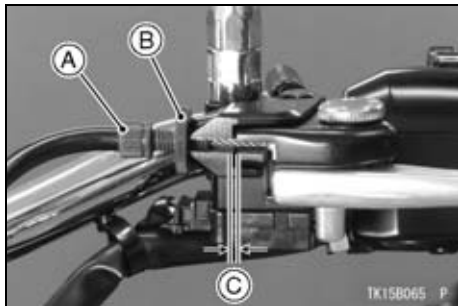

- A. Adjuster
- B. Locknut
- C. Clutch Lever Play

If the play is incorrect, adjust the lever play as follows.

Adjustment

- Loosen the locknut at the clutch lever.
- Turn the adjuster so that the clutch lever will have the specified free play.

⚠ WARNING

Too much cable play can prevent clutch disengagement and cause an accident resulting in serious injury or death. When adjusting the clutch or replacing the cable, be sure the upper end of the clutch outer cable is fully seated in its fitting, or it could slip into place later, creating enough cable play to prevent clutch disengagement.

- Tighten the locknut.

NOTE

- *After the adjustment is made, start the engine and check that the clutch does not slip and that it releases properly.*

Drive Chain

The drive chain slack and lubrication must be checked each day before riding the motorcycle, and in accordance with the Periodic Maintenance Chart for safety and to prevent excessive wear. If the chain becomes badly worn or maladjusted - either too loose or too tight - the chain could jump off the sprockets or break.

WARNING

A chain that breaks or jumps off the sprockets could snag on the engine sprocket or lock the rear wheel, severely damaging the motorcycle and causing it to go out of control. Inspect the chain for damage and proper adjustment before each ride.

Chain Slack Inspection

- Set the motorcycle up on its side stand.
- Rotate the rear wheel to find the position where the chain is tightest, and measure the maximum chain slack by pulling up and pushing down the chain midway between the engine sprocket and rear wheel sprocket.

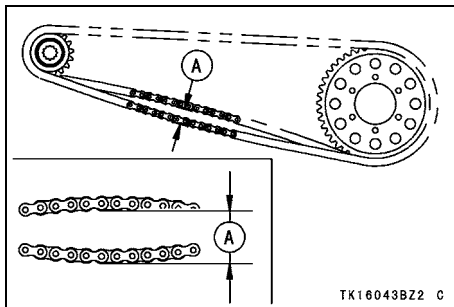

A. Chain Slack

TK16043BZ2 C

98 MAINTENANCE AND ADJUSTMENT

- If the drive chain is too tight or too loose, adjust it so that the chain slack will be within the standard value.

Drive Chain Slack

Standard	25 ~ 35 mm (1.0 ~ 1.4 in.)
----------	----------------------------

NOTE

- *Do not use the center stand for chain slack inspection.*

Chain Slack Adjustment

- Remove the cotter pin from the torque link nut, and loosen the torque link nut.
- Loosen the left and right chain adjuster locknuts.
- Remove the cotter pin, and loosen the rear axle nut.

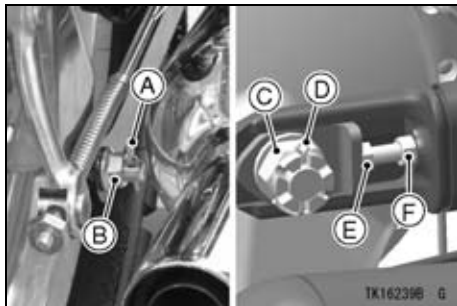

- A. Torque Link Nut
- B. Cotter Pin
- C. Axle Nut
- D. Cotter Pin
- E. Adjusting Bolt
- F. Locknut

- If the chain is too loose, turn out the left and right chain adjusting bolts evenly.
- If the chain is too tight, turn in the left and right chain adjusting bolts evenly.

- Turn both chain adjusting bolts evenly until the drive chain has the correct amount of slack.
- To keep the chain and wheel properly aligned, the notch on the left wheel alignment indicator should align with the same swingarm mark that the right indicator notch aligns with.

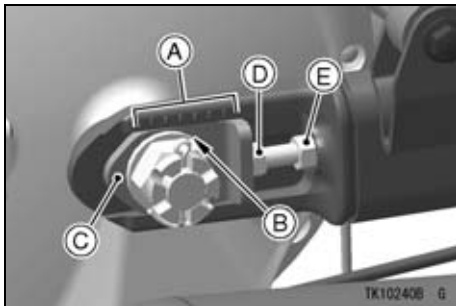

- A. Marks
- B. Notch
- C. Indicator
- D. Adjusting Bolt
- E. Locknut

NOTE

- *Wheel alignment can also be checked using the straightedge or string method.*

 **WARNING**

Misalignment of the wheel will result in abnormal wear, and may result in an unsafe riding condition. Align the rear wheel using the marks on the swingarm or measuring the distance between the center of the axle and swingarm pivot.

- Tighten both chain adjuster locknuts.
- Tighten the rear axle nut to the specified torque.

Tightening Torque

Axle Nut:

98 N·m (10 kgf·m, 72 ft·lb)

NOTE

- *If a torque wrench is not available, this item should be serviced by an authorized Kawasaki dealer.*
- Rotate the wheel, measure the chain slack again at the tightest position, and readjust if necessary.
- Tighten the torque link nut.

Tightening Torque

Torque Link Nut:

34 N·m (3.5 kgf·m, 25 ft·lb)

- Install a new cotter pin through the torque link bolt, and bend its ends.
- Install a new cotter pin through the rear axle nut and axle, and spread its ends.

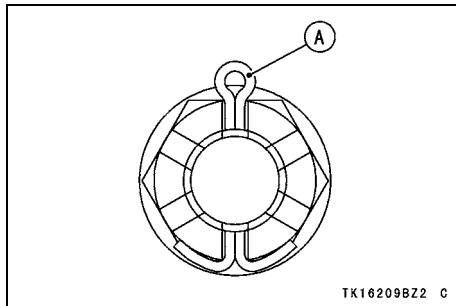

A. Cotter Pin

NOTE

- *When inserting the cotter pin, if the slots in the nut do not align with the cotter pin hole in the axle shaft, tighten the nut clockwise up to the next alignment.*
- *It should be within 30 degrees.*
- *Loosen once and tighten again when the slot goes past the nearest hole.*

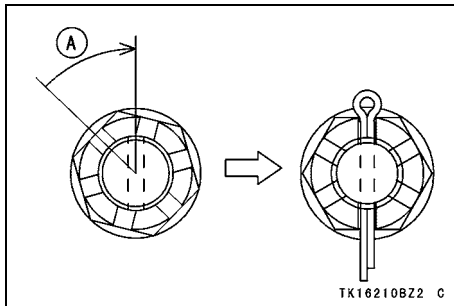

A. Turning Clockwise

⚠ WARNING

A loose axle nut can lead to an accident resulting in serious injury or death. Tighten the axle nut to the proper torque and install a new cotter pin.

- Check the rear brake (see the Brakes section).

102 MAINTENANCE AND ADJUSTMENT

Wear Inspection

- Remove the bolts and washers to take off the chain cover.

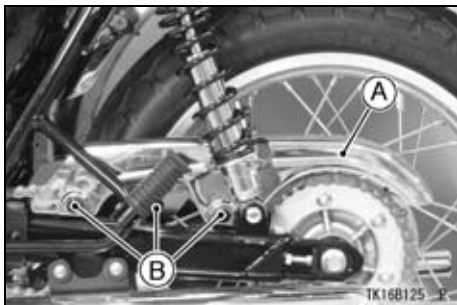

- A. Chain Cover
- B. Bolts and Washers

- Stretch the chain taut either by using the chain adjusters, or by hanging a 10 kg (22 lb) weight on the chain.
- Measure the length of 20 links on the straight part of the chain from pin center of the 1st pin to pin center of

the 21st pin. Since the chain may wear unevenly, take measurements at several places.

- If the length exceeds the service limit, the chain should be replaced.

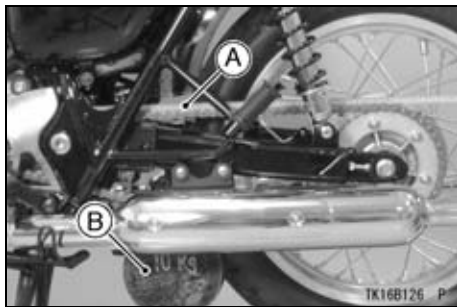

- A. Measure
- B. Weight

Drive Chain 20-Link Length

Service Limit	319 mm (12.56 in.)
---------------	--------------------

⚠ WARNING

For safety, use only the standard chain. It is an endless type and should not be cut for installation; have it installed by an authorized Kawasaki dealer.

- Rotate the rear wheel to inspect the drive chain for damaged rollers, and loose pins and links.
- Also inspect the sprockets for unevenly or excessively worn teeth, and damaged teeth.

NOTE

- *Sprocket wear is exaggerated for illustration. See Service Manual for wear limits.*

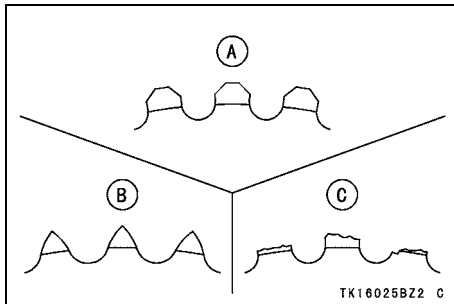

- A. Good Teeth**
- B. Worn Teeth**
- C. Damaged Teeth**

- If there is any irregularity, have the drive chain and/or the sprockets replaced by an authorized Kawasaki dealer.
- Install the chain cover.

104 MAINTENANCE AND ADJUSTMENT

Lubrication

Lubrication is necessary after riding through rain or on wet roads, or any time that the chain appears dry.

Use a lubricant for sealed chains to prevent deterioration of chain seals. If the chain is especially dirty, clean it using a cleaner for sealed chains following the instructions supplied by the chain cleaner manufacturer.

- Apply lubricant to the sides of the rollers so that it will penetrate to the rollers and bushings. Apply lubricant to the seals so that the seals will be coated with lubricant. Wipe off any excess lubricant.

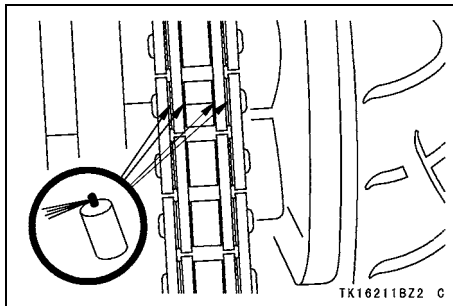

- Wipe off any lubricant that gets on the tire surface.

Brakes

Brake Pads Wear Inspection

Inspect the front disc brake pads for wear. If the thickness of either pad is less than 1 mm (0.04 in.), replace both pads as a set. Pad replacement should be done by an authorized Kawasaki dealer.

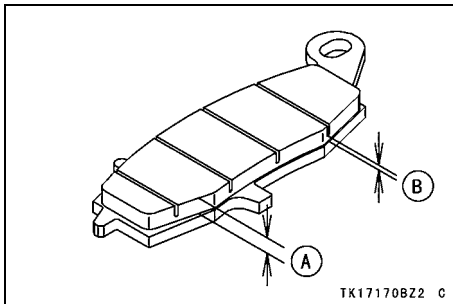

A. Lining Thickness

B. 1 mm (0.04 in.)

Brake Lining Wear Inspection

Inspect the rear brake lining for wear with the brake lining wear indicator on the rear brake panel. If the brake lining wear indicator does not point within the **USABLE RANGE** when the brake is fully applied, the brake shoe linings have worn past the service limit.

In this case, the brake shoes must be replaced, and the drum and other brake parts examined by an authorized Kawasaki dealer.

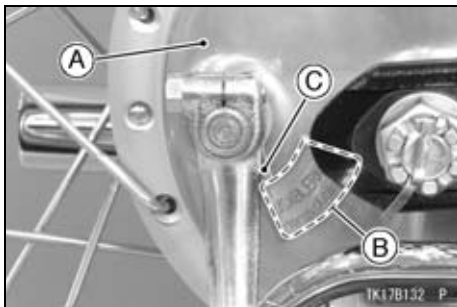

- A. Rear Brake Panel
- B. USABLE RANGE
- C. Brake Lining Wear Indicator

Front Disk Brakes -

Disc and disc pad wear is automatically compensated for and has no effect on the brake lever or pedal action. So there are no parts that require adjustment on the front brake.

⚠ WARNING

Air in the brake lines diminish braking performance and can cause an accident resulting in injury or death. If the brake lever or pedal feels mushy when it is applied, there might be air in the brake lines or the brake may be defective. Have the brake checked immediately by an authorized Kawasaki dealer.

Brake Fluid -

In accordance with the Periodic Maintenance Chart, inspect the brake fluid level in the front brake fluid reservoir and change the brake fluid. The brake fluid should also be changed if it becomes contaminated with dirt or water.

Fluid Requirement

Use heavy-duty brake fluid only from a container marked DOT4.

NOTICE

Do not spill brake fluid onto any painted surface.

Do not use fluid from a container that has been left open or that has been unsealed for a long time.

Check for fluid leakage around the fittings.

Check brake hose for damage.

Fluid Level Inspection

- With the front brake fluid reservoir held horizontal, the brake fluid level in the front brake fluid reservoir must be kept above the lower level line (lower level mark).

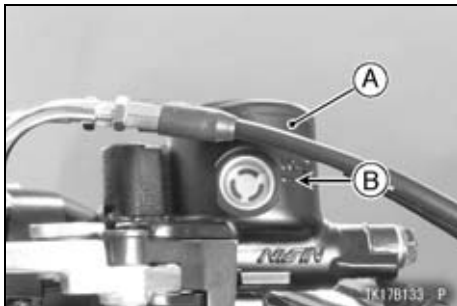

A. Front Brake Fluid Reservoir

B. Lower Level Mark

108 MAINTENANCE AND ADJUSTMENT

- If the fluid level in front brake fluid reservoir is lower than the lower level line, check for fluid leaks in the brake lines, and fill the reservoir to the upper level line. Inside the front brake fluid reservoir is a stepped line showing the upper level line.

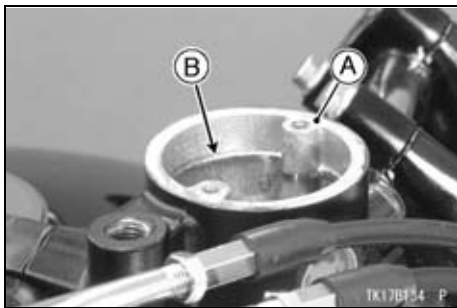

A. Front Brake Fluid Reservoir
B. Upper Level Line

⚠ WARNING

Mixing brands and types of brake fluid can reduce the brake system's effectiveness and cause an accident resulting in injury or death. Do not mix two brands of brake fluid. Change the brake fluid in the brake line completely if the brake fluid must be refilled but the type and brand of the brake fluid that is already in the reservoir are unidentified.

Fluid Change

Have the brake fluid changed by an authorized Kawasaki dealer.

Rear Drum Brake -

In accordance with the Periodic Maintenance Chart, inspect the brake pedal play.

Brake Pedal Play Inspection

- The brake pedal should have the correct pedal play when the pedal is pushed down lightly by hand.

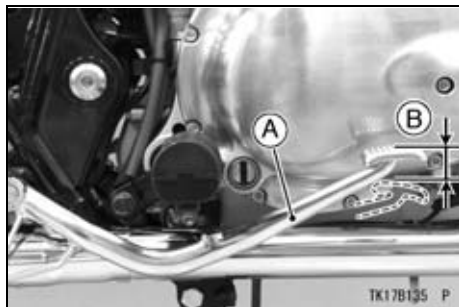

- A. Brake Pedal
- B. Pedal Play

Pedal Play

20 ~ 30 mm (0.8 ~ 1.2 in.)

- If the pedal has improper play, adjust it.

- Rotate the rear wheel to check for brake drag with the pedal released.
- Operate the pedal a few times to see that it returns to its rest position immediately upon release.
- Check braking effectiveness.

Brake Pedal Play Adjustment

- Turn the adjusting nut at the brake cam lever so that the pedal has the correct pedal play.



- A. Adjusting Nut

Brake Light Switch

When either the front or rear brake is applied, the brake light goes on. The front brake light switch requires no adjustment, but the rear brake light switch should be adjusted in accordance with the Periodic Maintenance Chart.

Inspection

- Turn the ignition switch to "ON".
- The brake light should go on when the front brake is applied.
- If it does not, ask your authorized Kawasaki dealer to inspect the front brake light switch.
- Check the operation of the rear brake light switch by depressing the brake pedal. The brake light should go on after the proper pedal travel.

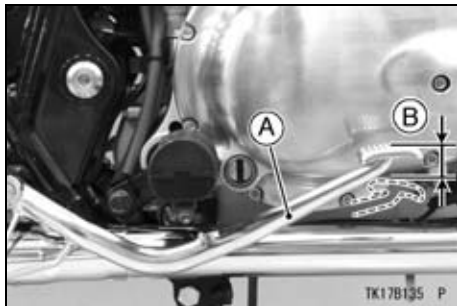

- A. Brake Pedal**
- B. Pedal Travel**

- If it does not, adjust the rear brake light switch.

Brake Pedal Travel

15 mm (0.6 in.)

Adjustment

- To adjust the rear brake light switch, move the switch up or down by turning the adjusting nut.

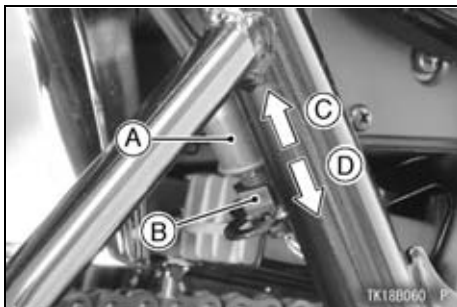

- A. Rear Brake Light Switch
- B. Adjusting Nut
- C. Lights sooner
- D. Lights later

NOTICE

To avoid damaging the electrical connections inside the switch, be sure that the switch body does not turn during adjustment.

Front Fork

The front fork operation and oil leakage should be checked in accordance with the Periodic Maintenance Chart.

Front Fork Inspection

- Holding the brake lever, pump the front fork up and down by several times for inspection of smooth stroke.
- Pull up the dust boots and visually inspect the front fork for oil leakage, scoring or scratches on the outer surface of the inner tube.
- If any doubt about the front fork, it should be done by an authorized Kawasaki dealer.

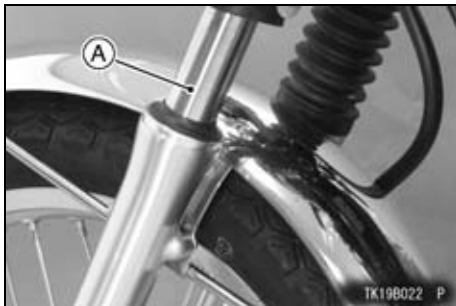

A. Inner Tube

NOTE

- *Set the dust boots with it end fits into the groove on the front fork bottom case.*

Rear Shock Absorber

The rear shock absorbers should be checked for operation and oil leakage in accordance with the Periodic Maintenance Chart.

For various riding or load conditions the rear shock absorbers can be adjusted for Spring preload.

Rear Shock Absorber Inspection

- Press down on the seat several times to inspect the stroke.
- Visually inspect the rear shock absorber for oil leaks.
- If there is any doubt about the rear shock absorber, it should be inspected by an authorized Kawasaki dealer.



A. Rear Shock Absorber

Spring Preload Adjustment

Spring preload can be adjusted by turning the preload adjuster on the rear shock absorber with the screwdriver bit. To increase spring preload and stiffen the suspension, turn the preload adjuster to the left. To decrease preload and soften the suspension, turn the preload adjuster to the right.

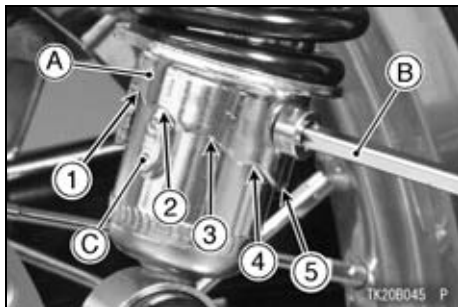

- A. Preload Adjuster
- B. Screwdriver Bit
- C. Stopper

⚠ WARNING

If both spring preload adjusters are not adjusted equally, handling may be impaired and a hazardous condition may result. Set all suspension adjusters equally to the recommended settings.

NOTE

- *Be sure to turn back the preload adjuster to the left from position 5 when softening the spring action.*

Spring Preload Setting

Adjuster Position	1	2	3	4	5
Spring Action	Weak	← Standard →	Strong		
Setting	Soft	← Standard →	Hard		
Load	Light	← Standard →	Heavy		
Road	Good	← Standard →	Bad		
Speed	Low	← Standard →	High		

Wheels

Tires -

Payload and Tire Pressure

Failure to maintain proper inflation pressures or observe payload limits for your tires may adversely affect handling and performance of your motorcycle and can result in loss of control. The maximum recommended load in addition to vehicle weight is 183 kg (403 lb), including rider, passenger, baggage, and accessories.

- Remove the air valve cap.
- Check the tire pressure often, using an accurate gauge.
- Make sure to install the air valve cap securely.

NOTE

- *Measure the tire pressure when the tires are cold (that is, when the motorcycle has not been ridden more than a mile during the past 3 hours).*
- *Tire pressure is affected by changes in ambient temperature and altitude, and so the tire pressure should be checked and adjusted when your riding involves wide variations in temperature or altitude.*

A. Tire Pressure Gauge
Tire Air Pressure (when cold)

Front	Up to 183 kg (403 lb) Load	200 kPa (2.00 kgf/cm ² , 28 psi)
Rear	Up to 97.5 kg (215 lb) Load	225 kPa (2.25 kgf/cm ² , 32 psi)
	97.5 ~ 183 kg (215 ~ 403 lb) Load	250 kPa (2.50 kgf/cm ² , 36 psi)

Tire Wear, Damage

As the tire tread wears down, the tire becomes more susceptible to puncture and failure. An accepted estimate is that 90% of all tire failures occur during the last 10% of tread life (90 % worn). So it is false economy and unsafe to use the tires until they are bald.

- In accordance with the Periodic Maintenance Chart, measure the depth of the tread with a depth gauge, and replace any tire that has worn down to the minimum allowable tread depth.

Minimum Tread Depth

Front	—————	1 mm (0.04 in.)
Rear	Under 130 km/h (80 mph)	2 mm (0.08 in.)
	Over 130 km/h (80 mph)	3 mm (0.12 in.)



A. Tire Depth Gauge

- Visually inspect the tire for cracks and cuts, replacing the tire in case of bad damage. Swelling or high spots indicate internal damage, requiring tire replacement.
- Remove any imbedded stones or other foreign particles from the tread.

NOTE

- *Have the wheel balance inspected whenever a new tire is installed.*

⚠ WARNING

Tires that have been punctured and repaired do not have the same capabilities as undamaged tires and can suddenly fail, causing an accident resulting in serious injury or death. Replace damaged tires as soon as possible. To ensure safe handling and stability, use only the recommended standard tires for replacement, inflated to the standard pressure. If it is necessary to ride on a repaired tire, do not exceed 100 km/h (60 mph) until the tire is replaced.

NOTE

- *When operating on public roadways, keep maximum speed under traffic law limits.*

Standard Tire (Tube-type)

Front	Size: 100/90-19M/C 57H <ul style="list-style-type: none"> ● DUNLOP “TT100GP G”
Rear	Size: 130/80-18M/C 66H <ul style="list-style-type: none"> ● DUNLOP “TT100GP”

 WARNING

Mixing tire brands and types can adversely affect handling and cause an accident resulting in injury or death. Always use the same manufacturer's tires on both front and rear wheels.

 WARNING

New tires are slippery and may cause loss of control and injury. A break-in period of 160 km (100 miles) is necessary to establish normal tire traction. During break-in, avoid sudden and maximum braking and acceleration, and hard cornering.

Spoke and Rim:*Inspection*

Spoke tightness and rim runout should be inspected by an authorized Kawasaki dealer in accordance with the Periodic Maintenance Chart.

Battery

The battery installed in this motorcycle is a sealed type, so it is not necessary to check the battery electrolyte level or add distilled water.

The sealing strip should not be pulled off once the specified electrolyte has been installed in the battery for initial service.

However, in order to maximize battery life and ensure that it will provide the power needed to start the motorcycle you must properly maintain the battery's charge. When used regularly, the charging system in the motorcycle helps keep the battery fully charged. If your motorcycle is only used occasionally or for short periods of time, the battery is more likely to discharge.

Due to their internal composition, batteries continually self discharge. The discharge rate depends on the type of battery and ambient temperature. As temperatures rise, so does the discharge rate. Every 15°C (59°F) doubles the rate.

Electrical accessories, such as digital clocks and computer memory, also draw current from the battery even when the key is switched off. Combine such "key-off" draws with hot temperature, and a battery can go from fully charged to completely discharged in a matter of days.

Self-discharge		
Temperature	Approx. Number of Days From 100% Charged to 100% discharged	
	Lead -Antimony	Lead -Calcium
	Battery	Battery
40°C (104°F)	100 Days	300 Days
25°C (77°F)	200 Days	600 Days
0°C (32°F)	550 Days	950 Days

Current Drain		
Dis-charging Ampere	Days from 100% charged to 50% Discharged	Days from 100% charged to 100% Discharged
7 mA	60 Days	119 Days
10 mA	42 Days	83 Days
15 mA	28 Days	56 Days
20 mA	21 Days	42 Days
30 mA	14 Days	28 Days

In extremely cold weather the fluid in an inadequately charged battery can easily freeze, which can crack the case and buckle the plates. A fully charged battery can withstand sub-freezing temperatures with no damage.

Battery Sulfation

A common cause of battery failure is sulfation.

122 MAINTENANCE AND ADJUSTMENT

Sulfation occurs when the battery is left in a discharged condition for an extended time. Sulfate is a normal by product of the chemical reactions within a battery. But when continuous discharge allows the sulfate to crystallize in the cells, the battery plates become permanently damaged and will not hold a charge. Battery failure due to sulfation is not warrantable.

Battery Maintenance

It is the owner's responsibility to keep the battery fully charged. Failure to do so can lead to battery failure and leave you stranded.

If you are riding your vehicle infrequently, inspect the battery voltage weekly using a voltmeter. If it drops below 12.8 volts, the battery should be

charged using an appropriate charger (check with your Kawasaki dealer). If you will not be using the motorcycle for longer than two weeks, the battery should be charged using an appropriate charger. Do not use an automotive-type quick charger that may overcharge the battery and damage it.

NOTE

- *Leaving the battery connected causes the electrical components (clock etc) to make the battery discharged, resulting the over discharge of the battery. In this case, the repair or replacement of the battery is not included in the warranty. If you do not drive for four weeks or more, disconnect the battery from the vehicle.*

Kawasaki-recommended chargers are:

Battery Mate 150-9

OptiMate 4

Yuasa MB-2040/2060

Christie C10122S

If the above chargers are not available, use equivalent one.

For more details, ask your Kawasaki dealer.

Battery Charging

- Remove the battery from the motorcycle (see Battery Removal).
- Attach the leads from the charger and charge the battery at a rate (amperage × hours) that is indicated on the battery. If it is not possible to read the rate, charge the battery at an amperage that is about 1/10th of the battery capacity.

- The charger will keep the battery fully charged until you are ready to re-install the battery in the motorcycle (see Battery Installation).

NOTICE

Never remove the sealing strip, or the battery can be damaged. Do not install a conventional battery in this motorcycle, or the electrical system cannot work properly.

Make	Yuasa Battery
Type	YTX12-BS

NOTE

- *If you charge the sealed battery, never fail to observe the instructions shown in the label on the battery.*

124 MAINTENANCE AND ADJUSTMENT

Battery Removal

- Make sure the ignition switch is turned to OFF.
- Remove the seat and tool kit.
- Remove the screw and move the ECU aside without disconnecting the connectors from the ECU.

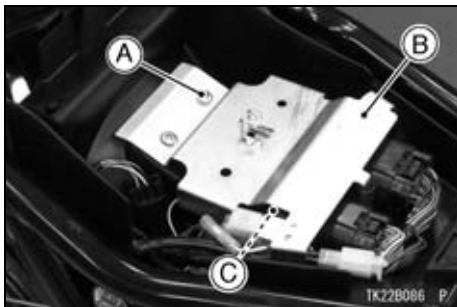

- A. Screw
- B. Bracket
- C. ECU

- Disconnect the cables from the battery, first from the (-) terminal and then the (+) terminal.

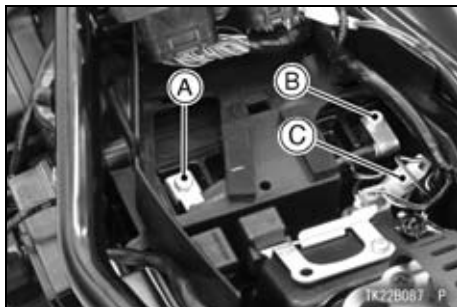

- A. (+) Terminal
- B. (-) Terminal
- C. Ground Connector

- Disconnect the ground connector of the battery (–) cables.
- Remove the left side cover (see Air Cleaner section).
- Remove the battery holder bolts.

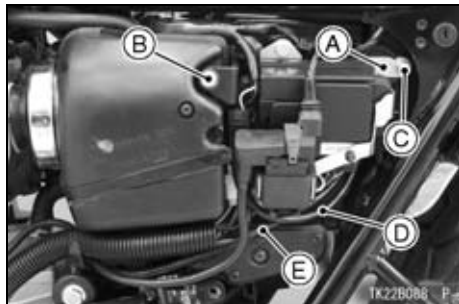

- A. Battery Holder
- B. Battery Holder Bolt (Shorter) and Washer
- C. Battery Holder Bolt (Longer)
- D. Battery (+) Cable
- E. Battery (–) Cable

- Pull out the battery holder and battery (+) and (–) cables.

NOTICE

Do not give the battery holder a strong pull, or the leads may become disconnected.

- Remove the battery from the battery holder.



- A. Battery

126 MAINTENANCE AND ADJUSTMENT

Battery Installation

- Clean the battery using a solution of baking soda and water. Be sure that the cable connections are clean.
- Place the battery in the battery case with the pad under the battery.
- Connect the red capped cable to the (+) terminal from the rear, and then connect the black cable to the (-) terminal.

NOTE

- *Install the battery in the reverse order of the Battery Removal.*

NOTICE

Installing the (-) cable to the (+) terminal of the battery or the (+) cable to the (-) terminal of the battery can seriously damage the electrical system.

- Put a light coat of grease on the terminals to prevent corrosion.
- Cover the (+) terminal with its protective cap.
- Reinstall the parts removed .

Headlight Beam

Horizontal Adjustment

The headlight beam is adjustable horizontally. If not properly adjusted horizontally, the beam will point to one side rather than straight ahead.

- Turn the horizontal adjuster clockwise or counterclockwise until the beam points straight ahead.

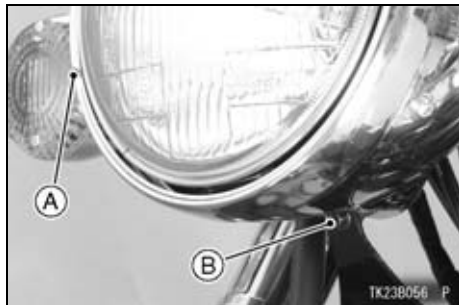

A. Horizontal Adjuster
B. Vertical Adjuster

Vertical Adjustment

The headlight beam is adjustable vertically. If adjusted too low, neither low nor high beam will illuminate the road far enough ahead. If adjusted too high, the high beam will fail to illuminate the road close ahead, and the low beam will blind oncoming drivers.

- Turn the vertical adjuster clockwise or counterclockwise to adjust its vertical angle.

NOTE

- *On high beam, the brightest point should be slightly below horizontal with the motorcycle on its wheels and the rider seated. Adjust the headlight to the proper angle according to local regulations.*



Fuses

Fuses are arranged in the junction box located inside the left side cover. The main fuse is mounted on the starter relay located inside the left side cover. If a fuse fails during operation, inspect the electrical system to determine the cause, and then replace it with a new fuse of proper amperage.

- Remove the seat.
- Remove the left side cover (see Air Cleaner section).

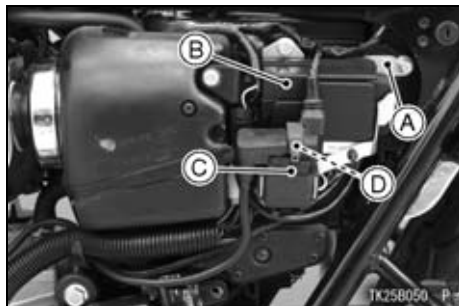

- A. Battery Holder
- B. Junction Box
- C. Starter Relay
- D. Main Fuse

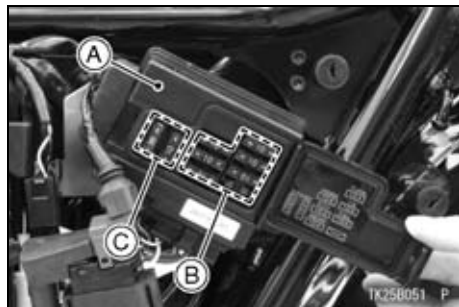

- A. Junction Box
- B. Fuses
- C. Spare Fuses

⚠ WARNING

Substituting fuses can cause wiring to overheat, catch fire and/or fail. Do not use any substitute for the standard fuse. Replace the blown fuse with a new one of the correct capacity, as specified on the junction box and main fuse.

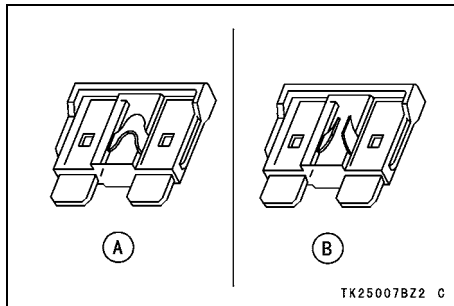

A. Normal
B. Failed

General Lubrication

Lubricate the points shown below, with either motor oil or regular grease, in accordance with the Periodic Maintenance Chart or whenever the vehicle has been operated under wet or rainy conditions.

Before lubricating each part, clean off any rusty spots with rust remover and wipe off any grease, oil, dirt, or grime.

NOTE

- *A few drops of oil are effective to keep bolts and nuts from rusting and sticking. This makes removal easier. Badly rusted nuts, bolts, etc., should be replaced with new ones.*

Apply motor oil to the following pivots -

- Side Stand
- Clutch Lever
- Front Brake Lever
- Rear Brake Pedal

Lubricate the following cables with a pressure cable luber -

- (K) Clutch Inner Cable
- (K) Throttle Inner Cables

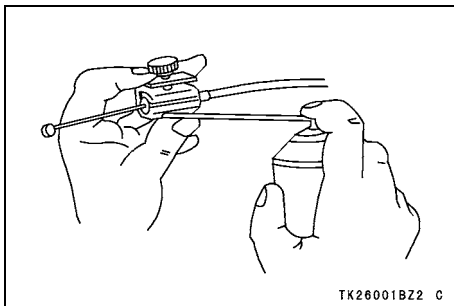

Apply grease to the following points -

- **(K)** Clutch Inner Cable Upper End
- **(K)** Throttle Inner Cable Upper Ends

(K): Should be serviced by an authorized Kawasaki dealer.

NOTE

- *After connecting the cables, adjust them.*

Cleaning Your Motorcycle

General Precautions

Frequent and proper care of your Kawasaki motorcycle will enhance its appearance, optimize overall performance, and extend its useful life. Covering your motorcycle with a high quality, breathable motorcycle cover will help protect its finish from harmful UV rays, pollutants, and reduce the amount of dust reaching its surfaces.

 **WARNING**

Build-up of debris or flammable material in and around the vehicle chassis, engine, and exhaust can cause mechanical problems and increase the risk of fire.

When operating the vehicle in conditions that allow debris or flammable material to collect in and around the vehicle, inspect the engine, electrical component and exhaust areas frequently. If debris or flammable materials have collected, park the vehicle outside and stop the engine. Allow the engine to cool, then remove any collected debris. Do not park or store the vehicle in an enclosed space prior to inspecting for build-up of debris or flammable materials.

- Be sure the engine and exhaust are cool before washing.
- Avoid applying degreaser to seals, brake pads, and tires.
- Always use non-abrasive wax and cleaner/polisher.
- Avoid all harsh chemicals, solvents, detergents, and household cleaning products such as ammonia-based window cleaners.
- Gasoline and brake fluid will damage the finish of painted and plastic surfaces: wash them off immediately.
- Avoid wire brushes, steel wool, and all other abrasive pads or brushes.
- Use care when washing the side covers and other plastic parts as they can easily be scratched.
- Avoid using pressure washers; water can penetrate seals and electrical components and damage your motorcycle.

134 MAINTENANCE AND ADJUSTMENT

- Avoid spraying water in delicate areas such as in air intakes, throttle body, brake components, electrical components, muffler outlets, and fuel tank openings.

Washing Your Motorcycle

- Rinse your bike with cold water from a garden hose to remove any loose dirt.
- Mix a mild neutral detergent (designed for motorcycles or automobiles) and water in bucket. Use a soft cloth or sponge to wash your motorcycle. If needed, use a mild degreaser to remove any oil or grease build up.
- After washing, rinse your motorcycle thoroughly with clean water to remove any residue (residue from the

detergent can damage parts of your motorcycle).

- Use a soft cloth to dry your motorcycle. As you dry, inspect your motorcycle for chips and scratches. Do not let the water air dry as this can damage the painted surfaces.
- Start the engine and let it idle for several minutes. The heat from the engine will help dry moist areas.
- Carefully ride your motorcycle at a slow speed and apply the brakes several times. This helps dry the brakes and restores them to normal operating performance.
- Lubricate the drive chain to prevent rusting.

NOTE

- *After riding in an area where the roads are salted or near the ocean, immediately wash your motorcycle with cold water. Do not use warm water as it accelerates the chemical reaction of the salt. After drying, apply a corrosion protection spray on all metal and chrome surfaces to prevent corrosion.*
- *Condensation may form on the inside of the headlight lens after riding in the rain or washing the motorcycle. To remove the moisture, start the engine and turn on the headlight. Gradually the condensation on the inside of the lens will clear off.*

Semi-gloss Finish

To clean the semi-gloss finish;

- When washing the motorcycle, always use a mild neutral detergent and water.
- The semi-gloss finish effect may be lost when the finish is excessively rubbed.
- If any doubt, consult an authorized Kawasaki dealer.

Painted Surfaces

After washing your motorcycle, coat painted surfaces, both metal and plastic, with a commercially available motorcycle/automotive wax. Wax should be applied once every three months or as conditions require. Avoid surfaces with “satin” or “flat” finishes. Always use non-abrasive products and apply them according to the instructions on the container.

Plastic Parts

After washing use a soft cloth to gently dry plastic parts. When dry, treat the headlight lens and other non-painted plastic parts with an approved plastic cleaner/polisher product.

NOTICE

Plastic parts may deteriorate and break if they come in contact with chemical substances or household cleaning products such as gasoline, brake fluid, window cleaners, thread-locking agents, or other harsh chemicals. If a plastic part comes in contact with any harsh chemical substance, wash it off immediately with water and a mild neutral detergent, and then inspect for damage. Avoid using abrasive pads or brushes to clean plastic parts, as they will damage the part's finish.

Chrome and Aluminum

Chrome and uncoated aluminum parts can be treated with a chrome/aluminum polish. Coated aluminum should be washed with a mild neutral detergent and finished with a spray polish. Aluminum wheels, both painted and unpainted can be cleaned with special non-acid based wheel spray cleaners.

Leather, Vinyl, and Rubber

If your motorcycle has leather accessories, special care must be taken. Use a leather cleaner/treatment to clean and care for leather accessories. Washing leather parts with detergent and water will damage them, shortening their life.

Vinyl parts should be washed with the rest of the motorcycle, then treated with a vinyl treatment.

The sidewalls of tires and other rubber components should be treated with a rubber protectant to help prolong their useful life.

**WARNING**

Rubber protectants can be slippery and, if used on the tread area, cause loss of traction resulting in accident causing injury or death. Do not apply rubber protectant to any tread area.

STORAGE

Preparation for Storage:

- Clean the entire vehicle thoroughly.
- Run the engine for about five minutes to warm the oil, shut it off, and drain the engine oil.

 **WARNING**

Engine oil is a toxic substance. Dispose of used oil properly. Contact your local authorities for approved disposal methods or possible recycling.

- Put in fresh engine oil.
- Empty the fuel from the fuel tank by the pump or siphon.

 **WARNING**

Gasoline is extremely flammable and can be explosive under certain conditions, creating the potential for serious burns. Turn the ignition switch to “OFF”. Do not smoke. Make sure the area is well-ventilated and free from any source of flame or sparks; this includes any appliance with a pilot light. Gasoline is a toxic substance. Dispose of gasoline properly. Contact your local authorities for approved disposal methods.

- Empty the fuel system by running the engine at idle speed until the engine stalls. (If left in for a long time, the fuel will break down and could clog the fuel system.)
- Reduce tire pressure by about 20%.
- Set the motorcycle on a box or stand so that both wheels are raised off the ground. (If this cannot be done, put boards under the front and rear wheels to keep dampness away from the tire rubber.)
- Spray oil on all unpainted metal surfaces to prevent rusting. Avoid getting oil on rubber parts or in the brakes.
- Lubricate the drive chain and all the cables.
- Remove the battery, and store it where it will not be exposed to direct sunlight, moisture, or freezing temperatures. During storage it should be given a slow charge (one ampere or less) about once a month. Keep the battery well charged especially during cold weather.
- Tie plastic bags over the mufflers to prevent moisture from entering.

140 STORAGE

- Put a cover over the motorcycle to keep dust and dirt from collecting on it.

Preparation after Storage:

- Remove the plastic bags from the mufflers.
- Install the battery in the motorcycle and charge the battery if necessary.
- Fill the fuel tank with fuel.
- Check all the points listed in the Daily Checks section.
- Lubricate the pivots, bolts, and nuts.

ENVIRONMENTAL PROTECTION

To help preserve the environment, properly discard used batteries, tires, oils and fluids, or other vehicle components that you might dispose of in the future. Consult your authorized Kawasaki dealer or local environmental waste agency for their proper disposal procedure. This also applies to disposal of the entire vehicle at the end of its life.

OWNER SATISFACTION

Your satisfaction is important to your authorized Kawasaki dealer and to Kawasaki Motors Pty., Ltd. If you have a problem concerning warranty or service, please take the following action:

Contact the owner and/or service manager of your authorized Kawasaki dealer. Fully explain your problem and ask for assistance in resolving the situation. The OWNER of the dealership is an independent business person and is concerned with your satisfaction and your future business. For this reason the owner is in the best position to assist you. Also, all warranty and service matters are handled and resolved through the authorized Kawasaki dealer network.

If you are unsatisfied after working with your Kawasaki dealer and feel you still require further assistance, WRITE to the address below. Please be certain to provide the model, product identification number, mileage or hours of use, accessories, dates that events occurred and what action has been taken by both you and your dealer. Include the name and address of the dealership. To assist us in resolving your inquiry, please include copies of related receipts and any other pertinent information including the names of the dealership personnel with whom you have been working in the resolution of your problem.

Upon receipt of your WRITTEN correspondence we will contact the dealership and work with them in resolving your problem.

In order to provide a permanent record, all warranty and service resolutions take place only through WRITTEN correspondence.

Please send your correspondence to:

Customer Relations:

Technical Services Department
KAWASAKI MOTORS Pty., Ltd.
LOCKED BAG 802,
ERMINGTON. NSW. 1700.
A.C.N.: 002 840 315

LOCATION OF LABELS

All warning labels which are on your vehicle are repeated here. Read labels on your vehicle and understand them thoroughly. They contain information which is important for your safety and the safety of anyone else who may operate your vehicle. Therefore, it is very important that all warning labels be on your vehicle in the locations shown. If any label is missing, damaged, or worn, get a replacement from your Kawasaki dealer and install it in the correct position.

NOTE

- *The sample warning labels in this section have part numbers to help*

you and your dealer obtain the correct replacement.

- *Refer to the actual vehicle label for model specific data grayed out in the illustration.*

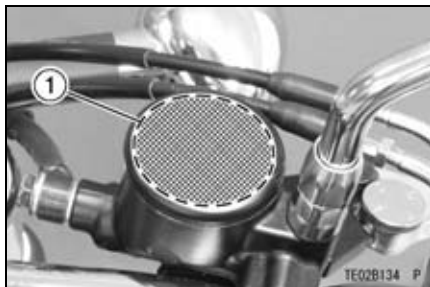

1. Brake Fluid (Front)

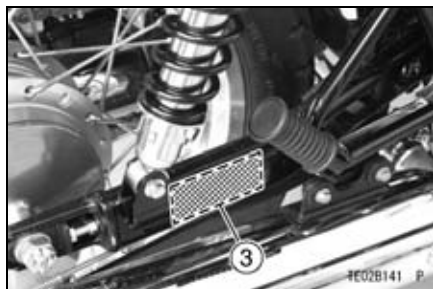
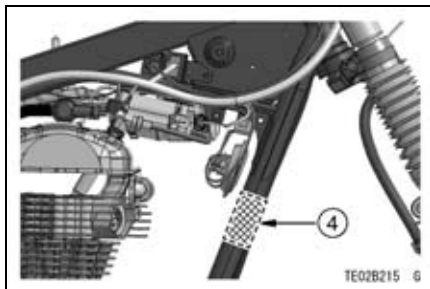

- 2. Important Drive Chain Information
- 3. Tire and Load Data
- 4. Stationary Noise Test Information

146 LOCATION OF LABELS

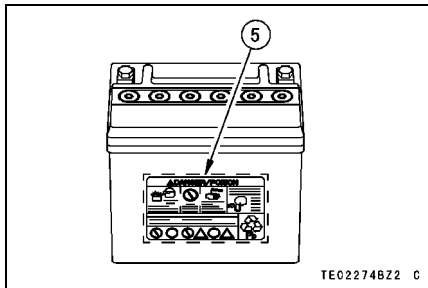

5. Battery Poison/Danger

(1)

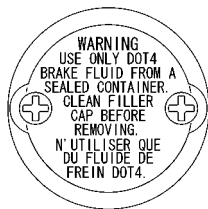

TE03029E S

(2) only on Australia model

IMPORTANT DRIVE CHAIN INFORMATION

To prevent an accident and/or damage to the motorcycle, the drive chain must be properly maintained. It should be lubricated every 600km(400mi) and adjusted as often as necessary to keep chain slack at about 25~35mm(1.0~1.4in) measured midway between sprockets on the lower chain run with the motorcycle on the side stand. The standard chain is an Enuma EK520MVXL with estimated service life of 15000~45000km(9400~28000mi), depending on the severity of use and the frequency of lubrication and adjustment. For safety, replace the chain with only the standard chain any time it wears to over 319mm(12.56in), measured over a 20-link portion pulled straight with 98N(10kgf, 20lbf) of tension. See the Owner's Manual for chain information.

INFORMATIONS IMPORTANTES RELATIVES A LA CHAÎNE DE TRANSMISSION

Pour éviter un accident et/ou endommager la moto, la chaîne doit être correctement entretenue. Elle doit être lubrifiée tous les 600kms et ajustée aussi souvent que cela est nécessaire pour conserver une flèche de 25 à 35mm mesurée entre les deux pignons sur le brin inférieur quand la moto repose sur la béquille latérale. La chaîne d'origine est de marque Enuma EK520MVXL et possède une durée de vie d'environ 15000 à 45000kms selon l'usage, la fréquence de graissage et le réglage. Par sécurité remplacer la chaîne usée par une chaîne d'origine uniquement, dès que la mesure d'usure atteint 319mm. L'usure se vérifie en attachant un poids de 10kgs avant de mesurer la longueur de 20 maillons. Voir également le manuel d'utilisateur pour les informations sur la chaîne.

56033-0356

(2) only on Southeast Asia model**IMPORTANT DRIVE CHAIN INFORMATION**

To prevent an accident and/or damage to the motorcycle, the drive chain must be properly maintained. It should be lubricated every 600km(400mi) and adjusted as often as necessary to keep chain slack at about 25~35mm(1.0~1.4in) measured midway between sprockets on the lower chain run with the motorcycle on the side stand. The standard chain is an Enuma EK520MVXL1 with estimated service life of 15000~45000km(9400~28000mi), depending on the severity of use and the frequency of lubrication and adjustment. For safety, replace the chain with only the standard chain any time it wears to over 318mm(12.56in), measured over a 20-link portion pulled straight with 98N(10kgf, 20lbf) of tension. See the Owner's Manual for chain information.

56033-0357

TE03539CN8 C

150 LOCATION OF LABELS

(3) only on Australia model

TIRE AND LOAD DATA

The stability and handling characteristics of this motorcycle could become unsafe by the use of improper tire inflation pressures, overworn tires, unsuitable replacement tires, or overloading. When tire tread wears down to the limit, replace the tire with only the standard tire. Maintain the inflation pressure specified.

	Air Pressure(Cold)		Size & Make Type		Minimum Tread Depth	
Front	Up to 183kg Load (403lbs)	200 kPa (2.00kg/cm ² , 28psi)	DUNLOP 100/90-19M/C 57H TT100GP G		1 mm(0.04 in)	
Rear	Up to 97.5kg Load (215lbs)	225 kPa (2.25kg/cm ² , 32psi)	DUNLOP 130/80-18M/C 66H TT100GP		Up to 130 km/h(80MPH)	2 mm(0.08 in)
	97.5-183 kg Load (215-403lbs)	250 kPa (2.50kg/cm ² , 36psi)			Over 130 km/h(80MPH)	3 mm(0.12 in)

DONNEES POUR PNEUS ET CHARGE

La stabilité et les caractéristiques de tenue de route de cette motocyclette pourraient devenir dangereuses si l'on utilise des pressions de gonflement incorrectes, des pneus trop usés, des pneus de rechange inaptes ou par le surchargement. Maintenir la pression de gonflement spécifiée.

	Pression d'air à froid		Grosseur fabricant & Type(pneu sans chambre)		Profondeur minimum de la bande de roulement	
Avant	Jusqu'à 183 kg de charge	200 kPa (2.00kg/cm ² , 28psi)	DUNLOP 100/90-19M/C 57H TT100GP G		1 mm(0.04 in)	
Arrière	Jusqu'à 97.5 kg de charge	225 kPa (2.25kg/cm ² , 32psi)	DUNLOP 130/80-18M/C 66H TT100GP		Au dessous 130 km/h(80MPH)	2 mm(0.08 in)
	97.5-183 kg de charge	250 kPa (2.50kg/cm ² , 36psi)			Au dessus 130 km/h(80MPH)	3 mm(0.12 in)

56053-0723

TE03598D S

(3) only on Southeast Asia model

TIRE AND LOAD DATA			
The stock tire and load information is based on a maximum of 6000 pounds (2700 kg) by the use of proper tire inflation pressures, maximum load, and proper use of correct tire on overload use, and tire tread wear's down to 1/8" (3.2 mm) add the tire with only the standard tire. Maximum tire inflation pressure should be:			
	Air Pressure (PSI)	Size & Ply	Minimum Tread Depth
Front	Up to 28 PSI (1.93 bar) 28 PSI (1.93 bar)	175R14 185R14 195R14	1/8" (3.2 mm)
Rear	Up to 30 PSI (2.07 bar) 30 PSI (2.07 bar)	185R14 195R14 205R14	1/8" (3.2 mm)

56053-0804

TE03088E S





152 LOCATION OF LABELS

(4)

STATIONARY NOISE TEST INFORMATION	
TESTED:	
	dB(A) AT min-1
SILENCING SYSTEM:	
KAWASAKI HEAVY INDUSTRIES, LTD.	
IDENTIFICATION:	

TE03927DN9 C

(5)

▲ DANGER/POISON			S-23
 SHIELD EYES	 NO SPARKS NO FLAMES NO SMOKING	 SULFURIC ACID CAN CAUSE BLINDNESS OR SEVERE BURNS	FLUSH EYES IMMEDIATELY WITH WATER GET MEDICAL HELP FAST 
EXPLOSIVE GASES CAN CAUSE BLINDNESS OR INJURY			
KEEP OUT OF REACH OF CHILDREN			
IN U.S.A., SERVICED BY :		YUASA BATTERY, INC. READING, PA. 19605	
			
 LEAD RECYCLE Pb			 RECYCLE Pb

TE03648D S

EJ800AF



Kawasaki Heavy Industries, Ltd. Motorcycle & Engine Company

Printed in Japan

GB