



⚠ Read this manual carefully before operating this vehicle.

OWNER'S MANUAL



**Star**

**XV250Z**

**1BE-28199-20**

 **Read this manual carefully before operating this vehicle. This manual should stay with this vehicle if it is sold.**

Welcome to the Yamaha world of motorcycling!

As the owner of the XV250Z, you are benefiting from Yamaha's vast experience and newest technology regarding the design and manufacture of high-quality products, which have earned Yamaha a reputation for dependability.

Please take the time to read this manual thoroughly, so as to enjoy all advantages of your XV250Z. The Owner's Manual does not only instruct you in how to operate, inspect and maintain your motorcycle, but also in how to safeguard yourself and others from trouble and injury.

In addition, the many tips given in this manual will help keep your motorcycle in the best possible condition. If you have any further questions, do not hesitate to contact your Yamaha dealer.

The Yamaha team wishes you many safe and pleasant rides. So, remember to put safety first!

Yamaha continually seeks advancements in product design and quality. Therefore, while this manual contains the most current product information available at the time of printing, there may be minor discrepancies between your motorcycle and this manual. If there is any question concerning this manual, please consult a Yamaha dealer.



---

**Please read this manual carefully and completely before operating this motorcycle.**

---



# IMPORTANT MANUAL INFORMATION

---

---

EAU10132

Particularly important information is distinguished in this manual by the following notations:

	<b>This is the safety alert symbol. It is used to alert you to potential personal injury hazards. Obey all safety messages that follow this symbol to avoid possible injury or death.</b>
	<b>A WARNING indicates a hazardous situation which, if not avoided, could result in death or serious injury.</b>
	<b>A NOTICE indicates special precautions that must be taken to avoid damage to the vehicle or other property.</b>
<b>TIP</b>	<b>A TIP provides key information to make procedures easier or clearer.</b>

# IMPORTANT MANUAL INFORMATION

---

---

EAU10200

**XV250Z  
OWNER'S MANUAL  
©2009 by Yamaha Motor Co., Ltd.  
1st edition, April 2009  
All rights reserved.  
Any reprinting or unauthorized use  
without the written permission of  
Yamaha Motor Co., Ltd.  
is expressly prohibited.  
Printed in Japan.**

# TABLE OF CONTENTS

---

---

<b>LOCATION OF IMPORTANT LABELS</b> .....	1-1	<b>FOR YOUR SAFETY – PRE-OPERATION CHECKS</b> .....	5-1	Valve clearance .....	7-14
<b>SAFETY INFORMATION</b> .....	2-1	<b>OPERATION AND IMPORTANT RIDING POINTS</b> .....	6-1	Tires .....	7-15
<b>DESCRIPTION</b> .....	3-1	Starting and warming up a cold engine .....	6-1	Spoke wheels .....	7-16
Left view .....	3-1	Starting a warm engine .....	6-2	Adjusting the clutch lever free play .....	7-17
Right view .....	3-2	Shifting .....	6-2	Adjusting the brake lever free play .....	7-18
Controls and instruments.....	3-3	Tips for reducing fuel consumption .....	6-3	Adjusting the brake pedal position and free play .....	7-19
<b>INSTRUMENT AND CONTROL FUNCTIONS</b> .....	4-1	Engine break-in .....	6-3	Adjusting the rear brake light switch .....	7-20
Main switch .....	4-1	Parking .....	6-4	Checking the front brake pads and rear brake shoes .....	7-20
Indicator lights .....	4-1	<b>PERIODIC MAINTENANCE AND ADJUSTMENT</b> .....	7-1	Checking the brake fluid level .....	7-21
Speedometer unit .....	4-2	Owner's tool kit .....	7-1	Changing the brake fluid .....	7-22
Handlebar switches .....	4-2	Periodic maintenance chart for the emission control system .....	7-2	Drive chain slack .....	7-22
Clutch lever .....	4-4	General maintenance and lubrication chart .....	7-3	Cleaning and lubricating the drive chain .....	7-24
Shift pedal .....	4-4	Removing and installing the panel .....	7-7	Checking and lubricating the cables .....	7-24
Brake lever .....	4-4	Checking the spark plugs .....	7-7	Checking and lubricating the throttle grip and cable .....	7-25
Brake pedal .....	4-5	Engine oil and oil filter element .....	7-9	Checking and lubricating the brake and shift pedals .....	7-25
Fuel tank cap .....	4-5	Cleaning the air filter element .....	7-11	Checking and lubricating the brake and clutch levers .....	7-26
Fuel .....	4-6	Adjusting the carburetor .....	7-13	Checking and lubricating the sidestand .....	7-26
Fuel cock .....	4-7	Adjusting the engine idling speed .....	7-13	Lubricating the swingarm pivots .....	7-27
Starter (choke) lever .....	4-8	Checking the throttle cable free play .....	7-14	Checking the front fork .....	7-27
Steering lock .....	4-8				
Rider seat .....	4-9				
Helmet holder .....	4-9				
Adjusting the shock absorber assemblies .....	4-10				
Sidestand .....	4-10				
Ignition circuit cut-off system .....	4-11				

# TABLE OF CONTENTS

---

---

Checking the steering .....	7-28
Checking the wheel bearings .....	7-28
Battery .....	7-28
Replacing the fuses .....	7-30
Replacing the headlight bulb .....	7-31
Replacing the tail/brake light bulb .....	7-32
Replacing a turn signal light bulb .....	7-33
Supporting the motorcycle .....	7-33
Front wheel .....	7-34
Rear wheel .....	7-36
Troubleshooting .....	7-37
Troubleshooting chart .....	7-39

## **MOTORCYCLE CARE AND**

<b>STORAGE</b> .....	8-1
Matte color caution .....	8-1
Care .....	8-1
Storage .....	8-3

## **SPECIFICATIONS** .....

9-1

## **CONSUMER INFORMATION**.....

Identification numbers .....	10-1
Motorcycle noise regulation (for Australia) .....	10-2

# LOCATION OF IMPORTANT LABELS

---

EAU10383

1

Read and understand all of the labels on your vehicle. They contain important information for safe and proper operation of your vehicle. Never remove any labels from your vehicle. If a label becomes difficult to read or comes off, a replacement label is available from your Yamaha dealer.

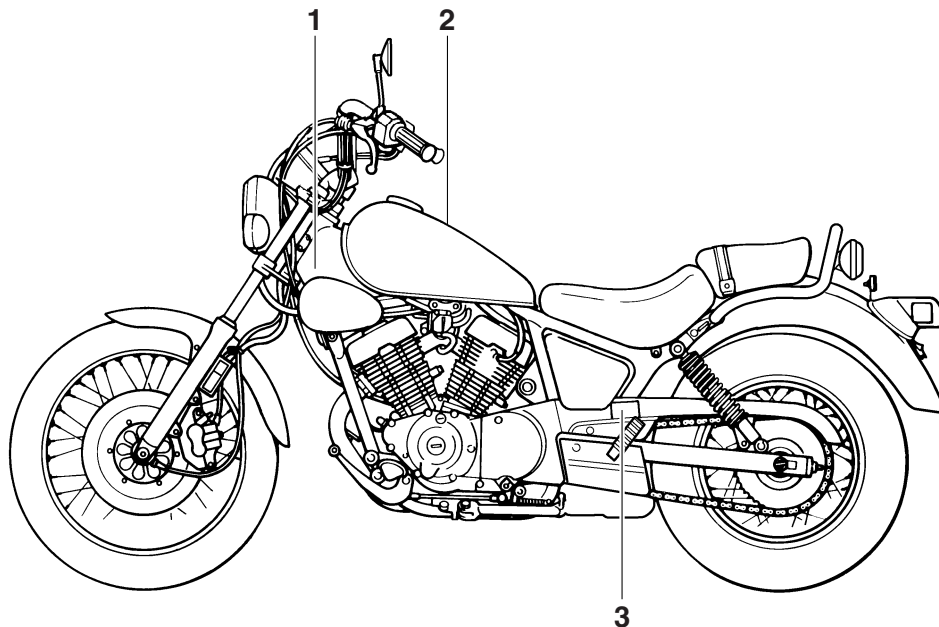



# LOCATION OF IMPORTANT LABELS

1

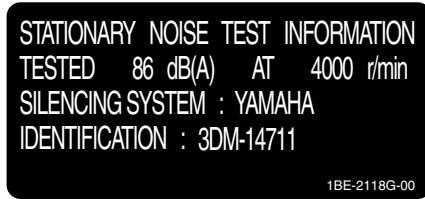

3

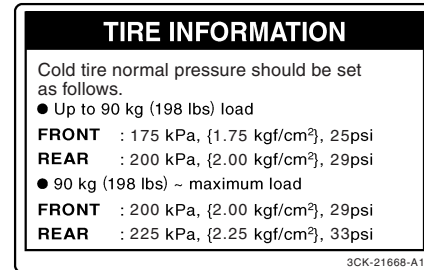

2

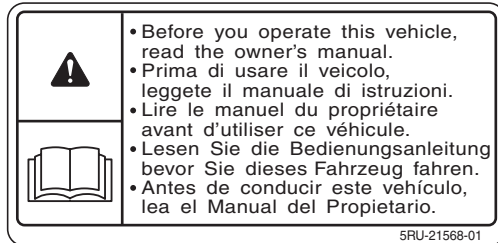

# SAFETY INFORMATION

EAU10283

2

## Be a Responsible Owner

As the vehicle's owner, you are responsible for the safe and proper operation of your motorcycle.

Motorcycles are single-track vehicles. Their safe use and operation are dependent upon the use of proper riding techniques as well as the expertise of the operator. Every operator should know the following requirements before riding this motorcycle.

He or she should:

- Obtain thorough instructions from a competent source on all aspects of motorcycle operation.
- Observe the warnings and maintenance requirements in this Owner's Manual.
- Obtain qualified training in safe and proper riding techniques.
- Obtain professional technical service as indicated in this Owner's Manual and/or when made necessary by mechanical conditions.

## Safe Riding

Perform the pre-operation checks each time you use the vehicle to make sure it is in safe operating condition. Failure to inspect or maintain the vehicle properly increases the possibility of an accident or equipment damage. See page 5-1 for a list of pre-operation checks.

- This motorcycle is designed to carry the operator and a passenger.
- The failure of motorists to detect and recognize motorcycles in traffic is the predominating cause of automobile/motorcycle accidents. Many accidents have been caused by an automobile driver who did not see the motorcycle. Making yourself conspicuous appears to be very effective in reducing the chance of this type of accident.

### Therefore:

- Wear a brightly colored jacket.
- Use extra caution when you are approaching and passing through intersections, since intersections are the most likely places for motorcycle accidents to occur.

- Ride where other motorists can see you. Avoid riding in another motorist's blind spot.
- Many accidents involve inexperienced operators. In fact, many operators who have been involved in accidents do not even have a current motorcycle license.
- Make sure that you are qualified and that you only lend your motorcycle to other qualified operators.
- Know your skills and limits. Staying within your limits may help you to avoid an accident.
- We recommend that you practice riding your motorcycle where there is no traffic until you have become thoroughly familiar with the motorcycle and all of its controls.
- Many accidents have been caused by error of the motorcycle operator. A typical error made by the operator is veering wide on a turn

due to excessive speed or undercornering (insufficient lean angle for the speed).

- Always obey the speed limit and never travel faster than warranted by road and traffic conditions.
- Always signal before turning or changing lanes. Make sure that other motorists can see you.
- The posture of the operator and passenger is important for proper control.
  - The operator should keep both hands on the handlebar and both feet on the operator footrests during operation to maintain control of the motorcycle.
  - The passenger should always hold onto the operator, the seat strap or grab bar, if equipped, with both hands and keep both feet on the passenger footrests. Never carry a passenger unless he or she can firmly place both feet on the passenger footrests.
- Never ride under the influence of alcohol or other drugs.

- This motorcycle is designed for on-road use only. It is not suitable for off-road use.

### **Protective apparel**

The majority of fatalities from motorcycle accidents are the result of head injuries. The use of a safety helmet is the single most critical factor in the prevention or reduction of head injuries.

- Always wear an approved helmet.
- Wear a face shield or goggles. Wind in your unprotected eyes could contribute to an impairment of vision that could delay seeing a hazard.
- The use of a jacket, heavy boots, trousers, gloves, etc., is effective in preventing or reducing abrasions or lacerations.
- Never wear loose-fitting clothes, otherwise they could catch on the control levers, footrests, or wheels and cause injury or an accident.
- Always wear protective clothing that covers your legs, ankles, and feet. The engine or exhaust system become very hot during or after operation and can cause burns.

- A passenger should also observe the above precautions.

### **Avoid Carbon Monoxide Poisoning**

All engine exhaust contains carbon monoxide, a deadly gas. Breathing carbon monoxide can cause headaches, dizziness, drowsiness, nausea, confusion, and eventually death.

Carbon Monoxide is a colorless, odorless, tasteless gas which may be present even if you do not see or smell any engine exhaust. Deadly levels of carbon monoxide can collect rapidly and you can quickly be overcome and unable to save yourself. Also, deadly levels of carbon monoxide can linger for hours or days in enclosed or poorly ventilated areas. If you experience any symptoms of carbon monoxide poisoning, leave the area immediately, get fresh air, and **SEEK MEDICAL TREATMENT**.

- Do not run engine indoors. Even if you try to ventilate engine exhaust with fans or open windows and doors, carbon monoxide can rapidly reach dangerous levels.

## SAFETY INFORMATION

- Do not run engine in poorly ventilated or partially enclosed areas such as barns, garages, or carports.
- Do not run engine outdoors where engine exhaust can be drawn into a building through openings such as windows and doors.

### Loading

Adding accessories or cargo to your motorcycle can adversely affect stability and handling if the weight distribution of the motorcycle is changed. To avoid the possibility of an accident, use extreme caution when adding cargo or accessories to your motorcycle. Use extra care when riding a motorcycle that has added cargo or accessories. Here, along with the information about accessories below, are some general guidelines to follow if loading cargo to your motorcycle:

The total weight of the operator, passenger, accessories and cargo must not exceed the maximum load limit.

**Operation of an overloaded vehicle could cause an accident.**

**Maximum load:**  
196 kg (432 lb)

When loading within this weight limit, keep the following in mind:

- Cargo and accessory weight should be kept as low and close to the motorcycle as possible. Securely pack your heaviest items as close to the center of the vehicle as possible and make sure to distribute the weight as evenly as possible on both sides of the motorcycle to minimize imbalance or instability.
- Shifting weights can create a sudden imbalance. Make sure that accessories and cargo are securely attached to the motorcycle before riding. Check accessory mounts and cargo restraints frequently.
  - Properly adjust the suspension for your load (suspension-adjustable models only), and check the condition and pressure of your tires.
  - Never attach any large or heavy items to the handlebar, front fork, or front fender. These

items, including such cargo as sleeping bags, duffel bags, or tents, can create unstable handling or a slow steering response.

- **This vehicle is not designed to pull a trailer or to be attached to a sidecar.**

### Genuine Yamaha Accessories

Choosing accessories for your vehicle is an important decision. Genuine Yamaha accessories, which are available only from a Yamaha dealer, have been designed, tested, and approved by Yamaha for use on your vehicle.

Many companies with no connection to Yamaha manufacture parts and accessories or offer other modifications for Yamaha vehicles. Yamaha is not in a position to test the products that these aftermarket companies produce. Therefore, Yamaha can neither endorse nor recommend the use of accessories not sold by Yamaha or modifications not specifically recommended by Yamaha, even if sold and installed by a Yamaha dealer.

## **Aftermarket Parts, Accessories, and Modifications**

While you may find aftermarket products similar in design and quality to genuine Yamaha accessories, recognize that some aftermarket accessories or modifications are not suitable because of potential safety hazards to you or others. Installing aftermarket products or having other modifications performed to your vehicle that change any of the vehicle's design or operation characteristics can put you and others at greater risk of serious injury or death. You are responsible for injuries related to changes in the vehicle.

Keep the following guidelines in mind, as well as those provided under "Loading" when mounting accessories.

- Never install accessories or carry cargo that would impair the performance of your motorcycle. Carefully inspect the accessory before using it to make sure that it does not in any way reduce ground clearance or cornering clearance,

limit suspension travel, steering travel or control operation, or obscure lights or reflectors.

- Accessories fitted to the handlebar or the front fork area can create instability due to improper weight distribution or aerodynamic changes. If accessories are added to the handlebar or front fork area, they must be as lightweight as possible and should be kept to a minimum.
- Bulky or large accessories may seriously affect the stability of the motorcycle due to aerodynamic effects. Wind may attempt to lift the motorcycle, or the motorcycle may become unstable in cross winds. These accessories may also cause instability when passing or being passed by large vehicles.
- Certain accessories can displace the operator from his or her normal riding position. This improper position limits the freedom of movement of the opera-

tor and may limit control ability, therefore, such accessories are not recommended.

- Use caution when adding electrical accessories. If electrical accessories exceed the capacity of the motorcycle's electrical system, an electric failure could result, which could cause a dangerous loss of lights or engine power.

## **Aftermarket Tires and Rims**

The tires and rims that came with your motorcycle were designed to match the performance capabilities and to provide the best combination of handling, braking, and comfort. Other tires, rims, sizes, and combinations may not be appropriate. Refer to page 7-15 for tire specifications and more information on replacing your tires.

# DESCRIPTION

EAU10410

## Left view

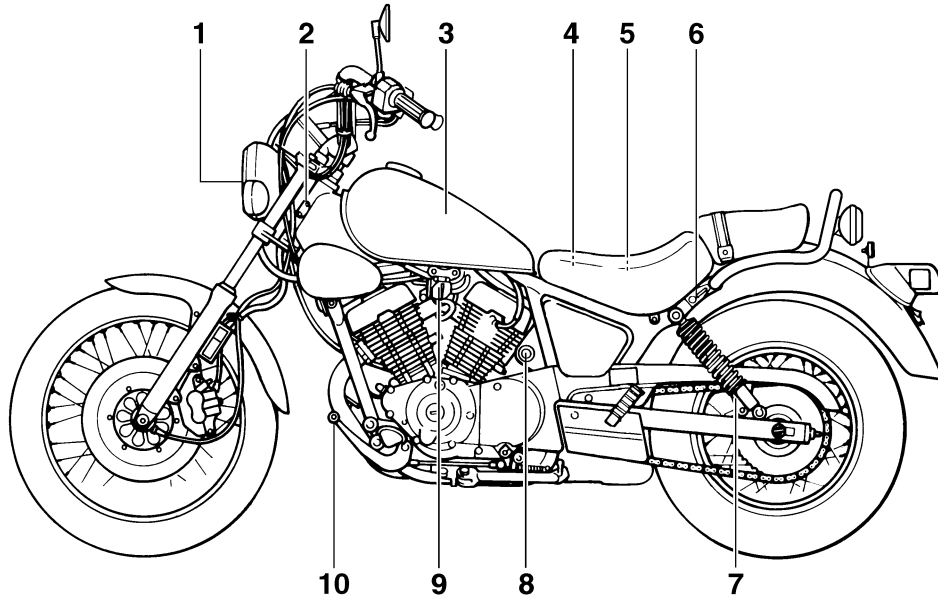

1. Headlight (page 7-31)
2. Steering lock (page 4-8)
3. Fuel tank (page 4-5)
4. Battery (page 7-28)
5. Fuses (page 7-30)
6. Helmet holder (page 4-9)
7. Shock absorber assembly spring preload adjusting ring (page 4-10)
8. Main switch (page 4-1)

9. Fuel cock (page 4-7)
10. Shift pedal (page 4-4)

## Right view

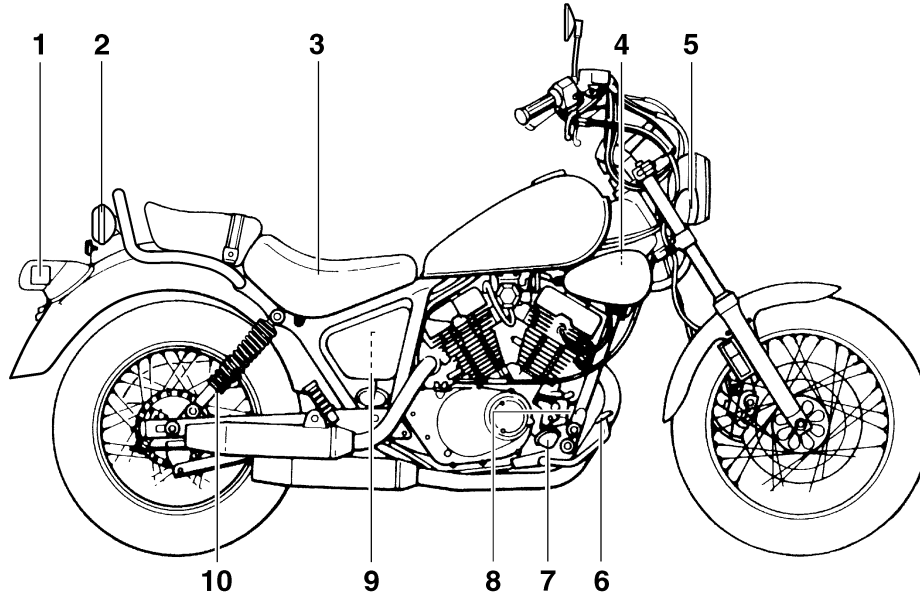

1. Tail/brake light (page 7-32)
2. Rear turn signal light (page 7-33)
3. Rider seat (page 4-9)
4. Air filter element (page 7-11)
5. Front turn signal light (page 7-33)
6. Brake pedal (page 4-5)
7. Footrest
8. Rear brake light switch (page 7-20)

9. Owner's tool kit (page 7-1)
10. Shock absorber assembly spring preload adjusting ring (page 4-10)

# DESCRIPTION

---

EAU10430

## Controls and instruments

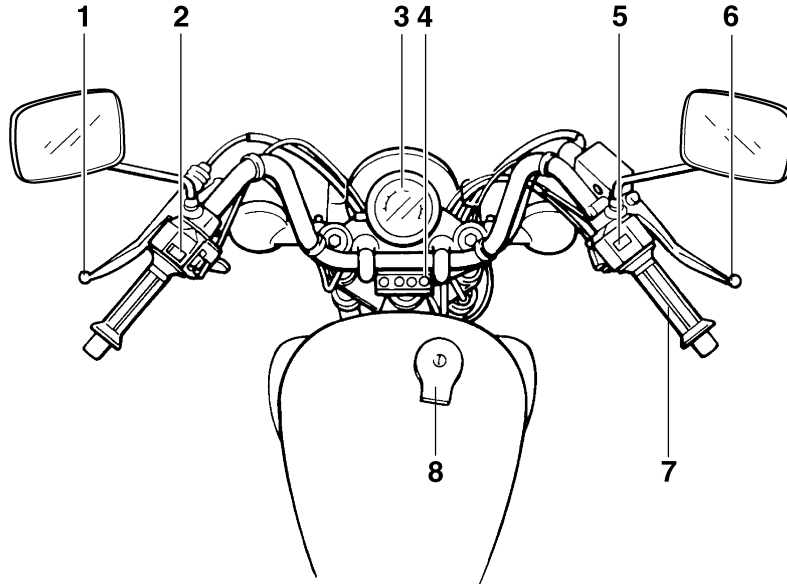

3

1. Clutch lever (page 4-4)
2. Left handlebar switches (page 4-2)
3. Speedometer unit (page 4-2)
4. Indicator lights (page 4-1)
5. Right handlebar switches (page 4-2)
6. Brake lever (page 4-4)
7. Throttle grip (page 7-14)
8. Fuel tank cap (page 4-5)



# INSTRUMENT AND CONTROL FUNCTIONS

## Main switch

EAU10450

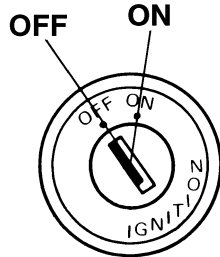

The main switch controls the ignition and lighting systems. The various main switch positions are described below.

### ON

EAU10480

All electrical systems are supplied with power, and the headlight, meter lighting and taillight come on, and the engine can be started. The key cannot be removed.

### OFF

EAU45751

All electrical systems are off. The key can be removed.

## **WARNING**

EWA10072

Never turn the key to “OFF” while the vehicle is moving, otherwise the electrical systems will be switched off, which may result in loss of control or an accident.

## Indicator lights

EAU10981

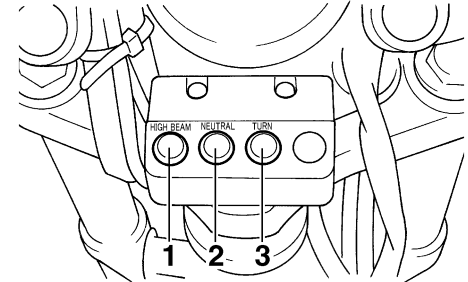

1. High beam indicator light “HIGH BEAM”
2. Neutral indicator light “NEUTRAL”
3. Turn signal indicator light “TURN”

### Turn signal indicator light “TURN”

EAU11040

This indicator light flashes when the turn signal switch is pushed to the left or right.

### Neutral indicator light “NEUTRAL”

EAU11070

This indicator light comes on when the transmission is in the neutral position.

# INSTRUMENT AND CONTROL FUNCTIONS

EAU11090

## High beam indicator light “HIGH BEAM”

This indicator light comes on when the high beam of the headlight is switched on.

EAU11630

## Speedometer unit

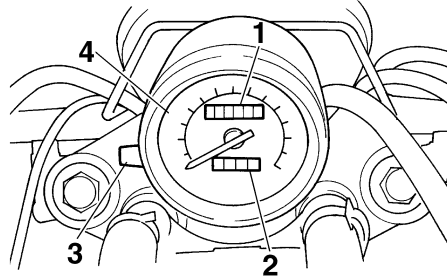

1. Odometer
2. Tripmeter
3. Tripmeter reset knob
4. Speedometer

The speedometer unit is equipped with a speedometer, an odometer and a tripmeter. The speedometer shows riding speed. The odometer shows the total distance traveled. The tripmeter shows the distance traveled since it was last set to zero with the reset knob. The tripmeter can be used to estimate the distance that can be traveled with a full tank of fuel. This information will enable you to plan future fuel stops.

EAU12348

## Handlebar switches

### Left

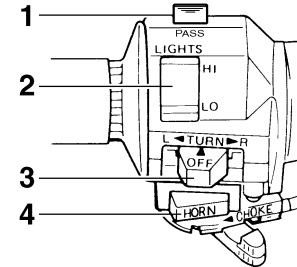

1. Pass switch “PASS”
2. Dimmer switch “LIGHTS”
3. Turn signal switch “TURN”
4. Horn switch “HORN”

# INSTRUMENT AND CONTROL FUNCTIONS

## Right

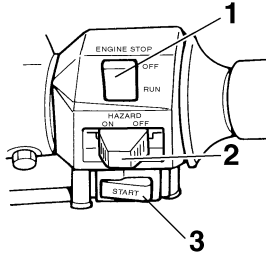

1. Engine stop switch “ENGINE STOP”
2. Hazard switch “HAZARD”
3. Start switch “START”

### Pass switch “PASS”

EAU12360

Press this switch to flash the headlight.

### Dimmer switch “LIGHTS”

EAU12410

Set the switch to “HI” for the high beam and to “LO” for the low beam.

### Turn signal switch “TURN”

EAU12440

To signal a right-hand turn, push this switch to the right. To signal a left-hand turn, push this switch to the left. When released, the switch returns to the cen-

ter position. To cancel the turn signal lights, push the switch in after it has returned to the center position.

### Horn switch “HORN”

EAU12510

Press this switch to sound the horn.

### Engine stop switch “ENGINE STOP”

EAU12650

Set this switch to “RUN” before starting the engine. Set this switch to “OFF” to stop the engine in case of an emergency, such as when the vehicle overturns or when the throttle cable is stuck.

### Start switch “START”

EAU12691

Push this switch to crank the engine with the starter. See page 6-1 for starting instructions prior to starting the engine.

### Hazard switch “HAZARD”

EAU12752

With the key in the “ON” position, use this switch to turn on the hazard lights (simultaneous flashing of all turn signal lights).

The hazard lights are used in case of an emergency or to warn other drivers when your vehicle is stopped where it might be a traffic hazard.

ECA10061

### NOTICE

**Do not use the hazard lights for an extended length of time with the engine not running, otherwise the battery may discharge.**

# INSTRUMENT AND CONTROL FUNCTIONS

## Clutch lever

EAU12820

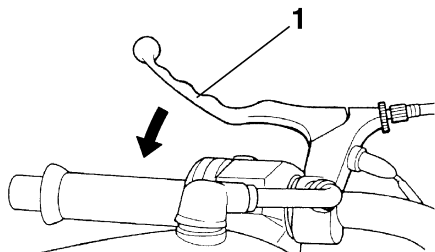

1. Clutch lever

The clutch lever is located at the left handlebar grip. To disengage the clutch, pull the lever toward the handlebar grip. To engage the clutch, release the lever. The lever should be pulled rapidly and released slowly for smooth clutch operation.

The clutch lever is equipped with a clutch switch, which is part of the ignition circuit cut-off system. (See page 4-11.)

## Shift pedal

EAU12870

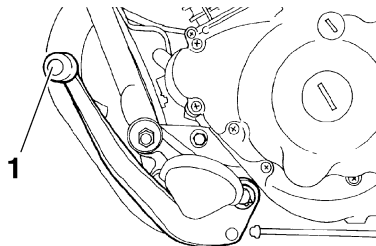

1. Shift pedal

The shift pedal is located on the left side of the engine and is used in combination with the clutch lever when shifting the gears of the 5-speed constant-mesh transmission equipped on this motorcycle.

## Brake lever

EAU12890

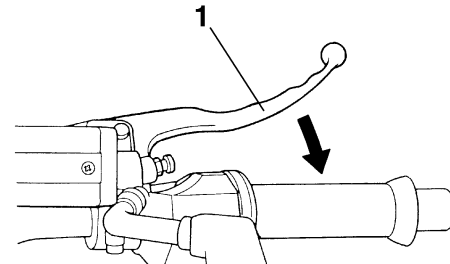

1. Brake lever

The brake lever is located at the right handlebar grip. To apply the front brake, pull the lever toward the handlebar grip.

# INSTRUMENT AND CONTROL FUNCTIONS

## Brake pedal

EAU12941

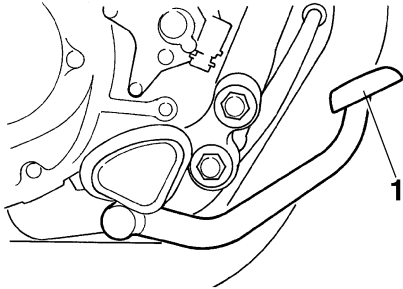

1. Brake pedal

The brake pedal is on the right side of the motorcycle. To apply the rear brake, press down on the brake pedal.

## Fuel tank cap

EAU13041

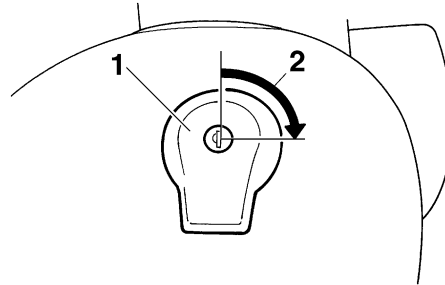

1. Fuel tank cap
2. Unlock.

### To open the fuel tank cap

Insert the key into the lock and turn it 1/4 turn clockwise. The lock will be released and the fuel tank cap can be opened.

### To close the fuel tank cap

1. Push the fuel tank cap into position with the key inserted in the lock.
2. Turn the key counterclockwise to the original position, and then remove it.

## TIP

The fuel tank cap cannot be closed unless the key is in the lock. In addition, the key cannot be removed if the cap is not properly closed and locked.

EWA11091

## WARNING

**Make sure that the fuel tank cap is properly closed after filling fuel. Leaking fuel is a fire hazard.**

# INSTRUMENT AND CONTROL FUNCTIONS

## Fuel

Make sure there is sufficient gasoline in the tank.

EAU13212

EWA10881

### WARNING

Gasoline and gasoline vapors are extremely flammable. To avoid fires and explosions and to reduce the risk of injury when refueling, follow these instructions.

1. Before refueling, turn off the engine and be sure that no one is sitting on the vehicle. Never refuel while smoking, or while in the vicinity of sparks, open flames, or other sources of ignition such as the pilot lights of water heaters and clothes dryers.
2. Do not overfill the fuel tank. Stop filling when the fuel reaches the bottom of the filler tube. Because fuel expands when it heats up, heat from the engine or the sun can cause fuel to spill out of the fuel tank.

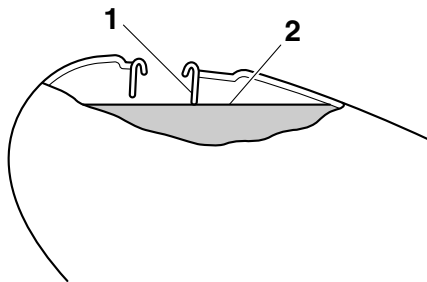

1. Fuel tank filler tube
2. Fuel level

3. Wipe up any spilled fuel immediately. **NOTICE: Immediately wipe off spilled fuel with a clean, dry, soft cloth, since fuel may deteriorate painted surfaces or plastic parts.** (ECA10071)
4. Be sure to securely close the fuel tank cap.

EWA15151

### WARNING

Gasoline is poisonous and can cause injury or death. Handle gasoline with care. Never siphon gasoline by mouth. If you should swallow some gasoline or inhale a lot of gasoline vapor, or get some gasoline in your eyes, see your doctor immedi-

ately. If gasoline spills on your skin, wash with soap and water. If gasoline spills on your clothing, change your clothes.

EAU13332

**Recommended fuel:**  
UNLEADED GASOLINE ONLY  
**Fuel tank capacity:**  
9.5 L (2.51 US gal, 2.09 Imp.gal)  
**Fuel reserve amount:**  
2.6 L (0.69 US gal, 0.57 Imp.gal)

ECA11400

### NOTICE

Use only unleaded gasoline. The use of leaded gasoline will cause severe damage to internal engine parts, such as the valves and piston rings, as well as to the exhaust system.

Your Yamaha engine has been designed to use regular unleaded gasoline with a research octane number of 91 or higher. If knocking (or pinging) occurs, use a gasoline of a different brand or premium unleaded fuel. Use of unleaded fuel will extend spark plug life and reduce maintenance costs.

# INSTRUMENT AND CONTROL FUNCTIONS

EAU13581

## Fuel cock

This model is equipped with a negative pressure fuel cock. The fuel cock supplies fuel from the tank to the carburetor while also filtering it.

The fuel cock lever positions are explained as follows and shown in the illustrations.

### ON

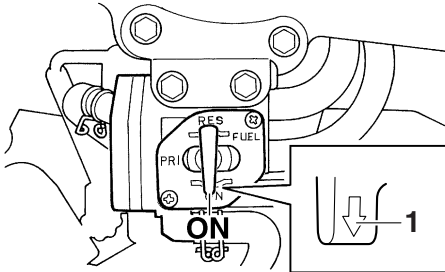

1. Arrow mark positioned over "ON"

With the fuel cock lever in this position, fuel flows to the carburetor when the engine is running. Turn the fuel cock lever to this position when starting the engine and riding.

### RES

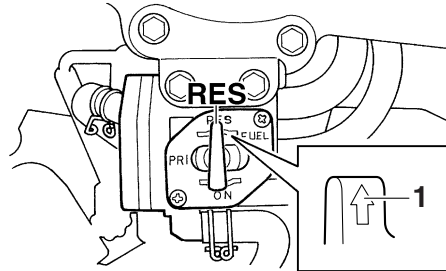

1. Arrow mark positioned over "RES"

This indicates reserve. With the fuel cock lever in this position, the fuel reserve is made available. Quickly turn the fuel cock lever to this position if you run out of fuel while riding, otherwise the engine may stall and will have to be primed (see "PRI"). After turning the fuel cock lever to "RES", refuel as soon as possible and be sure to turn the fuel cock lever back to "ON"!

### PRI

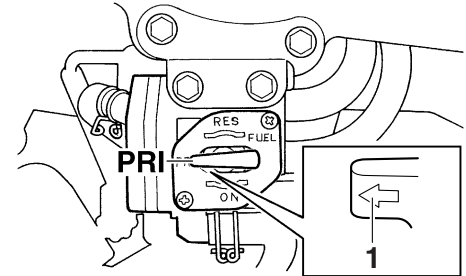

1. Arrow mark positioned over "PRI"

This indicates prime. With the fuel cock lever in this position, the engine can be "primed". Turn the fuel cock lever to this position when the engine has been allowed to run out of fuel. This sends fuel directly to the carburetor, which will make starting easier. After the engine has started, be sure to turn the lever to "ON" (or "RES" if you have not refueled yet).

# INSTRUMENT AND CONTROL FUNCTIONS

## Starter (choke) lever

EAU13630

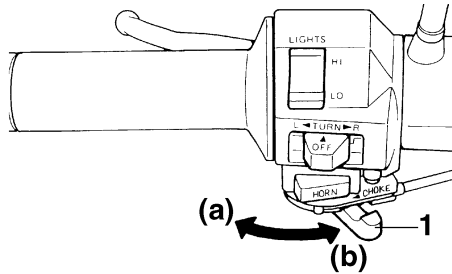

1. Starter (choke) lever

Starting a cold engine requires a richer air-fuel mixture, which is supplied by the starter (choke).

Move the lever in direction (a) to turn on the starter (choke).

Move the lever in direction (b) to turn off the starter (choke).

## Steering lock

EAU13730

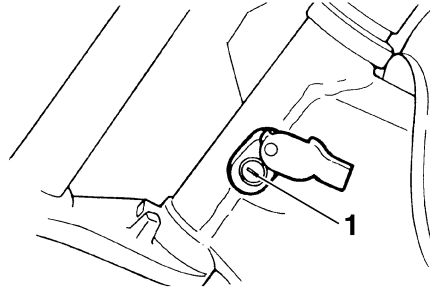

1. Steering lock

### To lock the steering

1. Turn the handlebar all the way to the right.
2. Open the steering lock cover, and then insert the key.
3. Turn the key 1/8 turn counterclockwise, push it in while turning the handlebar slightly to the left, and then turn the key 1/8 turn clockwise.
4. Check that the steering is locked, remove the key, and then close the lock cover.

### To unlock the steering

1. Open the steering lock cover, and then insert the key.
2. Push the key in, turn it 1/8 turn counterclockwise so that it moves out, and then release it.
3. Remove the key, and then close the lock cover.



## Rider seat

EAU14220

### To remove the rider seat

Remove the bolts, and then pull the rider seat off.

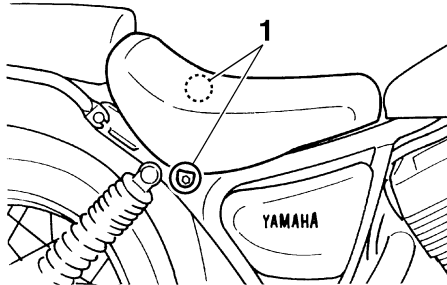

1. Bolt

### To install the rider seat

1. Insert the projection on the front of the rider seat into the seat holder as shown.

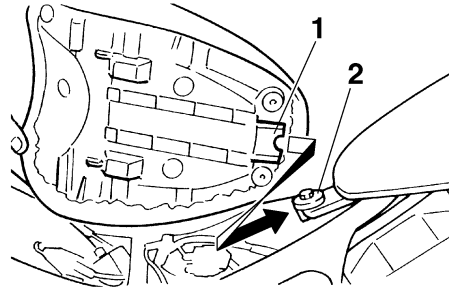

1. Projection
2. Seat holder

2. Place the rider seat in the original position, and then tighten the bolts.

### TIP

Make sure that the rider seat is properly secured before riding.

## Helmet holder

EAU14282

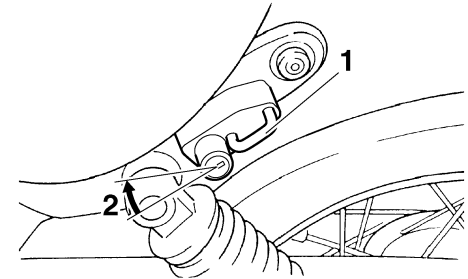

1. Helmet holder
2. Unlock.

To open the helmet holder, insert the key into the lock, and then turn the key as shown.

To lock the helmet holder, place it in the original position, and then remove the key. **WARNING! Never ride with a helmet attached to the helmet holder, since the helmet may hit objects, causing loss of control and possibly an accident.** [EWA10161]

# INSTRUMENT AND CONTROL FUNCTIONS

## Adjusting the shock absorber assemblies

EAU14882

EWA10210

### **⚠ WARNING**

Always adjust both shock absorber assemblies equally, otherwise poor handling and loss of stability may result.

Each shock absorber assembly is equipped with a spring preload adjusting ring.

ECA10101

### **NOTICE**

To avoid damaging the mechanism, do not attempt to turn beyond the maximum or minimum settings.

Adjust the spring preload as follows.

To increase the spring preload and thereby harden the suspension, turn the adjusting ring on each shock absorber assembly in direction (a). To decrease the spring preload and thereby soften the suspension, turn the adjusting ring on each shock absorber assembly in direction (b).

Align the appropriate notch in the adjusting ring with the position indicator on the shock absorber.

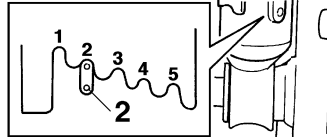
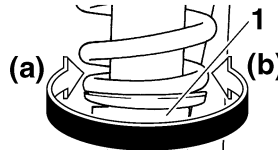

1. Spring preload adjusting ring
2. Position indicator

### Spring preload setting:

Minimum (soft):

1

Standard:

2

Maximum (hard):

5

## Sidestand

EAU15303

The sidestand is located on the left side of the frame. Raise the sidestand or lower it with your foot while holding the vehicle upright.

### TIP

The built-in sidestand switch is part of the ignition circuit cut-off system, which cuts the ignition in certain situations. (See page 4-11 for an explanation of the ignition circuit cut-off system.)

EWA10240

### **⚠ WARNING**

The vehicle must not be ridden with the sidestand down, or if the sidestand cannot be properly moved up (or does not stay up), otherwise the sidestand could contact the ground and distract the operator, resulting in a possible loss of control. Yamaha's ignition circuit cut-off system has been designed to assist the operator in fulfilling the responsibility of raising the sidestand before starting off. Therefore, check this system regularly as described

below and have a Yamaha dealer repair it if it does not function properly.

---

EAU48240

## Ignition circuit cut-off system

The ignition circuit cut-off system (comprising the sidestand switch, clutch switch and neutral switch) has the following functions.

- It prevents starting when the transmission is in gear and the sidestand is up, but the clutch lever is not pulled.
- It prevents starting when the transmission is in gear and the clutch lever is pulled, but the sidestand is still down.
- It cuts the running engine when the transmission is in gear and the sidestand is moved down.

Periodically check the operation of the ignition circuit cut-off system according to the following procedure.

### TIP

---

This check is most reliable if performed with a warmed-up engine.

---

# INSTRUMENT AND CONTROL FUNCTIONS

4

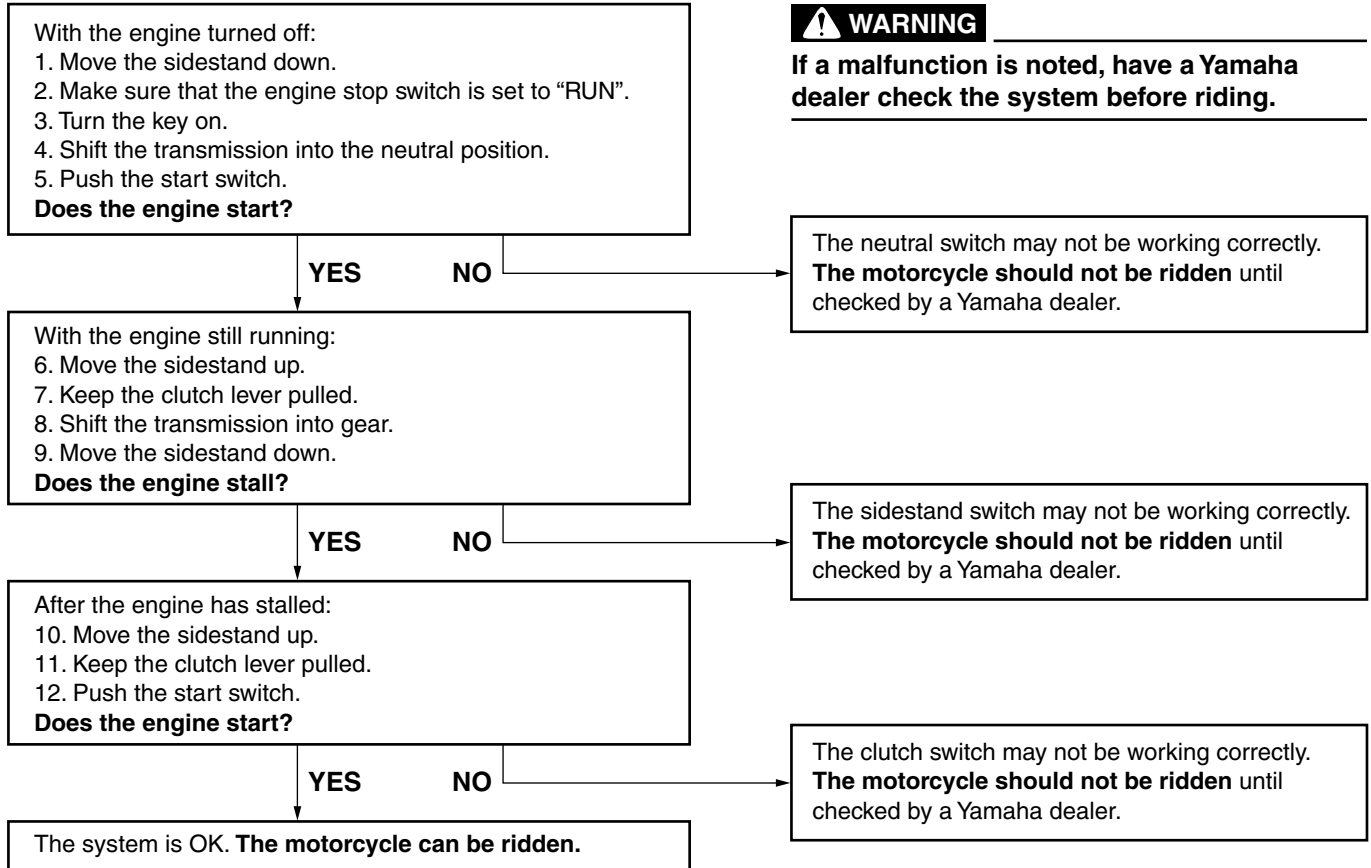

# FOR YOUR SAFETY – PRE-OPERATION CHECKS

EAU15596

Inspect your vehicle each time you use it to make sure the vehicle is in safe operating condition. Always follow the inspection and maintenance procedures and schedules described in the Owner's Manual.

EWA11151

## **WARNING**

**Failure to inspect or maintain the vehicle properly increases the possibility of an accident or equipment damage. Do not operate the vehicle if you find any problem. If a problem cannot be corrected by the procedures provided in this manual, have the vehicle inspected by a Yamaha dealer.**

Before using this vehicle, check the following points:

ITEM	CHECKS	PAGE
Fuel	<ul style="list-style-type: none"><li>• Check fuel level in fuel tank.</li><li>• Refuel if necessary.</li><li>• Check fuel line for leakage.</li></ul>	4-6
Engine oil	<ul style="list-style-type: none"><li>• Check oil level in engine.</li><li>• If necessary, add recommended oil to specified level.</li><li>• Check vehicle for oil leakage.</li></ul>	7-9
Front brake	<ul style="list-style-type: none"><li>• Check operation.</li><li>• If soft or spongy, have Yamaha dealer bleed hydraulic system.</li><li>• Check lever free play.</li><li>• Adjust if necessary.</li><li>• Check brake pads for wear.</li><li>• Replace if necessary.</li><li>• Check fluid level in reservoir.</li><li>• If necessary, add recommended brake fluid to specified level.</li><li>• Check hydraulic system for leakage.</li></ul>	7-18, 7-20, 7-21
Rear brake	<ul style="list-style-type: none"><li>• Check operation.</li><li>• Lubricate cable if necessary.</li><li>• Check pedal free play.</li><li>• Adjust if necessary.</li></ul>	7-19, 7-20

# FOR YOUR SAFETY – PRE-OPERATION CHECKS

ITEM	CHECKS	PAGE
<b>Clutch</b>	<ul style="list-style-type: none"> <li>• Check operation.</li> <li>• Lubricate cable if necessary.</li> <li>• Check lever free play.</li> <li>• Adjust if necessary.</li> </ul>	7-17
<b>Throttle grip</b>	<ul style="list-style-type: none"> <li>• Make sure that operation is smooth.</li> <li>• Check cable free play.</li> <li>• If necessary, have Yamaha dealer adjust cable free play and lubricate cable and grip housing.</li> </ul>	7-14, 7-25
<b>Control cables</b>	<ul style="list-style-type: none"> <li>• Make sure that operation is smooth.</li> <li>• Lubricate if necessary.</li> </ul>	7-24
<b>Drive chain</b>	<ul style="list-style-type: none"> <li>• Check chain slack.</li> <li>• Adjust if necessary.</li> <li>• Check chain condition.</li> <li>• Lubricate if necessary.</li> </ul>	7-22, 7-24
<b>Wheels and tires</b>	<ul style="list-style-type: none"> <li>• Check for damage.</li> <li>• Check tire condition and tread depth.</li> <li>• Check air pressure.</li> <li>• Correct if necessary.</li> </ul>	7-15, 7-16
<b>Brake and shift pedals</b>	<ul style="list-style-type: none"> <li>• Make sure that operation is smooth.</li> <li>• Lubricate pedal pivoting points if necessary.</li> </ul>	7-25
<b>Brake and clutch levers</b>	<ul style="list-style-type: none"> <li>• Make sure that operation is smooth.</li> <li>• Lubricate lever pivoting points if necessary.</li> </ul>	7-26
<b>Sidestand</b>	<ul style="list-style-type: none"> <li>• Make sure that operation is smooth.</li> <li>• Lubricate pivot if necessary.</li> </ul>	7-26
<b>Chassis fasteners</b>	<ul style="list-style-type: none"> <li>• Make sure that all nuts, bolts and screws are properly tightened.</li> <li>• Tighten if necessary.</li> </ul>	—
<b>Instruments, lights, signals and switches</b>	<ul style="list-style-type: none"> <li>• Check operation.</li> <li>• Correct if necessary.</li> </ul>	—
<b>Sidestand switch</b>	<ul style="list-style-type: none"> <li>• Check operation of ignition circuit cut-off system.</li> <li>• If system is not working correctly, have Yamaha dealer check vehicle.</li> </ul>	4-10

# FOR YOUR SAFETY – PRE-OPERATION CHECKS

ITEM	CHECKS	PAGE
Battery	<ul style="list-style-type: none"><li>• Check fluid level.</li><li>• Fill with distilled water if necessary.</li></ul>	7-28

# OPERATION AND IMPORTANT RIDING POINTS

---

EAU15951

Read the Owner's Manual carefully to become familiar with all controls. If there is a control or function you do not understand, ask your Yamaha dealer.

EWA10271

## **WARNING**

**Failure to familiarize yourself with the controls can lead to loss of control, which could cause an accident or injury.**

---

EAU32633

## Starting and warming up a cold engine

In order for the ignition circuit cut-off system to enable starting, one of the following conditions must be met:

- The transmission is in the neutral position.
- The transmission is in gear with the clutch lever pulled and the sidestand up.  
See page 4-11 for more information.

1. Turn the fuel cock lever to "ON".
2. Turn the key to "ON" and make sure that the engine stop switch is set to "RUN".
3. Shift the transmission into the neutral position. (See page 6-2.) The neutral indicator light should come on. If not, ask a Yamaha dealer to check the electrical circuit.
4. Turn the starter (choke) on and completely close the throttle. (See page 4-8.)
5. Start the engine by pushing the start switch.

If the engine fails to start, release the start switch, wait a few seconds, and then try again. Each starting attempt should be as short as possible to preserve the battery. Do not crank the engine more than 10 seconds on any one attempt.

6. After starting the engine, move the starter (choke) back halfway.  
**NOTICE: For maximum engine life, never accelerate hard when the engine is cold!** [ECA11041]
7. When the engine is warm, turn the starter (choke) off.

## **TIP**

The engine is warm when it responds normally to the throttle with the starter (choke) turned off.

---



# OPERATION AND IMPORTANT RIDING POINTS

## Starting a warm engine

EAU16640

Follow the same procedure as for starting a cold engine with the exception that the starter (choke) is not required when the engine is warm.

## Shifting

EAU16671

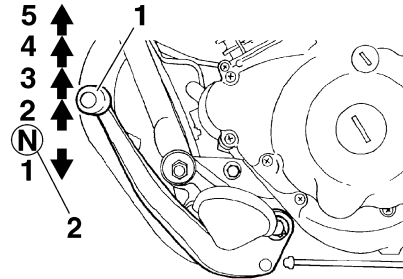

1. Shift pedal
2. Neutral position

Shifting gears lets you control the amount of engine power available for starting off, accelerating, climbing hills, etc.

The gear positions are shown in the illustration.

### TIP

To shift the transmission into the neutral position, press the shift pedal down repeatedly until it reaches the end of its travel, and then slightly raise it.

### NOTICE

- Even with the transmission in the neutral position, do not coast for long periods of time with the engine off, and do not tow the motorcycle for long distances. The transmission is properly lubricated only when the engine is running. Inadequate lubrication may damage the transmission.
- Always use the clutch while changing gears to avoid damaging the engine, transmission, and drive train, which are not designed to withstand the shock of forced shifting.

# OPERATION AND IMPORTANT RIDING POINTS

---

## Tips for reducing fuel consumption

EAU16800

Fuel consumption depends largely on your riding style. Consider the following tips to reduce fuel consumption:

- Turn the starter (choke) off as soon as possible.
- Shift up swiftly, and avoid high engine speeds during acceleration.
- Do not rev the engine while shifting down, and avoid high engine speeds with no load on the engine.
- Turn the engine off instead of letting it idle for an extended length of time (e.g., in traffic jams, at traffic lights or at railroad crossings).

## Engine break-in

EAU16841

There is never a more important period in the life of your engine than the period between 0 and 1600 km (1000 mi). For this reason, you should read the following material carefully.

Since the engine is brand new, do not put an excessive load on it for the first 1600 km (1000 mi). The various parts in the engine wear and polish themselves to the correct operating clearances. During this period, prolonged full-throttle operation or any condition that might result in engine overheating must be avoided.

EAU17023

## 0–1000 km (0–600 mi)

Avoid prolonged operation above 1/3 throttle. **NOTICE: After 1000 km (600 mi) of operation, the engine oil must be changed, and the oil filter cartridge or element replaced.** [ECA11282]

## 1000–1600 km (600–1000 mi)

Avoid prolonged operation above 1/2 throttle.

## 1600 km (1000 mi) and beyond

The vehicle can now be operated normally.

ECA10270

### **NOTICE**

**If any engine trouble should occur during the engine break-in period, immediately have a Yamaha dealer check the vehicle.**

EAU17201

## Parking

When parking, stop the engine, and then remove the key from the main switch.

EWA10311

### **WARNING**

- **Since the engine and exhaust system can become very hot, park in a place where pedestrians or children are not likely to touch them and be burned.**
  - **Do not park on a slope or on soft ground, otherwise the vehicle may overturn, increasing the risk of a fuel leak and fire.**
  - **Do not park near grass or other flammable materials which might catch fire.**
-

# PERIODIC MAINTENANCE AND ADJUSTMENT

EAU17241

Periodic inspection, adjustment, and lubrication will keep your vehicle in the safest and most efficient condition possible. Safety is an obligation of the vehicle owner/operator. The most important points of vehicle inspection, adjustment, and lubrication are explained on the following pages.

The intervals given in the periodic maintenance and lubrication chart should be simply considered as a general guide under normal riding conditions. However, depending on the weather, terrain, geographical location, and individual use, the maintenance intervals may need to be shortened.

EWA10321

## **WARNING**

**Failure to properly maintain the vehicle or performing maintenance activities incorrectly may increase your risk of injury or death during service or while using the vehicle. If you are not familiar with vehicle service, have a Yamaha dealer perform service.**

EWA15121

## **WARNING**

**Turn off the engine when performing maintenance unless otherwise specified.**

- **A running engine has moving parts that can catch on body parts or clothing and electrical parts that can cause shocks or fires.**
- **Running the engine while servicing can lead to eye injury, burns, fire, or carbon monoxide poisoning – possibly leading to death. See page 2-1 for more information about carbon monoxide.**

EAU17341

## Owner's tool kit

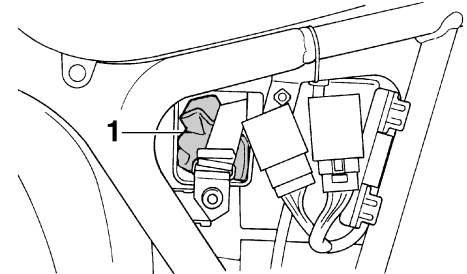

1. Owner's tool kit

The owner's tool kit is located behind panel A. (See page 7-7.)

The service information included in this manual and the tools provided in the owner's tool kit are intended to assist you in the performance of preventive maintenance and minor repairs. However, additional tools such as a torque wrench may be necessary to perform certain maintenance work correctly.

## **TIP**

If you do not have the tools or experience required for a particular job, have a Yamaha dealer perform it for you.

# PERIODIC MAINTENANCE AND ADJUSTMENT

EAU46861

## TIP

- The annual checks must be performed every year, except if a kilometer-based maintenance, or for the UK, a mileage-based maintenance, is performed instead.
- From 50000 km (30000 mi), repeat the maintenance intervals starting from 10000 km (6000 mi).
- Items marked with an asterisk should be performed by a Yamaha dealer as they require special tools, data and technical skills.

EAU46910

## Periodic maintenance chart for the emission control system

NO.	ITEM	CHECK OR MAINTENANCE JOB	ODOMETER READING					ANNUAL CHECK
			1000 km (600 mi)	10000 km (6000 mi)	20000 km (12000 mi)	30000 km (18000 mi)	40000 km (24000 mi)	
1	* Fuel line	<ul style="list-style-type: none"> <li>• Check fuel and vacuum hoses for cracks or damage.</li> </ul>		√	√	√	√	√
2	Spark plugs	<ul style="list-style-type: none"> <li>• Check condition.</li> <li>• Clean and regap.</li> </ul>		√		√		
		<ul style="list-style-type: none"> <li>• Replace.</li> </ul>			√		√	
3	* Valves	<ul style="list-style-type: none"> <li>• Check valve clearance.</li> <li>• Adjust.</li> </ul>		√	√	√	√	
4	* Carburetor	<ul style="list-style-type: none"> <li>• Check starter (choke) operation.</li> <li>• Adjust engine idling speed.</li> </ul>	√	√	√	√	√	√

# PERIODIC MAINTENANCE AND ADJUSTMENT

EAU1770C

## General maintenance and lubrication chart

NO.	ITEM	CHECK OR MAINTENANCE JOB	ODOMETER READING					ANNUAL CHECK
			1000 km (600 mi)	10000 km (6000 mi)	20000 km (12000 mi)	30000 km (18000 mi)	40000 km (24000 mi)	
1	Air filter element	• Clean.		√		√		
		• Replace.			√		√	
2	* Battery	• Check electrolyte level and specific gravity. • Make sure that the breather hose is properly routed.		√	√	√	√	√
3	Clutch	• Check operation. • Adjust.	√	√	√	√	√	
4	* Front brake	• Check operation, fluid level and vehicle for fluid leakage. • Adjust brake lever free play.	√	√	√	√	√	√
		• Replace brake pads.	Whenever worn to the limit					
5	* Rear brake	• Check operation and adjust brake pedal free play.	√	√	√	√	√	√
		• Replace brake shoes.	Whenever worn to the limit					
6	* Brake hose	• Check for cracks or damage.		√	√	√	√	√
		• Replace.	Every 4 years					
7	* Wheels	• Check runout, spoke tightness and for damage. • Tighten spokes if necessary.		√	√	√	√	
8	* Tires	• Check tread depth and for damage. • Replace if necessary. • Check air pressure. • Correct if necessary.		√	√	√	√	√

7

# PERIODIC MAINTENANCE AND ADJUSTMENT

NO.	ITEM	CHECK OR MAINTENANCE JOB	ODOMETER READING					ANNUAL CHECK
			1000 km (600 mi)	10000 km (6000 mi)	20000 km (12000 mi)	30000 km (18000 mi)	40000 km (24000 mi)	
9	* Wheel bearings	<ul style="list-style-type: none"> <li>• Check bearing for looseness or damage.</li> </ul>		√	√	√	√	
10	* Swingarm pivot bushes	<ul style="list-style-type: none"> <li>• Check bush assemblies for looseness.</li> </ul>		√	√	√	√	
		<ul style="list-style-type: none"> <li>• Lubricate with lithium-soap-based grease.</li> </ul>	Every 10000 km (6000 mi)					
11	Drive chain	<ul style="list-style-type: none"> <li>• Check chain slack, alignment and condition.</li> <li>• Adjust and lubricate chain with a special O-ring chain lubricant thoroughly.</li> </ul>	Every 1000 km (600 mi) and after washing the motorcycle or riding in the rain					
12	* Steering bearings	<ul style="list-style-type: none"> <li>• Check bearing play and steering for roughness.</li> </ul>	√	√	√	√	√	
		<ul style="list-style-type: none"> <li>• Lubricate with lithium-soap-based grease.</li> </ul>	Every 20000 km (12000 mi)					
13	* Chassis fasteners	<ul style="list-style-type: none"> <li>• Make sure that all nuts, bolts and screws are properly tightened.</li> </ul>		√	√	√	√	√
14	Brake lever pivot shaft	<ul style="list-style-type: none"> <li>• Lubricate with silicone grease.</li> </ul>		√	√	√	√	√
15	Brake pedal pivot shaft	<ul style="list-style-type: none"> <li>• Lubricate with lithium-soap-based grease.</li> </ul>		√	√	√	√	√
16	Clutch lever pivot shaft	<ul style="list-style-type: none"> <li>• Lubricate with lithium-soap-based grease.</li> </ul>		√	√	√	√	√
17	Shift pedal pivot shaft	<ul style="list-style-type: none"> <li>• Lubricate with lithium-soap-based grease.</li> </ul>		√	√	√	√	√
18	Sidestand	<ul style="list-style-type: none"> <li>• Check operation.</li> <li>• Lubricate.</li> </ul>		√	√	√	√	√

# PERIODIC MAINTENANCE AND ADJUSTMENT

NO.	ITEM	CHECK OR MAINTENANCE JOB	ODOMETER READING					ANNUAL CHECK
			1000 km (600 mi)	10000 km (6000 mi)	20000 km (12000 mi)	30000 km (18000 mi)	40000 km (24000 mi)	
19	* Sidestand switch	• Check operation.	√	√	√	√	√	√
20	* Front fork	• Check operation and for oil leakage.		√	√	√	√	
21	* Shock absorber assemblies	• Check operation and shock absorbers for oil leakage.		√	√	√	√	
22	Engine oil	• Change. • Check oil level and vehicle for oil leakage.	√	√	√	√	√	√
23	Engine oil filter element	• Replace.	√		√		√	
24	* Front and rear brake switches	• Check operation.	√	√	√	√	√	√
25	Moving parts and cables	• Lubricate.		√	√	√	√	√
26	* Throttle grip housing and cable	• Check operation and free play. • Adjust the throttle cable free play if necessary. • Lubricate the throttle grip housing and cable.		√	√	√	√	√
27	* Lights, signals and switches	• Check operation. • Adjust headlight beam.	√	√	√	√	√	√

7

EAU18660

## TIP

- The air filter needs more frequent service if you are riding in unusually wet or dusty areas.



# PERIODIC MAINTENANCE AND ADJUSTMENT

---

- Hydraulic brake service
    - Regularly check and, if necessary, correct the brake fluid level.
    - Every two years replace the internal components of the brake master cylinder and caliper, and change the brake fluid.
    - Replace the brake hoses every four years and if cracked or damaged.
-

# PERIODIC MAINTENANCE AND ADJUSTMENT

## Removing and installing the panel

EAU18751

The panel shown needs to be removed to perform some of the maintenance jobs described in this chapter. Refer to this section each time the panel needs to be removed and installed.

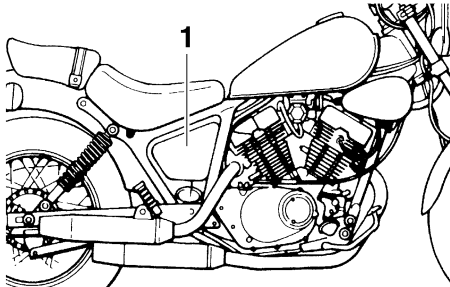

1. Panel A

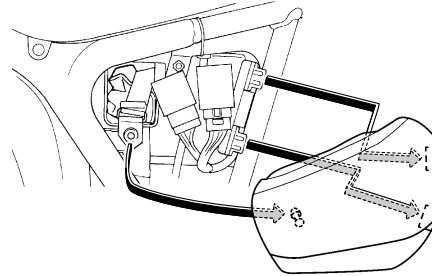

### To install the panel

Secure the front of the panel, and then push the rear of the panel in.

## Panel A

EAU19510

### To remove the panel

Pull the rear of the panel out, and then slide the panel forward to release it in the front.

## Checking the spark plugs

EAU19545

The spark plugs are important engine components, which are easy to check. Since heat and deposits will cause any spark plug to slowly erode, the spark plugs should be removed and checked in accordance with the periodic maintenance and lubrication chart. In addition, the condition of the spark plugs can reveal the condition of the engine.

### To remove a spark plug

1. Remove the spark plug cap.

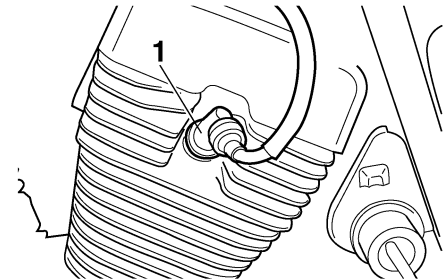

1. Spark plug cap

2. Remove the spark plug as shown, with the spark plug wrench included in the owner's tool kit.

# PERIODIC MAINTENANCE AND ADJUSTMENT

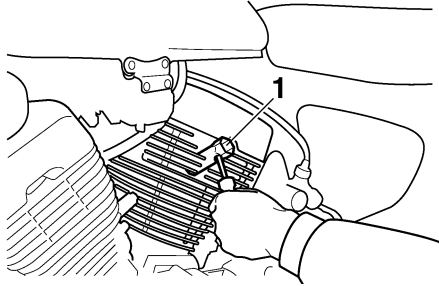

1. Spark plug wrench

## To check the spark plugs

1. Check that the porcelain insulator around the center electrode on each spark plug is a medium-to-light tan (the ideal color when the vehicle is ridden normally).
2. Check that all spark plugs installed in the engine have the same color.

## TIP

If any spark plug shows a distinctly different color, the engine could be operating improperly. Do not attempt to diagnose such problems yourself. Instead, have a Yamaha dealer check the vehicle.

3. Check each spark plug for electrode erosion and excessive carbon or other deposits, and replace it if necessary.

### Specified spark plug:

NGK/C6HSA  
DENSO/U20FS-U

4. Measure the spark plug gap with a wire thickness gauge and, if necessary, adjust the gap to specification.

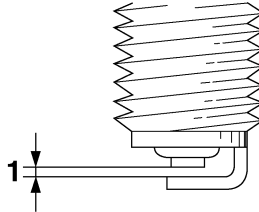

1. Spark plug gap

### Spark plug gap:

0.6–0.7 mm (0.024–0.028 in)

## To install a spark plug

1. Clean the surface of the spark plug gasket and its mating surface, and then wipe off any grime from the spark plug threads.
2. Install the spark plug with the spark plug wrench, and then tighten it to the specified torque.

### Tightening torque:

Spark plug:  
12.5 Nm (1.25 m·kgf, 9.0 ft·lbf)

## TIP

If a torque wrench is not available when installing a spark plug, a good estimate of the correct torque is 1/4–1/2 turn past finger tight. However, the spark plug should be tightened to the specified torque as soon as possible.

3. Install the spark plug cap.

# PERIODIC MAINTENANCE AND ADJUSTMENT

EAU42103

## Engine oil and oil filter element

The engine oil level should be checked before each ride. In addition, the oil must be changed and the oil filter element replaced at the intervals specified in the periodic maintenance and lubrication chart.

### To check the engine oil level

1. Place the vehicle on a level surface and hold it in an upright position. A slight tilt to the side can result in a false reading.
2. Start the engine, warm it up for several minutes, and then turn it off.
3. Wait a few minutes until the oil settles, and then check the oil level through the check window located at the bottom-right side of the crankcase.

**TIP** \_\_\_\_\_  
The engine oil should be between the minimum and maximum level marks.

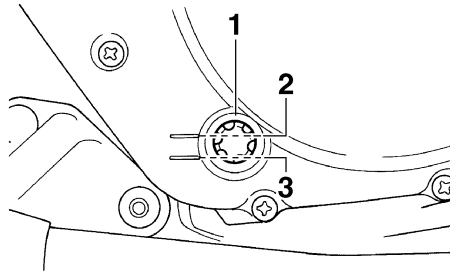

1. Engine oil level check window
2. Maximum level mark
3. Minimum level mark

4. If the engine oil is below the minimum level mark, add sufficient oil of the recommended type to raise it to the correct level.

### To change the engine oil (with or without oil filter element replacement)

1. Start the engine, warm it up for several minutes, and then turn it off.
2. Place an oil pan under the engine to collect the used oil.
3. Remove the engine oil filler cap and drain bolt to drain the oil from the crankcase.

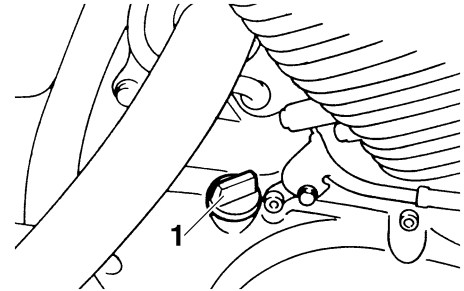

1. Engine oil filler cap

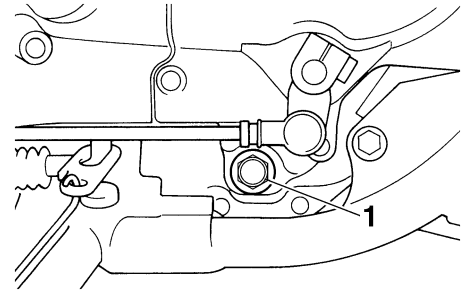

1. Engine oil drain bolt

**TIP** \_\_\_\_\_  
Skip steps 4–6 if the oil filter element is not being replaced.

4. Remove the oil filter element cover by removing the screws.

# PERIODIC MAINTENANCE AND ADJUSTMENT

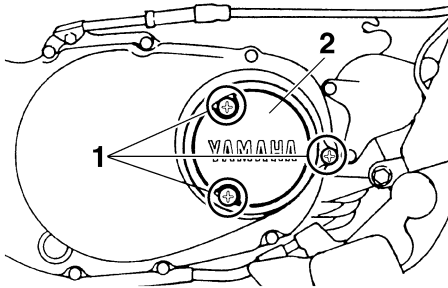

1. Screw
2. Oil filter element cover

5. Remove and replace the oil filter element and O-ring.

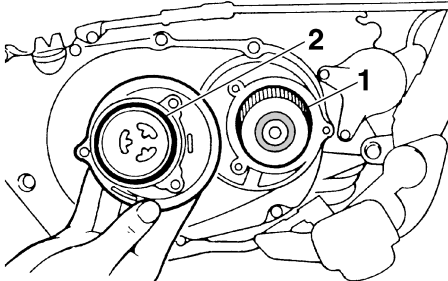

1. Oil filter element
2. O-ring

6. Install the oil filter element cover by installing the screws, then tightening them to the specified torque.

## Tightening torque:

Oil filter element cover screw:  
10 Nm (1.0 m·kgf, 7.2 ft·lbf)

## TIP

Make sure that the O-ring is properly seated.

7. Install the engine oil drain bolt, and then tighten it to the specified torque.

## TIP

Check the washer for damage and replace it if necessary.

## Tightening torque:

Engine oil drain bolt:  
34 Nm (3.4 m·kgf, 24 ft·lbf)

8. Refill with the specified amount of the recommended engine oil, and then install and tighten the oil filler cap.

## Recommended engine oil:

See page 9-1.

## Oil quantity:

With oil filter element replacement:

1.60 L (1.69 US qt, 1.41 Imp.qt)

Without oil filter element replacement:

1.40 L (1.48 US qt, 1.23 Imp.qt)

## TIP

Be sure to wipe off spilled oil on any parts after the engine and exhaust system have cooled down.

ECA11620

## NOTICE

- In order to prevent clutch slippage (since the engine oil also lubricates the clutch), do not mix any chemical additives. Do not use oils with a diesel specification of “CD” or oils of a higher quality than specified. In addition, do not use oils labeled “ENERGY CONSERVING II” or higher.
- Make sure that no foreign material enters the crankcase.

# PERIODIC MAINTENANCE AND ADJUSTMENT

9. Start the engine, and then let it idle for several minutes while checking it for oil leakage. If oil is leaking, immediately turn the engine off and check for the cause.
10. Turn the engine off, and then check the oil level and correct it if necessary.

## Cleaning the air filter element

EAU32738

The air filter element should be cleaned or replaced at the intervals specified in the periodic maintenance and lubrication chart. Clean or, if necessary, replace the air filter element more frequently if you are riding in unusually wet or dusty areas.

1. Remove the bolts and loosen the air filter case joint clamp screw.

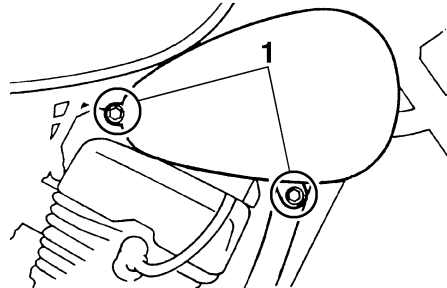

1. Bolt

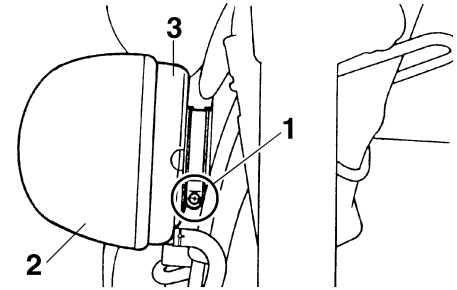

1. Air filter case joint clamp screw
2. Air filter case cover
3. Air filter case

2. Disconnect the hoses from the air filter case, and then remove the air filter case.

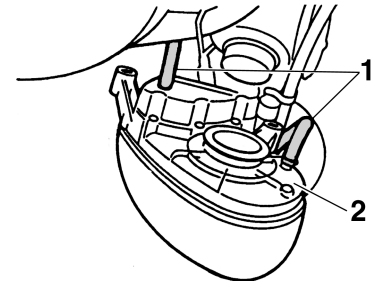

1. Hose
2. Air filter case

# PERIODIC MAINTENANCE AND ADJUSTMENT

3. Remove the air filter case cover by removing the screws.

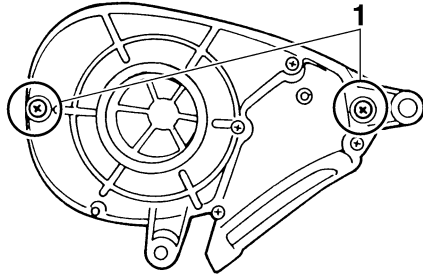

1. Screw

4. Remove the air filter element by removing the wing nut.

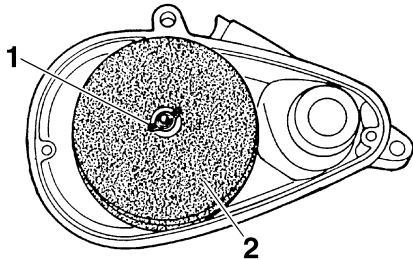

1. Wing nut  
2. Air filter element

5. Remove the sponge material from the air filter element frame, clean it with solvent, and then squeeze the remaining solvent out. **WARNING! Use only a dedicated parts cleaning solvent. To avoid the risk of fire or explosion, do not use gasoline or solvents with a low flash point.** [EWA10431] **NOTICE: To avoid damaging the foam material, handle it gently and carefully, and do not twist or wring it.** [ECA10511]

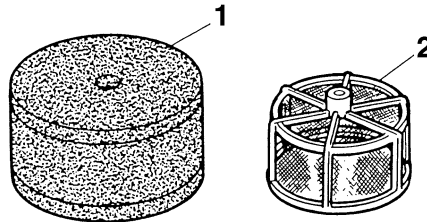

1. Sponge material  
2. Air filter element frame

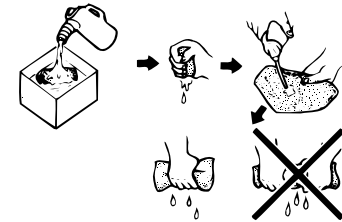

6. Apply oil of the recommended type to the entire surface of the sponge material, and then squeeze the excess oil out.

## TIP

The air filter element should be wet but not dripping.

### Recommended oil:

Yamaha foam air filter oil or other quality foam air filter oil

7. Pull the sponge material over the air filter element frame.
8. Insert the element into the air filter case, and then tighten the wing nut. **NOTICE: Make sure that the air filter element is properly seated in the air filter case. The**

# PERIODIC MAINTENANCE AND ADJUSTMENT

engine should never be operated without the air filter element installed, otherwise the piston(s) and/or cylinder(s) may become excessively worn.

[ECA10481]

9. Install the air filter case cover by installing the screws.
10. Connect the hoses to the air filter case.
11. Push the air filter case onto the air filter case joint, and then tighten the clamp screw.
12. Install the air filter case bolts.

## Adjusting the carburetor

EAU21280

The carburetor is an important part of the engine and requires very sophisticated adjustment. Therefore, most carburetor adjustments should be left to a Yamaha dealer, who has the necessary professional knowledge and experience. The adjustment described in the following section, however, may be serviced by the owner as part of routine maintenance.

ECA10550

### **NOTICE**

**The carburetor has been set and extensively tested at the Yamaha factory. Changing these settings without sufficient technical knowledge may result in poor performance of or damage to the engine.**

EAU21340

## Adjusting the engine idling speed

The engine idling speed must be checked and, if necessary, adjusted as follows at the intervals specified in the periodic maintenance and lubrication chart.

The engine should be warm before making this adjustment.

### **TIP**

- The engine is warm when it quickly responds to the throttle.
- A diagnostic tachometer is needed to make this adjustment.

1. Attach the tachometer to the spark plug lead.
2. Check the engine idling speed and, if necessary, adjust it to specification by turning the throttle stop screw. To increase the engine idling speed, turn the screw in direction (a). To decrease the engine idling speed, turn the screw in direction (b).



# PERIODIC MAINTENANCE AND ADJUSTMENT

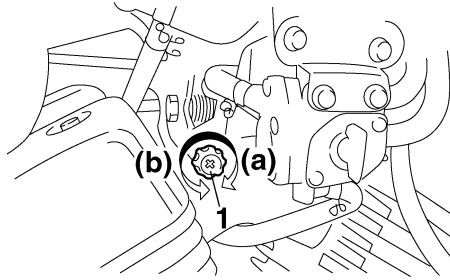

1. Throttle stop screw

**Engine idling speed:**  
1250–1350 r/min

## TIP

If the specified idling speed cannot be obtained as described above, have a Yamaha dealer make the adjustment.

EAU21382

## Checking the throttle cable free play

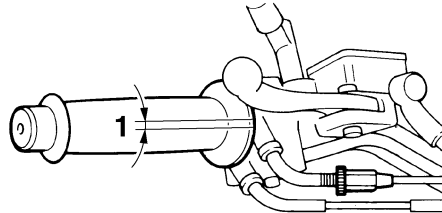

1. Throttle cable free play

The throttle cable free play should measure 3.0–5.0 mm (0.12–0.20 in) at the throttle grip. Periodically check the throttle cable free play and, if necessary, have a Yamaha dealer adjust it.

EAU21401

## Valve clearance

The valve clearance changes with use, resulting in improper air-fuel mixture and/or engine noise. To prevent this from occurring, the valve clearance must be adjusted by a Yamaha dealer at the intervals specified in the periodic maintenance and lubrication chart.

# PERIODIC MAINTENANCE AND ADJUSTMENT

## Tires

EAU32773

To maximize the performance, durability, and safe operation of your motorcycle, note the following points regarding the specified tires.

### Tire air pressure

The tire air pressure should be checked and, if necessary, adjusted before each ride.

EWA10501

#### **WARNING**

Operation of this vehicle with improper tire pressure may cause severe injury or death from loss of control.

- The tire air pressure must be checked and adjusted on cold tires (i.e., when the temperature of the tires equals the ambient temperature).
- The tire air pressure must be adjusted in accordance with the riding speed and with the total weight of rider, passenger, cargo, and accessories approved for this model.

**Tire air pressure (measured on cold tires):**

**0–90 kg (0–198 lb):**

Front:

175 kPa (1.75 kgf/cm<sup>2</sup>, 25 psi)

Rear:

200 kPa (2.00 kgf/cm<sup>2</sup>, 29 psi)

**90–196 kg (198–432 lb):**

Front:

200 kPa (2.00 kgf/cm<sup>2</sup>, 29 psi)

Rear:

225 kPa (2.25 kgf/cm<sup>2</sup>, 33 psi)

**Maximum load\*:**

196 kg (432 lb)

\* Total weight of rider, passenger, cargo and accessories

EWA10511

#### **WARNING**

Never overload your vehicle. Operation of an overloaded vehicle could cause an accident.

## Tire inspection

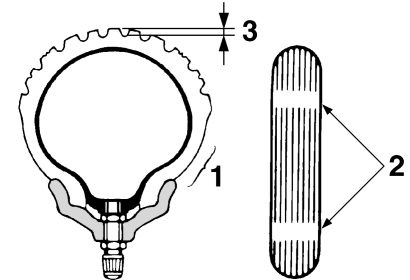

1. Tire sidewall
2. Tire wear indicator
3. Tire tread depth

Always check the tires before operating the motorcycle. If a tire tread shows crosswise lines (minimum tread depth), if the tire has a nail or glass fragments in it, or if the sidewall is cracked, contact a Yamaha dealer immediately and have the tire replaced.

**Minimum tire tread depth (front and rear):**

1.0 mm (0.04 in)

# PERIODIC MAINTENANCE AND ADJUSTMENT

## TIP \_\_\_\_\_

The tire tread depth limits may differ from country to country. Always comply with the local regulations.

## WARNING \_\_\_\_\_

EWA10561

- It is dangerous to ride with a worn-out tire. When a tire tread begins to show crosswise lines, have a Yamaha dealer replace the tire immediately.
- The replacement of all wheel and brake-related parts, including the tires, should be left to a Yamaha dealer, who has the necessary professional knowledge and experience.
- It is not recommended to patch a punctured tube. If unavoidable, however, patch the tube very carefully and replace it as soon as possible with a high-quality product.

## Tire information

This motorcycle is equipped with spoke wheels and tube tires.

## WARNING \_\_\_\_\_

EWA10461

The front and rear tires should be of the same make and design, otherwise the handling characteristics of the vehicle may be different, which could lead to an accident.

After extensive tests, only the tires listed below have been approved for this model by Yamaha Motor Co., Ltd.

### Front tire:

Size:

3.00-18 47P

Manufacturer/model:

CHENG SHIN/C-916

### Rear tire:

Size:

130/90-15M/C 66P

Manufacturer/model:

CHENG SHIN/C-915

## Spoke wheels

EAU21941

## WARNING \_\_\_\_\_

EWA10610

The wheels on this model are not designed for use with tubeless tires. Do not attempt to use tubeless tires on this model.

To maximize the performance, durability, and safe operation of your motorcycle, note the following points regarding the specified wheels.

- The wheel rims should be checked for cracks, bends or warpage, and the spokes for looseness or damage before each ride. If any damage is found, have a Yamaha dealer replace the wheel. Do not attempt even the smallest repair to the wheel. A deformed or cracked wheel must be replaced.
- The wheel should be balanced whenever either the tire or wheel has been changed or replaced. An unbalanced wheel can result in poor performance, adverse handling characteristics, and a shortened tire life.

# PERIODIC MAINTENANCE AND ADJUSTMENT

- Ride at moderate speeds after changing a tire since the tire surface must first be “broken in” for it to develop its optimal characteristics.

## Adjusting the clutch lever free play

EAU22043

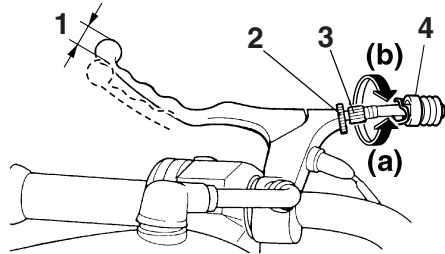

1. Clutch lever free play
2. Locknut
3. Clutch lever free play adjusting bolt
4. Rubber cover

The clutch lever free play should measure 10.0–15.0 mm (0.39–0.59 in) as shown. Periodically check the clutch lever free play and, if necessary, adjust it as follows.

1. Slide the rubber cover back at the clutch lever.
2. Loosen the locknut.

3. To increase the clutch lever free play, turn the adjusting bolt in direction (a). To decrease the clutch lever free play, turn the adjusting bolt in direction (b).

### TIP

If the specified clutch lever free play could be obtained as described above, skip steps 4–7.

4. Fully turn the adjusting bolt at the clutch lever in direction (a) to loosen the clutch cable.
5. Loosen the locknut at the crankcase.

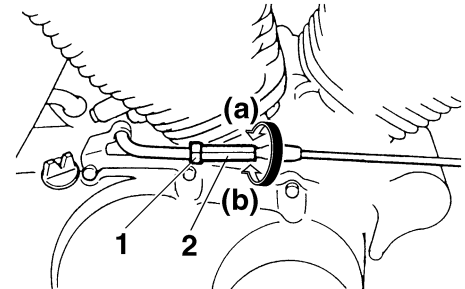

1. Locknut
2. Clutch lever free play adjusting nut (crankcase)

# PERIODIC MAINTENANCE AND ADJUSTMENT

- To increase the clutch lever free play, turn the adjusting nut in direction (a). To decrease the clutch lever free play, turn the adjusting nut in direction (b).
- Tighten the locknut at the crankcase.
- Tighten the locknut at the clutch lever and then slide the rubber cover to its original position.

## Adjusting the brake lever free play

EAU22093

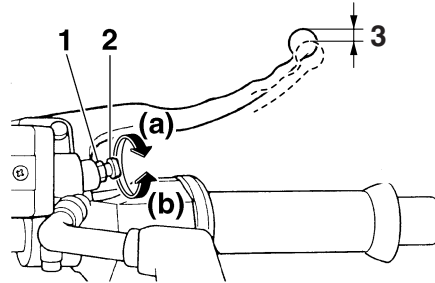

- Locknut
- Brake lever free play adjusting screw
- Brake lever free play

The brake lever free play should measure 2.0–5.0 mm (0.08–0.20 in) as shown. Periodically check the brake lever free play and, if necessary, adjust it as follows.

- Loosen the locknut at the brake lever.
- To increase the brake lever free play, turn the brake lever free play adjusting screw in direction (a). To decrease the brake lever free play, turn the adjusting screw in direction (b).

- Tighten the locknut.

EWA10630

### **! WARNING**

- After adjusting the brake lever free play, check the free play and make sure that the brake is working properly.
- A soft or spongy feeling in the brake lever can indicate the presence of air in the hydraulic system. If there is air in the hydraulic system, have a Yamaha dealer bleed the system before operating the motorcycle. Air in the hydraulic system will diminish the braking performance, which may result in loss of control and an accident.

# PERIODIC MAINTENANCE AND ADJUSTMENT

## Adjusting the brake pedal position and free play

EAU22201

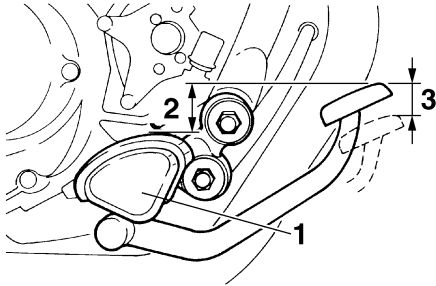

1. Footrest
2. Distance between brake pedal and footrest
3. Brake pedal free play

EWA10670

### **⚠ WARNING**

It is advisable to have a Yamaha dealer make these adjustments.

### Brake pedal position

The top of the brake pedal should be positioned approximately 60.0 mm (2.36 in) above the top of the footrest as shown. Periodically check the brake pedal position and, if necessary, adjust it as follows.

1. Loosen the locknut at the brake pedal.
2. To raise the brake pedal, turn the adjusting bolt in direction (a). To lower the brake pedal, turn the adjusting bolt in direction (b).

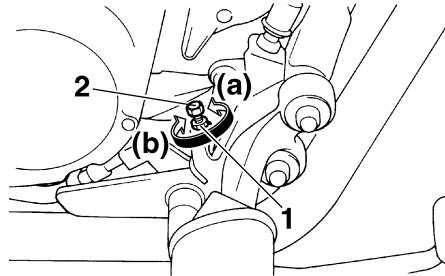

1. Locknut
2. Brake pedal position adjusting bolt
3. Tighten the locknut.

EWA11230

### **⚠ WARNING**

After adjusting the brake pedal position, the brake pedal free play must be adjusted.

### Brake pedal free play

The brake pedal free play should measure 20.0–30.0 mm (0.79–1.18 in) at the brake pedal end. Periodically check the brake pedal free play and, if necessary, adjust it as follows.

To increase the brake pedal free play, turn the adjusting nut at the brake rod in direction (a). To decrease the brake pedal free play, turn the adjusting nut in direction (b).

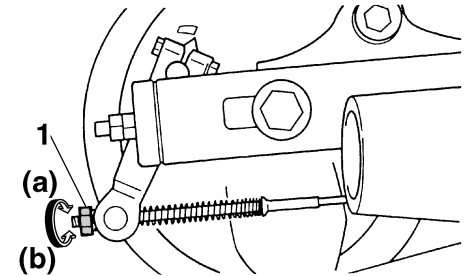

1. Brake pedal free play adjusting nut

EWA10680

### **⚠ WARNING**

- After adjusting the drive chain slack or removing and installing the rear wheel, always check the brake pedal free play.

# PERIODIC MAINTENANCE AND ADJUSTMENT

- If proper adjustment cannot be obtained as described, have a Yamaha dealer make this adjustment.
- After adjusting the brake pedal free play, check the operation of the brake light.

## Adjusting the rear brake light switch EAU22272

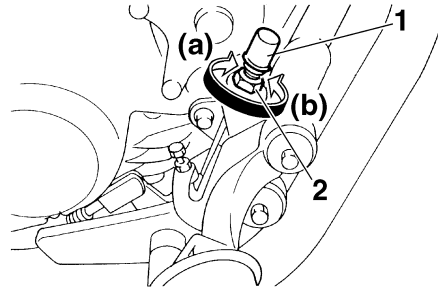

1. Rear brake light switch
2. Rear brake light switch adjusting nut

The rear brake light, which is activated by the brake pedal, should come on just before braking takes effect. If necessary, adjust the rear brake light switch as follows.

Turn the rear brake light switch adjusting nut while holding the rear brake light switch in place. To make the brake light come on earlier, turn the adjusting nut in direction (a). To make the brake light come on later, turn the adjusting nut in direction (b).

## Checking the front brake pads and rear brake shoes EAU22380

The front brake pads and the rear brake shoes must be checked for wear at the intervals specified in the periodic maintenance and lubrication chart.

### Front brake pads EAU22420

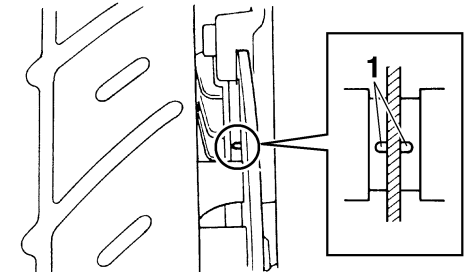

1. Brake pad wear indicator groove

Each front brake pad is provided with a wear indicator groove, which allows you to check the brake pad wear without having to disassemble the brake. To check the brake pad wear, check the wear indicator groove. If a brake pad has worn to the point that the wear

# PERIODIC MAINTENANCE AND ADJUSTMENT

indicator groove has almost disappeared, have a Yamaha dealer replace the brake pads as a set.

## Rear brake shoes

EAU22540

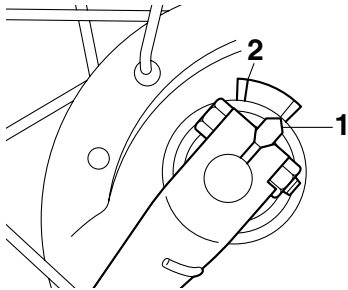

1. Brake shoe wear indicator
2. Brake shoe wear limit line

7

The rear brake is provided with a wear indicator, which allows you to check the brake shoe wear without having to disassemble the brake. To check the brake shoe wear, check the position of the wear indicator while applying the brake. If a brake shoe has worn to the point that the wear indicator reaches the wear limit line, have a Yamaha dealer replace the brake shoes as a set.

## Checking the brake fluid level

EAU32344

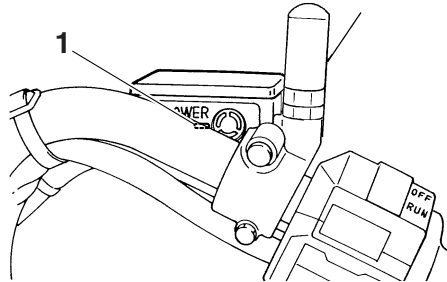

1. Minimum level mark

Insufficient brake fluid may allow air to enter the brake system, possibly causing it to become ineffective.

Before riding, check that the brake fluid is above the minimum level mark and replenish if necessary. A low brake fluid level may indicate worn brake pads and/or brake system leakage. If the brake fluid level is low, be sure to check the brake pads for wear and the brake system for leakage.

Observe these precautions:

- When checking the fluid level, make sure that the top of the master cylinder is level by turning the handlebars.

- Use only the recommended quality brake fluid, otherwise the rubber seals may deteriorate, causing leakage and poor braking performance.

**Recommended brake fluid:**  
DOT 4

- Refill with the same type of brake fluid. Mixing fluids may result in a harmful chemical reaction and lead to poor braking performance.
- Be careful that water does not enter the master cylinder when refilling. Water will significantly lower the boiling point of the fluid and may result in vapor lock.
- Brake fluid may deteriorate painted surfaces or plastic parts. Always clean up spilled fluid immediately.
- As the brake pads wear, it is normal for the brake fluid level to gradually go down. However, if the brake fluid level goes down suddenly, have a Yamaha dealer check the cause.



# PERIODIC MAINTENANCE AND ADJUSTMENT

## Changing the brake fluid

EAU22721

Have a Yamaha dealer change the brake fluid at the intervals specified in the TIP after the periodic maintenance and lubrication chart. In addition, have the oil seals of the brake master cylinder and caliper as well as the brake hose replaced at the intervals listed below or whenever they are damaged or leaking.

- Oil seals: Replace every two years.
- Brake hose: Replace every four years.

## Drive chain slack

EAU22760

The drive chain slack should be checked before each ride and adjusted if necessary.

### To check the drive chain slack

EAU22773

1. Place the motorcycle on the side-stand.

### TIP

When checking and adjusting the drive chain slack, there should be no weight on the motorcycle.

2. Shift the transmission into the neutral position.
3. Move the rear wheel by pushing the motorcycle to locate the tightest portion of the drive chain, and then measure the drive chain slack as shown.

#### Drive chain slack:

30.0–40.0 mm (1.18–1.57 in)

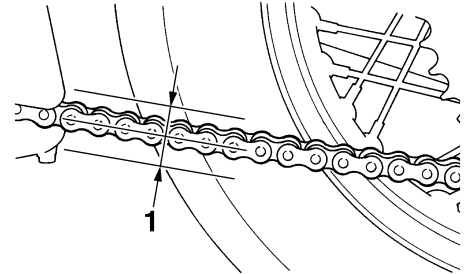

1. Drive chain slack

4. If the drive chain slack is incorrect, adjust it as follows.

### To adjust the drive chain slack

EAU22861

1. Loosen the brake pedal free play adjusting nut.

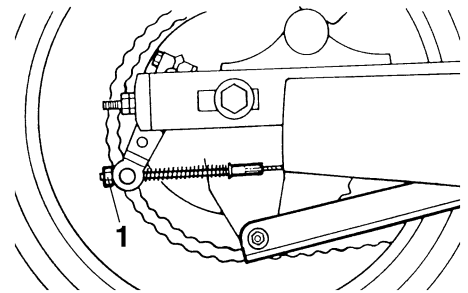

1. Brake pedal free play adjusting nut

# PERIODIC MAINTENANCE AND ADJUSTMENT

2. Remove the cotter pin from the axle nut, and then loosen the axle nut.
3. Loosen the chain puller locknut at each end of the swingarm.
4. To tighten the drive chain, turn the drive chain slack adjusting nut at each end of the swingarm in direction (a). To loosen the drive chain, turn the adjusting nut at each end of the swingarm in direction (b), and then push the rear wheel forward. **NOTICE: Improper drive chain slack will overload the engine as well as other vital parts of the motorcycle and can lead to chain slippage or breakage. To prevent this from occurring, keep the drive chain slack within the specified limits.** [ECA10571]

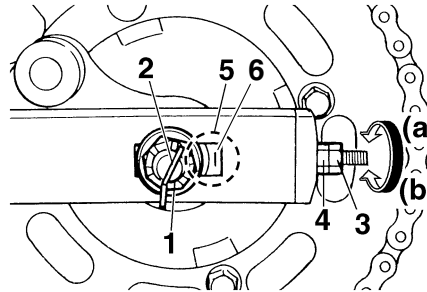

1. Axle nut
2. Axle nut cotter pin
3. Chain puller locknut
4. Drive chain slack adjusting nut
5. Alignment marks
6. Drive chain puller

## Tightening torque:

Axle nut:  
104 Nm (10.4 m·kgf, 75 ft·lbf)

5. Tighten the locknuts, and then tighten the axle nut to the specified torque.
6. Insert a new cotter pin into the axle nut, and then bend its ends as shown. **WARNING! Always use a new cotter pin for the axle nut.**

[EWA10701]

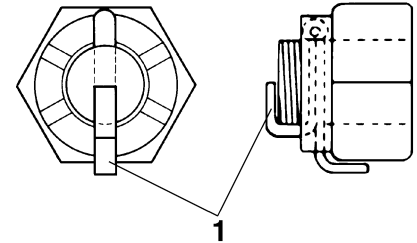

1. Cotter pin

## TIP

Make sure that two notches in the axle nut are aligned with the hole through the wheel axle, otherwise further tightening the axle nut until they are.

7. Adjust the brake pedal free play. (See page 7-19.)

EWA10660

## WARNING

**After adjusting the brake pedal free play, check the operation of the brake light.**

## TIP

Using the alignment marks on each side of the swingarm, make sure that both chain pullers are in the same position for proper wheel alignment.

# PERIODIC MAINTENANCE AND ADJUSTMENT

## Cleaning and lubricating the drive chain

EAU23024

The drive chain must be cleaned and lubricated at the intervals specified in the periodic maintenance and lubrication chart, otherwise it will quickly wear out, especially when riding in dusty or wet areas. Service the drive chain as follows.

ECA10582

### **NOTICE**

**The drive chain must be lubricated after washing the motorcycle and riding in the rain or wet areas.**

1. Clean the drive chain with kerosene and a small soft brush.  
**NOTICE: To prevent damaging the O-rings, do not clean the drive chain with steam cleaners, high-pressure washers or inappropriate solvents.** [ECA11121]
2. Wipe the drive chain dry.
3. Thoroughly lubricate the drive chain with a special O-ring chain lubricant. **NOTICE: Do not use engine oil or any other lubricants for the drive chain, as they**

may contain substances that could damage the O-rings.

[ECA11111]

## Checking and lubricating the cables

EAU23101

The operation of all control cables and the condition of the cables should be checked before each ride, and the cables and cable ends should be lubricated if necessary. If a cable is damaged or does not move smoothly, have a Yamaha dealer check or replace it. **WARNING! Damage to the outer sheath may interfere with proper cable operation and will cause the inner cable to rust. Replace a damaged cable as soon as possible to prevent unsafe conditions.** [EWA10721]

**Recommended lubricant:**  
Engine oil

# PERIODIC MAINTENANCE AND ADJUSTMENT

## Checking and lubricating the throttle grip and cable

EAU23111

The operation of the throttle grip should be checked before each ride. In addition, the cable should be lubricated at the intervals specified in the periodic maintenance chart.

## Checking and lubricating the brake and shift pedals

EAU44271

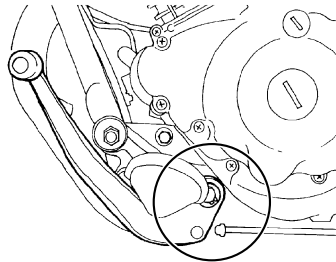
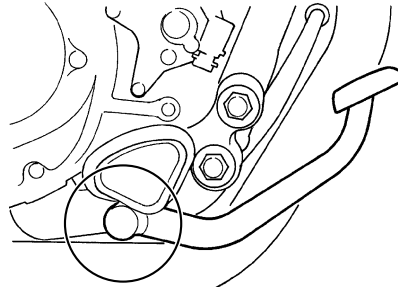

**Recommended lubricant:**  
Lithium-soap-based grease

The operation of the brake and shift pedals should be checked before each ride, and the pedal pivots should be lubricated if necessary.

# PERIODIC MAINTENANCE AND ADJUSTMENT

## Checking and lubricating the brake and clutch levers

EAU23142

### Brake lever

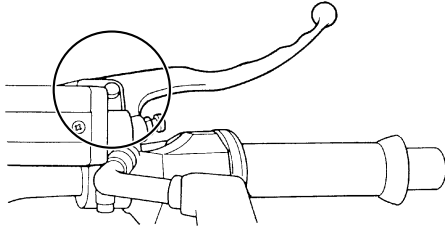

### Clutch lever

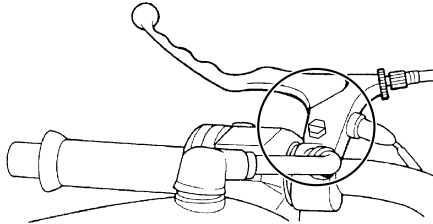

The operation of the brake and clutch levers should be checked before each ride, and the lever pivots should be lubricated if necessary.

### Recommended lubricants:

- Brake lever:  
Silicone grease
- Clutch lever:  
Lithium-soap-based grease

## Checking and lubricating the sidestand

EAU23202

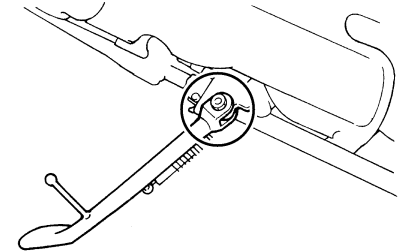

The operation of the sidestand should be checked before each ride, and the sidestand pivot and metal-to-metal contact surfaces should be lubricated if necessary.

EWA10731

### **⚠ WARNING**

**If the sidestand does not move up and down smoothly, have a Yamaha dealer check or repair it. Otherwise, the sidestand could contact the ground and distract the operator, resulting in a possible loss of control.**

### Recommended lubricant:

- Lithium-soap-based grease

# PERIODIC MAINTENANCE AND ADJUSTMENT

## Lubricating the swingarm pivots

EAUM1650

The swingarm pivots must be lubricated at the intervals specified in the periodic maintenance and lubrication chart.

### Recommended lubricant:

Lithium-soap-based grease

## Checking the front fork

EAU23272

The condition and operation of the front fork must be checked as follows at the intervals specified in the periodic maintenance and lubrication chart.

### To check the condition

Check the inner tubes for scratches, damage and excessive oil leakage.

### To check the operation

1. Place the vehicle on a level surface and hold it in an upright position. **WARNING! To avoid injury, securely support the vehicle so there is no danger of it falling over.** [EWA10751]
2. While applying the front brake, push down hard on the handlebars several times to check if the front fork compresses and rebounds smoothly.

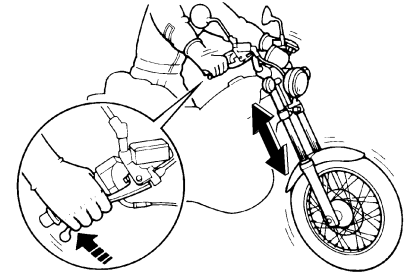

ECA10590

### NOTICE

**If any damage is found or the front fork does not operate smoothly, have a Yamaha dealer check or repair it.**

EAU23283

## Checking the steering

Worn or loose steering bearings may cause danger. Therefore, the operation of the steering must be checked as follows at the intervals specified in the periodic maintenance and lubrication chart.

1. Place a stand under the engine to raise the front wheel off the ground. (See page 7-33 for more information.) **WARNING! To avoid injury, securely support the vehicle so there is no danger of it falling over.** [EWA10751]
2. Hold the lower ends of the front fork legs and try to move them forward and backward. If any free play can be felt, have a Yamaha dealer check or repair the steering.

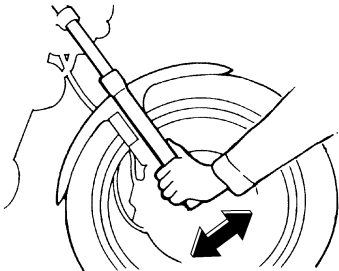

EAU23291

## Checking the wheel bearings

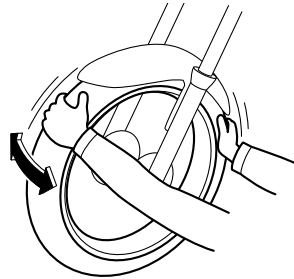

The front and rear wheel bearings must be checked at the intervals specified in the periodic maintenance and lubrication chart. If there is play in the wheel hub or if the wheel does not turn smoothly, have a Yamaha dealer check the wheel bearings.

EAU23312

## Battery

A poorly maintained battery will corrode and discharge quickly. The electrolyte level, battery lead connections and breather hose routing should be checked before each ride and at the intervals specified in the periodic maintenance and lubrication chart.

### To check the electrolyte level

1. Place the vehicle on a level surface and hold it in an upright position.

### TIP \_\_\_\_\_

Make sure that the vehicle is positioned straight up when checking the electrolyte level.

2. Check the electrolyte level in the battery.

### TIP \_\_\_\_\_

The electrolyte should be between the minimum and maximum level marks.

# PERIODIC MAINTENANCE AND ADJUSTMENT

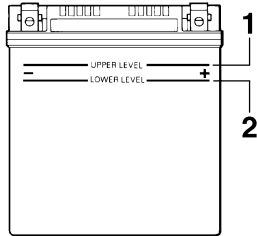

1. Maximum level mark
2. Minimum level mark

3. If the electrolyte is at or below the minimum level mark, add distilled water to raise it to the maximum level mark. **NOTICE: Use only distilled water, as tap water contains minerals that are harmful to the battery.** [ECA10611]

EWA10770

## WARNING

- Electrolyte is poisonous and dangerous since it contains sulfuric acid, which causes severe burns. Avoid any contact with skin, eyes or clothing and always shield your eyes when

working near batteries. In case of contact, administer the following **FIRST AID**.

- **EXTERNAL:** Flush with plenty of water.
- **INTERNAL:** Drink large quantities of water or milk and immediately call a physician.
- **EYES:** Flush with water for 15 minutes and seek prompt medical attention.
- Batteries produce explosive hydrogen gas. Therefore, keep sparks, flames, cigarettes, etc., away from the battery and provide sufficient ventilation when charging it in an enclosed space.
- Take care not to spill electrolyte on the drive chain, as this may weaken it, shorten chain life and possibly result in an accident.
- **KEEP THIS AND ALL BATTERIES OUT OF THE REACH OF CHILDREN.**

4. Check and, if necessary, tighten the battery lead connections and correct the breather hose routing.

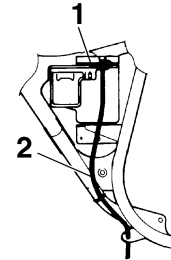

1. Battery
2. Battery breather hose

## To store the battery

1. If the motorcycle will not be used for more than one month, remove the battery, fully charge it, and then place it in a cool, dry place. **NOTICE: When removing the battery, be sure the key is turned to "OFF", then disconnect the negative lead before disconnecting the positive lead.**

[ECA16302]

2. If the battery will be stored for more than two months, check the specific gravity of the electrolyte at least once a month and fully charge the battery whenever necessary.



# PERIODIC MAINTENANCE AND ADJUSTMENT

3. Fully charge the battery before installation.
4. After installation, make sure that the battery leads are properly connected to the battery terminals and that the breather hose is properly routed, in good condition, and not obstructed. **NOTICE:** If the breather hose is positioned in such a way that the frame is exposed to electrolyte or gas expelled from the battery, the frame could suffer structural and external damages. [ECA10601]

## Replacing the fuses

EAU23601

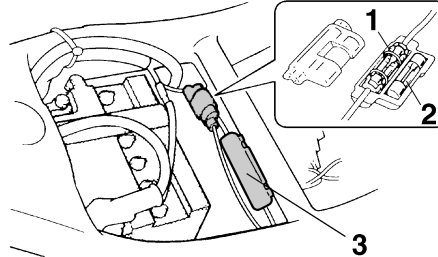

1. Main fuse
2. Spare main fuse
3. Signaling system fuse

The main fuse and the signaling system fuse holders are located under the rider seat. (See page 4-9.)

If a fuse is blown, replace it as follows.

1. Turn the key to “OFF” and turn off the electrical circuit in question.
2. Remove the blown fuse, and then install a new fuse of the specified amperage. **WARNING! Do not use a fuse of a higher amperage rating than recommended to avoid causing extensive damage to the electrical system and possibly a fire.** [EWA15131]

### Specified fuses:

Main fuse:

20.0 A

Signaling system fuse:

10.0 A

3. Turn the key to “ON” and turn on the electrical circuit in question to check if the device operates.
4. If the fuse immediately blows again, have a Yamaha dealer check the electrical system.

# PERIODIC MAINTENANCE AND ADJUSTMENT

EAU23783

## Replacing the headlight bulb

This model is equipped with a quartz bulb headlight. If the headlight bulb burns out, replace it as follows.

ECA10650

### NOTICE

Take care not to damage the following parts:

- **Headlight bulb**

Do not touch the glass part of the headlight bulb to keep it free from oil, otherwise the transparency of the glass, the luminosity of the bulb, and the bulb life will be adversely affected. Thoroughly clean off any dirt and fingerprints on the headlight bulb using a cloth moistened with alcohol or thinner.

- **Headlight lens**

Do not affix any type of tinted film or stickers to the headlight lens.

Do not use a headlight bulb of a wattage higher than specified.

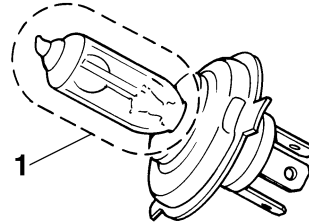

1. Do not touch the glass part of the bulb.

1. Remove the headlight unit by removing the screws.

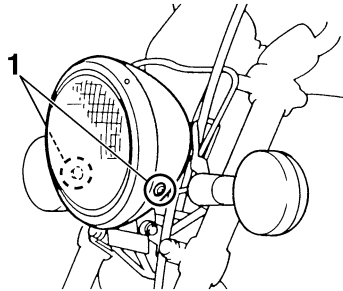

1. Screw

2. Disconnect the headlight coupler, and then remove the bulb cover.

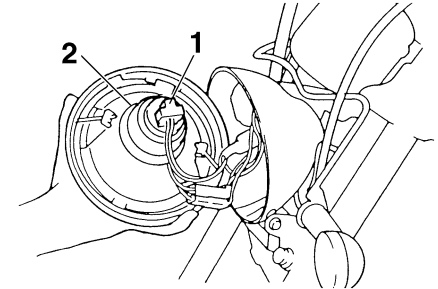

1. Headlight coupler

2. Headlight bulb cover

3. Remove the headlight bulb holder by turning it counterclockwise, and then remove the burnt-out bulb.

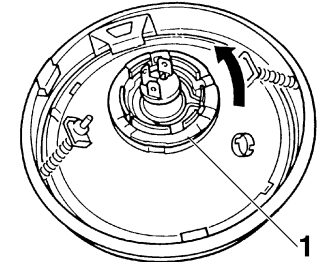

1. Headlight bulb holder

4. Place a new headlight bulb into position, and then secure it with the bulb holder.

# PERIODIC MAINTENANCE AND ADJUSTMENT

5. Install the headlight bulb cover, and then connect the coupler.
6. Install the headlight unit by installing the screws.
7. Have a Yamaha dealer adjust the headlight beam if necessary.

## Replacing the tail/brake light bulb

EAU24133

1. Remove the tail/brake light lens by removing the screws.

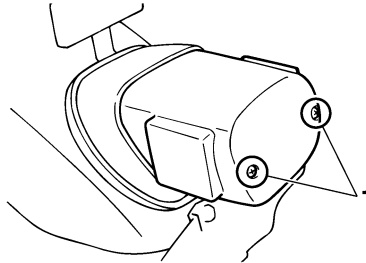

1. Screw

2. Remove the burnt-out bulb by pushing it in and turning it counter-clockwise.

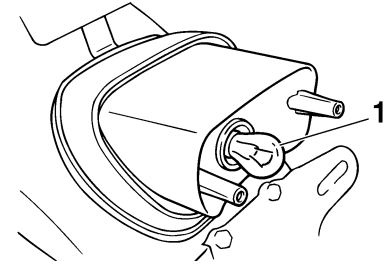

1. Tail/brake light bulb

3. Insert a new bulb into the socket, push it in, and then turn it clockwise until it stops.
4. Install the lens by installing the screws. **NOTICE: Do not over-tighten the screws, otherwise the lens may break.** [ECA10681]

# PERIODIC MAINTENANCE AND ADJUSTMENT

EAU24212

## Replacing a turn signal light bulb

1. Remove the turn signal lens by removing the screws.

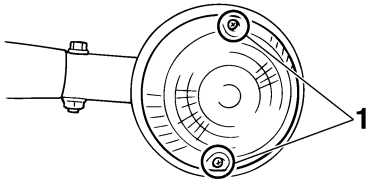

1. Screw

2. Remove the burnt-out bulb by pushing it in and turning it counter-clockwise.

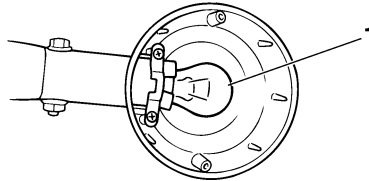

1. Turn signal light bulb
3. Insert a new bulb into the socket, push it in, and then turn it clockwise until it stops.
4. Install the lens by installing the screws. **NOTICE: Do not overtighten the screws, otherwise the lens may break.** [ECA10681]

EAU24350

## Supporting the motorcycle

Since this model is not equipped with a centerstand, follow these precautions when removing the front and rear wheel or performing other maintenance requiring the motorcycle to stand upright. Check that the motorcycle is in a stable and level position before starting any maintenance. A strong wooden box can be placed under the engine for added stability.

### To service the front wheel

1. Stabilize the rear of the motorcycle by using a motorcycle stand or, if an additional motorcycle stand is not available, by placing a jack under the frame in front of the rear wheel.
2. Raise the front wheel off the ground by using a motorcycle stand.

### To service the rear wheel

Raise the rear wheel off the ground by using a motorcycle stand or, if a motorcycle stand is not available, by placing

# PERIODIC MAINTENANCE AND ADJUSTMENT

a jack either under each side of the frame in front of the rear wheel or under each side of the swingarm.

## Front wheel

EAU24360

### To remove the front wheel

EAU24601

EWA10821



**WARNING**

To avoid injury, securely support the vehicle so there is no danger of it falling over.

1. Disconnect the speedometer cable from the front wheel.

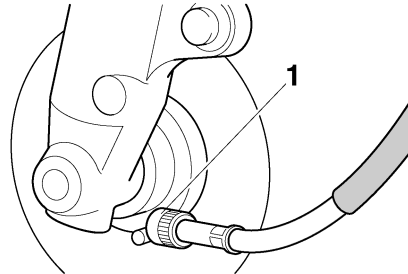

1. Speedometer cable

2. Loosen the front wheel axle pinch bolt, then the wheel axle.

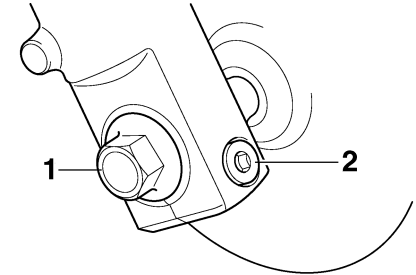

1. Wheel axle
2. Front wheel axle pinch bolt

3. Lift the front wheel off the ground according to the procedure on page 7-33.
4. Pull the wheel axle out, and then remove the wheel. **NOTICE: Do not apply the brake after the wheel has been removed together with the brake disc, otherwise the brake pads will be forced shut.** [ECA11071]

7

EAU24933

### To install the front wheel

1. Install the speedometer gear unit into the wheel hub so that the projections mesh with the slots.

# PERIODIC MAINTENANCE AND ADJUSTMENT

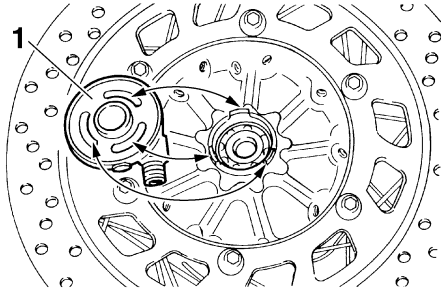

1. Speedometer gear unit

2. Lift the wheel up between the fork legs.

**TIP** \_\_\_\_\_  
Make sure that there is enough space between the brake pads before inserting the brake disc and that the slot in the speedometer gear unit fits over the retainer on the fork leg.

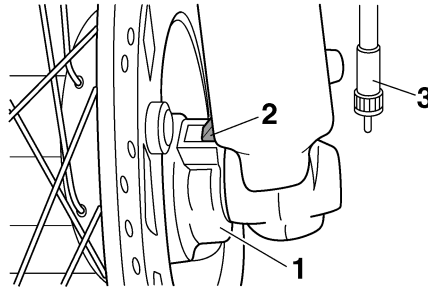

1. Speedometer gear unit

2. Retainer

3. Speedometer cable

3. Insert the wheel axle.
4. Lower the front wheel so that it is on the ground, and then put the sidestand down.
5. Tighten the wheel axle to the specified torque.

## Tightening torque:

Wheel axle:  
59 Nm (5.9 m·kgf, 43 ft·lbf)

6. Tighten the front wheel axle pinch bolt to the specified torque.

## Tightening torque:

Front wheel axle pinch bolt:  
20 Nm (2.0 m·kgf, 14 ft·lbf)

7. While applying the front brake, push down hard on the handlebars several times to check if the front fork compresses and rebounds smoothly.
8. Connect the speedometer cable.

# PERIODIC MAINTENANCE AND ADJUSTMENT

## Rear wheel

EAU25080

### To remove the rear wheel

EAU32751

EWA10821



### WARNING

To avoid injury, securely support the vehicle so there is no danger of it falling over.

1. Remove the axle nut cotter pin.
2. Loosen the chain puller locknut and the drive chain slack adjusting nut on both ends of the swingarm.

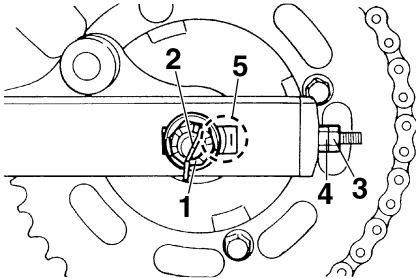

1. Axle nut
2. Axle nut cotter pin
3. Chain puller locknut
4. Drive chain slack adjusting nut
5. Alignment marks

3. Loosen the axle nut and the brake torque rod nut at the brake shoe plate.
4. Lift the rear wheel off the ground according to the procedure on page 7-33.
5. Remove the brake pedal free play adjusting nut, and then disconnect the brake rod at the brake camshaft lever.
6. Disconnect the brake torque rod from the brake shoe plate by removing the nut and the bolt.

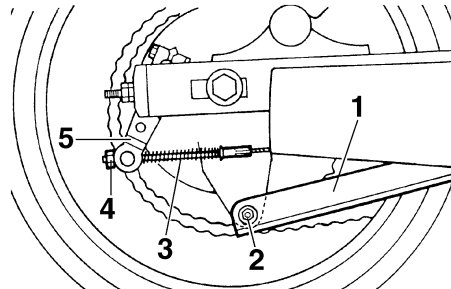

1. Brake torque rod
2. Brake torque rod bolt and nut
3. Brake rod
4. Brake pedal free play adjusting nut
5. Brake camshaft lever

7. Push the wheel forward, and then remove the drive chain from the rear sprocket.

### TIP

The drive chain does not need to be disassembled in order to remove and install the rear wheel.

8. Remove the axle nut.
9. Pull the wheel axle out, and then remove the wheel.

EAU32764

### To install the rear wheel

1. Install the drive chain onto the rear sprocket, and then install the wheel by inserting the wheel axle from the right-hand side.
2. Install the brake rod onto the brake camshaft lever, and then install the brake pedal free play adjusting nut onto the brake rod.
3. Connect the brake torque rod to the brake shoe plate by installing the bolt and nut.
4. Install the axle nut.
5. Lower the rear wheel so that it is on the ground, and then put the sidestand down.

# PERIODIC MAINTENANCE AND ADJUSTMENT

6. Tighten the brake torque rod nut to the specified torque.

## Tightening torque:

Brake torque rod nut:  
23 Nm (2.3 m·kgf, 17 ft·lbf)

7. Adjust the drive chain slack. (See page 7-22.)
8. Tighten the axle nut to the specified torque.

## Tightening torque:

Axle nut:  
104 Nm (10.4 m·kgf, 75 ft·lbf)

9. Insert a new cotter pin into the axle nut, and then bend its ends as shown. **WARNING! Always use a new cotter pin for the axle nut.**

[EWA10701]

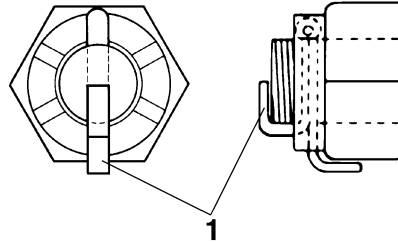

1. Cotter pin

## TIP

Make sure that two notches in the axle nut are aligned with the hole through the wheel axle, otherwise further tighten the axle nut until they are.

10. Adjust the brake pedal free play. (See page 7-19.)

EWA10660

## **WARNING**

**After adjusting the brake pedal free play, check the operation of the brake light.**

## Troubleshooting

EAU25851

Although Yamaha motorcycles receive a thorough inspection before shipment from the factory, trouble may occur during operation. Any problem in the fuel, compression, or ignition systems, for example, can cause poor starting and loss of power.

The following troubleshooting chart represents a quick and easy procedure for checking these vital systems yourself. However, should your motorcycle require any repair, take it to a Yamaha dealer, whose skilled technicians have the necessary tools, experience, and know-how to service the motorcycle properly.

Use only genuine Yamaha replacement parts. Imitation parts may look like Yamaha parts, but they are often inferior, have a shorter service life and can lead to expensive repair bills.

EWA15141

## **WARNING**

**When checking the fuel system, do not smoke, and make sure there are no open flames or sparks in the area, including pilot lights from water**



## **PERIODIC MAINTENANCE AND ADJUSTMENT**

---

---

heaters or furnaces. Gasoline or gasoline vapors can ignite or explode, causing severe injury or property damage.

---

# PERIODIC MAINTENANCE AND ADJUSTMENT

EAU25932

## Troubleshooting chart

### 1. Fuel

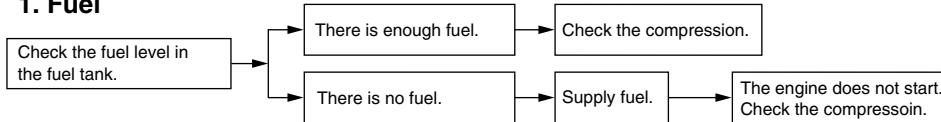

### 2. Compression

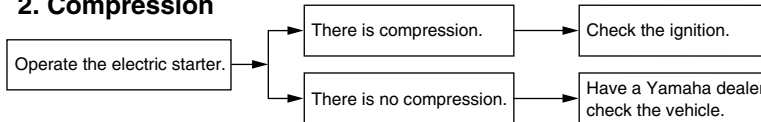

### 3. Ignition

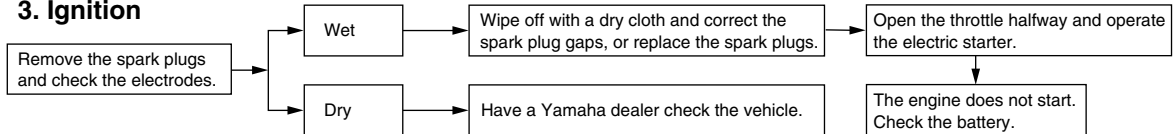

### 4. Battery

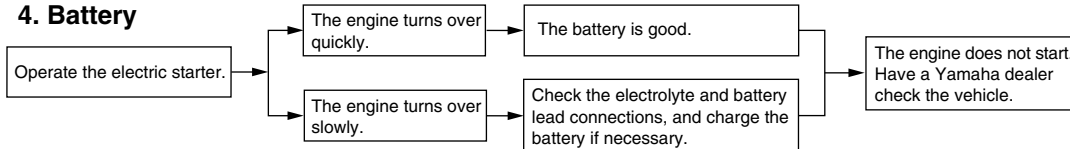

## Matte color caution

EAU37833

EAU26044

### NOTICE

Some models are equipped with matte colored finished parts. Be sure to consult a Yamaha dealer for advice on what products to use before cleaning the vehicle. Using a brush, harsh chemical products or cleaning compounds when cleaning these parts will scratch or damage their surface. Wax also should not be applied to any matte colored finished parts.

ECA15192

## Care

While the open design of a motorcycle reveals the attractiveness of the technology, it also makes it more vulnerable. Rust and corrosion can develop even if high-quality components are used. A rusty exhaust pipe may go unnoticed on a car, however, it detracts from the overall appearance of a motorcycle. Frequent and proper care does not only comply with the terms of the warranty, but it will also keep your motorcycle looking good, extend its life and optimize its performance.

### Before cleaning

1. Cover the muffler outlets with plastic bags after the engine has cooled down.
2. Make sure that all caps and covers as well as all electrical couplers and connectors, including the spark plug caps, are tightly installed.
3. Remove extremely stubborn dirt, like oil burnt onto the crankcase, with a degreasing agent and a brush, but never apply such prod-

ucts onto seals, gaskets, sprockets, the drive chain and wheel axles. Always rinse the dirt and degreaser off with water.

## Cleaning

ECA10772

### NOTICE

- Avoid using strong acidic wheel cleaners, especially on spoked wheels. If such products are used on hard-to-remove dirt, do not leave the cleaner on the affected area any longer than instructed. Also, thoroughly rinse the area off with water, immediately dry it, and then apply a corrosion protection spray.
- Improper cleaning can damage plastic parts (such as cowlings, panels, windshields, headlight lenses, meter lenses, etc.) and the mufflers. Use only a soft, clean cloth or sponge with water to clean plastic. However, if the plastic parts cannot be thoroughly cleaned with water, diluted mild detergent with water may be used. Be sure to rinse

# MOTORCYCLE CARE AND STORAGE

---

off any detergent residue using plenty of water, as it is harmful to plastic parts.

- Do not use any harsh chemical products on plastic parts. Be sure to avoid using cloths or sponges which have been in contact with strong or abrasive cleaning products, solvent or thinner, fuel (gasoline), rust removers or inhibitors, brake fluid, antifreeze or electrolyte.
- Do not use high-pressure washers or steam-jet cleaners since they cause water seepage and deterioration in the following areas: seals (of wheel and swing-arm bearings, fork and brakes), electric components (couplers, connectors, instruments, switches and lights), breather hoses and vents.
- For motorcycles equipped with a windshield: Do not use strong cleaners or hard sponges as they will cause dulling or scratching. Some cleaning compounds for plastic may leave scratches on the windshield.

Test the product on a small hidden part of the windshield to make sure that it does not leave any marks. If the windshield is scratched, use a quality plastic polishing compound after washing.

---

## After normal use

Remove dirt with warm water, a mild detergent, and a soft, clean sponge, and then rinse thoroughly with clean water. Use a toothbrush or bottlebrush for hard-to-reach areas. Stubborn dirt and insects will come off more easily if the area is covered with a wet cloth for a few minutes before cleaning.

## After riding in the rain, near the sea or on salt-sprayed roads

Since sea salt or salt sprayed on roads during winter are extremely corrosive in combination with water, carry out the following steps after each ride in the rain, near the sea or on salt-sprayed roads.

## TIP

---

Salt sprayed on roads in the winter may remain well into spring.

---

1. Clean the motorcycle with cold water and a mild detergent, after the engine has cooled down.  
**NOTICE: Do not use warm water since it increases the corrosive action of the salt.**<sup>[ECA10791]</sup>
2. After drying the motorcycle, apply a corrosion protection spray on all metal, including chrome- and nickel-plated, surfaces to prevent corrosion.

## After cleaning

1. Dry the motorcycle with a chamois or an absorbing cloth.
2. Immediately dry the drive chain and lubricate it to prevent it from rusting.
3. Use a chrome polish to shine chrome, aluminum and stainless-steel parts, including the exhaust system. (Even the thermally induced discoloring of stainless-steel exhaust systems can be removed through polishing.)

# MOTORCYCLE CARE AND STORAGE

4. To prevent corrosion, it is recommended to apply a corrosion protection spray on all metal, including chrome- and nickel-plated, surfaces.
5. Use spray oil as a universal cleaner to remove any remaining dirt.
6. Touch up minor paint damage caused by stones, etc.
7. Wax all painted surfaces.
8. Let the motorcycle dry completely before storing or covering it.

EWA11131

## WARNING

**Contaminants on the brakes or tires can cause loss of control.**

- **Make sure that there is no oil or wax on the brakes or tires.**
- **If necessary, clean the brake discs and brake linings with a regular brake disc cleaner or acetone, and wash the tires with warm water and a mild detergent. Before riding at higher speeds, test the motorcycle's braking performance and cornering behavior.**

ECA10800

## NOTICE

- **Apply spray oil and wax sparingly and make sure to wipe off any excess.**
- **Never apply oil or wax to any rubber and plastic parts, but treat them with a suitable care product.**
- **Avoid using abrasive polishing compounds as they will wear away the paint.**

## TIP

- Consult a Yamaha dealer for advice on what products to use.
- Washing, rainy weather or humid climates can cause the headlight lens to fog. Turning the headlight on for a short period of time will help remove the moisture from the lens.

EAU26212

## Storage

### Short-term

Always store your motorcycle in a cool, dry place and, if necessary, protect it against dust with a porous cover.

ECA10810

## NOTICE

- **Storing the motorcycle in a poorly ventilated room or covering it with a tarp, while it is still wet, will allow water and humidity to seep in and cause rust.**
- **To prevent corrosion, avoid damp cellars, stables (because of the presence of ammonia) and areas where strong chemicals are stored.**

### Long-term

Before storing your motorcycle for several months:

1. Follow all the instructions in the "Care" section of this chapter.
2. Turn the fuel cock lever to "ON".

# MOTORCYCLE CARE AND STORAGE

---

3. Drain the carburetor float chambers by loosening the drain bolts; this will prevent fuel deposits from building up. Pour the drained fuel into the fuel tank.
4. Fill up the fuel tank and add fuel stabilizer (if available) to prevent the fuel tank from rusting and the fuel from deteriorating.
5. Perform the following steps to protect the cylinders, piston rings, etc. from corrosion.
  - a. Remove the spark plug caps and spark plugs.
  - b. Pour a teaspoonful of engine oil into each spark plug bore.
  - c. Install the spark plug caps onto the spark plugs, and then place the spark plugs on the cylinder head so that the electrodes are grounded. (This will limit sparking during the next step.)
  - d. Turn the engine over several times with the starter. (This will coat the cylinder walls with oil.)**WARNING! To prevent damage or injury from sparking, make sure to ground the**

## **spark plug electrodes while turning the engine over.**

[EWA10951]

- e. Remove the spark plug caps from the spark plugs, and then install the spark plugs and the spark plug caps.
6. Lubricate all control cables and the pivoting points of all levers and pedals as well as of the side-stand/centerstand.
7. Check and, if necessary, correct the tire air pressure, and then lift the motorcycle so that both of its wheels are off the ground. Alternatively, turn the wheels a little every month in order to prevent the tires from becoming degraded in one spot.
8. Cover the muffler outlets with plastic bags to prevent moisture from entering them.
9. Remove the battery and fully charge it. Store it in a cool, dry place and charge it once a month. Do not store the battery in an excessively cold or warm place [less than 0 °C (30 °F) or more than 30

°C (90 °F)]. For more information on storing the battery, see page 7-28.

---

### **TIP**

Make any necessary repairs before storing the motorcycle.

---

## Dimensions:

- Overall length:  
2190 mm (86.2 in)
- Overall width:  
815 mm (32.1 in)
- Overall height:  
1140 mm (44.9 in)
- Seat height:  
685 mm (27.0 in)
- Wheelbase:  
1490 mm (58.7 in)
- Ground clearance:  
145 mm (5.71 in)
- Minimum turning radius:  
2800 mm (110.2 in)

## Weight:

- With oil and fuel:  
147.0 kg (324 lb)

## Engine:

- Engine type:  
Air cooled 4-stroke, SOHC
- Cylinder arrangement:  
V-type 2-cylinder
- Displacement:  
249 cm<sup>3</sup>
- Bore × stroke:  
49.0 × 66.0 mm (1.93 × 2.60 in)
- Compression ratio:  
10.00 :1
- Starting system:  
Electric starter
- Lubrication system:  
Wet sump

## Engine oil:

- Recommended brand:  
YAMALUBE
- Type:  
SAE 10W-30, 10W-40, 10W-50, 15W-40,  
20W-40 or 20W-50

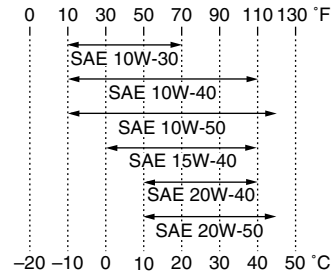

- Recommended engine oil grade:  
API service SG type or higher, JASO  
standard MA
- Engine oil quantity:  
Without oil filter element replacement:  
1.40 L (1.48 US qt, 1.23 Imp.qt)  
With oil filter element replacement:  
1.60 L (1.69 US qt, 1.41 Imp.qt)

## Air filter:

- Air filter element:  
Wet element

## Fuel:

- Recommended fuel:  
Unleaded gasoline only
- Fuel tank capacity:  
9.5 L (2.51 US gal, 2.09 Imp.gal)

- Fuel reserve amount:  
2.6 L (0.69 US gal, 0.57 Imp.gal)

## Carburetor:

- Type × quantity:  
BDS26 x 1

## Spark plug (s):

- Manufacturer/model:  
NGK/C6HSA
- Manufacturer/model:  
DENSO/U20FS-U
- Spark plug gap:  
0.6–0.7 mm (0.024–0.028 in)

## Clutch:

- Clutch type:  
Wet, multiple-disc

## Transmission:

- Primary reduction system:  
Spur gear
- Primary reduction ratio:  
72/23 (3.130)
- Secondary reduction system:  
Chain drive
- Secondary reduction ratio:  
45/16 (2.812)
- Transmission type:  
Constant mesh 5-speed
- Operation:  
Left foot operation
- Gear ratio:  
1st:  
37/14 (2.643)  
2nd:  
32/19 (1.684)

# SPECIFICATIONS

3rd:  
29/23 (1.261)  
4th:  
26/26 (1.000)  
5th:  
23/28 (0.821)

## Chassis:

Frame type:  
Double cradle  
Caster angle:  
32.00 °  
Trail:  
120.0 mm (4.72 in)

## Front tire:

Type:  
With tube  
Size:  
3.00-18 47P  
Manufacturer/model:  
CHENG SHIN/C-916

## Rear tire:

Type:  
With tube  
Size:  
130/90-15M/C 66P  
Manufacturer/model:  
CHENG SHIN/C-915

## Loading:

Maximum load:  
196 kg (432 lb)  
(Total weight of rider, passenger, cargo and accessories)

## Tire air pressure (measured on cold tires):

Loading condition:  
0–90 kg (0–198 lb)  
Front:  
175 kPa (1.75 kgf/cm<sup>2</sup>, 25 psi)  
Rear:  
200 kPa (2.00 kgf/cm<sup>2</sup>, 29 psi)  
Loading condition:  
90–196 kg (198–432 lb)  
Front:  
200 kPa (2.00 kgf/cm<sup>2</sup>, 29 psi)  
Rear:  
225 kPa (2.25 kgf/cm<sup>2</sup>, 33 psi)

## Front wheel:

Wheel type:  
Spoke wheel  
Rim size:  
18x1.60

## Rear wheel:

Wheel type:  
Spoke wheel  
Rim size:  
15M/C x MT2.75

## Front brake:

Type:  
Single disc brake  
Operation:  
Right hand operation  
Recommended fluid:  
DOT 4

## Rear brake:

Type:  
Drum brake

Operation:  
Right foot operation

## Front suspension:

Type:  
Telescopic fork  
Spring/shock absorber type:  
Coil spring/oil damper  
Wheel travel:  
140.0 mm (5.51 in)

## Rear suspension:

Type:  
Swingarm  
Spring/shock absorber type:  
Coil spring/oil damper  
Wheel travel:  
100.0 mm (3.94 in)

## Electrical system:

Ignition system:  
TCI (digital)  
Charging system:  
AC magneto

## Battery:

Model:  
YB10L-A  
Voltage, capacity:  
12 V, 10.0 Ah

## Headlight:

Bulb type:  
Halogen bulb

## Bulb voltage, wattage × quantity:

Headlight:  
12 V, 60 W/55 W × 1  
Tail/brake light:  
12 V, 5.0 W/21.0 W × 1



Front turn signal light:

12 V, 21.0 W × 2

Rear turn signal light:

12 V, 21.0 W × 2

Meter lighting:

14 V, 3.0 W × 1

Neutral indicator light:

14 V, 3.0 W × 1

High beam indicator light:

12 V, 1.7 W × 1

Turn signal indicator light:

14 V, 3.0 W × 1

## **Fuses:**

Main fuse:

20.0 A

Signaling system fuse:

10.0 A

# CONSUMER INFORMATION

EAU26352

## Identification numbers

Record the key identification number, vehicle identification number and model label information in the spaces provided below for assistance when ordering spare parts from a Yamaha dealer or for reference in case the vehicle is stolen.

KEY IDENTIFICATION NUMBER:

VEHICLE IDENTIFICATION NUMBER:

MODEL LABEL INFORMATION:

## Key identification number

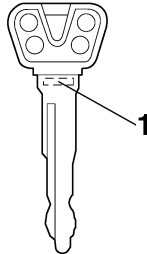

1. Key identification number

The key identification number is stamped into the key. Record this number in the space provided and use it for reference when ordering a new key.

EAU26390

## Vehicle identification number

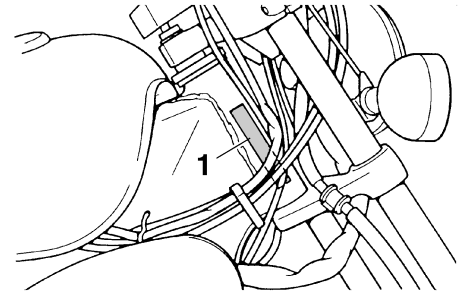

1. Vehicle identification number

The vehicle identification number is stamped into the steering head pipe. Record this number in the space provided.

### TIP \_\_\_\_\_

The vehicle identification number is used to identify your motorcycle and may be used to register your motorcycle with the licensing authority in your area.

\_\_\_\_\_

EAU26400

## Model label

EAU26470

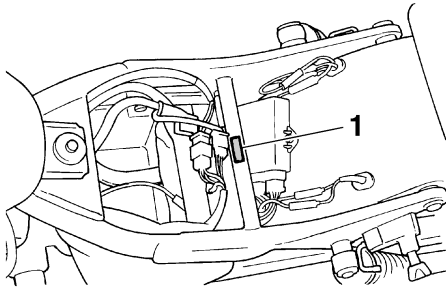

1. Model label

The model label is affixed to the frame under the rider seat. (See page 4-9.) Record the information on this label in the space provided. This information will be needed when ordering spare parts from a Yamaha dealer.

## Motorcycle noise regulation (for Australia)

EAU26570

### TAMPERING WITH NOISE CONTROL SYSTEM PROHIBITED:

Owners are warned that the law may prohibit:

- a. The removal or rendering inoperative by any person other than for purposes of maintenance, repair or replacement, of any device or element of design incorporated into any new vehicle for the purpose of noise control prior to its sale or delivery to the ultimate purchaser or while it is in use; and
- b. The use of the vehicle after such device or element of design has been removed or rendered inoperative by any person.

# INDEX

---

- A**  
Air filter element, cleaning..... 7-11
- B**  
Battery..... 7-28  
Brake and clutch levers,  
checking and lubricating..... 7-26  
Brake and shift pedals,  
checking and lubricating..... 7-25  
Brake fluid, changing..... 7-22  
Brake fluid level, checking..... 7-21  
Brake lever..... 4-4  
Brake lever free play, adjusting..... 7-18  
Brake pads and shoes, checking..... 7-20  
Brake pedal..... 4-5  
Brake pedal position and free play,  
adjusting..... 7-19
- C**  
Cables, checking and lubricating..... 7-24  
Carburetor, adjusting..... 7-13  
Care..... 8-1  
Clutch lever..... 4-4  
Clutch lever free play, adjusting..... 7-17
- D**  
Dimmer switch..... 4-3  
Drive chain, cleaning and lubricating.... 7-24  
Drive chain slack..... 7-22
- E**  
Engine break-in..... 6-3  
Engine idling speed..... 7-13  
Engine oil and oil filter element..... 7-9  
Engine, starting a warm..... 6-2  
Engine stop switch..... 4-3
- F**  
Front fork, checking..... 7-27
- Fuel..... 4-6  
Fuel cock..... 4-7  
Fuel consumption, tips for reducing..... 6-3  
Fuel tank cap..... 4-5  
Fuses, replacing..... 7-30
- H**  
Handlebar switches..... 4-2  
Hazard switch..... 4-3  
Headlight bulb, replacing..... 7-31  
Helmet holder..... 4-9  
High beam indicator light..... 4-2  
Horn switch..... 4-3
- I**  
Identification numbers..... 10-1  
Ignition circuit cut-off system..... 4-11  
Indicator lights..... 4-1
- K**  
Key identification number..... 10-1
- L**  
Labels, location..... 1-1
- M**  
Main switch..... 4-1  
Maintenance and lubrication, periodic.... 7-3  
Maintenance, emission control system... 7-2  
Matte color, caution..... 8-1  
Model label..... 10-2
- N**  
Neutral indicator light..... 4-1  
Noise regulation (for Australia)..... 10-2
- P**  
Panel, removing and installing..... 7-7  
Parking..... 6-4  
Part locations..... 3-1  
Pass switch..... 4-3
- R**  
Rear brake light switch, adjusting..... 7-20  
Rider seat..... 4-9
- S**  
Safety information..... 2-1  
Shifting..... 6-2  
Shift pedal..... 4-4  
Shock absorber assemblies,  
adjusting..... 4-10  
Sidestand..... 4-10  
Sidestand, checking and lubricating..... 7-26  
Spark plugs, checking..... 7-7  
Specifications..... 9-1  
Speedometer unit..... 4-2  
Starter (choke) lever..... 4-8  
Starting and warming up a cold engine... 6-1  
Start switch..... 4-3  
Steering, checking..... 7-28  
Steering lock..... 4-8  
Storage..... 8-3  
Supporting the motorcycle..... 7-33  
Swingarm pivots, lubricating..... 7-27
- T**  
Tail/brake light bulb, replacing..... 7-32  
Throttle cable free play, checking..... 7-14  
Throttle grip and cable,  
checking and lubricating..... 7-25  
Tires..... 7-15  
Tool kit..... 7-1  
Troubleshooting..... 7-37  
Troubleshooting chart..... 7-39  
Turn signal indicator light..... 4-1  
Turn signal light bulb, replacing..... 7-33  
Turn signal switch..... 4-3

## V

- Valve clearance ..... 7-14
- Vehicle identification number ..... 10-1

## W

- Wheel bearings, checking ..... 7-28
- Wheel (front) ..... 7-34
- Wheel (rear) ..... 7-36
- Wheels ..... 7-16







PRINTED ON RECYCLED PAPER

PRINTED IN JAPAN  
2009.05-0.3×1 CR  
(E)