

⚠ Read this manual carefully before operating this vehicle.

⚠ Il convient de lire attentivement ce manuel avant la première utilisation du véhicule.

⚠ Bitte lesen Sie diese Bedienungsanleitung sorgfältig durch, bevor Sie das Fahrzeug in Betrieb nehmen.

**OWNER'S SERVICE MANUAL
MANUEL D'ATELIER DU
PROPRIETAIRE
FAHRER- UND
WARTUNGSHANDBUCH**

YZ450F(B)

 **Read this manual carefully before operating this vehicle. This manual should stay with this vehicle if it is sold.**

 **Il convient de lire attentivement ce manuel avant la première utilisation du véhicule. Le manuel doit être remis avec le véhicule en cas de vente de ce dernier.**

 **Bitte lesen Sie diese Bedienungsanleitung sorgfältig durch, bevor Sie das Fahrzeug in Betrieb nehmen. Diese Bedienungsanleitung muss, wenn das Fahrzeug verkauft wird, beim Fahrzeug verbleiben.**



YAMAHA

2012

⚠ Read this manual carefully before operating this vehicle.

OWNER'S SERVICE MANUAL

YZ450F(B)

33D-28199-82-E0

 **Read this manual carefully before operating this vehicle. This manual should stay with this vehicle if it is sold.**

YZ450F(B)

OWNER'S SERVICE MANUAL

©2011 by Yamaha Motor Co., Ltd.

1st Edition, April 2011

**All rights reserved. Any reprinting or
unauthorized use without the written
permission of Yamaha Motor Co., Ltd.
is expressly prohibited.**

Printed in Japan

FOREWORD

INTRODUCTION

Congratulations on your purchase of a Yamaha YZ series. This model is the culmination of Yamaha's vast experience in the production of pacesetter racing machines. It represents the highest grade of craftsmanship and reliability that have made Yamaha a leader.

This manual explains operation, inspection, basic maintenance and tuning of your machine. If you have any questions about this manual or your machine, please contact your Yamaha dealer.

TIP

Yamaha continually seeks advancements in product design and quality. Therefore, while this manual contains the most current product information available at the time of printing, there may be minor discrepancies between your machine and this manual. If you have any questions concerning this manual, please consult your Yamaha dealer.

WARNING

PLEASE READ THIS MANUAL CAREFULLY AND COMPLETELY BEFORE OPERATING THIS MACHINE. DO NOT ATTEMPT TO OPERATE THIS MACHINE UNTIL YOU HAVE ATTAINED A SATISFACTORY KNOWLEDGE OF ITS CONTROLS AND OPERATING FEATURES AND UNTIL YOU HAVE BEEN TRAINED IN SAFE AND PROPER RIDING TECHNIQUES. REGULAR INSPECTIONS AND CAREFUL MAINTENANCE, ALONG WITH GOOD RIDING SKILLS, WILL ENSURE THAT YOU SAFELY ENJOY THE CAPABILITIES AND THE RELIABILITY OF THIS MACHINE.

IMPORTANT MANUAL INFORMATION

Particularly important information is distinguished in this manual by the following notations.



This is the safety alert symbol. It is used to alert you to potential personal injury hazards. Obey all safety messages that follow this symbol to avoid possible injury or death.

WARNING

A WARNING indicates a hazardous situation which, if not avoided, could result in death or serious injury.

NOTICE

A NOTICE indicates special precautions that must be taken to avoid damage to the vehicle or other property.

TIP

A TIP provides key information to make procedures easier or clearer.

SAFETY INFORMATION

THIS MACHINE IS DESIGNED STRICTLY FOR COMPETITION USE, ONLY ON A CLOSED COURSE. It is illegal for this machine to be operated on any public street, road, or highway. Off-road use on public lands may also be illegal. Please check local regulations before riding.

- THIS MACHINE IS TO BE OPERATED BY AN EXPERIENCED RIDER ONLY.

Do not attempt to operate this machine at maximum power until you are totally familiar with its characteristics.

- THIS MACHINE IS DESIGNED TO BE RIDDEN BY THE OPERATOR ONLY.

Do not carry passengers on this machine.

- ALWAYS WEAR PROTECTIVE APPAREL.

When operating this machine, always wear an approved helmet with goggles or a face shield. Also wear heavy boots, gloves, and protective clothing. Always wear proper fitting clothing that will not be caught in any of the moving parts or controls of the machine.

- ALWAYS MAINTAIN YOUR MACHINE IN PROPER WORKING ORDER.

For safety and reliability, the machine must be properly maintained. Always perform the pre-operation checks indicated in this manual. Correcting a mechanical problem before you ride may prevent an accident.

- GASOLINE IS HIGHLY FLAMMABLE.

Always turn off the engine while refueling. Take care to not spill any gasoline on the engine or exhaust system. Never refuel in the vicinity of an open flame, or while smoking.

- GASOLINE CAN CAUSE INJURY. If you should swallow some gasoline, inhale excess gasoline vapors, or allow any gasoline to get into your eyes, contact a doctor immediately. If any gasoline spills onto your skin or clothing, immediately wash skin areas with soap and water, and change your clothes.

- ONLY OPERATE THE MACHINE IN AN AREA WITH ADEQUATE VENTILATION.

Never start the engine or let it run for any length of time in an enclosed area. Exhaust fumes are poisonous. These fumes contain carbon monoxide, which by itself is odorless and colorless. Carbon monoxide is a dangerous gas which can cause unconsciousness or can be lethal.

- PARK THE MACHINE CAREFULLY; TURN OFF THE ENGINE.

Always turn off the engine if you are going to leave the machine. Do not park the machine on a slope or soft ground as it may fall over.

- THE ENGINE, EXHAUST PIPE, MUFFLER, AND OIL TANK WILL BE VERY HOT AFTER THE ENGINE HAS BEEN RUN.

Be careful not to touch them or to allow any clothing item to contact them during inspection or repair.

- PROPERLY SECURE THE MACHINE BEFORE TRANSPORTING IT.

For safety, drain the gasoline from the fuel tank before transporting the vehicle.

HOW TO USE THIS MANUAL

FINDING THE REQUIRED PAGE

1. This manual consists of eight chapters; "General Information", "Specifications", "Regular inspection and adjustments", "Engine", "Chassis", "Fuel system", "Electrical" and "Tuning".
2. The table of contents is at the beginning of the manual. Look over the general layout of the book before finding then required chapter and item.

Bend the book at its edge, as shown, to find the required fore edge symbol mark and go to a page for required item and description.

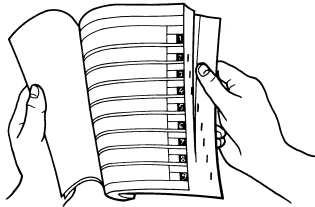

MANUAL FORMAT

All of the procedures in this manual are organized in a sequential, step-by-step format. The information has been compiled to provide the mechanic with an easy to read, handy reference that contains comprehensive explanations of all disassembly, repair, assembly, and inspection operations.

In this revised format, the condition of a faulty component will precede an arrow symbol and the course of action required will follow the symbol, e.g.,

- Bearings
Pitting/damage → Replace.

HOW TO READ DESCRIPTIONS

To help identify parts and clarify procedure steps, there are exploded diagrams at the start of each removal and disassembly section.

1. An easy-to-see exploded diagram "1" is provided for removal and disassembly jobs.

2. Numbers "2" are given in the order of the jobs in the exploded diagram. A number that is enclosed by a circle indicates a disassembly step.
3. An explanation of jobs and notes is presented in an easy-to-read way by the use of symbol marks "3". The meanings of the symbol marks are given on the next page.

4. A job instruction chart "4" accompanies the exploded diagram, providing the order of jobs, names of parts, notes in jobs, etc.
5. For jobs requiring more information, the step-by-step format supplements "5" are given in addition to the exploded diagram and job instruction chart.

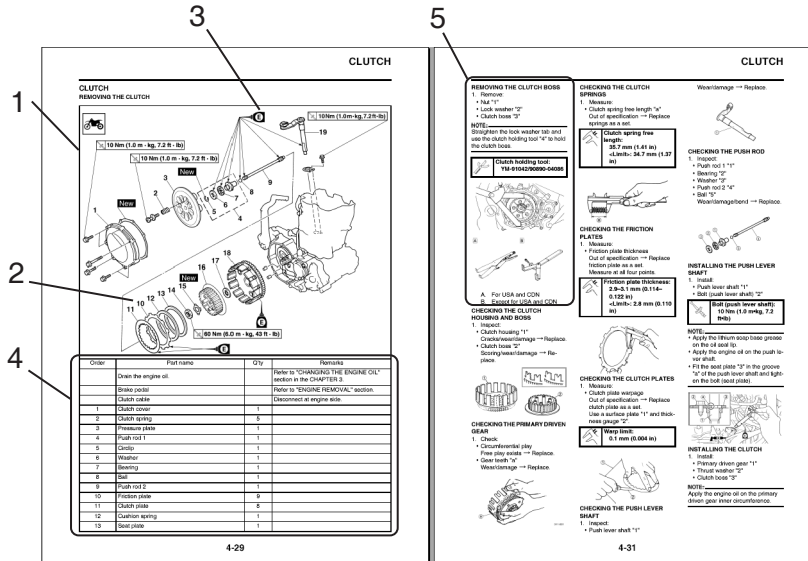

ILLUSTRATED SYMBOLS (Refer to the illustration)

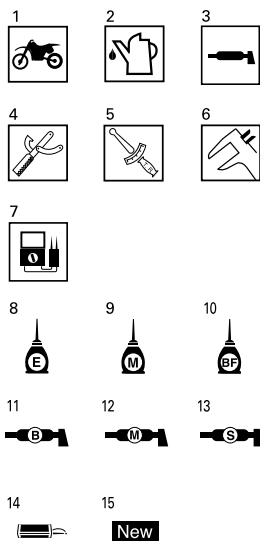

Illustrated symbols "1" to "7" are used to identify the specifications appearing in the text.

- With engine mounted
- Filling fluid
- Lubricant
- Special tool
- Tightening
- Specified value, Service limit
- Resistance (Ω), Voltage (V), Electric current (A)

Illustrated symbols "8" to "13" in the exploded diagrams indicate grade of lubricant and location of lubrication point.

- Apply engine oil
- Apply molybdenum disulfide oil
- Apply brake fluid
- Apply lightweight lithium-soap base grease
- Apply molybdenum disulfide grease

- Apply silicone grease
- Apply locking agent (LOCTITE®)
- Use new one

TABLE OF CONTENTS

GENERAL INFORMATION

1

SPECIFICATIONS

2

**REGULAR INSPECTION AND
ADJUSTMENTS**

3

ENGINE

4

CHASSIS

5

FUEL SYSTEM

6

ELECTRICAL

7

TUNING

8

CONTENTS

CHAPTER 1 GENERAL INFORMATION

LOCATION OF IMPORTANT LABELS	1-1
DESCRIPTION	1-5
CONSUMER INFORMATION.....	1-6
FEATURES.....	1-7
INCLUDED PARTS	1-9
IMPORTANT INFORMATION.....	1-9
HANDLING THE ELECTRONIC PARTS ...	1-10
CHECKING OF CONNECTION.....	1-10
SPECIAL TOOLS.....	1-12
CONTROL FUNCTIONS.....	1-17
STARTING AND BREAK-IN.....	1-17
TORQUE-CHECK POINTS.....	1-19
CLEANING AND STORAGE	1-20

CHAPTER 2 SPECIFICATIONS

GENERAL SPECIFICATIONS.....	2-1
MAINTENANCE SPECIFICATIONS.....	2-3
TIGHTENING TORQUES	2-11
LUBRICATION DIAGRAMS	2-17
CABLE ROUTING DIAGRAM.....	2-18

CHAPTER 3 REGULAR INSPECTION AND ADJUSTMENTS

MAINTENANCE INTERVALS.....	3-1
PRE-OPERATION INSPECTION AND MAINTENANCE.....	3-5
ENGINE	3-6
CHASSIS	3-14
ELECTRICAL	3-24

CHAPTER 4 ENGINE

SEAT AND SIDE COVERS.....	4-1
EXHAUST PIPE AND SILENCER	4-3
RADIATOR	4-5
CAMSHAFTS.....	4-8
CYLINDER HEAD.....	4-13
VALVES AND VALVE SPRINGS	4-17
CYLINDER AND PISTON	4-21
CLUTCH	4-25
OIL FILTER ELEMENT AND WATER PUMP.....	4-29
BALANCER.....	4-33
OIL PUMP	4-35
KICK SHAFT AND SHIFT SHAFT	4-38
AC MAGNETO.....	4-43
ENGINE REMOVAL	4-45
CRANKCASE AND CRANKSHAFT	4-50
TRANSMISSION, SHIFT CAM AND SHIFT FORK.....	4-56

CHAPTER 5 CHASSIS

FRONT WHEEL AND REAR WHEEL	5-1
FRONT BRAKE AND REAR BRAKE.....	5-6
FRONT FORK.....	5-16
HANDLEBAR.....	5-24
STEERING	5-28
SWINGARM	5-32
REAR SHOCK ABSORBER.....	5-37

CHAPTER 6 FUEL SYSTEM

FUEL TANK	6-1
THROTTLE BODY	6-4

CHAPTER 7 ELECTRICAL

ELECTRICAL COMPONENTS AND WIRING DIAGRAM.....	7-1
IGNITION SYSTEM.....	7-3
THROTTLE POSITION SENSOR SYSTEM	7-6
FUEL INJECTION SYSTEM.....	7-9
FUEL PUMP SYSTEM....	7-35
ELECTRICAL COMPONENTS.....	7-36

CHAPTER 8 TUNING

CHASSIS	8-1
---------------	-----

LOCATION OF IMPORTANT LABELS

GENERAL INFORMATION

LOCATION OF IMPORTANT LABELS

Please read the following important labels carefully before operating this vehicle.

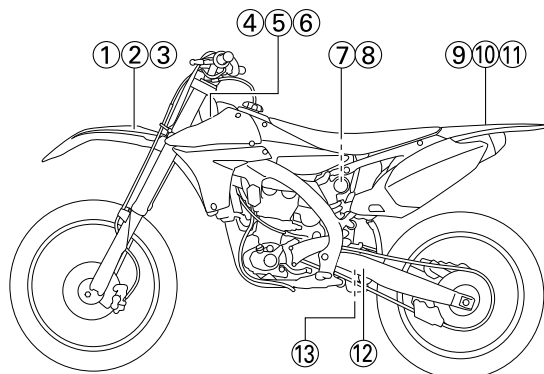

CANADA

1

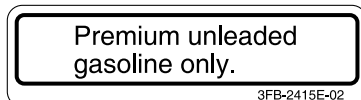

2

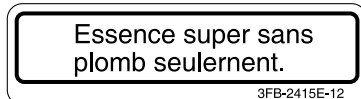

3

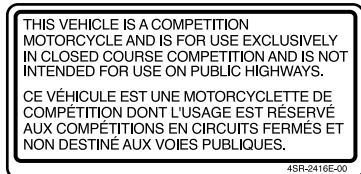

4

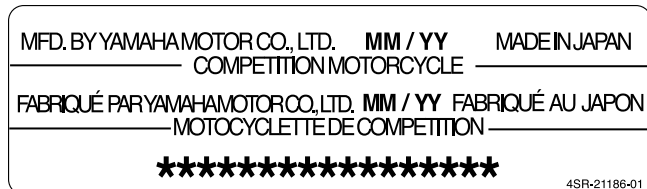

5

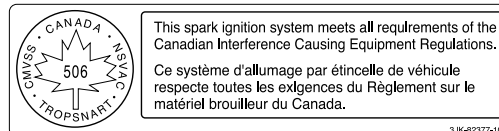

7

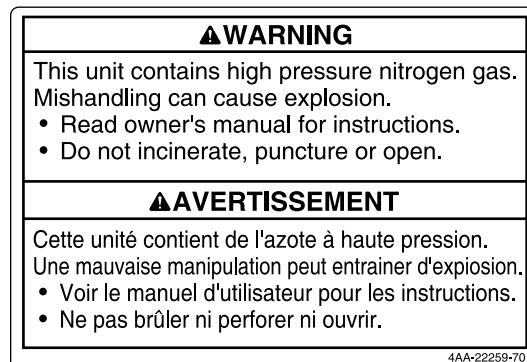

LOCATION OF IMPORTANT LABELS

9

⚠ WARNING

- BEFORE YOU OPERATE THIS VEHICLE, READ THE OWNER'S MANUAL AND ALL LABELS.
- NEVER CARRY A PASSENGER. You increase your risk of losing control if you carry a passenger.
- NEVER OPERATE THIS VEHICLE ON PUBLIC ROADS. You can collide with another vehicle if you operate this vehicle on a public road.
- ALWAYS WEAR AN APPROVED MOTORCYCLE HELMET, eye protection, and protective clothing.
- EXPERIENCED RIDER ONLY.

5PA-2118K-00

12

TIRE INFORMATION

Cold tire normal pressure should be set as follows:

FRONT: 100kPa, {1.00kgf/cm²}, 15psi
 REAR : 100kPa, {1.00kgf/cm²}, 15psi

3RV-21668-A0

10

⚠ AVERTISSEMENT

- LIRE LE MANUEL DU PROPRIETAIRE AINSI QUE TOUTES LES ETIQUETTES AVANT D'UTILISER CE VEHICULE.
- NE JAMAIS TRANSPORTER DE PASSAGER. La conduite avec passager augmente les risques de perte de contrôle.
- NE JAMAIS ROULER SUR DES CHEMINS PUBLICS. Vous pourriez entrer en collision avec un autre véhicule.
- TOUJOURS PORTER UN CASQUE DE MOTOCYCLISTE APPROUVE, des lunettes et des vêtements de protection.
- EXCLUSIVEMENT POUR L'USAGE D'UN CONDUCTEUR EXPERIMENTE.

5PA-2118K-10

13

INFORMATION SUR LES PNEUS

La pression des pneus à froid doit normalement être réglée comme suit.

AVANT : 100kPa, {1.00kgf/cm²}, 15psi
 ARRIERE : 100kPa, {1.00kgf/cm²}, 15psi

3RV-21668-B0

EUROPE

6

CE

YAMAHA MOTOR CO., LTD.
SHIZUOKA JAPAN

YAMAHA 4GB-2155A-00

11

⚠

i **Ⓢ** **⚠** **🏍**

100 kPa 100 kPa
 1.00 kgf/cm² 1.00 kgf/cm²
 15 psi 15 psi

5PG-2816R-00

8



LOCATION OF IMPORTANT LABELS

AUS, NZ, ZA

8



12

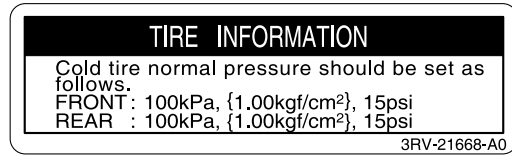







9



LOCATION OF IMPORTANT LABELS

Familiarize yourself with the following pictograms and read the explanatory text.

	Read Owner's service manual.
	This unit contains high-pressure nitrogen gas. Mishandling can cause explosion. Do not incinerate, puncture or open.
	Turn off the main switch after riding to avoid draining the battery.
	Use unleaded gasoline only.
	Measure tire pressure when tires are cold.
 *** kPa *** kPa *.* kgf/cm ² *.* kgf/cm ² ** psi ** psi	Adjust tire pressure. Improper tire pressure can cause loss of control. Loss of control can result in severe injury or death.

DESCRIPTION

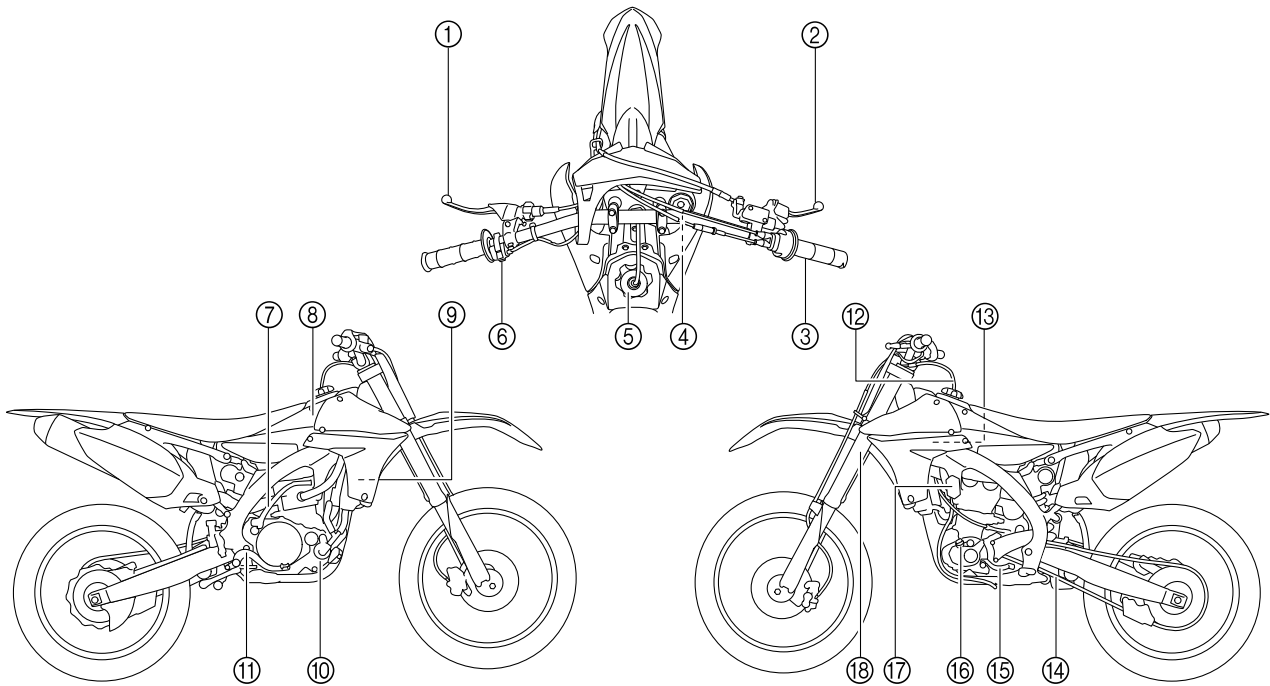

- | | |
|-----------------------|-----------------------------|
| 1. Clutch lever | 10. Coolant drain bolt |
| 2. Front brake lever | 11. Rear brake pedal |
| 3. Throttle grip | 12. Valve joint |
| 4. Radiator cap | 13. Air cleaner |
| 5. Fuel tank cap | 14. Drive chain |
| 6. Engine stop switch | 15. Shift pedal |
| 7. Kickstarter crank | 16. Oil level check window |
| 8. Fuel tank | 17. Starter knob/idle screw |
| 9. Radiator | 18. Front fork |

TIP

-
- The machine you have purchased may differ slightly from those shown in the following.
 - Designs and specifications are subject to change without notice.
-

CONSUMER INFORMATION

There are two significant reasons for knowing the serial number of your machine:

1. When ordering parts, you can give the number to your Yamaha dealer for positive identification of the model you own.
2. If your machine is stolen, the authorities will need the number to search for and identify your machine.

VEHICLE IDENTIFICATION NUMBER

The vehicle identification number "1" is stamped on the right of the steering head pipe.

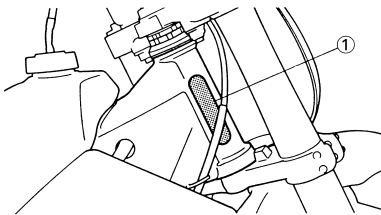

ENGINE SERIAL NUMBER

The engine serial number "1" is stamped into the elevated part of the right-side of the engine.

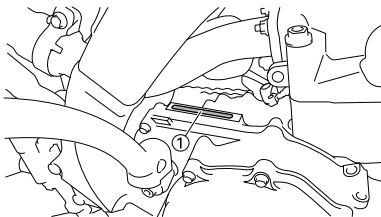

MODEL LABEL

The model label "1" is affixed to the frame under the rider's seat. This information will be needed to order spare parts.

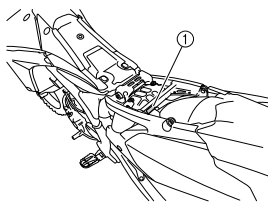

FEATURES

OUTLINE OF THE FI SYSTEM

The main function of a fuel supply system is to provide fuel to the combustion chamber at the optimum air-fuel ratio in accordance with the engine operating conditions and the atmospheric temperature. In the conventional carburetor system, the air-fuel ratio of the mixture that is supplied to the combustion chamber is created by the volume of the intake air and the fuel that is metered by the jet used in the respective carburetor.

Despite the same volume of intake air, the fuel volume requirement varies by the engine operating conditions, such as acceleration, deceleration, or operating under a heavy load. Carburetors that meter the fuel through the use of jets have been provided with various auxiliary devices, so that an optimum air-fuel ratio can be achieved to accommodate the constant changes in the operating conditions of the engine.

This model has adopted an electronically controlled fuel injection (FI) system, in place of the conventional carburetor system. This system can achieve an optimum air-fuel ratio required by the engine at all times by using a microprocessor that regulates the fuel injection volume according to the engine operating conditions detected by various sensors.

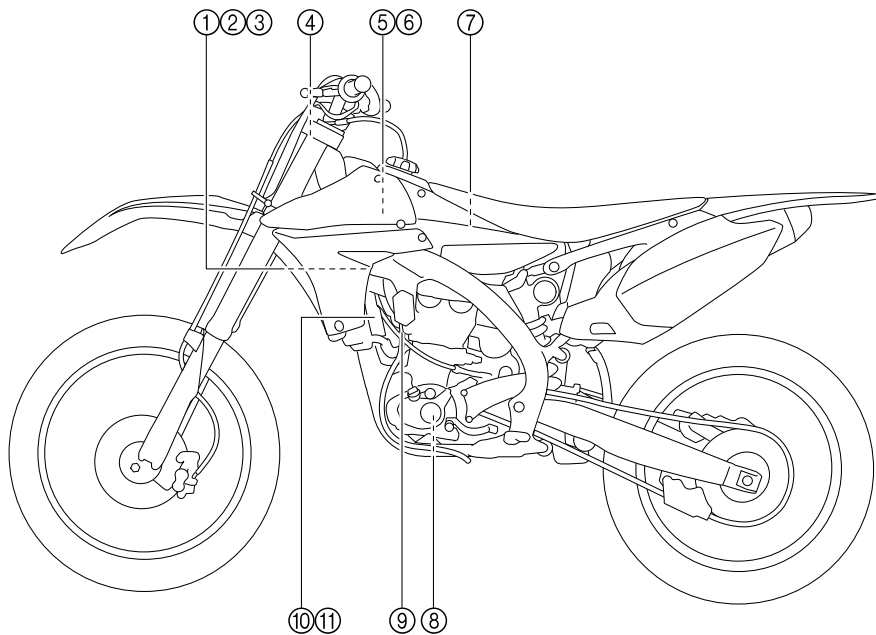

- | | |
|----------------------------------|--------------------------------|
| 1. Fuel injector | 7. Atmospheric pressure sensor |
| 2. Throttle position sensor | 8. Crankshaft position sensor |
| 3. Intake air pressure sensor | 9. Coolant temperature sensor |
| 4. ECU | 10. Ignition coil |
| 5. Fuel pump | 11. Condenser |
| 6. Intake air temperature sensor | |

FI SYSTEM

The fuel pump delivers fuel to the fuel injector via the fuel filter. The pressure regulator maintains the fuel pressure that is applied to the fuel injector at only 324 kPa (3.24 kgf/cm², 47.0 psi). Accordingly, when the energizing signal from the ECU energizes the fuel injector, the fuel passage opens, causing the fuel to be injected into the intake manifold only during the time the passage remains open. Therefore, the longer the length of time the fuel injector is energized (injection duration), the greater the volume of fuel that is supplied. Conversely, the shorter the length of time the fuel injector is energized (injection duration), the lesser the volume of fuel that is supplied.

The injection duration and the injection timing are controlled by the ECU. Signals that are input from the throttle position sensor, coolant temperature sensor, atmospheric pressure sensor, lean angle sensor, crankshaft position sensor, intake air pressure sensor and intake air temperature sensor enable the ECU to determine the injection duration. The injection timing is determined through the signals from the crankshaft position sensor. As a result, the volume of fuel that is required by the engine can be supplied at all times in accordance with the driving conditions.

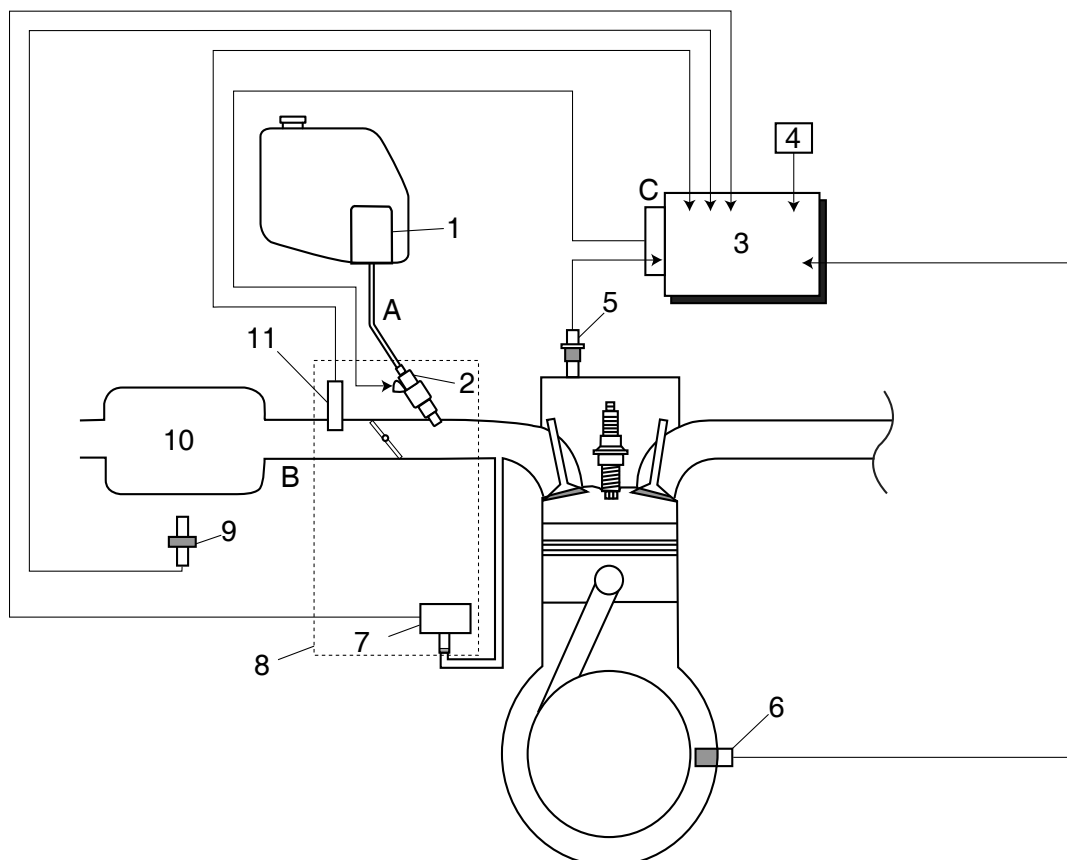

- | | |
|----------------------------------|---------------------------------|
| 1. Fuel pump | 11. Atmospheric pressure sensor |
| 2. Fuel injector | |
| 3. ECU | |
| 4. Throttle position sensor | A. Fuel system |
| 5. Coolant temperature sensor | B. Intake system |
| 6. Crankshaft position sensor | C. Control system |
| 7. Intake air pressure sensor | |
| 8. Throttle body | |
| 9. Intake air temperature sensor | |
| 10. Air filter case | |

INCLUDED PARTS

DETACHABLE SIDESTAND

This sidestand "1" is used to support only the machine when standing or transporting it.

⚠ WARNING

- Never apply additional force to the sidestand.
- Remove this sidestand before starting out.

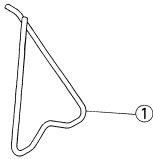

VALVE JOINT

This valve joint "1" prevents fuel from flowing out and is installed to the fuel tank breather hose.

NOTICE

In this installation, make sure the arrow faces the fuel tank and also downward.

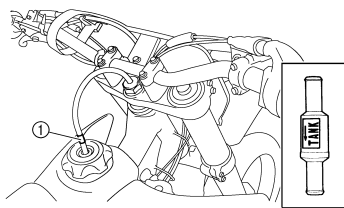

SPARK PLUG WRENCH

This spark plug wrench "1" is used to remove and install the spark plug.

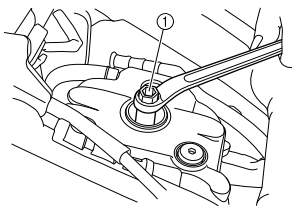

NIPPLE WRENCH

This nipple wrench "1" is used to tighten the spoke.

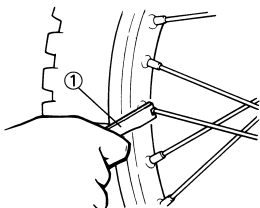

HANDLEBAR PROTECTOR

Install the handlebar protector "1" so that the mark "a" face forward.

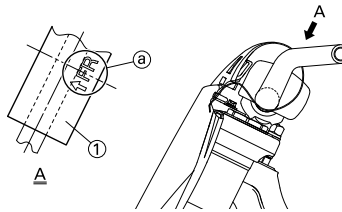

FUEL TANK HOLDING CABLE

The fuel tank holding cable "1" is used to support the fuel tank during maintenance.

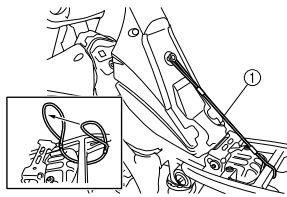

FUEL HOSE JOINT COVER

The fuel hose joint covers "1" are used to prevent mud, dust, and other foreign material from entering the fuel pump when the fuel hose is disconnected.

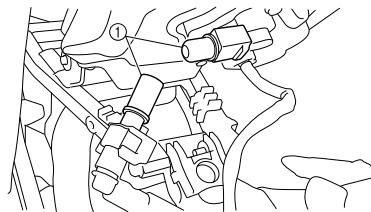

COUPLER FOR CONNECTING OPTIONAL PART

This coupler "1" is used for connection to an optional Power Tuner and so on.

NOTICE

When no optional parts, etc. are connected, connect the connection terminal to the original coupler "2".

Before removing the coupler, thoroughly wipe off any mud or water stuck to it.

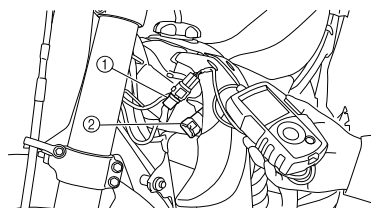

Part name	Part number
YZ Power Tuner	33D-859C0-10

The YZ Power Tuner is optional.

IMPORTANT INFORMATION

PREPARATION FOR REMOVAL AND DISASSEMBLY

1. Remove all dirt, mud, dust, and foreign material before removal and disassembly.
 - When washing the machine with high pressured water, cover the parts follows.
 - Air duct
 - Silencer exhaust port
 - Drain hole on the cylinder head (right side)
 - Water pump housing hole at the bottom

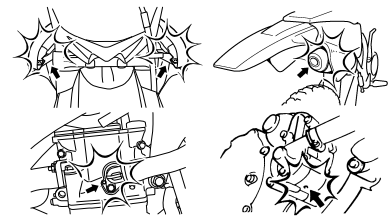
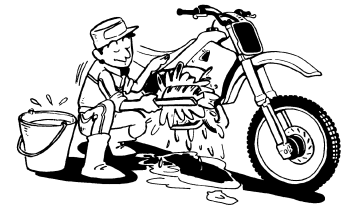

2. Use proper tools and cleaning equipment. Refer to "SPECIAL TOOLS" section.

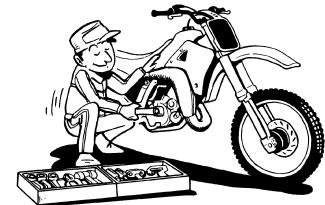

3. When disassembling the machine, keep mated parts together. They include gears, cylinders, pistons, and other mated parts that have been "mated" through normal wear. Mated parts must be reused as an assembly or replaced.



HANDLING THE ELECTRONIC PARTS

- During the machine disassembly, clean all parts and place them in trays in the order of disassembly. This will speed up assembly time and help assure that all parts are correctly reinstalled.



- Keep away from fire.

ALL REPLACEMENT PARTS

- We recommend to use Yamaha genuine parts for all replacements. Use oil and/or grease recommended by Yamaha for assembly and adjustment.

GASKETS, OIL SEALS AND O-RINGS

- All gaskets, oil seals, and O-rings should be replaced when an engine is overhauled. All gasket surfaces, oil seal lips, and O-rings must be cleaned.
- Properly oil all mating parts and bearings during reassembly. Apply grease to the oil seal lips.

LOCK WASHERS/PLATES AND COTTER PINS

- All lock washers/plates "1" and cotter pins must be replaced when they are removed. Lock tab(s) should be bent along the bolt or nut flat(s) after the bolt or nut has been properly tightened.

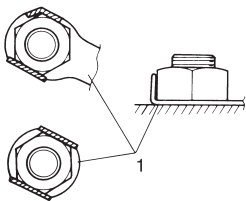

BEARINGS AND OIL SEALS

- Install the bearing(s) "1" and oil seal(s) "2" with their manufacturer's marks or numbers facing outward. (In other words, the stamped letters must be on the side exposed to view.) When installing oil seal(s), apply a light coating of lightweight lithium base grease to the seal lip(s). Oil the bearings liberally when installing.

NOTICE

Do not use compressed air to spin the bearings dry. This causes damage to the bearing surfaces.

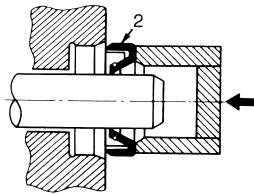
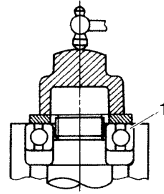

CIRCLIPS

- All circlips should be inspected carefully before reassembly. Always replace piston pin clips after one use. Replace distorted circlips. When installing a circlip "1", make sure that the sharp-edged corner "2" is positioned opposite to the thrust "3" it receives. See the sectional view.

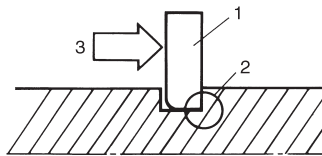

HANDLING THE ELECTRONIC PARTS

NOTICE

Electronic parts are very sensitive. Handle with care and do not give impact.

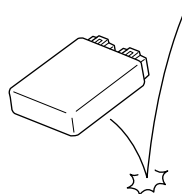

NOTICE

- Mankind has static electricity. It's voltage is very high and electronic parts are very sensitive.
- It is possible that inner small components of electronic parts are destroyed by static electricity.
- Do not touch and do not make them dirty.

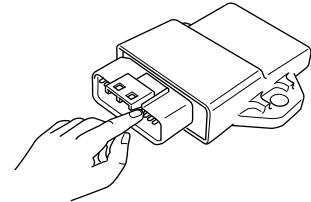

CHECKING OF CONNECTION

Check the leads, couplers, and connectors for stains, rust, moisture, etc.

- Disconnect:
 - Lead
 - Coupler
 - Connector
- Check:
 - Lead
 - Coupler
 - Connector

Moisture → Dry with an air blower.
Rust/stains → Connect and disconnect several times.



- Check:
 - All connections

Loose connection → Connect properly.

TIP

If the pin "1" on the terminal is flattened, bend it up.

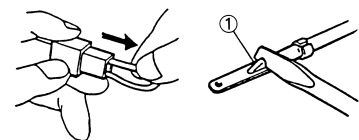

CHECKING OF CONNECTION

TIP

If the contact seems not good, pull the terminal by hand and check its condition.

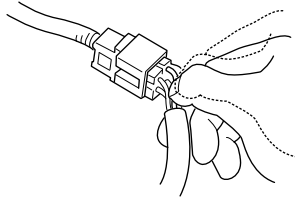

4. Connect:

- Lead
- Coupler
- Connector

TIP

Make sure all connections are tight.

5. Check:

- Continuity
(with the pocket tester)

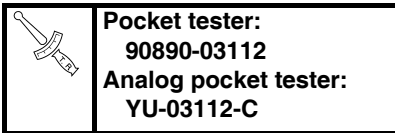

TIP

- If there is no continuity, clean the terminals.
- When checking the wire harness, perform steps (1) to (5).
- As a quick remedy, use a contact revitalizer available at most part stores.

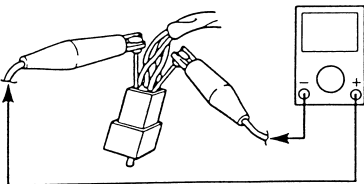
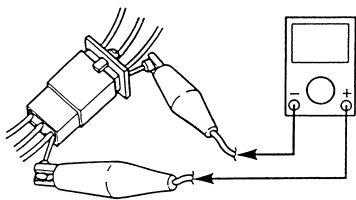

TIP

When you check the voltage or electrical continuity, insert the measuring probe from back side as you can insert from back side.

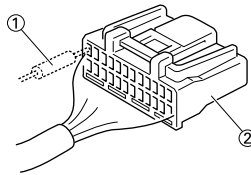

1. Probe
2. Coupler

REMOVING THE QUICK FASTENER

NOTICE

Do not push the center pin with too much force. Otherwise, the center pin could be damaged.

TIP

To remove a quick fastener, push the center pin in with a screwdriver, then pull the fastener out.

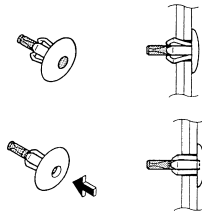

INSTALLING THE QUICK FASTENER

TIP

To install a quick fastener, push its center pin "a" back so that it protrudes from the fastener head, then insert the fastener and push the protruding pin in until it is flush with the fastener head.

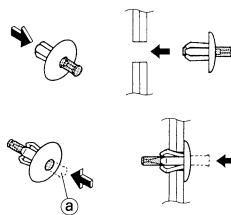

SPECIAL TOOLS

SPECIAL TOOLS

The proper special tools are necessary for complete and accurate tune-up and assembly. Using the correct special tool will help prevent damage caused by the use of improper tools or improvised techniques. The shape and part number used for the special tool differ by country, so two types are provided. Refer to the list provided to avoid errors when placing an order.

TIP

- For U.S.A. and Canada, use part number starting with "YM-", "YU-" or "ACC-".
- For others, use part number starting with "90890-".

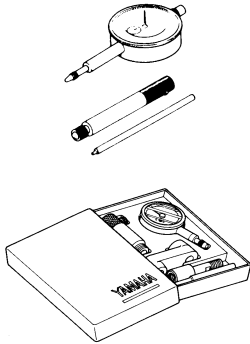
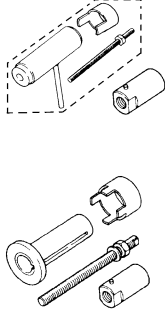
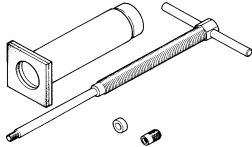
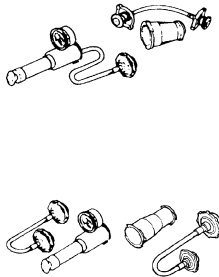
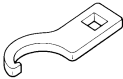
Tool name/Part number	How to use	Illustration
Dial gauge and stand YU-3097, 90890-01252 Stand YU-1256	These tools are used to check each part for runout or bend.	
Crankshaft installing tool Crankshaft installing pot YU-90050, 90890-01274 Crankshaft installing bolt YU-90050, 90890-01275 Spacer (crankshaft installer) YM-91044, 90890-04081 Adapter (M12) YU-90063, 90890-01278	These tools are used to install the crankshaft.	
Piston pin puller set YU-1304, 90890-01304	This tool is used to remove the piston pin.	
Radiator cap tester YU-24460-01, 90890-01325 Radiator cap tester adapter YU-33984, 90890-01352	These tools are used for checking the cooling system.	
Steering nut wrench YU-33975, 90890-01403	This tool is used when tighten the steering ring nut to specification.	

SPECIAL TOOLS

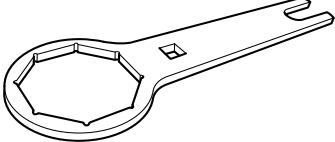
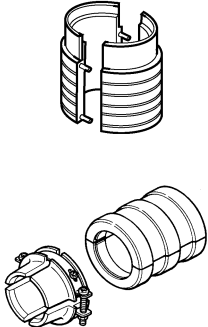
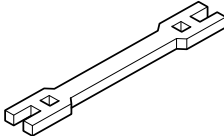
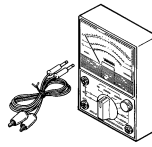
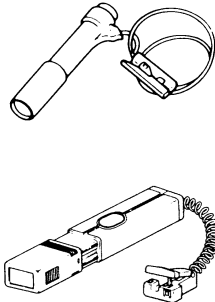
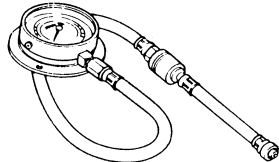
Tool name/Part number	How to use	Illustration
Cap bolt wrench YM-01500, 90890-01500	This tool is used to loosen or tighten the base valve.	
Cap bolt ring wrench YM-01501, 90890-01501	This tool is used to loosen or tighten the damper assembly.	
Fork seal driver YM-A0948, 90890-01502	This tool is used when install the fork oil seal.	
Spoke nipple wrench YM-01521, 90890-01521	This tool is used to tighten the spoke.	
Pocket tester YU-03112-C, 90890-03112	Use this tool to inspect the coil resistance, output voltage and amperage.	
Timing light YM-33277-A, 90890-03141	This tool is necessary for checking ignition timing.	
Pressure gauge YU-03153, 90890-03153	This tool is used to measure the fuel pressure.	

SPECIAL TOOLS

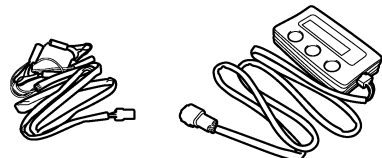
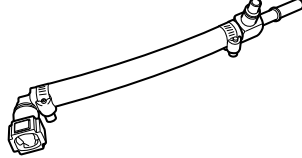
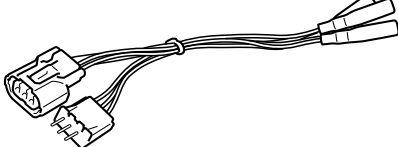
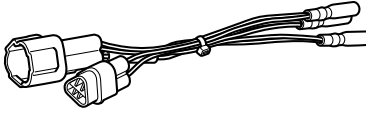
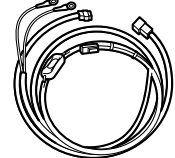
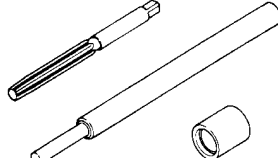
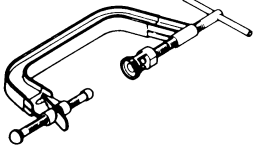
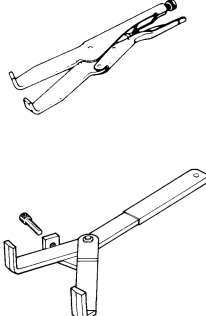
Tool name/Part number	How to use	Illustration
FI diagnostic tool YU-03182, 90890-03182	This tool is used to check the fault codes and diagnose any problems.	
Fuel pressure adapter YM-03186, 90890-03186	This tool is used to attach the pressure gauge.	
Test harness S-pressure sensor (3P) YU-03207, 90890-03207	This tool is connected between the intake air pressure sensor and the wire harness and is used to measure the voltage.	
Test harness-speed sensor (3P) YU-03208, 90890-03208	This tool is connected between the throttle position sensor and the wire harness and is used to measure the voltage.	
FI diagnostic tool sub-lead YU-03212, 90890-03212	This tool is used to connect the FI diagnostic tool to a battery.	
Valve guide remover & installer set 90890-04016	This tool is needed to remove and install the valve guide.	
Valve spring compressor YM-4019, 90890-04019	This tool is needed to remove and install the valve assemblies.	
Clutch holding tool YM-91042, 90890-04086	This tool is used to hold the clutch when removing or installing the clutch boss securing nut.	

SPECIAL TOOLS

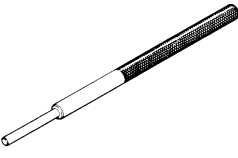
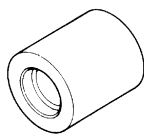
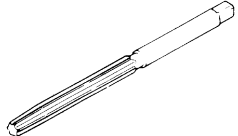
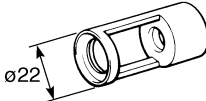
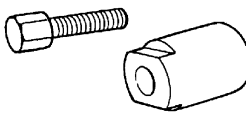
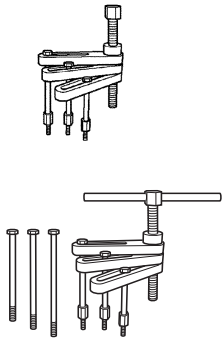
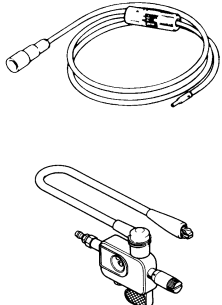
Tool name/Part number	How to use	Illustration
Valve guide remover 5.5 mm (0.22 in) YM-01122	This tool is needed to remove and install the valve guide.	
Valve guide installer 5.5 mm (0.22 in) YM-04015	This tool is needed to install the valve guide.	
Valve guide reamer 5.5 mm (0.22 in) YM-01196	This tool is needed to rebore the new valve guide.	
Valve spring compressor attachment YM-04108, 90890-04108	This tool is needed to remove and install the valve assemblies.	
Rotor puller YM-04151, 90890-04151	This tool is used to remove the fly-wheel magneto.	
Crankcase separating tool YU-A9642 90890-04152	These tool is used to remove the crankshaft from either case.	
Dynamic spark tester YM-34487 Ignition checker 90890-06754	This instrument is necessary for checking the ignition system components.	

SPECIAL TOOLS

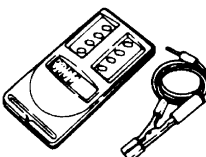
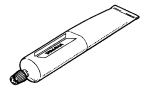
Tool name/Part number	How to use	Illustration
Digital tachometer YU-39951-B, 90890-06760	This tool is needed for observing engine rpm.	
YAMAHA Bond No. 1215 (Three-Bond® No. 1215) 90890-85505	This sealant (Bond) is used for crankcase mating surface, etc.	

CONTROL FUNCTIONS

ENGINE STOP SWITCH

The engine stop switch "1" is located on the left handlebar. Continue pushing the engine stop switch till the engine comes to a stop.

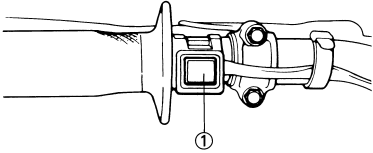

CLUTCH LEVER

The clutch lever "1" is located on the left handlebar; it disengages or engages the clutch. Pull the clutch lever to the handlebar to disengage the clutch, and release the lever to engage the clutch. The lever should be pulled rapidly and released slowly for smooth starts.

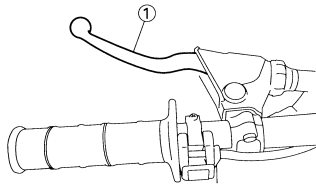

SHIFT PEDAL

The gear ratios of the constant-mesh 5 speed transmission are ideally spaced. The gears can be shifted by using the shift pedal "1" on the left side of the engine.

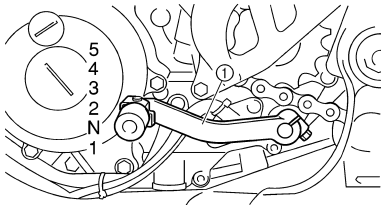

KICKSTARTER CRANK

Rotate the kickstarter crank "1" away from the engine. Push the starter down lightly with your foot until the gears engage, then kick smoothly and forcefully to start the engine. This model has a primary kickstarter crank so the engine can be started in any gear if the clutch is disengaged. In normal practices, however, shift to neutral before starting.

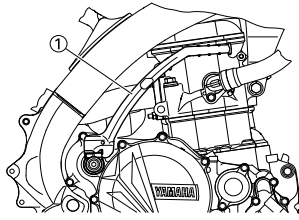

THROTTLE GRIP

The throttle grip "1" is located on the right handlebar; it accelerates or decelerates the engine. For acceleration, turn the grip toward you; for deceleration, turn it away from you.

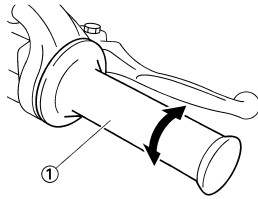

FRONT BRAKE LEVER

The front brake lever "1" is located on the right handlebar. Pull it toward the handlebar to activate the front brake.

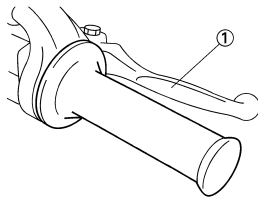

REAR BRAKE PEDAL

The rear brake pedal "1" is located on the right side of the machine. Press down on the brake pedal to activate the rear brake.



STARTER KNOB/IDLE SCREW

The starter knob/idle screw "1" is used when starting a cold engine. Pull the starter knob/idle screw out to open the circuit for starting. When the engine has warmed up, push it in to close the circuit.

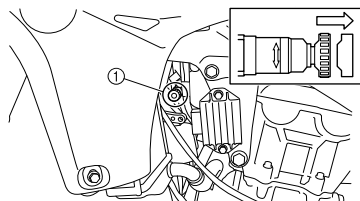

STARTING AND BREAK-IN FUEL

Always use the recommended fuel as stated below. Also, be sure to use new gasoline the day of a race.



Recommended fuel:
Premium unleaded gasoline only

NOTICE

Use only unleaded gasoline. The use of leaded gasoline will cause severe damage to the engine internal parts such as valves, piston rings, and exhaust system, etc.

TIP

Your Yamaha engine has been designed to use premium unleaded gasoline with a pump octane number $[(R+M)/2]$ of 91 or higher, or a research octane number of 95 or higher. If knocking (or pinging) occurs, use a gasoline of a different brand.

WARNING

- For refueling, be sure to stop the engine and use enough care not to spill any fuel. Also be sure to avoid refueling close to a fire.
- Refuel after the engine, exhaust pipe, etc. have cooled off.

Gasohol (For USA and Canada)

There are two types of gasohol: gasohol containing ethanol and that containing methanol. Gasohol containing ethanol can be used if the ethanol content does not exceed 10%. Gasohol containing methanol is not recommended by Yamaha because it can cause damage to the fuel system or vehicle performance problems.

HANDLING NOTE

WARNING

Never start or run the engine in a closed area. The exhaust fumes are poisonous; they can cause loss of consciousness and death in a very short time. Always operate the machine in a well-ventilated area.

STARTING AND BREAK-IN

NOTICE

- Unlike a two-stroke engine, this engine cannot be kick started when the throttle is open because the kickstarter may kick back. Also, if the throttle is open the air/fuel mixture may be too lean for the engine to start.
- Before starting the machine, perform the checks in the pre-operation check list.

AIR FILTER MAINTENANCE

According to "CLEANING THE AIR FILTER ELEMENT" section in the CHAPTER 3, apply the foam-air-filter oil or its equivalent to the element. (Excess oil in the element may adversely affect engine starting.)

STARTING A COLD ENGINE

1. Inspect the coolant level.
2. Shift the transmission into neutral.
3. Pull the starter knob/ idle screw "1" to its full length.

TIP

Use the starter knob/ idle screw below an air temperature of 15°C (59°F).

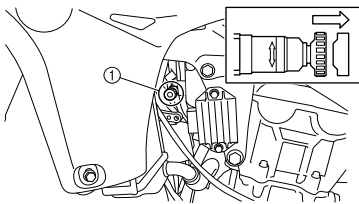

4. Push the kickstarter down lightly with your foot until resistance is felt.
5. With the throttle fully closed, fold out the kickstarter lever, move it down lightly with your foot until the gears engage, and then push it down smoothly but forcefully.

WARNING

Do not open the throttle while kicking the kickstarter crank. Otherwise, the kickstarter crank may kick back.

TIP

If the engine fails to start, give the kickstarter 10 to 20 slow kicks at full throttle in order to clear the engine of the rich air-fuel mixture retained in it.

6. When the engine starts running, warm it up one or two minutes at a steady speed (of 3,000 to 5,000 r/min), and then return the starter knob/ idle screw to its original position.

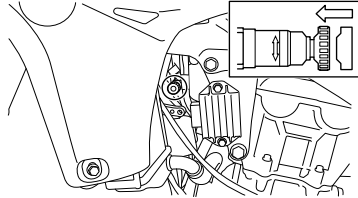

7. Push the engine stop switch "1".

NOTICE

Do not warm up the engine for extended periods of time.

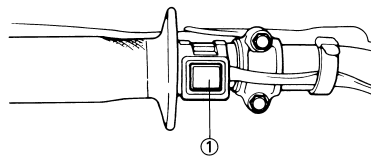

STARTING A WARM ENGINE

To start a warm engine, make sure that the starter (choke) knob/idling screw is pushed in and the throttle is closed, and then start the engine by pushing the kickstarter.

TIP

If the engine fails to start, give the kickstarter 10 to 20 slow kicks at full throttle in order to clear the engine of the rich air-fuel mixture retained in it.

BREAK-IN PROCEDURES

1. Before starting the engine, fill the fuel tank with the fuel.
2. Perform the pre-operation checks on the machine.
3. Start and warm up the engine. Check the idle speed, and check the operation of the controls and the engine stop switch. Then, restart the engine and check its operation within no more than 5 minutes after it is restarted.
4. Operate the machine in the lower gears at moderate throttle openings for five to eight minutes.
5. Check how the engine runs when the machine is ridden with the throttle 1/4 to 1/2 open (low to medium speed) for about one hour.

6. Restart the engine and check the operation of the machine throughout its entire operating range. Restart the machine and operate it for about 10 to 15 more minutes. The machine will now be ready to race.

NOTICE

- After the break-in or before each race, you must check the entire machine for loose fittings and fasteners as per "TORQUE-CHECK POINTS". Tighten all such fasteners as required.
- When any of the following parts have been replaced, they must be broken in.

CYLINDER AND CRANKSHAFT:

About one hour of break-in operation is necessary.

PISTON, RING, VALVES, CAM-SHAFTS AND GEARS:

These parts require about 30 minutes of break-in operation at half-throttle or less. Observe the condition of the engine carefully during operation.

TORQUE-CHECK POINTS

TORQUE-CHECK POINTS

Frame construction			Frame to rear frame
		Combined seat and fuel tank	Fuel tank to frame
Exhaust system			Silencer to rear frame
Engine mounting			Frame to engine
			Engine bracket to engine
			Engine bracket to frame
Steering		Steering stem to handlebar	Steering stem to frame
			Steering stem to upper bracket
			Upper bracket to handlebar
Suspension	Front	Steering stem to front fork	Front fork to upper bracket
			Front fork to lower bracket
	Rear	For link type	Assembly of links
			Link to frame
			Link to rear shock absorber
			Link to swingarm
	Installation of rear shock absorber	Rear shock absorber to frame	
	Installation of swingarm	Tightening of pivot shaft	
Wheel	Installation of wheel	Front	Tightening of wheel axle
			Tightening of axle holder
		Rear	Tightening of wheel axle
			Wheel to rear wheel sprocket
Brake		Front	Brake caliper to front fork
			Brake disc to wheel
			Tightening of union bolt
			Brake master cylinder to handlebar
			Tightening of bleed screw
			Tightening of brake hose holder
		Rear	Brake pedal to frame
			Brake disc to wheel
			Tightening of union bolt
			Brake master cylinder to frame
	Tightening of bleed screw		
	Tightening of brake hose holder		
Fuel system			Fuel pump to fuel tank

TIP

Concerning the tightening torque, refer to "TIGHTENING TORQUES" section in the CHAPTER 2.

CLEANING AND STORAGE

CLEANING

Frequent cleaning of your machine will enhance its appearance, maintain good overall performance, and extend the life of many components.

1. Before washing the machine, block off the end of the exhaust pipe to prevent water from entering. A plastic bag secured with a rubber band may be used for this purpose.
2. If the engine is excessively greasy, apply some degreaser to it with a paint brush. Do not apply degreaser to the chain, sprockets, or wheel axles.
3. Rinse the dirt and degreaser off with a garden hose; use only enough pressure to do the job.

NOTICE

Do not use high-pressure washers or steam-jet cleaners since they cause water seepage and deterioration seals.

4. After the majority of the dirt has been hosed off, wash all surfaces with warm water and a mild detergent. Use an old toothbrush to clean hard-to-reach places.
5. Rinse the machine off immediately with clean water, and dry all surfaces with a soft towel or cloth.
6. Immediately after washing, remove excess water from the chain with a paper towel and lubricate the chain to prevent rust.
7. Clean the seat with a vinyl upholstery cleaner to keep the cover pliable and glossy.
8. Automotive wax may be applied to all painted or chromed surfaces. Avoid combination cleaner-waxes, as they may contain abrasives.
9. After completing the above, start the engine and allow it to idle for several minutes.

STORAGE

If your machine is to be stored for 60 days or more, some preventive measures must be taken to avoid deterioration. After cleaning the machine thoroughly, prepare it for storage as follows:

1. Fill up the fuel tank and add fuel stabilizer (if available) to prevent the fuel tank from rusting and the fuel from deteriorating.
2. Remove the spark plug, pour a tablespoon of SAE 10W-40 motor oil in the spark plug hole, and re-install the plug. With the engine stop switch pushed in, kick the engine over several times to coat the cylinder walls with oil.
3. Remove the drive chain, clean it thoroughly with solvent, and lubricate it. Reinstall the chain or store it in a plastic bag tied to the frame.
4. Lubricate all control cables.
5. Block the frame up to raise the wheels off the ground.
6. Tie a plastic bag over the exhaust pipe outlet to prevent moisture from entering.
7. If the machine is to be stored in a humid or salt-air environment, coat all exposed metal surfaces with a film of light oil. Do not apply oil to rubber parts or the seat cover.

TIP

Make any necessary repairs before the machine is stored.

GENERAL SPECIFICATIONS

2

SPECIFICATIONS

GENERAL SPECIFICATIONS

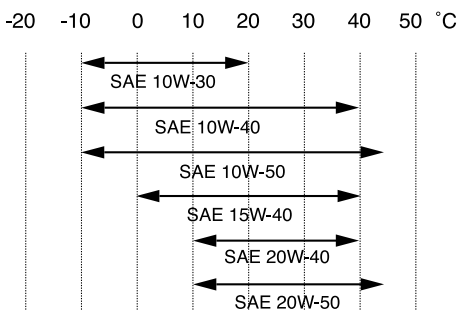
Model name:	YZ450FB (USA, CDN, AUS, NZ) YZ450F (EUROPE, ZA)		
Model code number:	33D9 (USA, CDN) 33DA (EUROPE) 33DC (AUS, NZ, ZA)		
Dimensions:	USA, CDN	EUROPE	AUS, NZ, ZA
Overall length	2,195 mm (86.42 in)	2,191 mm (86.26 in)	2,196 mm (86.46 in)
Overall width	825 mm (32.48 in)	←	←
Overall height	1,312 mm (51.65 in)	1,311 mm (51.61 in)	1,312 mm (51.65 in)
Seat height	999 mm (39.33 in)	←	998 mm (39.29 in)
Wheelbase	1,492 mm (58.74 in)	1,487 mm (58.54 in)	←
Minimum ground clearance	384 mm (15.12 in)	383 mm (15.08 in)	←
Weight:			
Curb weight	111 kg (245 lb)		
Engine:			
Engine type	Liquid cooled 4-stroke, DOHC		
Cylinder arrangement	Single cylinder		
Displacement	449.7 cm ³ (15.8 Imp oz, 15.2 US oz)		
Bore × stroke	97.0 × 60.8 mm (3.82 × 2.39 in)		
Compression ratio	12.5 : 1		
Starting system	Kickstarter		
Lubrication system:	Dry sump		
Oil type or grade:			
Engine oil			
	Recommended brand: YAMALUBE SAE10W-30, SAE10W-40, SAE10W-50, SAE15W-40, SAE20W-40 or SAE20W-50 API service SG type or higher, JASO standard MA		
Oil capacity:			
Engine oil			
Periodic oil change	0.95 L (0.84 Imp qt, 1.00 US qt)		
With oil filter replacement	1.0 L (0.88 Imp qt, 1.06 US qt)		
Total amount	1.2 L (1.06 Imp qt, 1.27 US qt)		
Coolant capacity (including all routes):	1.13 L (0.99 Imp qt, 1.19 US qt)		
Air filter:	Wet type element		

GENERAL SPECIFICATIONS

Fuel:			
Type	Premium unleaded gasoline only		
Tank capacity	6.2 L (1.40 Imp gal, 1.64 US gal)		
Throttle body:			
Type	30RA		
Manufacturer	KEIHIN		
Spark plug:			
Type/manufacturer	CR8E/NGK (resistance type)		
Gap	0.7–0.8 mm (0.028–0.031 in)		
Clutch type:	Wet, multiple-disc		
Transmission:			
Primary reduction system	Gear		
Primary reduction ratio	2.652 (61/23)		
Final drive	Chain		
Secondary reduction ratio	3.692 (48/13) (For USA, CDN) 3.769 (49/13) (For EUROPE, AUS, NZ, ZA)		
Transmission type	Constant mesh, 5-speed		
Operation	Left foot operation		
Gear ratio:			
1st	1.929 (27/14)		
2nd	1.533 (23/15)		
3rd	1.278 (23/18)		
4th	1.091 (24/22)		
5th	0.952 (20/21)		
Chassis:	USA, CDN	EUROPE	AUS, NZ, ZA
Frame type	Semi double cradle	←	←
Caster angle	26.95°	26.80°	27.00°
Trail	119 mm (4.69 in)	117 mm (4.61 in)	120 mm (4.72 in)
Tire:			
Type	With tube		
Size (front)	80/100-21 51M		
Size (rear)	120/80-19 63M (For USA, CDN, AUS, NZ, ZA) 110/90-19 62M (For EUROPE)		
Tire pressure (front and rear)	100 kPa (1.0 kgf/cm ² , 15 psi)		
Brake:			
Front brake type	Single disc brake		
Operation	Right hand operation		
Rear brake type	Single disc brake		
Operation	Right foot operation		
Suspension:			
Front suspension	Telescopic fork		
Rear suspension	Swingarm (link type monocross suspension)		
Shock absorber:			
Front shock absorber	Coil spring/oil damper		
Rear shock absorber	Coil spring/gas, oil damper		

MAINTENANCE SPECIFICATIONS

Wheel travel: Front wheel travel Rear wheel travel	310 mm (12.2 in) 315 mm (12.4 in) (For USA, CDN) 312 mm (12.3 in) (For EUROPE, AUS, NZ, ZA)
Electrical: Ignition system	TCI

MAINTENANCE SPECIFICATIONS

ENGINE

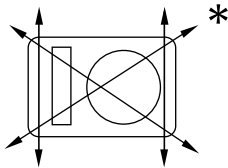
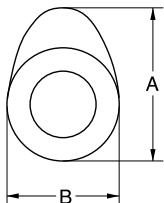
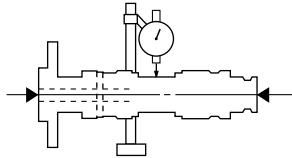
Item	Standard	Limit
Cylinder head: Warp limit 	----	0.05 mm (0.002 in)
Cylinder: Bore size Out of round limit	97.00–97.01 mm (3.8189–3.8193 in) ----	---- 0.05 mm (0.002 in)
Camshaft: Drive method Camshaft cap inside diameter Camshaft outside diameter Shaft-to-cap clearance Cam dimensions 	Chain drive (Left) 22.000–22.021 mm (0.8661–0.8670 in) 21.959–21.972 mm (0.8645–0.8650 in) 0.028–0.062 mm (0.0011–0.0024 in)	---- ---- ---- 0.08 mm (0.003 in)
Intake "A" Intake "B" Exhaust "A" Exhaust "B" Camshaft runout limit 	37.750–37.850 mm (1.4862–1.4902 in) 28.129–28.229 mm (1.1074–1.1114 in) 33.540–33.640 mm (1.3205–1.3244 in) 24.769–24.869 mm (0.9752–0.9791 in) ----	37.650 mm (1.4823 in) 28.029 mm (1.1035 in) 33.440 mm (1.3165 in) 24.669 mm (0.9712 in) 0.03 mm (0.0012 in)

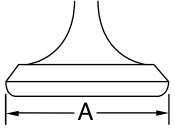
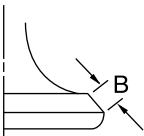
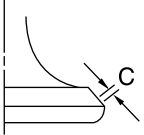
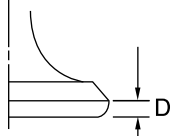

MAINTENANCE SPECIFICATIONS

Item	Standard	Limit
Timing chain:		
Timing chain type/No. of links	98XRH2010-122M/122	----
Timing chain adjustment method	Automatic	----
Valve, valve seat, valve guide:		
Valve clearance (cold)		
IN	0.10–0.15 mm (0.0039–0.0059 in)	----
EX	0.20–0.25 mm (0.0079–0.0098 in)	----
Valve dimensions:		
"A" head diameter (IN)	35.9–36.1 mm (1.4134–1.4213 in)	----
"A" head diameter (EX)	29.9–30.1 mm (1.1772–1.1850 in)	----
		
"B" face width (IN)	2.26 mm (0.089 in)	----
"B" face width (EX)	2.26 mm (0.089 in)	----
		
"C" seat width (IN)	0.9–1.1 mm (0.0354–0.0433 in)	1.6 mm (0.0630 in)
"C" seat width (EX)	0.9–1.1 mm (0.0354–0.0433 in)	1.6 mm (0.0630 in)
		
"D" margin thickness (IN)	1.3 mm (0.0512 in)	----
"D" margin thickness (EX)	1.0 mm (0.0394 in)	----
		
Stem outside diameter (IN)	5.475–5.490 mm (0.2156–0.2161 in)	5.445 mm (0.2144 in)
Stem outside diameter (EX)	5.465–5.480 mm (0.2152–0.2157 in)	5.435 mm (0.2140 in)
Guide inside diameter (IN)	5.500–5.512 mm (0.2165–0.2170 in)	5.550 mm (0.2185 in)
Guide inside diameter (EX)	5.500–5.512 mm (0.2165–0.2170 in)	5.550 mm (0.2185 in)

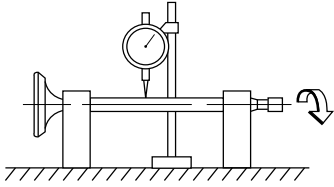
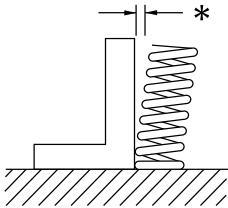
MAINTENANCE SPECIFICATIONS

Item	Standard	Limit
Stem-to-guide clearance (IN)	0.010–0.037 mm (0.0004–0.0015 in)	0.08 mm (0.003 in)
Stem-to-guide clearance (EX)	0.020–0.047 mm (0.0008–0.0019 in)	0.10 mm (0.004 in)
Stem runout limit	----	0.01 mm (0.0004 in)
		
Valve seat width (IN)	0.9–1.1 mm (0.0354–0.0433 in)	1.6 mm (0.0630 in)
Valve seat width (EX)	0.9–1.1 mm (0.0354–0.0433 in)	1.6 mm (0.0630 in)
Valve spring:		
Free length (IN)	40.76 mm (1.60 in)	39.76 mm (1.57 in)
Free length (EX)	37.01mm (1.46 in)	36.01 mm (1.42 in)
Set length (valve closed) (IN)	34.78 mm (1.37 in)	----
Set length (valve closed) (EX)	30.83 mm (1.21 in)	----
Compressed force (installed) (IN)	178–204 N at 34.78 mm (18.2–20.8 kg at 34.78 mm, 40.01–45.86 lb at 1.37 in)	----
Compressed force (installed) (EX)	124–142 N at 30.83 mm (12.6–14.5 kg at 30.83 mm, 27.88–31.92 lb at 1.21 in)	----
Tilt limit* (IN)	----	2.5°/1.8 mm (2.5°/0.071 in)
Tilt limit* (EX)	----	2.5°/1.6 mm (2.5°/0.063 in)
		
Direction of winding (top view) (IN)	Clockwise	----
Direction of winding (top view) (EX)	Clockwise	----

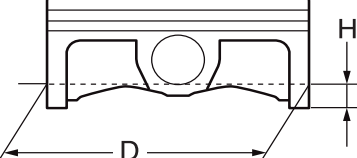
MAINTENANCE SPECIFICATIONS

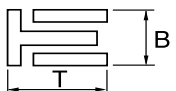
Item	Standard	Limit
Piston:		
Piston to cylinder clearance	0.020–0.045 mm (0.0008–0.0018 in)	0.1 mm (0.004 in)
Piston size "D"	96.965–96.980 mm (3.8175–3.8181 in)	----
		
Measuring point "H"	9.0 mm (0.354 in)	----
Piston off-set	Zero mm (Zero in)	----
Piston pin bore inside diameter	18.004–18.015 mm (0.7088–0.7093 in)	18.045 mm (0.7104 in)
Piston pin outside diameter	17.991–18.000 mm (0.7083–0.7087 in)	17.971 mm (0.7075 in)
Piston rings:		
Top ring:		
		
Type	Barrel	----
Dimensions (B × T)	1.00 × 3.30 mm (0.04 × 0.13 in)	----
End gap (installed)	0.20–0.30 mm (0.008–0.012 in)	0.55 mm (0.022 in)
Side clearance (installed)	0.015–0.065 mm (0.0006–0.0026 in)	0.120 mm (0.0047 in)
2nd ring:		
		
Type	Taper	----
Dimensions (B × T)	1.00 × 3.10 mm (0.04 × 0.12 in)	----
End gap (installed)	0.35–0.50 mm (0.014–0.020 in)	0.85 mm (0.033 in)
Side clearance	0.020–0.060 mm (0.0008–0.0024 in)	0.120 mm (0.0047 in)
Oil ring:		
		
Dimensions (B × T)	1.5 × 2.55 mm (0.06 × 0.10 in)	----
End gap (installed)	0.20–0.50 mm (0.008–0.020 in)	----

MAINTENANCE SPECIFICATIONS

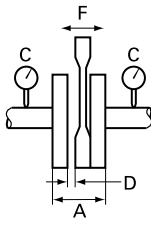
Item	Standard	Limit
Crankshaft: Crank width "A" Runout limit "C" Big end side clearance "D" Small end free play "F" <div style="text-align: center; margin-top: 10px;">  </div>	61.95–62.00 mm (2.439–2.441 in) 0.03 mm (0.0012 in) 0.15–0.45 mm (0.0059–0.0177 in) 0.4–1.0 mm (0.02–0.04 in)	---- 0.05 mm (0.002 in) 0.50 mm (0.02 in) 2.0 mm (0.08 in)
Balancer: Balancer drive method	Gear	----
Air filter oil grade:	Foam-air-filter oil or equivalent oil	----
Clutch: Friction plate thickness Quantity Clutch plate thickness Quantity Warp limit Clutch spring free length Quantity Clutch housing thrust clearance Clutch housing radial clearance Clutch release method	2.92–3.08 mm (0.115–0.121 in) 8 1.5–1.7 mm (0.059–0.067 in) 7 ---- 50.0 mm (1.97 in) 6 0.10–0.35 mm (0.0039–0.0138 in) 0.010–0.044 mm (0.0004–0.0017 in) Inner push, cam push	2.8 mm (0.110 in) ---- ---- 0.1 mm (0.004 in) 49.0 mm (1.93 in) ---- ---- ---- ----
Shifter: Shifter type Guide bar bending limit	Cam drum and guide bar ----	---- 0.05 mm (0.002 in)
Kickstarter: Type	Kick and ratchet type	----
Fuel pump: Fuel pressure	324 kPa (3.24 kg/cm ² , 46.1 psi)	----
Fuel injector: Model/manufacturer	1010/DENSO	----
Throttle body: I. D. mark Manufacturer	33D1 00 KEIHIN	---- ---- ----

MAINTENANCE SPECIFICATIONS

Item	Standard	Limit
Throttle position sensor:		
Throttle position sensor maximum resistance	5 k Ω	----
Throttle position sensor variable resistance	0–2 k Ω (full closed)	----
Throttle position sensor input voltage	4–6 V	----
Fuel injection sensor:		
Crankshaft position sensor resistance	248–372 Ω	----
Intake air pressure sensor output voltage	3.57–3.71 V at 101.3kPa (1.013 kg/cm ² , 14.41 psi)	----
Atmospheric pressure sensor output voltage	3.57–3.71 V at 101.3kPa (1.013 kg/cm ² , 14.41 psi)	----
Intake air temperature sensor	5.4–6.6 k Ω at 0 °C (32 °F) 290–390 Ω at 80 °C (176 °F)	----
Idling condition:		
Engine idle speed	1,900–2,100 r/min	----
Oil temperature	55–65 °C (131–149 °F)	----
Lubrication system:		
Oil filter type	Paper type	----
Oil pump type	Trochoid type	----
Tip clearance	0.12 mm or less (0.0047 in or less)	0.20 mm (0.008 in)
Side clearance	0.09–0.17 mm (0.0035–0.0067 in)	0.24 mm (0.009 in)
Housing and rotor clearance	0.03–0.10 mm (0.0012–0.0039 in)	0.17 mm (0.007 in)
Bypass valve setting pressure	40–80 kPa (0.4–0.8 kg/cm ² , 5.69–11.38 psi)	----
Cooling:		
Radiator core size		
Width	121.4 mm (4.78 in)	----
Height	235 mm (9.25 in)	----
Thickness	28 mm (1.10 in)	----
Radiator cap opening pressure	108–137 kPa (1.08–1.37 kg/cm ² , 15.4–19.5 psi)	----
Radiator capacity (total)	0.62 L (0.55 Imp qt, 0.66 US qt)	----
Water pump		
Type	Single-suction centrifugal pump	----

MAINTENANCE SPECIFICATIONS

CHASSIS

Item	Standard		Limit
Steering system:			
Steering bearing type	Taper roller bearing		----
Front suspension:	USA, CDN	EUROPE, AUS, NZ, ZA	
Front fork travel	310 mm (12.2 in)	←	----
Fork spring free length	470 mm (18.5 in)	←	465 mm (18.3 in)
Spring rate, STD	K = 4.6 N/mm (0.469 kg/mm, 26.3 lb/in)	←	----
Optional spring	Yes	←	----
Oil capacity	551 cm ³ (19.4 Imp oz, 18.63 US oz)	←	----
Oil grade	Suspension oil "S1"	←	----
Inner tube outer diameter	48 mm (1.89 in)	←	----
Front fork top end	Zero mm (Zero in)	←	----
Rear suspension:	USA, CDN	EUROPE, AUS, NZ, ZA	
Shock absorber travel	132.0 mm (5.20 in)	←	----
Spring free length	260 mm (10.24 in)	←	254.8 mm (10.03 in)
Fitting length	250 mm (9.84 in)	246 mm (9.69 in)	----
Preload length <Min.–Max.>	1.5–18 mm (0.06–0.71 in)	←	----
Spring rate, STD	K = 56.0 N/mm (5.7 kg/mm, 319.2 lb/in)	K = 54.0 N/mm (5.5 kg/mm, 308.0 lb/in)	----
Optional spring	Yes	←	----
Enclosed gas pressure	1,000 kPa (10 kg/cm ² , 142 psi)	←	----
Swingarm:			
Swingarm free play limit End	----		1.0 mm (0.04 in)
Wheel:			
Front wheel type	Spoke wheel		----
Rear wheel type	Spoke wheel		----
Front rim size/material	21 × 1.60/Aluminum		----
Rear rim size/material	19 × 2.15/Aluminum		----
Rim runout limit:			
Radial	----		2.0 mm (0.08 in)
Lateral	----		2.0 mm (0.08 in)
Drive chain:			
Type/manufacturer	DID520DMA2 SDH/DAIDO		----
Number of links	113 links + joint		----
Chain slack	50–60 mm (2.0–2.4 in)		----
Chain length (15 links)	----		242.9 mm (9.563 in)

MAINTENANCE SPECIFICATIONS

Item	Standard	Limit
Front disc brake:		
Disc outside dia.xThickness	250 × 3.0 mm (9.84 × 0.12 in)	250 × 2.5 mm (9.84 × 0.10 in)
Pad thickness	4.4 mm (0.17 in)	1.0 mm (0.04 in)
Master cylinder inside dia.	9.52 mm (0.375 in)	----
Caliper cylinder inside dia.	22.65 mm (0.892 in) × 2	----
Brake fluid type	DOT #4	----
Rear disc brake:		
Disc outside dia.xThickness	245 × 4.0 mm (9.65 × 0.16 in)	245 × 3.5 mm (9.65 × 0.14 in)
Deflection limit	----	0.15 mm (0.006 in)
Pad thickness	6.4 mm (0.25 in)	1.0 mm (0.04 in)
Master cylinder inside dia.	11.0 mm (0.433 in)	----
Caliper cylinder inside dia.	25.4 mm (1.000 in) × 1	----
Brake fluid type	DOT #4	----
Brake lever and brake pedal:		
Brake lever position	95 mm (3.74 in)	----
Brake pedal height (vertical height above footrest top)	Zero mm (Zero in)	----
Clutch lever free play (lever end)	7–12 mm (0.28–0.47 in)	----
Throttle grip free play	3–5 mm (0.12–0.20 in)	----

ELECTRICAL

Item	Standard	Limit
Ignition system:		
Advancer type	Electrical	----
AC magneto:		
Magneto-model (stator)/manufacturer	33D00/YAMAHA	----
Stator coil resistance (color)	0.60–0.90 Ω at 20 °C (68 °F) (White–White)	----
Crankshaft position sensor resistance (color)	248–372 Ω at 20 °C (68 °F) (Gray–Black)	----
ECU-model/manufacturer	33D7 (USA, CDN) 33D4 (EUROPE) 33D6 (AUS, NZ, ZA)	----
Ignition coil:		
Model/manufacturer	F6T541/MITSUBISHI	----
Minimum spark gap	6 mm (0.24 in)	----
Primary coil resistance	3.57–4.83 Ω at 20 °C (68 °F)	----
Secondary coil resistance	10.71–14.49 kΩ at 20 °C (68 °F)	----
Coolant temperature sensor:		
Coolant temperature sensor resistance	2.51–2.78 kΩ at 20 °C (68 °F) 210–220 kΩ at 100 °C (212 °F)	----





TIGHTENING TORQUES

TIGHTENING TORQUES











ENGINE

TIP

△ - marked portion shall be checked for torque tightening after break-in or before each race.

Item	Thread size	Q'ty	Tightening torque	Remarks
Spark plug	M10S	1	13 Nm (1.3 m•kg, 9.4 ft•lb)	
Camshaft cap	M6	8	10 Nm (1.0 m•kg, 7.2 ft•lb)	
Cylinder head blind plug screw	M12	2	28 Nm (2.8 m•kg, 20 ft•lb)	
Oil passage plug	M8	1	15 Nm (1.5 m•kg, 11 ft•lb)	
Cylinder head (stud bolt)	M6	3	7 Nm (0.7 m•kg, 5.1 ft•lb)	
Cylinder head (bolt)	M10	4	Refer to TIP.* ¹	
Cylinder head (bolt)	M6	2	10 Nm (1.0 m•kg, 7.2 ft•lb)	
Cylinder head cover	M6	3	10 Nm (1.0 m•kg, 7.2 ft•lb)	
Cylinder	M6	1	10 Nm (1.0 m•kg, 7.2 ft•lb)	
Timing chain tensioner	M6	2	10 Nm (1.0 m•kg, 7.2 ft•lb)	
Timing chain tensioner cap bolt	M6	1	7 Nm (0.7 m•kg, 5.1 ft•lb)	
Timing chain guide stopper plate (exhaust side)	M6	2	10 Nm (1.0 m•kg, 7.2 ft•lb)	
Exhaust pipe (nut)	M6	3	10 Nm (1.0 m•kg, 7.2 ft•lb)	
Exhaust pipe and frame	M8	1	20 Nm (2.0 m•kg, 14 ft•lb)	
△ Silencer	M8	2	30 Nm (3.0 m•kg, 22 ft•lb)	
Silencer clamp (front)	M8	1	12 Nm (1.2 m•kg, 8.7 ft•lb)	
Silencer clamp (rear)	M8	1	16 Nm (1.6 m•kg, 11 ft•lb)	
Starter knob/Idle screw	M12	1	2 Nm (0.2 m•kg, 1.4 ft•lb)	
Throttle body joint	M6	2	10 Nm (1.0 m•kg, 7.2 ft•lb)	
Throttle body joint clamp	M5	1	3 Nm (0.3 m•kg, 2.2 ft•lb)	
△ Air filter case	M6	3	7 Nm (0.7 m•kg, 5.1 ft•lb)	
Air filter joint and air filter case	M4	9	1 Nm (0.1 m•kg, 0.7 ft•lb)	
Air filter case cover	M5	2	5 Nm (0.5 m•kg, 3.6 ft•lb)	
Air filter joint clamp	M4	1	4 Nm (0.4 m•kg, 2.9 ft•lb)	
Throttle cable adjust bolt and locknut	M6	1	4 Nm (0.4 m•kg, 2.9 ft•lb)	
Throttle cable (pull)	M10	1	7 Nm (0.7 m•kg, 5.1 ft•lb)	
Throttle cable (return)	M10	1	7 Nm (0.7 m•kg, 5.1 ft•lb)	
Throttle cable cover	M5	2	4 Nm (0.4 m•kg, 2.9 ft•lb)	
Air duct	M6	3	7 Nm (0.7 m•kg, 5.1 ft•lb)	
Radiator	M6	4	10 Nm (1.0 m•kg, 7.2 ft•lb)	
Radiator hose clamp	M6	8	2 Nm (0.2 m•kg, 1.4 ft•lb)	
Radiator pipe 1	M6	1	10 Nm (1.0 m•kg, 7.2 ft•lb)	
Radiator pipe 2	M6	1	10 Nm (1.0 m•kg, 7.2 ft•lb)	
Impeller	M8	1	14 Nm (1.4 m•kg, 10 ft•lb)	
Water pump housing cover	M6	4	10 Nm (1.0 m•kg, 7.2 ft•lb)	
Coolant drain bolt	M6	1	10 Nm (1.0 m•kg, 7.2 ft•lb)	
Oil pump cover	M4	1	2 Nm (0.2 m•kg, 1.4 ft•lb)	
Oil pump	M6	2	10 Nm (1.0 m•kg, 7.2 ft•lb)	
Oil pump drive gear shaft	M6	1	10 Nm (1.0 m•kg, 7.2 ft•lb)	

TIGHTENING TORQUES

Item	Thread size	Q'ty	Tightening torque	Remarks
Oil filter element cover	M6	2	10 Nm (1.0 m•kg, 7.2 ft•lb)	
Oil pressure check bolt	M6	2	10 Nm (1.0 m•kg, 7.2 ft•lb)	
Crankshaft end accessing screw	M36	1	10 Nm (1.0 m•kg, 7.2 ft•lb)	
Timing mark accessing screw	M14	1	6 Nm (0.6 m•kg, 4.3 ft•lb)	
Clutch cover	M6	7	10 Nm (1.0 m•kg, 7.2 ft•lb)	
Right crankcase cover	M6	9	10 Nm (1.0 m•kg, 7.2 ft•lb)	
Left crankcase cover	M6	8	10 Nm (1.0 m•kg, 7.2 ft•lb)	
Crankcase	M6	13	12 Nm (1.2 m•kg, 8.7 ft•lb)	
Clutch cable holder	M6	2	10 Nm (1.0 m•kg, 7.2 ft•lb)	
Oil drain bolt	M8	1	20 Nm (2.0 m•kg, 14 ft•lb)	
Oil drain bolt	M8	1	20 Nm (2.0 m•kg, 14 ft•lb)	
Oil check bolt (crankcase)	M6	1	10 Nm (1.0 m•kg, 7.2 ft•lb)	
Oil strainer	M6	1	10 Nm (1.0 m•kg, 7.2 ft•lb)	
Oil nozzle	M5	1	8 Nm (0.8 m•kg, 5.8 ft•lb)	
Crankcase bearing stopper	M6	8	10 Nm (1.0 m•kg, 7.2 ft•lb)	
Crankcase bearing stopper (crankshaft)	M8	4	22 Nm (2.2 m•kg, 16 ft•lb)	Stake.
Drive axle oil seal stopper	M6	2	10 Nm (1.0 m•kg, 7.2 ft•lb)	
Kick shaft ratchet wheel guide	M6	2	12 Nm (1.2 m•kg, 8.7 ft•lb)	Lock washer 
Kickstarter crank	M8	1	33 Nm (3.3 m•kg, 24 ft•lb)	
Screw (kickstarter crank)	M6	1	7 Nm (0.7 m•kg, 5.1 ft•lb)	
Primary drive gear	M20	1	100 Nm (10.0 m•kg, 72 ft•lb)	
Clutch boss	M20	1	75 Nm (7.5 m•kg, 54 ft•lb)	
Clutch cable locknut	M8	1	7 Nm (0.7 m•kg, 5.1 ft•lb)	
Clutch cable adjust bolt and locknut	M6	1	4 Nm (0.4 m•kg, 2.9 ft•lb)	
Clutch spring	M6	6	10 Nm (1.0 m•kg, 7.2 ft•lb)	
Balancer	M10	1	45 Nm (4.5 m•kg, 32 ft•lb)	Lock washer
Balancer shaft driven gear	M14	1	50 Nm (5.0 m•kg, 36 ft•lb)	Lock washer
Balancer weight	M6	3	10 Nm (1.0 m•kg, 7.2 ft•lb)	
Drive sprocket	M20	1	75 Nm (7.5 m•kg, 54 ft•lb)	Lock washer
Drive chain sprocket cover	M6	2	7 Nm (0.7 m•kg, 5.1 ft•lb)	
Shift pedal	M6	1	12 Nm (1.2 m•kg, 8.7 ft•lb)	
Shift guide	M6	2	10 Nm (1.0 m•kg, 7.2 ft•lb)	
Stopper lever	M6	1	10 Nm (1.0 m•kg, 7.2 ft•lb)	
Segment	M8	1	30 Nm (3.0 m•kg, 22 ft•lb)	

TIP





*1: Tighten the cylinder head bolts to 30 Nm (3.0 m•kg, 22 ft•lb) in the proper tightening sequence, remove and retighten the cylinder head bolts to 20 Nm (2.0 m•kg, 14 ft•lb) in the proper tightening sequence, and then tighten the cylinder head bolts further to reach the specified angle 150° in the proper tightening sequence.

TIGHTENING TORQUES

CHASSIS

TIP

△ - marked portion shall be checked for torque tightening after break-in or before each race.

	Item	Thread size	Q'ty	Tightening torque	Remarks
△	Upper bracket and outer tube	M8	4	21 Nm (2.1 m•kg, 15 ft•lb)	
△	Lower bracket and outer tube	M8	4	21 Nm (2.1 m•kg, 15 ft•lb)	
△	Upper bracket and steering stem	M24	1	145 Nm (14.5 m•kg, 105 ft•lb)	
△	Handlebar upper holder	M8	4	28 Nm (2.8 m•kg, 20 ft•lb)	
△	Handlebar lower holder	M10	2	34 Nm (3.4 m•kg, 24 ft•lb)	
△	Steering ring nut	M28	1	Refer to TIP.	
	Front fork and damper assembly	M51	2	30 Nm (3.0 m•kg, 22 ft•lb)	
	Front fork and adjuster	M22	2	55 Nm (5.5 m•kg, 40 ft•lb)	Copper washer 
	Damper assembly and base valve	M42	2	29 Nm (2.9 m•kg, 21 ft•lb)	
	Adjuster and damper assembly	M12	2	29 Nm (2.9 m•kg, 21 ft•lb)	
	Bleed screw (front fork) and base valve	M5	2	1 Nm (0.1 m•kg, 0.7 ft•lb)	
△	Front fork and front fork protector	M6	6	5 Nm (0.5 m•kg, 3.6 ft•lb)	
△	Front fork protector and brake hose holder	M6	2	8 Nm (0.8 m•kg, 5.8 ft•lb)	
	Throttle grip cap	M5	2	4 Nm (0.4 m•kg, 2.9 ft•lb)	
	Clutch lever holder	M6	2	5 Nm (0.5 m•kg, 3.6 ft•lb)	
	Clutch lever mounting nut	M6	1	4 Nm (0.4 m•kg, 2.9 ft•lb)	
	Clutch lever position lock nut	M5	1	5 Nm (0.5 m•kg, 3.6 ft•lb)	
△	Front brake master cylinder and bracket	M6	2	9 Nm (0.9 m•kg, 6.5 ft•lb)	
	Front brake master cylinder cap	M4	2	2 Nm (0.2 m•kg, 1.4 ft•lb)	
	Brake lever mounting bolt	M6	1	6 Nm (0.6 m•kg, 4.3 ft•lb)	
	Brake lever mounting nut	M6	1	6 Nm (0.6 m•kg, 4.3 ft•lb)	
	Brake lever position locknut	M6	1	5 Nm (0.5 m•kg, 3.6 ft•lb)	
△	Cable guide (front brake hose) and under bracket	M6	1	4 Nm (0.4 m•kg, 2.9 ft•lb)	
△	Front brake hose union bolt (brake master cylinder)	M10	1	30 Nm (3.0 m•kg, 22 ft•lb)	Copper washer
△	Front brake hose union bolt (brake caliper)	M10	1	30 Nm (3.0 m•kg, 22 ft•lb)	Copper washer
△	Front brake caliper and front fork	M8	2	28 Nm (2.8 m•kg, 20 ft•lb)	
	Brake caliper (front and rear) and pad pin plug	M10	2	2 Nm (0.2 m•kg, 1.4 ft•lb)	
△	Brake caliper (front and rear) and pad pin	M10	2	18 Nm (1.8 m•kg, 13 ft•lb)	
△	Brake caliper (front and rear) and bleed screw	M8	2	6 Nm (0.6 m•kg, 4.3 ft•lb)	
△	Front wheel axle and axle nut	M16	1	105 Nm (10.5 m•kg, 75 ft•lb)	
△	Front wheel axle holder	M8	4	21 Nm (2.1 m•kg, 15 ft•lb)	
△	Front brake disc and wheel hub	M6	6	12 Nm (1.2 m•kg, 8.7 ft•lb)	
△	Rear brake disc and wheel hub	M6	6	14 Nm (1.4 m•kg, 10 ft•lb)	
△	Footrest bracket and frame	M10	4	55 Nm (5.5 m•kg, 40 ft•lb)	TORX 

TIGHTENING TORQUES

	Item	Thread size	Q'ty	Tightening torque	Remarks
△	Brake pedal mounting	M8	1	26 Nm (2.6 m•kg, 19 ft•lb)	
	Brake pedal position locknut	M6	1	6 Nm (0.6 m•kg, 4.3 ft•lb)	
△	Rear brake master cylinder and frame	M6	2	10 Nm (1.0 m•kg, 7.2 ft•lb)	
	Rear brake master cylinder cap	M4	2	2 Nm (0.2 m•kg, 1.4 ft•lb)	
△	Rear brake hose union bolt (brake caliper)	M10	1	30 Nm (3.0 m•kg, 22 ft•lb)	Copper washer
△	Rear brake hose union bolt (brake master cylinder)	M10	1	30 Nm (3.0 m•kg, 22 ft•lb)	Copper washer
△	Rear wheel axle and axle nut	M22	1	135 Nm (13.5 m•kg, 98 ft•lb)	
△	Driven sprocket and wheel hub	M8	6	42 Nm (4.2 m•kg, 30 ft•lb)	
△	Nipple (spoke)	—	72	3 Nm (0.3 m•kg, 2.2 ft•lb)	
△	Disc cover and rear brake caliper	M6	2	10 Nm (1.0 m•kg, 7.2 ft•lb)	
△	Protector and rear brake caliper	M6	2	7 Nm (0.7 m•kg, 5.1 ft•lb)	
	Drive chain puller adjust bolt and locknut	M8	2	21 Nm (2.1 m•kg, 15 ft•lb)	
	Engine mounting:				
△	Upper engine bracket and frame	M8	4	45 Nm (4.5 m•kg, 32 ft•lb)	
△	Front engine bracket and frame	M8	4	34 Nm (3.4 m•kg, 24 ft•lb)	
△	Engine and engine bracket (front)	M10	1	53 Nm (5.3 m•kg, 38 ft•lb)	
△	Engine and engine bracket (upper)	M10	2	45 Nm (4.5 m•kg, 32 ft•lb)	
△	Engine and frame (lower)	M10	1	53 Nm (5.3 m•kg, 38 ft•lb)	
△	Engine guard	M6	1	10 Nm (1.0 m•kg, 7.2 ft•lb)	
	Lower engine guard	M6	3	10 Nm (1.0 m•kg, 7.2 ft•lb)	
△	Pivot shaft and nut	M16	1	85 Nm (8.5 m•kg, 61 ft•lb)	
△	Relay arm and swingarm	M14	1	70 Nm (7 m•kg, 50 ft•lb)	
△	Relay arm and connecting rod	M14	1	80 Nm (8.0 m•kg, 58 ft•lb)	
△	Connecting rod and frame	M14	1	80 Nm (8.0 m•kg, 58 ft•lb)	
△	Rear shock absorber and frame	M10	1	56 Nm (5.6 m•kg, 40 ft•lb)	
△	Rear shock absorber and relay arm	M10	1	53 Nm (5.3 m•kg, 38 ft•lb)	
△	Rear shock absorber locknut	M60	1	30 Nm (3.0 m•kg, 22 ft•lb)	
△	Rear frame and frame (upper)	M8	1	32 Nm (3.2 m•kg, 23 ft•lb)	
△	Rear frame and frame (lower)	M8	2	32 Nm (3.2 m•kg, 23 ft•lb)	
△	Swingarm and brake hose holder	M5	4	3 Nm (0.3 m•kg, 2.2 ft•lb)	
	Upper drive chain tensioner	M8	1	16 Nm (1.6 m•kg, 11 ft•lb)	
	Lower drive chain tensioner	M8	1	16 Nm (1.6 m•kg, 11 ft•lb)	
	Drive chain support and swingarm	M6	3	7 Nm (0.7 m•kg, 5.1 ft•lb)	
△	Seal guard and swingarm	M5	3	4 Nm (0.4 m•kg, 2.9 ft•lb)	
△	Fuel tank (front)	M6	2	9 Nm (0.9 m•kg, 6.5 ft•lb)	
	Fuel tank bracket (front)	M6	4	7 Nm (0.7 m•kg, 5.1 ft•lb)	
△	Fuel tank (rear)	M6	2	9 Nm (0.9 m•kg, 6.5 ft•lb)	
	Fuel tank bracket (rear)	M6	2	7 Nm (0.7 m•kg, 5.1 ft•lb)	
△	Fuel pump	M5	6	4 Nm (0.4 m•kg, 2.9 ft•lb)	
	Protector and fuel pump bracket	M5	2	4 Nm (0.4 m•kg, 2.9 ft•lb)	
	Fuel tank side cover	M6	4	7 Nm (0.7 m•kg, 5.1 ft•lb)	
	Fuel tank and seat set bracket	M6	1	7 Nm (0.7 m•kg, 5.1 ft•lb)	



TIGHTENING TORQUES

Item	Thread size	Q'ty	Tightening torque	Remarks
Seat	M8	2	22 Nm (2.2 m•kg, 16 ft•lb)	
△ Side cover	M6	4	7 Nm (0.7 m•kg, 5.1 ft•lb)	
Heat protector	M5	2	4 Nm (0.4 m•kg, 2.9 ft•lb)	
△ Air scoop and air duct	M6	2	7 Nm (0.7 m•kg, 5.1 ft•lb)	
Radiator and radiator guard	M6	2	10 Nm (1.0 m•kg, 7.2 ft•lb)	
△ Air scoop and radiator guard	M6	2	7 Nm (0.7 m•kg, 5.1 ft•lb)	
△ Front fender	M6	4	10 Nm (1.0 m•kg, 7.2 ft•lb)	
△ Rear fender (front)	M6	3	7 Nm (0.7 m•kg, 5.1 ft•lb)	
△ Rear fender (rear)	M6	2	18 Nm (1.8 m•kg, 13 ft•lb)	
△ Mud flap	—	2	1 Nm (0.1 m•kg, 0.7 ft•lb)	
△ Number plate	M6	1	7 Nm (0.7 m•kg, 5.1 ft•lb)	

TIP

1. First, tighten the steering ring nut approximately 38 Nm (3.8 m•kg, 27 ft•lb) by using the steering nut wrench, then loosen the steering ring nut one turn.
2. Retighten the steering ring nut 7 Nm (0.7 m•kg, 5.1 ft•lb).

ELECTRICAL

Item	Thread size	Q'ty	Tightening torque	Remarks
Stator	M5	3	8 Nm (0.8 m•kg, 5.8 ft•lb)	
Rotor	M12	1	65 Nm (6.5 m•kg, 47 ft•lb)	
Crankshaft position sensor	M6	2	10 Nm (1.0 m•kg, 7.2 ft•lb)	
Throttle position sensor	M5	1	3 Nm (0.3 m•kg, 2.2 ft•lb)	
Injector	M5	2	3 Nm (0.3 m•kg, 2.2 ft•lb)	
Ignition coil	M5	2	4 Nm (0.4 m•kg, 2.9 ft•lb)	
Coolant temperature sensor	M10	1	16 Nm (1.6 m•kg, 11 ft•lb)	
Rectifier/regulator	M6	2	7 Nm (0.7 m•kg, 5.1 ft•lb)	
Ignition coil bracket	M6	2	10 Nm (1.0 m•kg, 7.2 ft•lb)	
Intake air pressure sensor	M5	1	5 Nm (0.5 m•kg, 3.6 ft•lb)	
Atmospheric pressure sensor	M5	1	4 Nm (0.4 m•kg, 2.9 ft•lb)	
Atmospheric pressure sensor bracket	M6	1	7 Nm (0.7 m•kg, 5.1 ft•lb)	
Condenser bracket	M6	2	7 Nm (0.7 m•kg, 5.1 ft•lb)	
Ground lead	M5	1	4 Nm (0.4 m•kg, 2.9 ft•lb)	
△ ECU	M5	2	4 Nm (0.4 m•kg, 2.9 ft•lb)	
ECU bracket	M6	2	7 Nm (0.7 m•kg, 5.1 ft•lb)	

TIGHTENING TORQUES

GENERAL TORQUE SPECIFICATIONS

This chart specifies torque for standard fasteners with standard I.S.O. pitch threads. Torque specifications for special components or assemblies are included in the applicable sections of this book. To avoid warpage, tighten multi-fastener assemblies in a crisscross fashion, in progressive stages, until full torque is reached. Unless otherwise specified, torque specifications call for clean, dry threads. Components should be at room temperature.

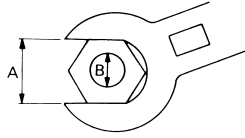

- A. Distance between flats
- B. Outside thread diameter

A (Nut)	B (Bolt)	TORQUE SPECIFICATION		
		Nm	m•kg	ft•lb
10 mm	6 mm	6	0.6	4.3
12 mm	8 mm	15	1.5	11
14 mm	10 mm	30	3.0	22
17 mm	12 mm	55	5.5	40
19 mm	14 mm	85	8.5	61
22 mm	16 mm	130	13	94

DEFINITION OF UNITS

Unit	Read	Definition	Measure
mm	millimeter	10^{-3} meter	Length
cm	centimeter	10^{-2} meter	Length
kg	kilogram	10^3 gram	Weight
N	Newton	$1 \text{ kg} \times \text{m}/\text{sec}^2$	Force
Nm	Newton meter	$\text{N} \times \text{m}$	Torque
m•kg	Meter kilogram	$\text{m} \times \text{kg}$	Torque
Pa	Pascal	N/m^2	Pressure
N/mm	Newton per millimeter	N/mm	Spring rate
L	Liter	—	Volume or capacity
cm ³	Cubic centimeter	—	Volume or capacity
r/min	Revolution per minute	—	Engine speed

LUBRICATION DIAGRAMS

LUBRICATION DIAGRAMS

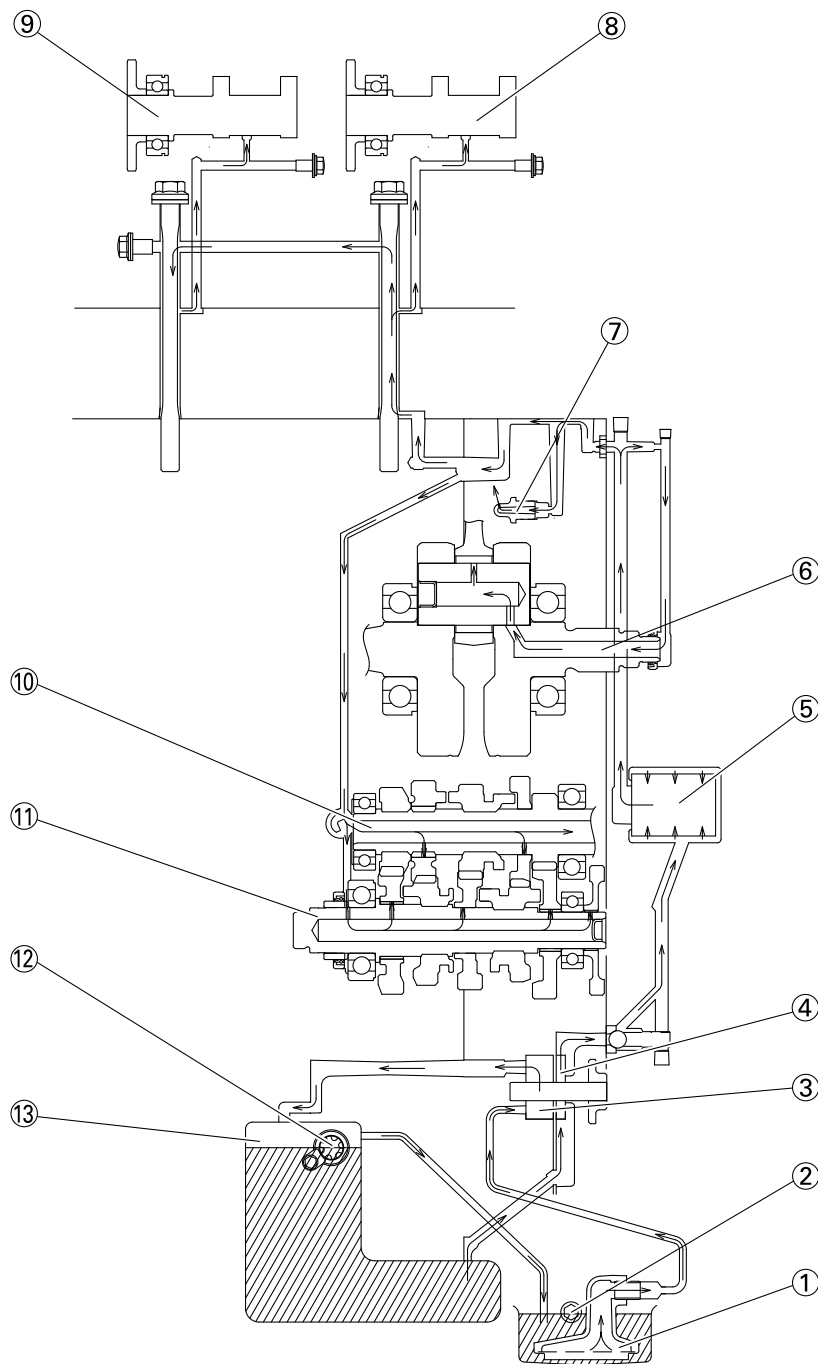

- | | |
|-----------------------|----------------------------|
| 1. Oil strainer | 10. Main axle |
| 2. Oil check bolt | 11. Drive axle |
| 3. Scavenging pump | 12. Oil level check window |
| 4. Oil feed pump | 13. Oil tank |
| 5. Oil filter element | |
| 6. Crankshaft | |
| 7. Oil nozzle | |
| 8. Exhaust camshaft | |
| 9. Intake camshaft | |

CABLE ROUTING DIAGRAM

CABLE ROUTING DIAGRAM

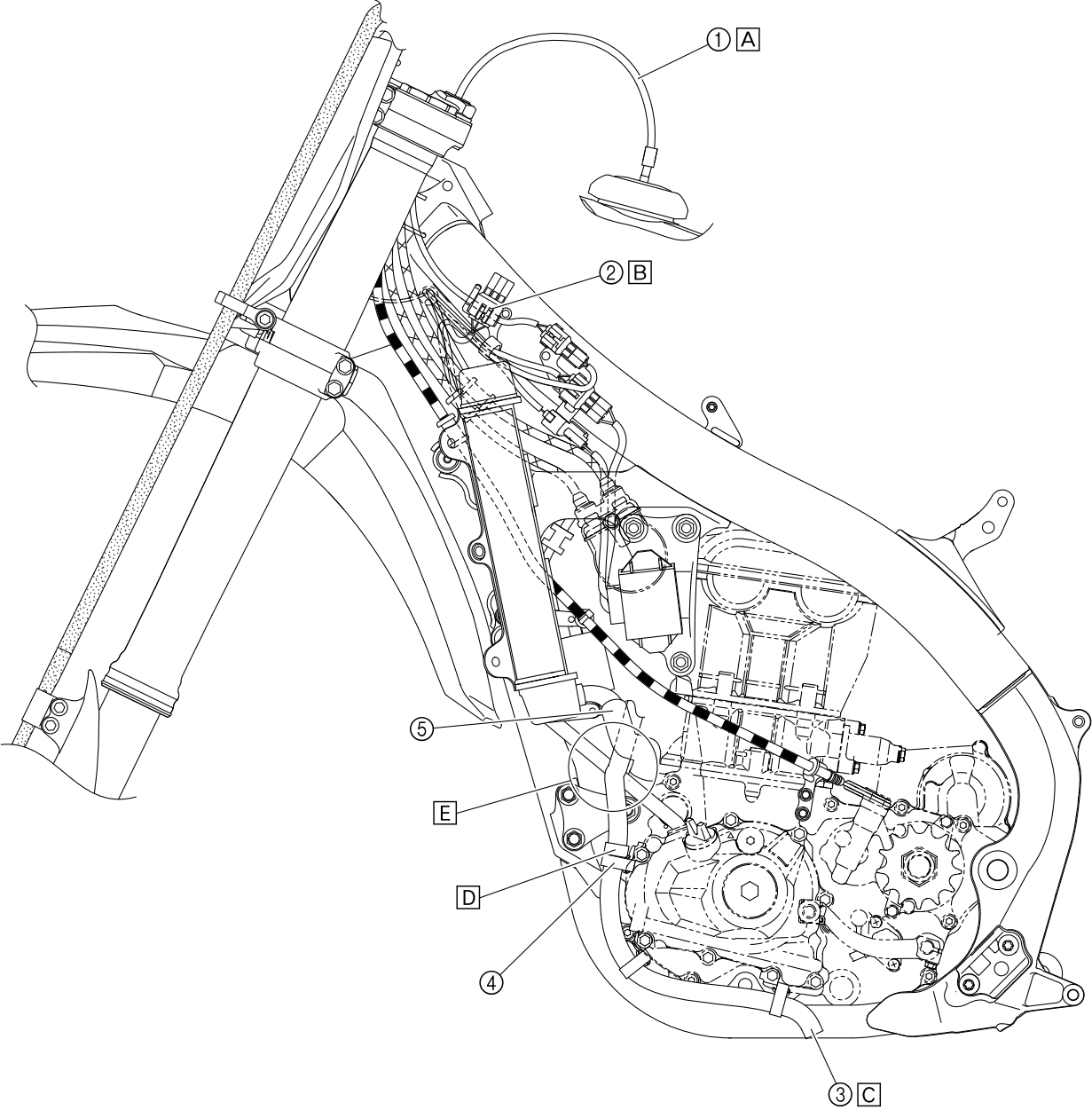

CABLE ROUTING DIAGRAM

1. Fuel tank breather hose
 2. Coupler for connecting optional part
 3. Cylinder head breather hose
 4. Hose holder
 5. Radiator hose 3
- A. Insert the end of the fuel tank breather hose into the hole in the steering stem.
 - B. Fit the accessory coupler into the connector to fasten it to the bracket.
 - C. Point the end of the cylinder head breather hose downward.
 - D. Pass the cylinder head breather hose through the hose holder, making sure that the stopper on the hose contacts the holder.
 - E. Route the cylinder head breather hose between the frame and radiator hose 3, and to the outside of the AC magneto lead.

CABLE ROUTING DIAGRAM

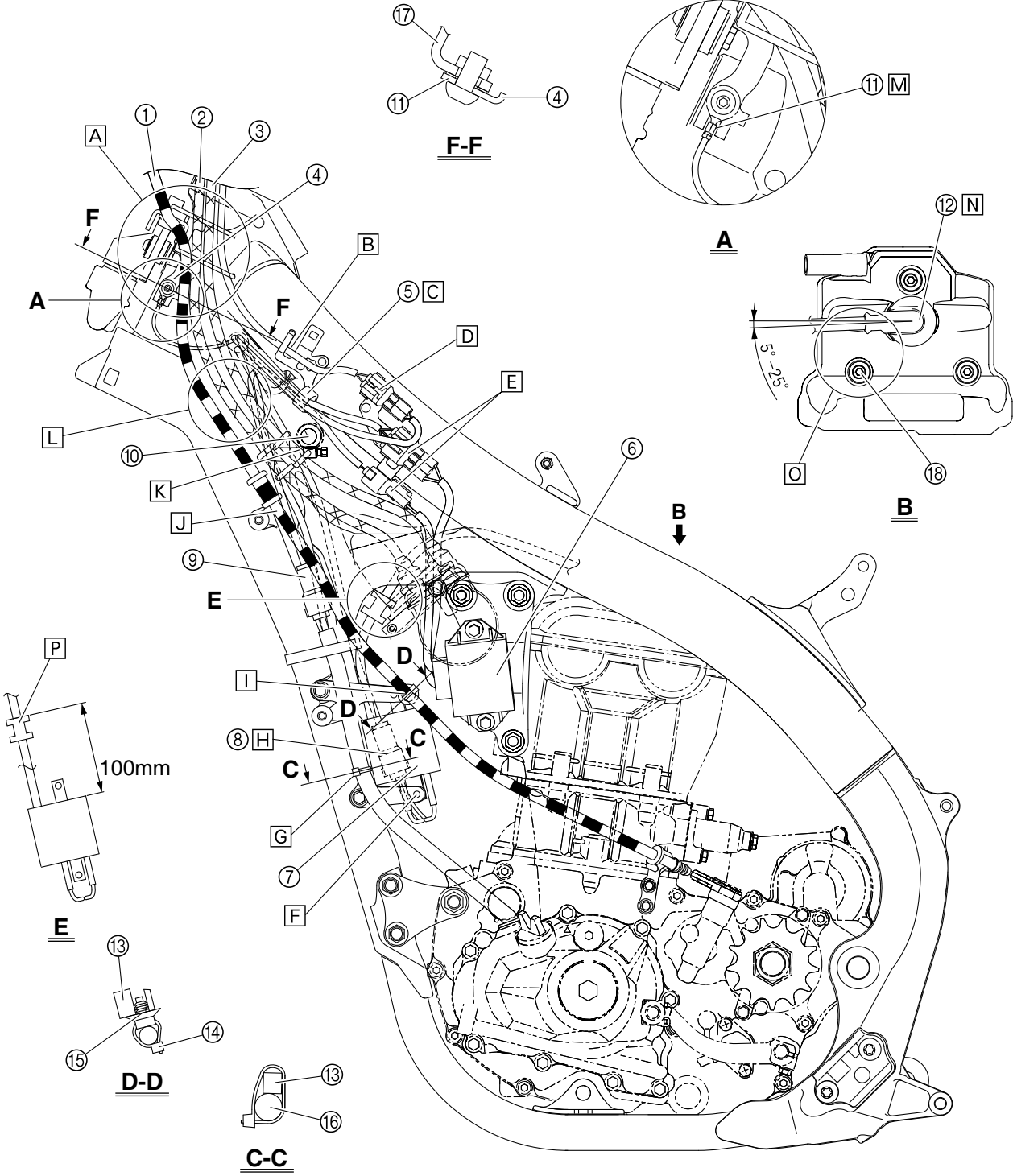

CABLE ROUTING DIAGRAM

1. Clutch cable
 2. Throttle cable (return)
 3. Throttle cable (pull)
 4. Cable holder
 5. Clamp
 6. Rectifier/regulator
 7. Ignition coil
 8. Ignition coil coupler
 9. AC magneto coupler
 10. Radiator hose 2
 11. Ground lead terminal
 12. Plug cap
 13. Ignition coil bracket
 14. Clamp (lock)
 15. Clamp (clip)
 16. AC magneto lead
 17. ECU bracket
 18. Cylinder head cover installing bolt
- A. Pass the clutch cable, throttle cables, and engine stop switch lead through the cable holder. Pass the clutch cable through the lower guide only.
 - B. Route the engine stop switch lead to the inside of the clip.
 - C. Fasten the rectifier/regulator lead and engine stop switch lead (wire harness end).
 - D. Insert the projection on the engine stop switch coupler into the hole in the bracket.
 - E. Insert the projection on the rectifier/regulator coupler into the hole in the bracket.
 - F. Position the ignition coil bracket to the outside of the ignition coil, and insert the bolts from the ignition coil side.
 - G. Fasten the AC magneto lead to the ignition coil bracket with a plastic locking tie, making sure to position the tie above the lower mounting portion of the bracket. Face the buckle of the plastic locking tie forward, and then cut off the excess end of the tie.
 - H. Route the ignition coil lead between the condenser and the ignition coil.
 - I. Fit the clip portion of the clamp into the ignition coil bracket and fasten the clutch cable with the locking portion of the clamp.
 - J. Route the clutch cable to the outside of the AC magneto lead.
 - K. Route the throttle cables under radiator hose 2, making sure not to twist the cables.
 - L. Route the AC magneto lead to the inside of the throttle cables and clutch cable.
 - M. Install the ground lead terminal between the ECU bracket and the cable holder, making sure to position the terminal between the stoppers.
 - N. Push in the spark plug cap completely, making sure that there is no gap between the cylinder head cover and the cap.
 - O. Pass the high tension cord so that it may not go right over the cylinder head cover installing bolt when viewed directly from above.
 - P. Apply sealant to the slit and inner surface of the grommet, and then install the grommet at the position shown.

CABLE ROUTING DIAGRAM

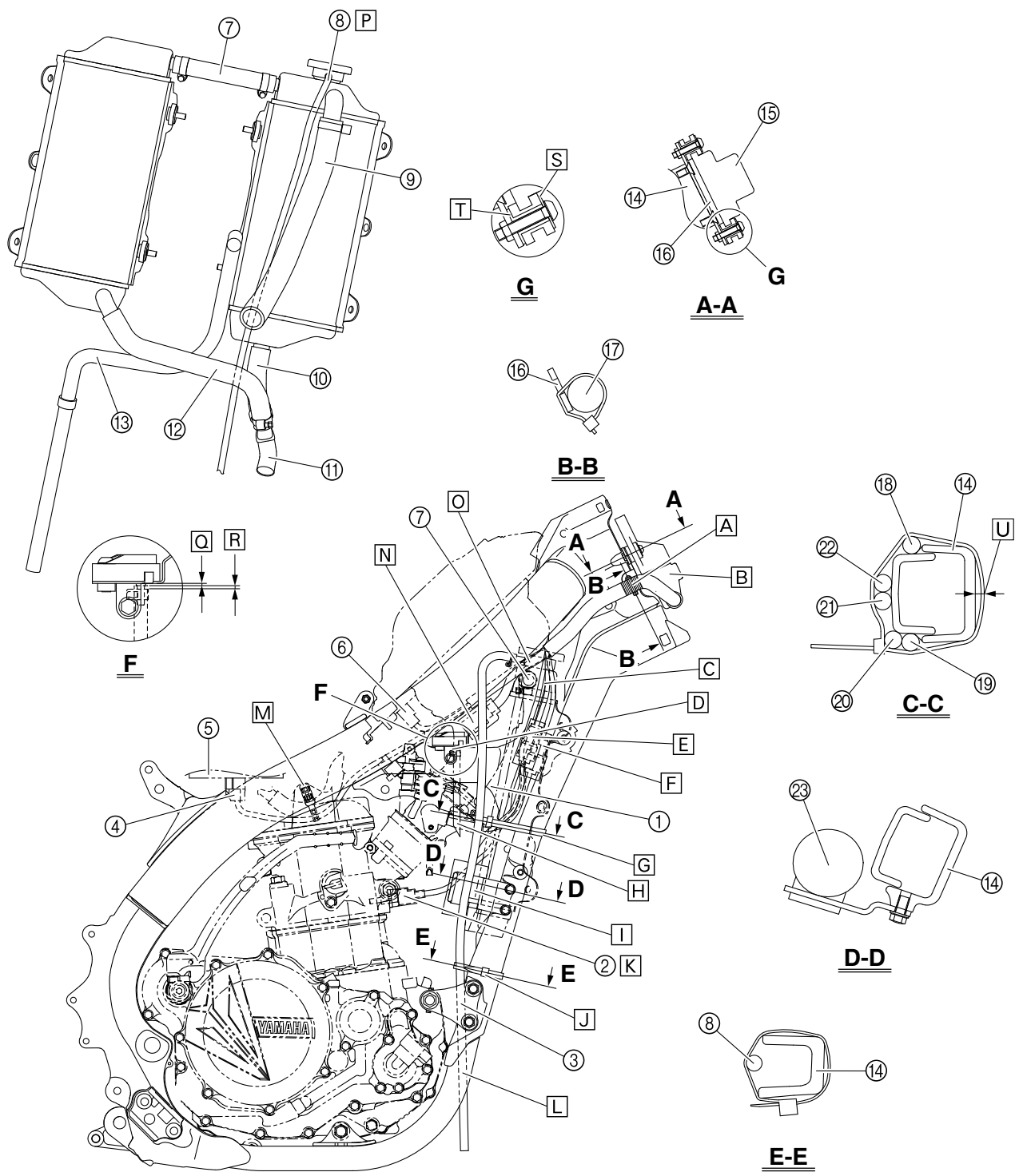

CABLE ROUTING DIAGRAM

-
- | | | |
|--|---|---|
| 1. Tension pipe | A. Fasten the wire harness at the positioning tape to the ECU bracket with a plastic locking tie. Face the buckle of the plastic locking tie downward, and then cut off the excess end of the tie. | L. Route the radiator breather hose between the down tubes. |
| 2. Coolant temperature sensor coupler | B. Install the cover onto the wire harness coupler. | M. Fasten the fuel hose and fuel pump lead with the plastic band, making sure to position the band between the bend in the fuel hose protector and the end of the protector. Point the end of the plastic band upward. |
| 3. Front engine bracket | C. Route the condenser lead, throttle position sensor lead, coolant temperature sensor lead, ignition coil lead, and AC magneto lead under radiator hose 2. | N. Insert the projection on the joint coupler into the hole in the bracket, and then install the coupler cover onto the coupler. |
| 4. Fuel pump coupler | D. Connect the vacuum hose to the atmospheric pressure sensor, and then fasten the hose with the clamp. Make sure to face the moving part of the sensor rearward. | O. Route the atmospheric pressure sensor lead, intake air pressure sensor lead, intake air temperature sensor lead, fuel injector lead, and fuel pump lead above radiator hose 2. Position the joint coupler above radiator hose 2. |
| 5. Fuel pump | E. After connecting the condenser coupler, install the coupler cover onto the coupler. | P. Route the radiator breather hose to the inside of radiator hose 1 and the front engine bracket. |
| 6. Intake air temperature sensor coupler | F. After connecting the throttle position sensor coupler, install the coupler cover onto the coupler. | Q. Hose installation position (1.3–3.3 mm, 0.05–0.13 in) |
| 7. Radiator hose 2 | G. Fasten the AC magneto lead, condenser lead, throttle position sensor lead, coolant temperature sensor lead, and ignition coil lead to the frame with the plastic band, making sure to position the band between the ignition coil bracket and the tension pipe. Face the buckle of the plastic band to the right with the end pointing rearward. | R. Clip installation position (0–2.0 mm, 0–0.08 in) |
| 8. Radiator breather hose | H. Point the end of the vacuum hose rearward. | S. Install the washer so that it contacts the bolt head. |
| 9. Radiator hose 1 | I. Fit the bracket into the hole in the rubber portion of the condenser. | T. Install the collar so that the flange on the collar contacts the ECU bracket. |
| 10. Radiator hose 4 | J. Fasten the radiator breather hose to the frame with the plastic band, making sure to position the band above the front engine bracket. Face the buckle of the plastic band outward with the end pointing rearward. | U. 6 mm (0.24 in) or less |
| 11. Radiator pipe 2 | K. After connecting the coolant temperature sensor coupler, install the coupler cover onto the coupler. | |
| 12. Radiator hose 3 | | |
| 13. Cylinder head breather hose | | |
| 14. Frame | | |
| 15. ECU (electronic control unit) | | |
| 16. ECU bracket | | |
| 17. Main harness | | |
| 18. AC magneto lead | | |
| 19. Throttle position sensor lead | | |
| 20. Condenser lead | | |
| 21. Coolant temperature sensor lead | | |
| 22. Ignition coil lead | | |
| 23. Condenser | | |

CABLE ROUTING DIAGRAM

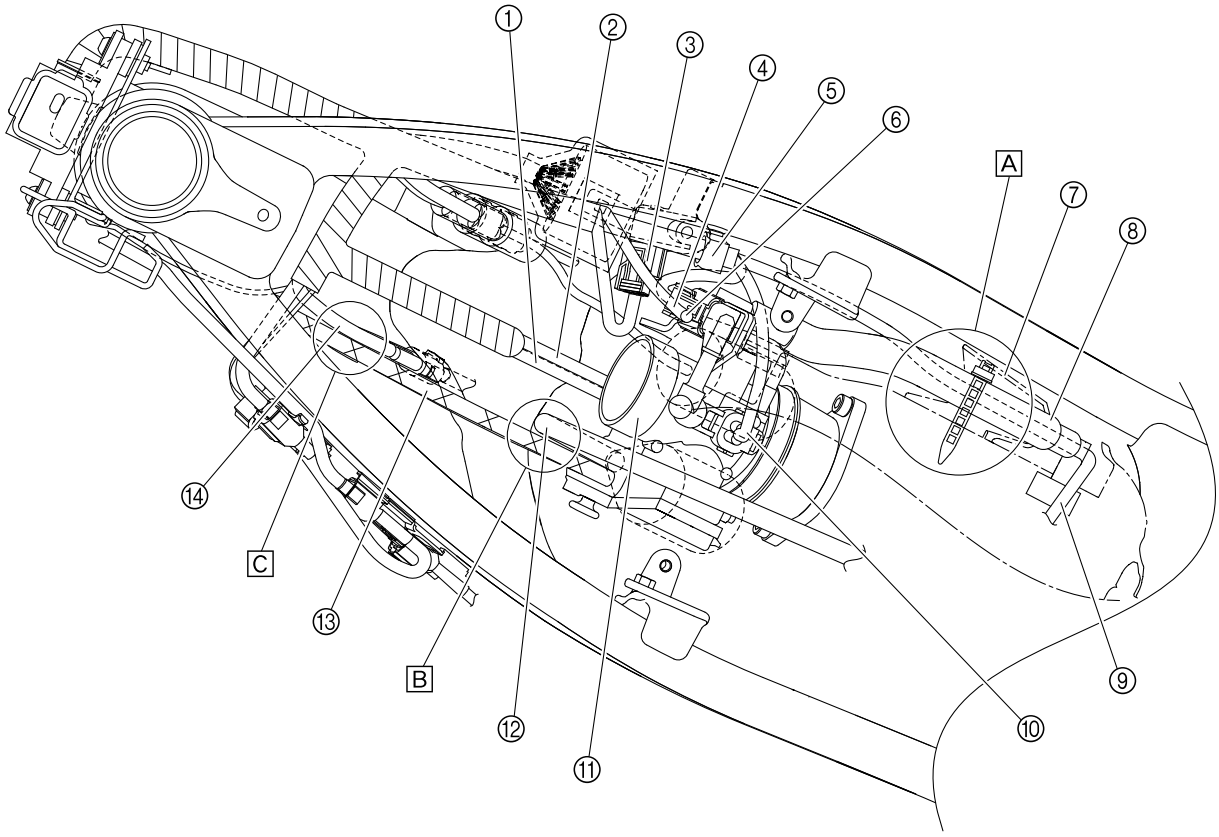

- 1. Ignition coil coupler
- 2. Coolant temperature sensor lead
- 3. Atmospheric pressure sensor coupler
- 4. Intake air temperature sensor lead
- 5. Clamp
- 6. Intake air pressure sensor coupler
- 7. Cover

- 8. Fuel hose
- 9. Fuel pump lead
- 10. Fuel injector coupler
- 11. Throttle body
- 12. High tension code
- 13. Throttle cable
- 14. AC magneto lead

- A. Route the fuel pump lead to the outside of the fuel hose and above the cover.
- B. Route the spark plug wire between the throttle cables and the throttle body. When installing the air filter, be sure not to pinch the spark plug wire.
- C. Route the AC magneto lead to the inside of the throttle cables.

CABLE ROUTING DIAGRAM

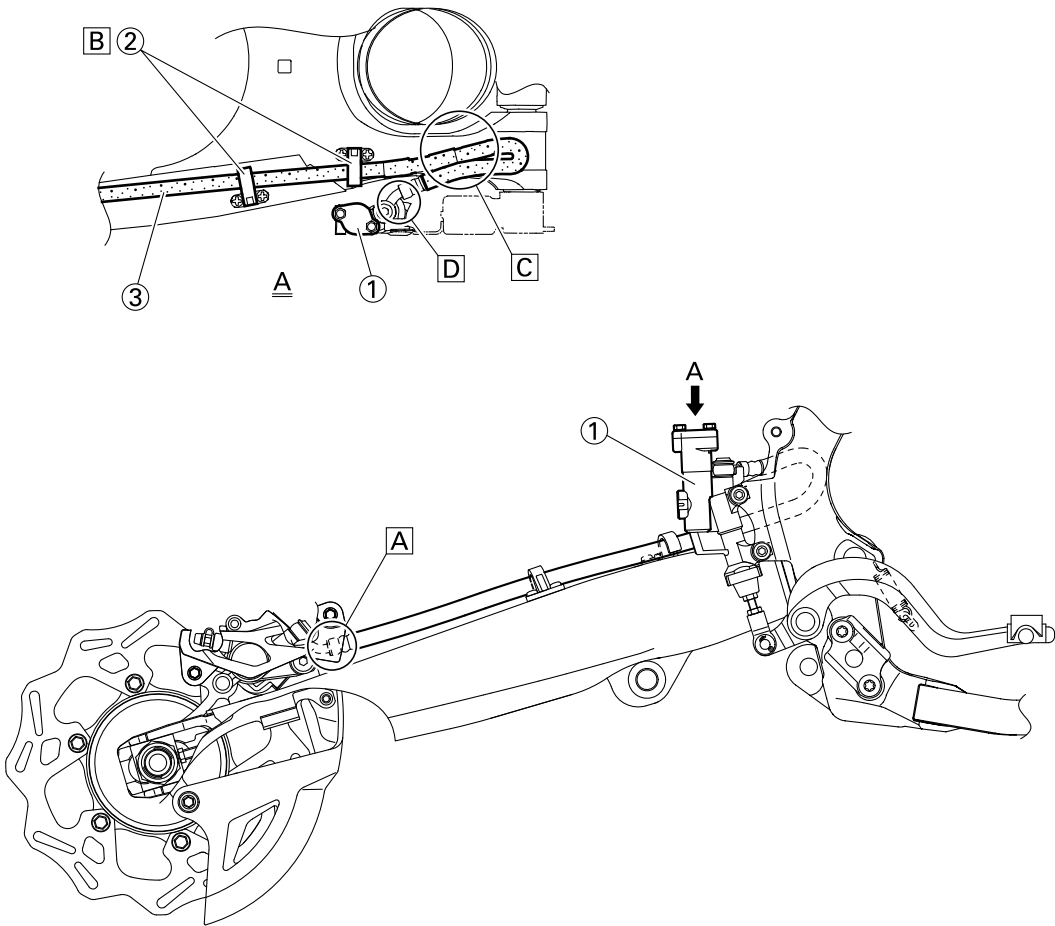

- 1. Brake master cylinder
- 2. Brake hose holder
- 3. Brake hose

- A. Install the brake hose so that its pipe portion directs as shown and lightly touches the projection on the brake caliper.
- B. Pass the brake hose into the brake hose holders.

- C. If the brake hose contacts the spring (rear shock absorber), correct its twist.
- D. Install the brake hose so that its pipe portion directs as shown and lightly touches the projection on the brake master cylinder.

CABLE ROUTING DIAGRAM

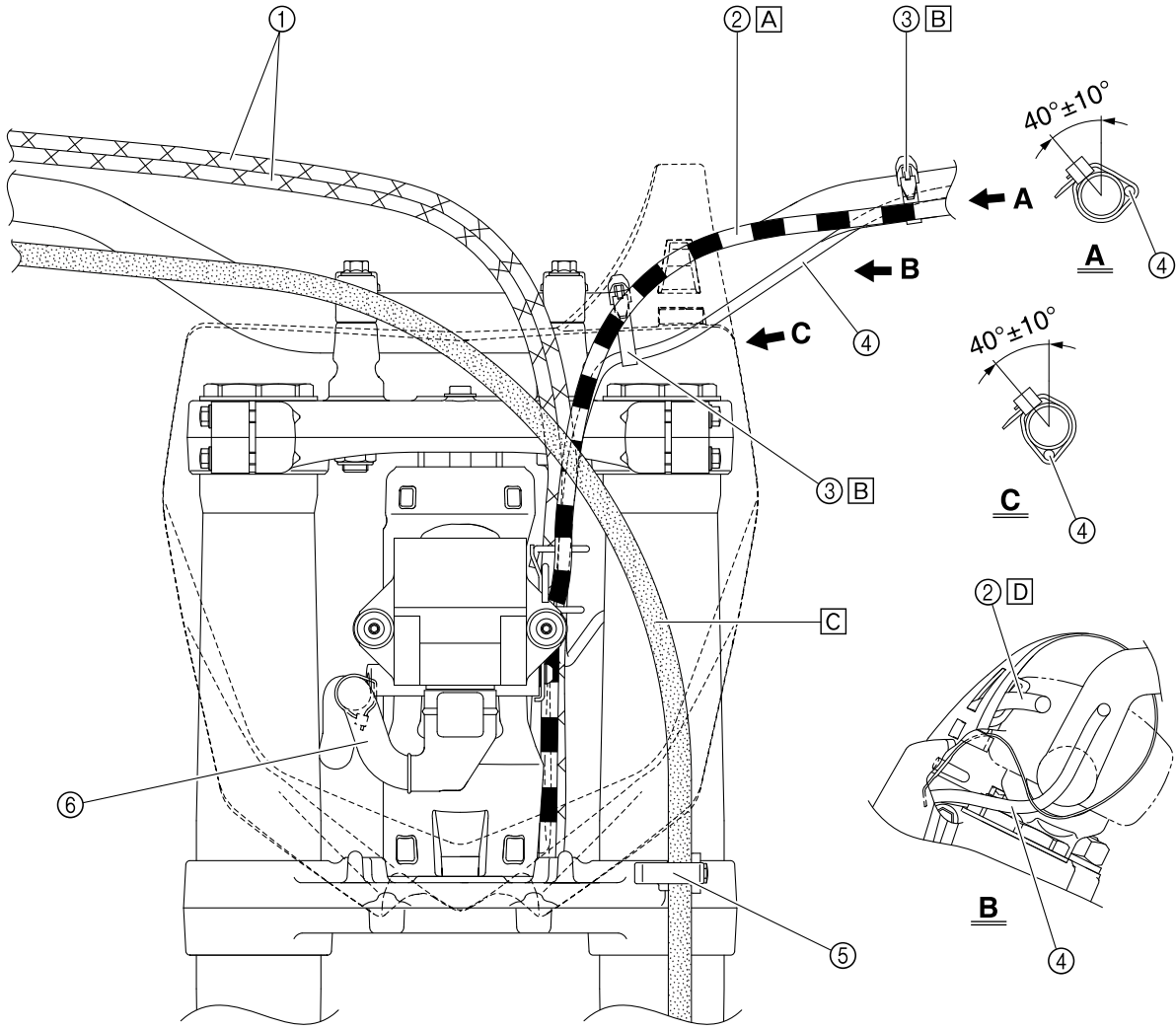

- 1. Throttle cable
- 2. Clutch cable
- 3. Clamp
- 4. Engine stop switch lead
- 5. Hose guide
- 6. Main harness

- A. Route the clutch cable to the rear of the number plate band.
- B. Fasten the engine stop switch lead to the handlebar.
- C. Route the brake hose to the front of the number plate.
- D. Pass the clutch cable through the cable guide on the number plate.

MAINTENANCE INTERVALS

REGULAR INSPECTION AND ADJUSTMENTS MAINTENANCE INTERVALS

TIP

- The following schedule is intended as a general guide to maintenance and lubrication. Bear in mind that such factors as weather, terrain, geographical location, and individual usage will alter the required maintenance and lubrication intervals. If you are a doubt as to what intervals to follow in maintaining and lubricating your machine, consult your Yamaha dealer.
- Periodic inspection is essential in making full use of the machine performance. The service life of the parts varies substantially according to the environment in which the machine runs (e.g., rain, dirt, etc.). Therefore, earlier inspection is required by reference to the list below..

Item	After break-in	Every race (about 2.5 hours)	Every third (about 7.5 hours)	Every fifth (about 12.5 hours)	As required	Remarks
ENGINE OIL Replace	●			●		
VALVES Check the valve clearances Inspect Replace	●		●	●	●	The engine must be cold. Check the valve seats and valve stems for wear.
VALVE SPRINGS Inspect Replace				●	●	Check the free length and the tilt.
VALVE LIFTERS Inspect Replace				●	●	Check for scratches and wear.
CAMSHAFTS Inspect Replace				●	●	Inspect the camshaft surface. Inspect the decompression system.
CAMSHAFT SPROCKETS Inspect Replace				●	●	Check for wear on the teeth and for damage.
PISTON Inspect Clean Replace				●	● ● ●	Inspect crack. Inspect carbon deposits and eliminate them. Replace the piston, piston pin, piston pin clip, and piston ring all as a set.
PISTON RING Inspect Replace				●	● ●	Check ring end gap. Replace the piston, piston pin, piston pin clip, and piston ring all as a set.
PISTON PIN Inspect Replace				●	● ●	Replace the piston, piston pin, piston pin clip, and piston ring all as a set.

MAINTENANCE INTERVALS

Item	After break-in	Every race (about 2.5 hours)	Every third (about 7.5 hours)	Every fifth (about 12.5 hours)	As required	Remarks
CYLINDER HEAD Inspect and clean				●		Inspect carbon deposits and eliminate them. Change gasket.
CYLINDER Inspect and clean Replace				●	●	Inspect score marks. Inspect wear.
CLUTCH Inspect and adjust Replace	●	●			●	Inspect housing, friction plate, clutch plate and spring.
TRANSMISSION Inspect Replace bearing					● ●	
SHIFT FORK, SHIFT CAM, GUIDE BAR Inspect					●	Inspect wear.
ROTOR NUT Retighten	●			●		
EXHAUST PIPE, SILENCER, PROTECTOR Inspect and retighten Clean Replace filter	●	●	●	●	● *	* When the exhaust sound becomes louder or when a performance drop is felt.
CRANK Inspect and clean				●	●	
THROTTLE BODY Inspect					●	
SPARK PLUG Inspect and clean Replace	●		●		●	
DRIVE CHAIN Lubricate, slack, alignment Replace	●	●			●	Use chain lube. Chain slack: 50–60 mm (2.0–2.4 in)
COOLING SYSTEM Check coolant level and leakage Check radiator cap operation Replace coolant Inspect hoses	●	●			● ●	Every two years
OUTSIDE NUTS AND BOLTS Retighten	●	●				Refer to "STARTING AND BREAK-IN" section in the CHAPTER 1.

MAINTENANCE INTERVALS

Item	After break-in	Every race (about 2.5 hours)	Every third (about 7.5 hours)	Every fifth (about 12.5 hours)	As required	Remarks
AIR FILTER Clean and lubricate Replace	●	●			●	Use foam air-filter oil or equivalent oil.
OIL FILTER Replace	●			●		
ENGINE GUARD Replace					●	Breakage
FRAME Clean and inspect	●	●				
FUEL TANK, FUEL PUMP inspect	●		●			
FUEL HOSE Inspect Replace					● ●	Every four years
BRAKES Adjust lever position and pedal height Lubricate pivot point Check brake disc surface Check fluid level and leakage Retighten brake disc bolts, caliper bolts, master cylinder bolts and union bolts Replace pads Replace brake fluid	● ● ● ● ●	● ● ● ● ●			● ●	Every one year
FRONT FORKS Inspect and adjust Replace oil Replace oil seal	● ●	●		●	●	Suspension oil "S1"
FRONT FORK OIL SEAL AND DUST SEAL Clean and lube	●	●				Lithium base grease
PROTECTOR GUIDE Replace					●	
REAR SHOCK ABSORBER Inspect and adjust Lube Retighten	● ●	● ●		●	(After rain ride) ●	Molybdenum disulfide grease
DRIVE CHAIN GUIDE AND ROLLERS Inspect	●	●				

MAINTENANCE INTERVALS

Item	After break- in	Every race (about 2.5 hours)	Every third (about 7.5 hours)	Every fifth (about 12.5 hours)	As re- quired	Remarks
SWINGARM Inspect, lube and retighten	●	●				Molybdenum disulfide grease
RELAY ARM, CONNECTING ROD Inspect, lube and retighten	●	●				Molybdenum disulfide grease
STEERING HEAD Inspect free play and retighten Clean and lube Replace bearing	●	●		●	●	Lithium base grease
TIRE, WHEELS Inspect air pressure, wheel run- out, tire wear and spoke loose- ness Retighten sprocket bolt Inspect bearings Replace bearings Lubricate	●	●	●		●	Lithium base grease
THROTTLE, CONTROL CABLE Check routing and connection Lubricate	●	●				Yamaha cable lube or SAE 10W-40 motor oil

PRE-OPERATION INSPECTION AND MAINTENANCE

PRE-OPERATION INSPECTION AND MAINTENANCE

Before riding for break-in operation, practice or a race, make sure the machine is in good operating condition.

Before using this machine, check the following points.

GENERAL INSPECTION AND MAINTENANCE

Item	Routine	Page
Coolant	Check that coolant is filled up to the radiator cap. Check the cooling system for leakage.	P.3-6 – 7
Fuel	Check that a fresh gasoline is filled in the fuel tank. Check the fuel line for leakage.	P.1-17
Engine oil	Check that the oil level is correct. Check the crankcase and oil line for leakage.	P.3-9 – 10
Gear shifter and clutch	Check that gears can be shifted correctly in order and that the clutch operates smoothly.	P.3-7
Throttle grip/Housing	Check that the throttle grip operation and free play are correctly adjusted. Lubricate the throttle grip and housing, if necessary.	P.3-8
Brakes	Check the play of front brake and effect of front and rear brake.	P.3-14 – 17
Drive chain	Check drive chain slack and alignment. Check that the drive chain is lubricated properly.	P.3-17 – 18
Wheels	Check for excessive wear and tire pressure. Check for loose spokes and have no excessive play.	P.3-21
Steering	Check that the handlebar can be turned smoothly and have no excessive play.	P.3-21 – 22
Front forks and rear shock absorber	Check that they operate smoothly and there is no oil leakage.	P.3-18 – 20
Cables (wires)	Check that the clutch and throttle cables move smoothly. Check that they are not caught when the handlebars are turned or when the front forks travel up and down.	—
Exhaust pipe	Check that the exhaust pipe is tightly mounted and has no cracks.	P.4-3 – 4
Rear wheel sprocket	Check that the rear wheel sprocket tightening bolt is not loose.	P.3-17
Lubrication	Check for smooth operation. Lubricate if necessary.	P.3-23
Bolts and nuts	Check the chassis and engine for loose bolts and nuts.	P.1-19
Lead connectors	Check that the AC magneto, ECU and ignition coil are connected tightly.	P.1-10 – 11
Settings	Is the machine set suitably for the condition of the racing course and weather or by taking into account the results of test runs before racing? Are inspection and maintenance completely done?	P.8-1 – 5

ENGINE

CHECKING THE COOLANT LEVEL

⚠ WARNING

Do not remove the radiator cap "1", drain bolt and hoses when the engine and radiator are hot. Scalding hot fluid and steam may be blown out under pressure, which could cause serious injury. When the engine has cooled, place a thick towel over the radiator cap, slowly rotate the cap counterclockwise to the detent. This procedure allows any residual pressure to escape. When the hissing sound has stopped, press down on the cap while turning counterclockwise and remove it.

NOTICE

Hard water or salt water is harmful to the engine parts. You may use distilled water, if you can't get soft water.

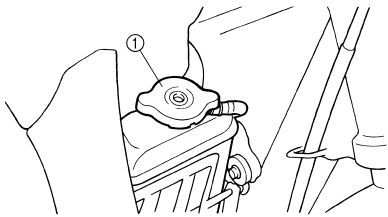

- Place the machine on a level place, and hold it in an upright position.
- Remove:
 - Radiator cap
- Check:
 - Coolant level "a"

Coolant level low → Add coolant.

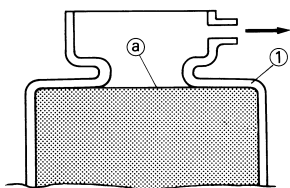

1. Radiator

CHANGING THE COOLANT

⚠ WARNING

Do not remove the radiator cap when the engine is hot.

NOTICE

Take care so that coolant does not splash on painted surfaces. If it splashes, wash it away with water.

- Place a container under the engine.
- Remove:
 - Coolant drain bolt "1"

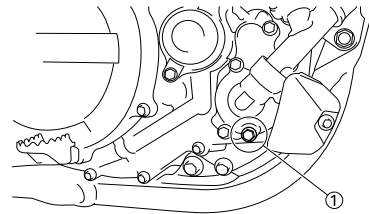

- Remove:
 - Radiator cap

Drain the coolant completely.
- Clean:
 - Cooling system

Thoroughly flush the cooling system with clean tap water.
- Install:
 - Copper washer **New**
 - Coolant drain bolt

	Coolant drain bolt: 10 Nm (1.0 m•kg, 7.2 ft•lb)
---	---

- Fill:
 - Radiator
 - Engine

To specified level.

	Recommended coolant: High quality ethylene glycol anti-freeze containing anti-corrosion for aluminum engine Coolant "1" and water (soft water) "2" mixing ratio: 50%/50% Coolant capacity: 1.13 L (0.99 Imp qt, 1.19 US qt)
---	---

NOTICE

- Do not mix more than one type of ethylene glycol antifreeze containing corrosion inhibitors for aluminum engine.
- Do not use water containing impurities or oil.

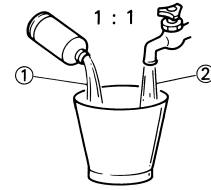

323-020

Handling notes of coolant:

The coolant is harmful so it should be handled with special care.

⚠ WARNING

- When coolant splashes to your eye.
Thoroughly wash your eye with water and see your doctor.
- When coolant splashes to your clothes.
Quickly wash it away with water and then with soap.
- When coolant is swallowed.
Quickly make him vomit and take him to a doctor.



- Install:
 - Radiator cap

Start the engine and warm it up for a several minutes.
- Check:
 - Coolant level

Coolant level low → Add coolant.

CHECKING THE RADIATOR CAP

- Inspect:
 - Seal (radiator cap) "1"
 - Valve and valve seat "2"

Crack/damage → Replace.
Exist fur deposits "3" → Clean or replace.

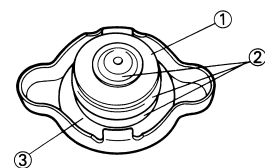

CHECKING THE RADIATOR CAP OPENING PRESSURE

- Attach:
 - Radiator cap tester "1" and adapter "2"

	Radiator cap tester: YU-24460-01/90890-01325
	Radiator cap tester adapter: YU-33984/90890-01352

TIP
Apply water on the radiator cap seal.

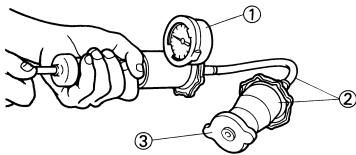

- Radiator cap
- Apply the specified pressure.

	Radiator cap opening pressure: 108–137 kPa (1.08–1.37 kg/cm ² , 15.4–19.5 psi)
--	---

- Inspect:
 - Pressure
Impossible to maintain the specified pressure for 10 seconds → Replace.

CHECKING THE COOLING SYSTEM

- Inspect:
 - Coolant level
- Attach:
 - Radiator cap tester "1" and adapter "2"

	Radiator cap tester: YU-24460-01/90890-01325
	Radiator cap tester adapter: YU-33984/90890-01352

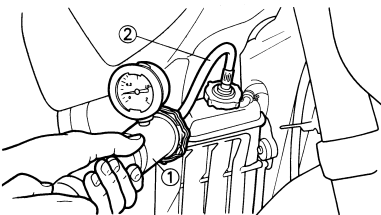

- Apply the specified pressure.

	Standard pressure: 196 kPa (1.96 kg/cm ² , 27.9 psi)
---	---

- TIP**
- Do not apply pressure more than specified pressure.
 - Radiator should be filled fully.

- Inspect:
 - Pressure
Impossible to maintain the specified pressure for 10 seconds → Repair.
 - Radiator
 - Radiator hose joint
Coolant leakage → Repair or replace.
 - Radiator hose
Swelling → Replace.

ADJUSTING THE CLUTCH LEVER POSITION

- Adjust:
 - Clutch lever position

Clutch lever position adjustment steps:

- Loosen the locknuts "1".
- Turn the adjusting bolt "2" until the clutch lever position "a" is in the desired position.

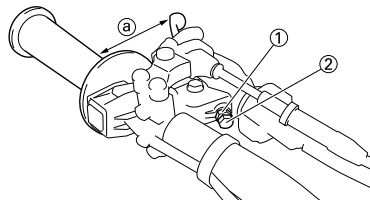

- Tighten the locknuts.

	Locknut: 5 Nm (0.5 m•kg, 3.6 ft•lb)
---	---

- Adjust:
 - Clutch cable free play
Refer to "ADJUSTING THE CLUTCH CABLE FREE PLAY".

ADJUSTING THE CLUTCH CABLE FREE PLAY

- Check:
 - Clutch lever free play "a"
Out of specification → Adjust.

	Clutch lever free play "a" : 7–12 mm (0.28–0.47 in)
---	--

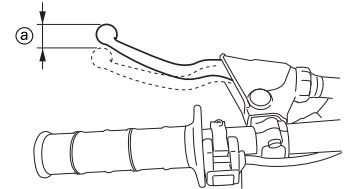

- Adjust:
 - Clutch lever free play

Clutch lever free play adjustment steps:

- Loosen the locknuts "1".
- Turn the adjuster "2" until free play "a" is within the specified limits.
- Tighten the locknuts.

	Locknut: 4 Nm (0.4 m•kg, 2.9 ft•lb)
---	---

TIP

- Before adjustment, expose the adjuster by moving the boot "3" and cap "4" away.
- Make minute adjustment on the lever side using the adjuster "5".
- After adjustment, check proper operation of clutch lever.

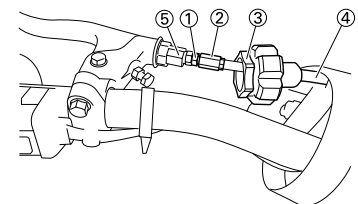

- Install:
 - Cap "1"
 - Boot "2"

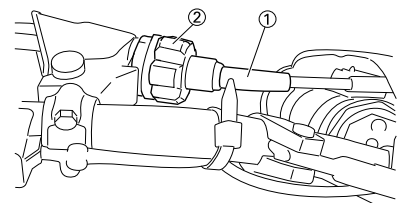

ADJUSTING THE THROTTLE GRIP FREE PLAY

1. Check:
 - Throttle grip free play "a"
 - Out of specification → Adjust.

	Throttle grip free play "a": 3–5 mm (0.12–0.20 in)
---	---

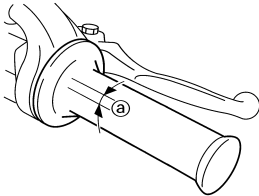

2. Adjust:
 - Throttle grip free play



Adjustment steps:

- a. Slide the adjuster cover.
- b. Loosen the locknut "1".
- c. Turn the adjuster "2" until the specified free play is obtained.
- d. Tighten the locknut.

TIP

Prior to adjusting throttle grip free play, the engine idling speed should be adjusted.

⚠ WARNING

After adjusting the throttle grip free play, turn the handlebar to the right and to the left to ensure that this does not cause the engine idling speed to change.

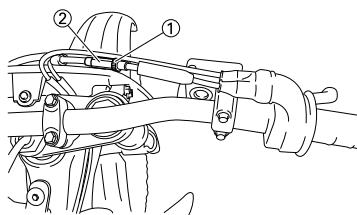

LUBRICATING THE THROTTLE

1. Remove:
 - Cover (throttle cable cap) "1"
 - Cover (grip cap) "2"
 - Throttle grip cap "3"

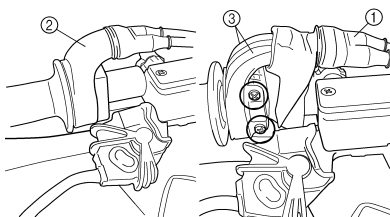

2. Apply:
 - Lithium soap base grease
 - On the throttle cable end "a".

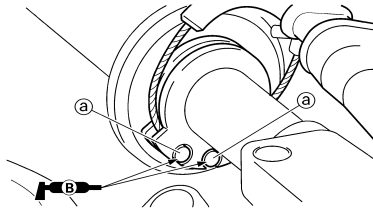

3. Install:
 - Throttle grip cap
 - Screw (throttle grip cap)

	Screw (throttle grip cap): 4 Nm (0.4 m•kg, 2.9 ft•lb)
---	--

- Cover (grip cap)
- Cover (throttle cable cap)

CHECKING THE THROTTLE VALVE PULLEY COVER DRAIN HOSE

TIP

Drain the water that stays in the throttle valve pulley cover after a machine wash or a rainy weather ride.

1. Drain the water by picking up the flat portion of the lower end "a" of the drain hose.

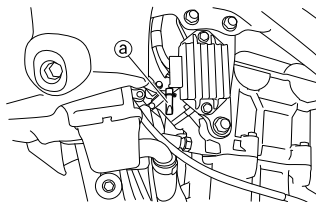

CLEANING THE AIR FILTER ELEMENT

1. Remove:
 - Seat
2. Remove the fuel tank bolt (front) "1" and lift the fuel tank.

TIP

Hold the fuel tank in position by the use of the fuel tank holding cable "2".

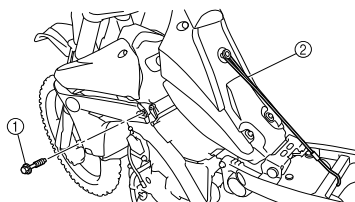

3. Remove:
 - Mounting bolt for air filter case cover

4. Loosen and release the binder "1" and lift the air filter case lid.

TIP

Hold the air filter case lid by the use of the binder.

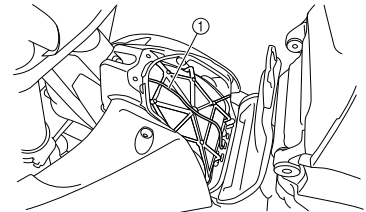

5. Remove:
 - Air filter guide
 - Air filter element "1"

NOTICE

Do not remove the thin sheet (air filter element 2) "2" under the air filter element unless it is dirty. It is there to prevent foreign matter from dropping into the throttle body. If the thin sheet must be removed for cleaning, lift it carefully to avoid loosening the dirt, and then temporarily block the throttle body opening with a clean, lint-free cloth.

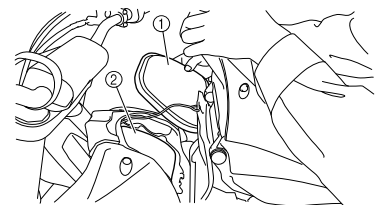

6. Clean:
 - Air filter element

Clean them with solvent.

TIP

After cleaning, remove the remaining solvent by squeezing the element.

NOTICE

- Do not twist the element when squeezing the element.
- Leaving too much of solvent in the element may result in poor starting.

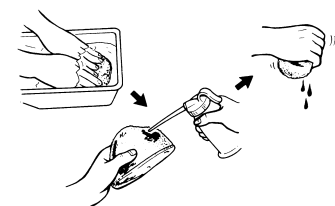

7. Inspect:
 - Air filter element

Damage → Replace.

8. Apply:
- Foam-air-filter oil or equivalent oil to the element



Oil application quantify:
35 g

TIP

Squeeze out the excess oil. Element should be wet but not dripping.

9. If the thin sheet (air filter element 2) is dirty with mud etc., clean the thin sheet (air filter element 2) by the following steps.

Cleaning steps:

- a. Remove the air filter element 2 "1".

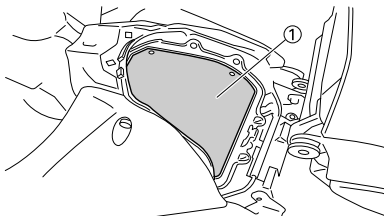

- b. Clean the air filter element 2 with solvent.

TIP

After cleaning, remove the remaining solvent by squeezing the element.

NOTICE

Do not twist the element when squeezing the element.

- c. Inspect the air filter element 2. Damage → Replace.
d. Install the air filter element 2.

10. Install:

- Air filter element "1"
- Air filter guide "2"
- Binder

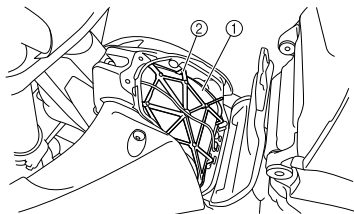

11. Install:

- Mounting bolt for air filter case cover



Mounting bolt for air filter case cover:
5 Nm (0.5 m•kg, 3.6 ft•lb)

12. Install:

- Fuel tank bolt (front)



Fuel tank bolt (front):
9 Nm (0.9 m•kg, 6.5 ft•lb)

CHECKING THE THROTTLE BODY JOINT

1. Remove:

- Seat
- Air scoop (left/right)
- Fuel tank
- Air filter

2. Check:

- Throttle body joint "1"
Cracks/damage → Replace.

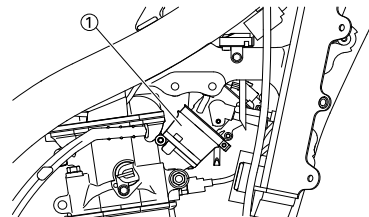

3. Install:

- Air filter
- Fuel tank
- Air scoop (left/right)
- Seat

CHECKING THE FUEL LINE

1. Remove:

- Seat
- Fuel tank
- Air scoop (left/right)
- Air filter case
- Cover

2. Check:

- Fuel hose "1"
Cracks/damage → Replace.
Loose connection → Reconnect.

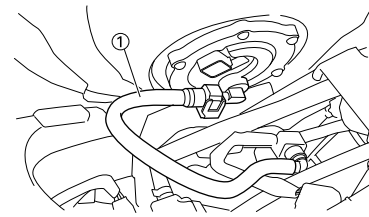

3. Install:

- Cover
- Air filter case
- Air scoop (left/right)
- Fuel tank
- Seat

CHECKING THE ENGINE OIL LEVEL

1. Stand the machine on a level surface.

TIP

- When checking the oil level make sure that the machine is upright.
- Place the machine on a suitable stand.

2. Start the engine, warm it up for 2–3 minutes at engine idling speed, and then stop the engine and wait approximately 1 minute.

3. Inspect:

- Oil level

Make sure that the engine oil level is between the maximum level line "a" and minimum level line "b" shown for the oil level check window.

Above the upper limit "a" → Check that no oil comes out when the check bolt "1" for the oil quantity upper limit is removed.

If any engine oil comes out, drain it until its last drop is out.

Below the level mark "b" → Add sufficient oil and idle run the engine, and after stopping the engine, recheck through the oil inspection window that the oil is at the specified level.

TIP

- Check the oil quantity within 5 minutes after the engine is shut off. Over 5 minutes, idle the engine again and recheck the oil quantity.
- Do not leave the check bolt for the oil quantity upper limit removed. Otherwise, the oil level drops with time in the engine, allowing the oil to flow out.

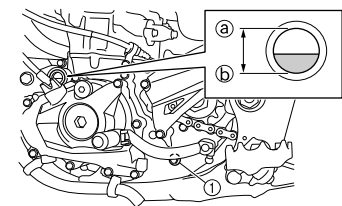

NOTICE

- Engine oil also lubricates the clutch and the wrong oil types or additives could cause clutch slippage. Therefore, do not add any chemical additives or use engine oils with a grade of CD or higher and do not use oils labeled "ENERGY CONSERVING II".
- Do not allow foreign material to enter the crankcase.



Recommended brand:
YAMALUBE
Recommended engine oil type
SAE10W-30, SAE 10W-40, SAE10W-50, SAE 15W-40, SAE 20W-40 or SAE 20W-50
Recommended engine oil grade
API service SG type or higher, JASO standard MA

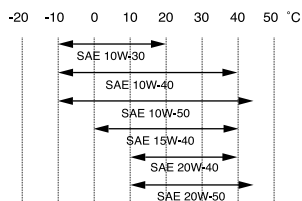

CHANGING THE ENGINE OIL

- Start the engine and let it warm up for several minutes.
- Stop the engine and place an oil pan under the drain bolt.
- Remove:
 - Oil filler cap "1"
 - Drain bolt (with gasket) "2"
 - Drain bolt (with gasket) "3"
 Drain the engine oil.

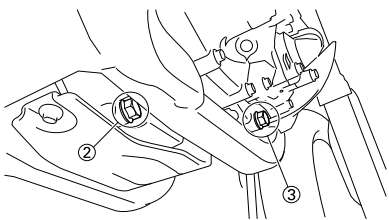
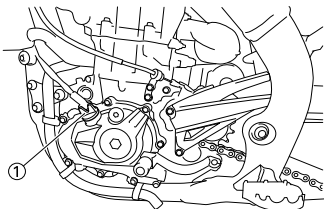

- If the oil filter is to be replaced during this oil change, remove the following parts and reinstall them.

Replacement steps:

- Remove the oil filter element cover "1" and oil filter element "2".
- Check the O-rings "3", if cracked or damaged, replace them with a new one.
- Install the oil filter element and oil filter element cover.



Oil filter element cover:
10 Nm (1.0 m•kg, 7.2 ft•lb)

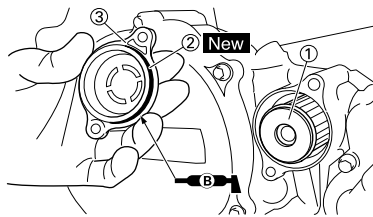

- Install:
 - Gaskets **New**
 - Oil drain bolt (oil pan)



Oil drain bolt (oil pan):
20 Nm (2.0 m•kg, 14 ft•lb)

- Oil drain bolt (oil tank)



Oil drain bolt (oil tank):
20 Nm (2.0 m•kg, 14 ft•lb)

- Fill:
 - Engine oil



Oil quantity:
Periodic oil change:
0.95 L (0.84 Imp qt, 1.00 US qt)
With oil filter replacement:
1.0 L (0.88 Imp qt, 1.06 US qt)
Total amount:
1.2 L (1.06 Imp qt, 1.27 US qt)

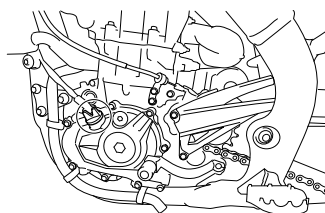

- Install:
 - Oil filler cap
- Inspect:
 - Engine (for oil leaks)
 - Oil level

CHECKING THE OIL PRESSURE

- Check:
 - Oil pressure

Checking steps:

- Slightly loosen the oil pressure check bolt "1".
- Start the engine and keep it idling until oil starts to seep from the oil pressure check bolt. If no oil comes out after one minute, turn the engine off so it will not seize.
- Check oil passages and oil pump for damage or leakage.
- Start the engine after solving the problem(s) and recheck the oil pressure.
- Tighten the oil pressure check bolt.



Oil pressure check bolt:
10 Nm (1.0 m•kg, 7.2 ft•lb)

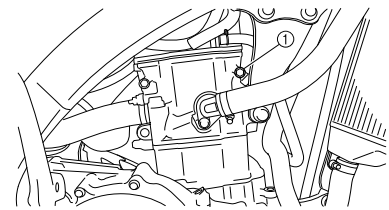

ADJUSTING THE ENGINE IDLING SPEED

TIP

- Because the air pressure is lower at high altitudes, the air-fuel mixture will become richer. If the engine idling speed is low, turn the starter (choke) knob/idling screw a few clicks counterclockwise to increase the idling speed.
- Before adjusting the engine idling speed, make sure that the compression pressure is within specification and that the air filter element is not clogged.
- Adjust the engine idling speed with the starter (choke) knob/idling screw pushed in completely.

- Start the engine and warm it up until the engine oil has reached the specified temperature.
- Use a temperature probe tester "1" and contact it to the drain bolt thread.



Oil temperature:
55.0–65.0 °C
(131–149°F)

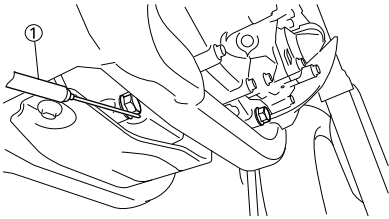

3. Adjust:
- Engine idling speed



Adjustment steps:

- a. Turn the starter knob/idle screw "1" until the specified engine idling speed is obtained.

TIP

Using the digital tachometer, measure the engine speed with the detector "c" pinched in the high tension cord "2" of the ignition coil.

	Digital tachometer: YU-39951-B/90890-06760
---	--

To increase the engine idling speed → Turn the starter (choke) knob/idling screw counterclockwise "a".	
To decrease the engine idling speed → Turn the starter (choke) knob/idling screw clockwise "b".	

	Engine idling speed: 1,900–2,100 r/min
---	--

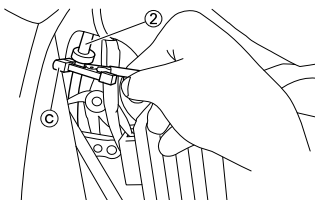
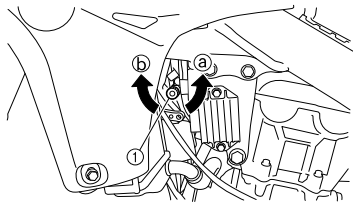

ADJUSTING THE VALVE CLEARANCE

TIP

- This section is intended for those who have basic knowledge and skill concerning the servicing of Yamaha motorcycles (e.g., Yamaha dealers, service engineers, etc.) Those who have little knowledge and skill concerning servicing are requested not to undertake inspection, adjustment, disassembly, or reassembly only by reference to this manual. It may lead to servicing trouble and mechanical damage.
- The valve clearance should be adjusted when the engine is cool to the touch.

1. Remove:

- Seat
Refer to "SEAT AND SIDE COVERS" section in the CHAPTER 4.
- Fuel tank
Refer to "FUEL TANK" section in the CHAPTER 6.

2. Remove:

- Spark plug
- Cylinder head cover
Refer to "CAMSHAFTS" section in the CHAPTER 4.

3. Remove:

- Timing mark accessing screw "1"
- Crankshaft end accessing screw "2"
- O-ring

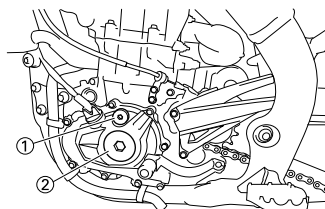

4. Check:

- Valve clearance
Out of specification → Adjust.

	Valve clearance (cold): Intake valve: 0.10–0.15 mm (0.0039–0.0059 in) Exhaust valve: 0.20–0.25 mm (0.0079–0.0098 in)
---	---



Checking steps:

- a. Turn the crankshaft counterclockwise with a wrench.
- b. Align the alignment mark "a" on the rotor with the alignment mark "b" on the crankcase cover.

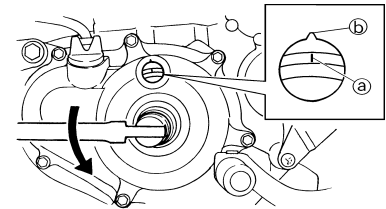

TIP

Make sure that the alignment mark "c" on the exhaust camshaft sprocket and the alignment mark "d" on the intake camshaft sprocket are aligned with the edge of the cylinder head.

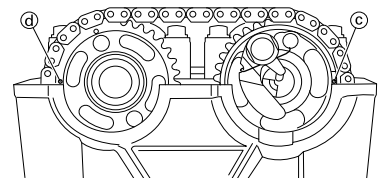

- c. Measure the valve clearance "e" using a feeler gauge "1".

TIP

Record the measured reading if the clearance is incorrect.

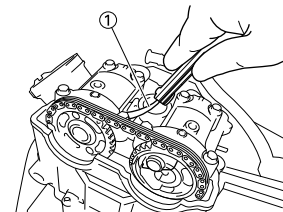
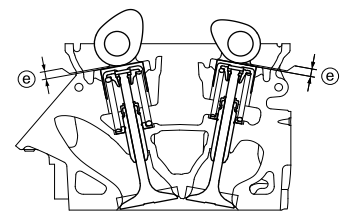

5. Adjust:
- Valve clearance



Adjustment steps:

- Remove the camshaft (intake and exhaust).
Refer to "CAMSHAFTS" section in the CHAPTER 4.
- Remove the valve lifter "1" and the valve pad "2" with a valve lapper "3".

TIP

- Place a rag in the timing chain space to prevent pads from falling into the crankcase.
- Identify each valve lifter and pad position very carefully so that they can be reinstalled in their original place.

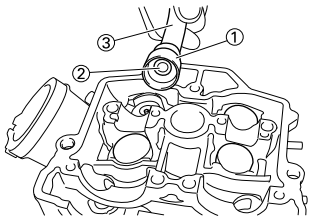

EX	⑥	⑧	
	○	○	
IN	⑥	⑧	①
	○	○	②

- Select the proper pad using the pad selecting table.

Pad range		Pad Availability: 25 increments
No. 120-N	1.20 mm-2.40 mm	Pads are available in 0.05 mm increments
o. 240	40 mm	

TIP

The thickness "a" of each pad is indicated in hundredths of millimeters on the pad upper surface.



- Round off the last digit of the installed pad number to the nearest increment.

Last digit of pad number	Rounded valve
0, 1 or 2	0
4, 5 or 6	5
8 or 9	10

EXAMPLE:

Installed pad number = 148
Rounded off value = 150

TIP

Pads can only be selected in 0.05 mm increments.

- Locate the rounded-off value and the measured valve clearance in the chart "PAD SELECTION TABLE". The field where these two coordinates intersect shows the new pad number to use.

TIP

Use the new pad number only as a guide when verifying the valve clearance adjustment.

- Install the new pads "4" and the valve lifters "5".

TIP

- Apply the engine oil on the valve lifters.
- Apply the molybdenum disulfide oil on the valve stem ends.
- Valve lifter must turn smoothly when rotated with a finger.
- Be careful to reinstall valve lifters and pads in their original place.

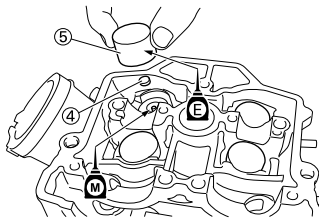

- Install the camshafts (exhaust and intake).
Refer to "CAMSHAFTS" section in the CHAPTER 4.



INTAKE

MEASURED CLEARANCE	INSTALLED PAD NUMBER																								
	120	125	130	135	140	145	150	155	160	165	170	175	180	185	190	195	200	205	210	215	220	225	230	235	240
0.00 ~ 0.04			120	125	130	135	140	145	150	155	160	165	170	175	180	185	190	195	200	205	210	215	220	225	230
0.05 ~ 0.09		120	125	130	135	140	145	150	155	160	165	170	175	180	185	190	195	200	205	210	215	220	225	230	235
0.10 ~ 0.15	STANDARD CLEARANCE																								
0.16 ~ 0.20	125	130	135	140	145	150	155	160	165	170	175	180	185	190	195	200	205	210	215	220	225	230	235	240	
0.21 ~ 0.25	130	135	140	145	150	155	160	165	170	175	180	185	190	195	200	205	210	215	220	225	230	235	240		
0.26 ~ 0.30	135	140	145	150	155	160	165	170	175	180	185	190	195	200	205	210	215	220	225	230	235	240			
0.31 ~ 0.35	140	145	150	155	160	165	170	175	180	185	190	195	200	205	210	215	220	225	230	235	240				
0.36 ~ 0.40	145	150	155	160	165	170	175	180	185	190	195	200	205	210	215	220	225	230	235	240					
0.41 ~ 0.45	150	155	160	165	170	175	180	185	190	195	200	205	210	215	220	225	230	235	240						
0.46 ~ 0.50	155	160	165	170	175	180	185	190	195	200	205	210	215	220	225	230	235	240							
0.51 ~ 0.55	160	165	170	175	180	185	190	195	200	205	210	215	220	225	230	235	240								
0.56 ~ 0.60	165	170	175	180	185	190	195	200	205	210	215	220	225	230	235	240									
0.61 ~ 0.65	170	175	180	185	190	195	200	205	210	215	220	225	230	235	240										
0.66 ~ 0.70	175	180	185	190	195	200	205	210	215	220	225	230	235	240											
0.71 ~ 0.75	180	185	190	195	200	205	210	215	220	225	230	235	240												
0.76 ~ 0.80	185	190	195	200	205	210	215	220	225	230	235	240													
0.81 ~ 0.85	190	195	200	205	210	215	220	225	230	235	240														
0.86 ~ 0.90	195	200	205	210	215	220	225	230	235	240															
0.91 ~ 0.95	200	205	210	215	220	225	230	235	240																
0.96 ~ 1.00	205	210	215	220	225	230	235	240																	
1.01 ~ 1.05	210	215	220	225	230	235	240																		
1.06 ~ 1.10	215	220	225	230	235	240																			
1.11 ~ 1.15	220	225	230	235	240																				
1.16 ~ 1.20	225	230	235	240																					
1.21 ~ 1.25	230	235	240																						
1.26 ~ 1.30	235	240																							
1.31 ~ 1.35	240																								

VALVE CLEARANCE (cold):
 0.10 ~ 0.15 mm
 Example: Installed is 175
 Measured clearance is 0.22 mm
 Replace 175 pad with 185 pad
 Pad number: (example)
 Pad No. 175 = 1.75 mm
 Pad No. 185 = 1.85 mm

EXHAUST

MEASURED CLEARANCE	INSTALLED PAD NUMBER																								
	120	125	130	135	140	145	150	155	160	165	170	175	180	185	190	195	200	205	210	215	220	225	230	235	240
0.00 ~ 0.04					120	125	130	135	140	145	150	155	160	165	170	175	180	185	190	195	200	205	210	215	220
0.05 ~ 0.09				120	125	130	135	140	145	150	155	160	165	170	175	180	185	190	195	200	205	210	215	220	225
0.10 ~ 0.14			120	125	130	135	140	145	150	155	160	165	170	175	180	185	190	195	200	205	210	215	220	225	230
0.15 ~ 0.19		120	125	130	135	140	145	150	155	160	165	170	175	180	185	190	195	200	205	210	215	220	225	230	235
0.20 ~ 0.25	STANDARD CLEARANCE																								
0.26 ~ 0.30	125	130	135	140	145	150	155	160	165	170	175	180	185	190	195	200	205	210	215	220	225	230	235	240	
0.31 ~ 0.35	130	135	140	145	150	155	160	165	170	175	180	185	190	195	200	205	210	215	220	225	230	235	240		
0.36 ~ 0.40	135	140	145	150	155	160	165	170	175	180	185	190	195	200	205	210	215	220	225	230	235	240			
0.41 ~ 0.45	140	145	150	155	160	165	170	175	180	185	190	195	200	205	210	215	220	225	230	235	240				
0.46 ~ 0.50	145	150	155	160	165	170	175	180	185	190	195	200	205	210	215	220	225	230	235	240					
0.51 ~ 0.55	150	155	160	165	170	175	180	185	190	195	200	205	210	215	220	225	230	235	240						
0.56 ~ 0.60	155	160	165	170	175	180	185	190	195	200	205	210	215	220	225	230	235	240							
0.61 ~ 0.65	160	165	170	175	180	185	190	195	200	205	210	215	220	225	230	235	240								
0.66 ~ 0.70	165	170	175	180	185	190	195	200	205	210	215	220	225	230	235	240									
0.71 ~ 0.75	170	175	180	185	190	195	200	205	210	215	220	225	230	235	240										
0.76 ~ 0.80	175	180	185	190	195	200	205	210	215	220	225	230	235	240											
0.81 ~ 0.85	180	185	190	195	200	205	210	215	220	225	230	235	240												
0.86 ~ 0.90	185	190	195	200	205	210	215	220	225	230	235	240													
0.91 ~ 0.95	190	195	200	205	210	215	220	225	230	235	240														
0.96 ~ 1.00	195	200	205	210	215	220	225	230	235	240															
1.01 ~ 1.05	200	205	210	215	220	225	230	235	240																
1.06 ~ 1.10	205	210	215	220	225	230	235	240																	
1.11 ~ 1.15	210	215	220	225	230	235	240																		
1.16 ~ 1.20	215	220	225	230	235	240																			
1.21 ~ 1.25	220	225	230	235	240																				
1.26 ~ 1.30	225	230	235	240																					
1.31 ~ 1.35	230	235	240																						
1.36 ~ 1.40	235	240																							
1.41 ~ 1.45	240																								

VALVE CLEARANCE (cold):
 0.20 ~ 0.25 mm
 Example: Installed is 175
 Measured clearance is 0.32 mm
 Replace 175 pad with 185 pad
 Pad number: (example)
 Pad No. 175 = 1.75 mm
 Pad No. 185 = 1.85 mm

CHASSIS

BLEEDING THE HYDRAULIC BRAKE SYSTEM

⚠ WARNING

Bleed the brake system if:

- The system has been disassembled.
 - A brake hose has been loosened or removed.
 - The brake fluid is very low.
 - The brake operation is faulty.
- A dangerous loss of braking performance may occur if the brake system is not properly bled.**

1. Remove:
 - Brake master cylinder cap
 - Diaphragm
 - Reservoir float (front brake)
 - Protector (rear brake)
2. Bleed:
 - Brake fluid

Air bleeding steps:

- a. Add proper brake fluid to the reservoir.
- b. Install the diaphragm. Be careful not to spill any fluid or allow the reservoir to overflow.
- c. Connect the clear plastic tube "2" tightly to the caliper bleed screw "1".

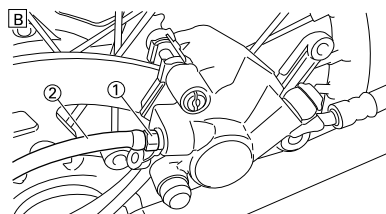
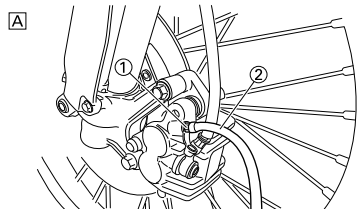

A. Front
B. Rear

- d. Place the other end of the tube into a container.
- e. Slowly apply the brake lever or pedal several times.
- f. Pull the lever in or push down on the pedal. Hold the lever or pedal in position.
- g. Loosen the bleed screw and allow the lever or pedal to travel towards its limit.

- h. Tighten the bleed screw when the lever or pedal limit has been reached; then release the lever or pedal.

	Bleed screw: 6 Nm (0.6 m•kg, 4.3 ft•lb)
---	--

- i. Repeat steps (e) to (h) until the air bubbles have been removed from the system.

TIP

If bleeding is difficult, it may be necessary to let the brake fluid system stabilize for a few hours. Repeat the bleeding procedure when the tiny bubbles in the system have disappeared.

- j. Add brake fluid to the level line on the reservoir.

⚠ WARNING

Check the operation of the brake after bleeding the brake system.



3. Install:
 - Protector (rear brake)
 - Reservoir float (front brake)
 - Diaphragm
 - Brake master cylinder cap

ADJUSTING THE FRONT BRAKE

1. Check:
 - Brake lever position "a"

	Brake lever position "a":	
Standard position	Extent of adjustment	
95 mm (3.74 in)	86–105 mm (3.39–4.13 in)	

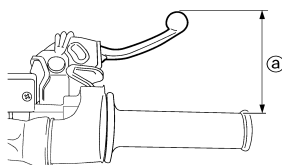

2. Remove:
 - Brake lever cover
3. Adjust:
 - Brake lever position



Brake lever position adjustment steps:

- a. Loosen the locknut "1".

- b. Turn the adjusting bolt "2" until the lever position "a" is within specified position.

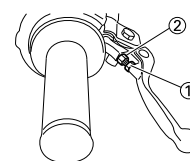

- c. Tighten the locknut.

	Locknut: 5 Nm (0.5 m •kg, 3.6 ft•lb)
---	---

⚠ WARNING

Be sure to tighten the locknut, as it will cause poor brake performance.



4. Install:
 - Brake lever cover

ADJUSTING THE REAR BRAKE

1. Check:
 - Brake pedal height "a"

Out of specification → Adjust.

	Brake pedal height "a": Zero mm (Zero in)
---	--

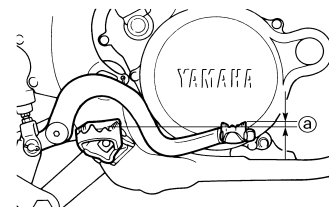

2. Adjust:
 - Brake pedal height



Pedal height adjustment steps:

- a. Loosen the locknut "1".
- b. Turn the adjusting nut "2" until the pedal height "a" is within specified height.

⚠ WARNING

- Adjust the pedal height between the maximum "A" and the minimum "B" as shown. (In this adjustment, the bolt "3" end "b" should protrude out of the threaded portion "4" but not be less than 2 mm (0.08 in) "c" away from the brake pedal "5").
- After the pedal height adjustment, make sure that the rear brake does not drag.

2. Replace:

- Brake pad



Brake pad replacement steps:

- a. Remove the protector "1" and pad pin plug "2".

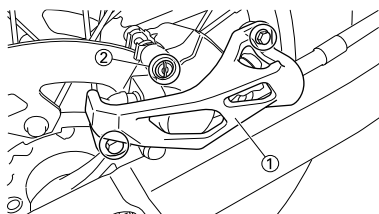

- b. Loosen the pad pin "3".

- c. Remove the rear wheel "4" and brake caliper "5".

Refer to "FRONT WHEEL AND REAR WHEEL" section in the CHAPTER 5.

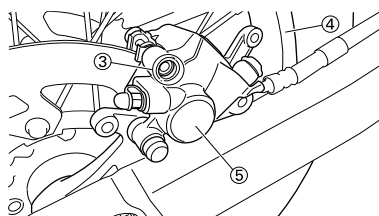

- d. Remove the pad pin "6" and brake pads "7".

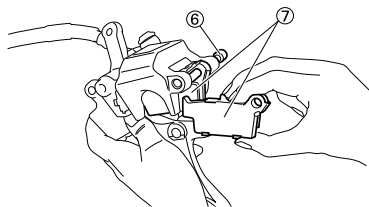

- e. Connect the transparent hose "8" to the bleed screw "9" and place the suitable container under its end.

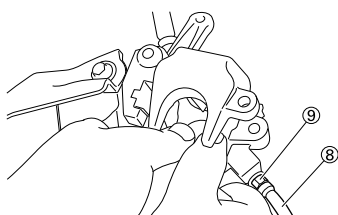

- f. Loosen the bleed screw and push the brake caliper piston in.

⚠ WARNING
Do not reuse the drained brake fluid.

- g. Tighten the bleed screw.

	Bleed screw: 6 Nm (0.6 m•kg, 4.3 ft•lb)
--	---

- h. Install the brake pad "10" and pad pin "11".

TIP

- Install the brake pads with their projections "a" into the brake caliper recesses "b".
- Temporarily tighten the pad pin at this point.

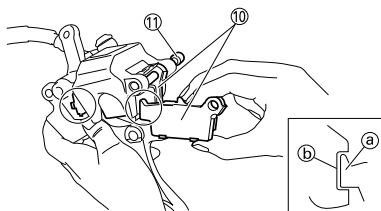

- i. Install the brake caliper "12" and rear wheel "13".

Refer to "FRONT WHEEL AND REAR WHEEL" section in the CHAPTER 5.

- j. Tighten the pad pin "14".

	Pad pin: 18 Nm (1.8 m•kg, 13 ft•lb)
--	---

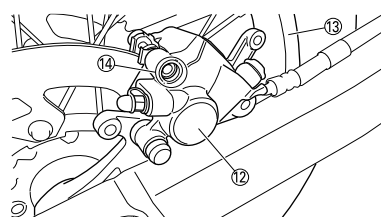

- k. Install the pad pin plug "15" and protector "16".

	Pad pin plug: 2 Nm (0.2 m•kg, 1.4 ft•lb)
	Bolt (protector): 7 Nm (0.7 m•kg, 5.1 ft•lb)

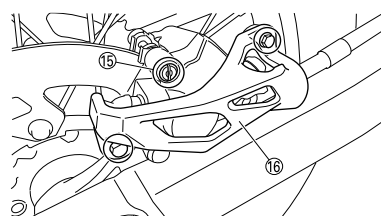

3. Inspect:

- Brake fluid level
Refer to "CHECKING THE BRAKE FLUID LEVEL" section.

4. Check:

- Brake pedal operation
A softy or spongy feeling → Bleed brake system.
Refer to "BLEEDING THE HYDRAULIC BRAKE SYSTEM" section.

CHECKING THE REAR BRAKE PAD INSULATOR

1. Remove:

- Brake pad
Refer to "CHECKING AND REPLACING THE REAR BRAKE PADS" section.

2. Inspect:

- Rear brake pad insulator "1"
Damage → Replace.

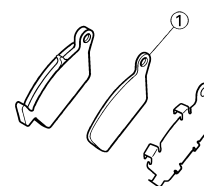

CHECKING THE BRAKE FLUID LEVEL

- Place the brake master cylinder so that its top is in a horizontal position.
- Inspect:
 - Brake fluid level
Fluid at lower level → Fill up.

	Recommended brake fluid: DOT #4
--	---

⚠ WARNING

- Use only designated quality brake fluid to avoid poor brake performance.
- Refill with same type and brand of brake fluid; mixing fluids could result in poor brake performance.
- Be sure that water or other contaminants do not enter master cylinder when refilling.
- Clean up spilled fluid immediately to avoid erosion of painted surfaces or plastic parts.

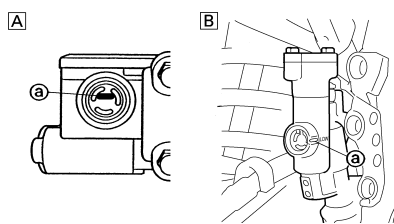

- a. Lower level
- A. Front
- B. Rear

CHECKING THE SPROCKET

1. Inspect:

- Sprocket teeth "a"
Excessive wear → Replace.

TIP

Replace the drive sprocket, rear wheel sprocket and drive chain as a set.

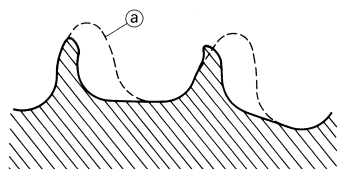

CHECKING THE DRIVE CHAIN

1. Measure:

- Drive chain length (15 links) "a"
Out of specification → Replace.



Drive chain length (15 links):
<Limit>: 242.9 mm (9.563 in)

TIP

- While measuring the drive chain length, push down on the drive chain to increase its tension.
- Measure the length between drive chain roller "1" and "16" as shown.
- Perform this measurement at two or three different places.

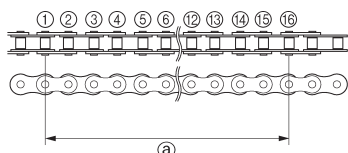

2. Remove:

- Master link clip
- Joint "1"
- Drive chain "2"

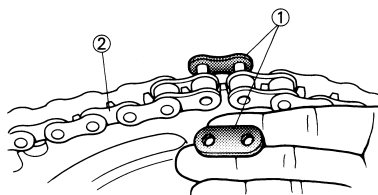

3. Clean:

- Drive chain

Place it in kerosene, and brush off as much dirt as possible. Then remove the drive chain from the kerosene and dry the drive chain.

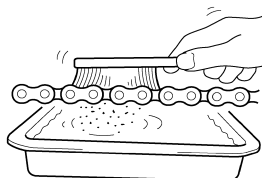

12510301

4. Check:

- Drive chain stiffness "a"
Clean and oil the drive chain and hold as illustrated.
Stiff → Replace the drive chain.

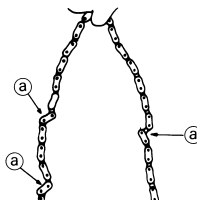

5. Install:

- Drive chain "1"
- Joint "2"
- Master link clip "3" **New**

⚠ WARNING

Be sure to install the master link clip to the direction as shown.

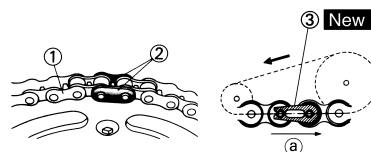

- a. Turning direction

6. Lubricate:

- Drive chain



Drive chain lubricant:
SAE 10W-40 motor oil
or suitable chain lubricants

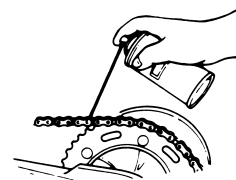

ADJUSTING THE DRIVE CHAIN SLACK

1. Elevate the rear wheel by placing the suitable stand under the engine.

2. Check:

- Drive chain slack "a"
Above the seal guard installation bolt.
Out of specification → Adjust.



Drive chain slack:
50–60 mm (2.0–2.4 in)

TIP

Before checking and/or adjusting, rotate the rear wheel through several revolutions and check the slack several times to find the tightest point. Check and/or adjust the drive chain slack with the rear wheel in this "tight chain" position.

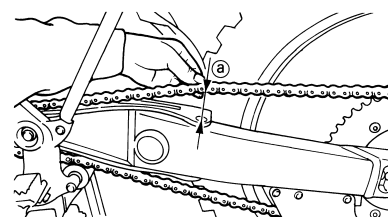

3. Adjust:

- Drive chain slack

Drive chain slack adjustment steps:

- a. Loosen the axle nut "1" and lock-nuts "2".
- b. Adjust the drive chain slack by turning the adjusters "3".

To tighten → Turn the adjuster "3" counterclockwise.
To loosen → Turn the adjuster "3" clockwise and push wheel forward.

- c. Turn each adjuster exactly the same amount to maintain correct axle alignment. (There are marks "a" on each side of the drive chain puller alignment.) **NOTICE: Improper drive chain slack will overload the engine as well as other vital parts of the motorcycle and can lead to chain slippage or breakage. To prevent this from occurring, keep the drive chain slack within the specified limits.**

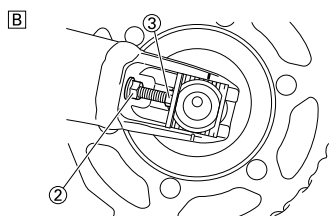
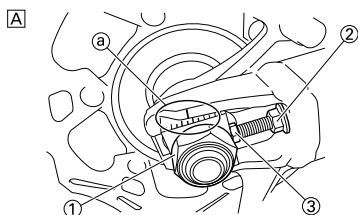

- A. Right
B. Left

TIP
Turn the adjuster so that the drive chain is in line with the sprocket, as viewed from the rear.

- d. Tighten the axle nut while pushing down the drive chain.

	Axle nut: 135 Nm (13.5 m•kg, 98 ft•lb)
---	---

- e. Tighten the locknuts.

	Locknut: 21 Nm (2.1 m•kg, 15 ft•lb)
---	--

CHECKING THE FRONT FORK

1. Inspect:
- Front fork smooth action
Operate the front brake and stroke the front fork.
Unsmooth action/oil leakage → Repair or replace.

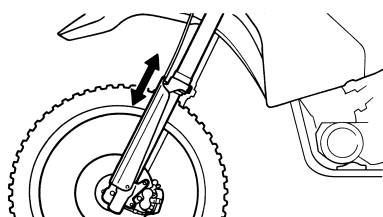

CHECKING THE FRONT FORK PROTECTOR GUIDE

1. Inspect:
- Protector guide "1"
Out of specification → Replace.

TIP
The protector guide reaches the limit of its use when it is worn down to the same height "a" as of the outer tube circumference.

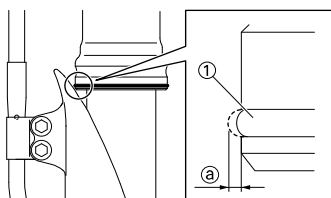

CLEANING THE FRONT FORK OIL SEAL AND DUST SEAL

1. Remove:
- Protector
 - Dust seal "1"

TIP
Use a thin screw driver, and be careful not to damage the inner fork tube and dust seal.

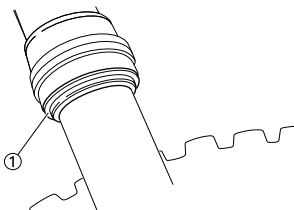

2. Clean:
- Dust seal "a"
 - Oil seal "b"

TIP

- Clean the dust seal and oil seal after every run.
- Apply the lithium soap base grease on the inner tube.

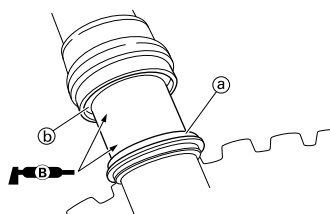

RELIEVING THE FRONT FORK INTERNAL PRESSURE

TIP
If the front fork initial movement feels stiff during a run, relieve the front fork internal pressure.

1. Elevate the front wheel by placing a suitable stand under the engine.
2. Remove the air bleed screw "1" and release the internal pressure from the front fork.
3. Install:
 - Air bleed screw

	Air bleed screw: 1 Nm (0.1 m•kg, 0.7 ft•lb)
---	--

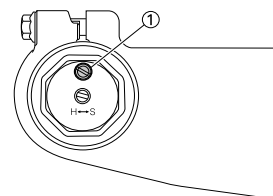

ADJUSTING THE FRONT FORK REBOUND DAMPING FORCE

1. Adjust:
- Rebound damping force
By turning the adjuster "1".

Stiffer "a" → Increase the rebound damping force. (Turn the adjuster "1" in.)

Softer "b" → Decrease the rebound damping force. (Turn the adjuster "1" out.)

	Extent of adjustment:	
	Maximum	Minimum
Fully turned in position	20 clicks out (from maximum position)	

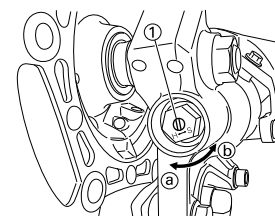

- **STANDARD POSITION:**
This is the position which is back by the specific number of clicks from the fully turned-in position.

	Standard position: 11 clicks out * 10 clicks out
---	---

* Except for USA and CDN

NOTICE

Do not force the adjuster past the minimum or maximum extent of adjustment. The adjuster may be damaged.

WARNING

Always adjust each front fork to the same setting. Uneven adjustment can cause poor handling and loss of stability.

ADJUSTING THE FRONT FORK COMPRESSION DAMPING FORCE

- Adjust:
 - Compression damping force
By turning the adjuster "1".

Stiffer "a" → Increase the compression damping force. (Turn the adjuster "1" in.)
Softer "b" → Decrease the compression damping force. (Turn the adjuster "1" out.)

Extent of adjustment:	
Maximum	Minimum
Fully turned in position	20 clicks out (from maximum position)

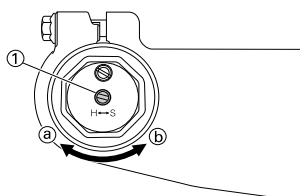

- STANDARD POSITION:**
This is the position which is back by the specific number of clicks from the fully turned-in position.

Standard position:	
9 clicks out	* 11 clicks out

* Except for USA and CDN

NOTICE

Do not force the adjuster past the minimum or maximum extent of adjustment. The adjuster may be damaged.

WARNING

Always adjust each front fork to the same setting. Uneven adjustment can cause poor handling and loss of stability.

CHECKING THE REAR SHOCK ABSORBER

- Inspect:
 - Swingarm smooth action
Abnormal noise/unsmooth action
→ Grease the pivoting points or repair the pivoting points.
Damage/oil leakage → Replace.

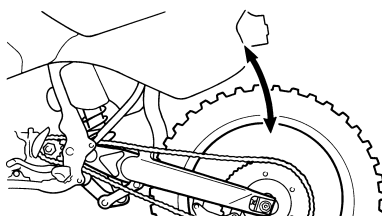

ADJUSTING THE REAR SHOCK ABSORBER SPRING PRELOAD

- Elevate the rear wheel by placing the suitable stand under the engine.
- Measure:
 - Spring fitting length

Standard fitting length:	
I.D. MARK/ Q'TY	Length
White/1	250 mm (9.84 in) *246 mm (9.69 in)

* Except for USA and CDN

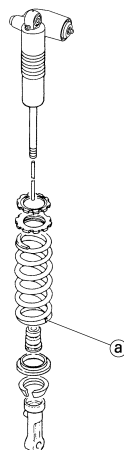

TIP

- The I.D. mark "a" is marked at the end of the spring.
- Spring specification varies according to the difference in the production lot.

- Adjust:
 - Spring preload

Adjustment steps:

- Loosen the locknut "1".
- Loosen the adjuster "2" until there is some clearance between the spring and adjuster.
- Measure the spring free length "a".
- Turn the adjuster "2".

Stiffer → Increase the spring preload. (Turn the adjuster "2" in.)
Softer → Decrease the spring preload. (Turn the adjuster "2" out.)

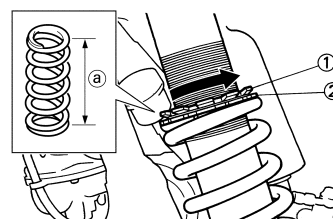

Extent of adjustment:	
Maximum	Minimum
Position in which the spring is turned in 18 mm (0.71 in) from its free length.	Position in which the spring is turned in 1.5 mm (0.06 in) from its free length.

TIP

- Be sure to remove all dirt and mud from around the locknut and adjuster before adjustment.
- The length of the spring (installed) changes 1.5 mm (0.06 in) per turn of the adjuster.

NOTICE

Never attempt to turn the adjuster beyond the maximum or minimum setting.

- Tighten the locknut.

Locknut:	
30 Nm (3.0 m•kg, 22 ft•lb)	

ADJUSTING THE REAR SHOCK ABSORBER REBOUND DAMPING FORCE

1. Adjust:

- Rebound damping force
By turning the adjuster "1".

Stiffer "a" → Increase the rebound damping force. (Turn the adjuster "1" in.)

Softer "b" → Decrease the rebound damping force. (Turn the adjuster "1" out.)

 Extent of adjustment:	
Maximum	Minimum
Fully turned in position	30 clicks out (from maximum position)

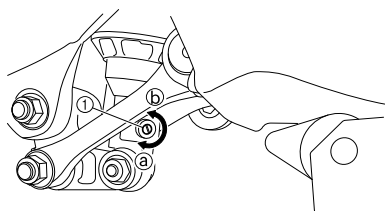

• **STANDARD POSITION:**

This is the position which is back by the specific number of clicks from the fully turned-in position. (Which align the punch mark "a" on the adjuster with the punch mark "b" on the bracket.)

 Standard position:
16–19 clicks out
* 15–18 clicks out

* Except for USA and CDN

NOTICE

Do not force the adjuster past the minimum or maximum extent of adjustment. The adjuster may be damaged.

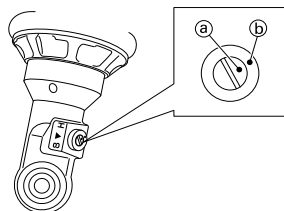

ADJUSTING THE REAR SHOCK ABSORBER LOW COMPRESSION DAMPING FORCE

1. Adjust:

- Low compression damping force
By turning the adjuster "1".

Stiffer "a" → Increase the low compression damping force. (Turn the adjuster "1" in.)

Softer "b" → Decrease the low compression damping force. (Turn the adjuster "1" out.)

 Extent of adjustment:	
Maximum	Minimum
Fully turned in position	20 clicks out (from maximum position)

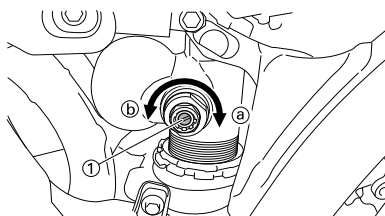

• **STANDARD POSITION:**

This is the position which is back by the specific number of clicks from the fully turned-in position. (Which align the punch mark "a" on the adjuster with the punch mark "b" on the high compression damping adjuster.)

 Standard position:
7–10 clicks out
* 11–14 clicks out

* Except for USA and CDN

NOTICE

Do not force the adjuster past the minimum or maximum extent of adjustment. The adjuster may be damaged.

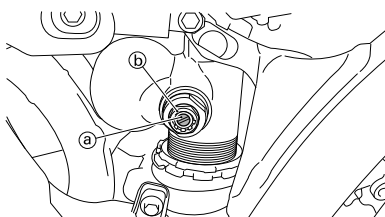

ADJUSTING THE REAR SHOCK ABSORBER HIGH COMPRESSION DAMPING FORCE

1. Adjust:

- High compression damping force
By turning the adjuster "1".

Stiffer "a" → Increase the high compression damping force. (Turn the adjuster "1" in.)

Softer "b" → Decrease the high compression damping force. (Turn the adjuster "1" out.)

 Extent of adjustment:	
Maximum	Minimum
Fully turned in position	2 turns out (from maximum position)

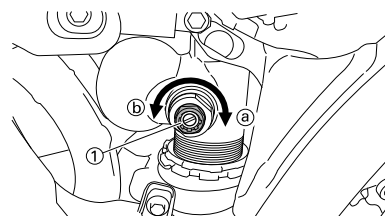

• **STANDARD POSITION:**

This is the position which is back by the specific number of turns from the fully turned-in position. (Which align the punch mark "a" on the adjuster with the punch mark "b" on the adjuster body.)

 Standard position:
1-1/8 ± 1/6 turns out
* 1-1/2 ± 1/6 turns out

* Except for USA and CDN

NOTICE

Do not force the adjuster past the minimum or maximum extent of adjustment. The adjuster may be damaged.

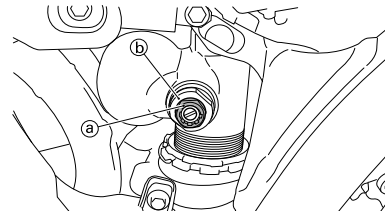

CHECKING THE TIRE PRESSURE

- Measure:
 - Tire pressure
 - Out of specification → Adjust.



Standard tire pressure:
**100 kPa (1.0 kgf/cm²,
 15 psi)**

TIP

- Check the tire while it is cold.
- Loose bead stoppers allow the tire to slip off its position on the rim when the tire pressure is low.
- A tilted tire valve stem indicates that the tire slips off its position on the rim.
- If the tire valve stem is found tilted, the tire is considered to be slipping off its position. Correct the tire position.

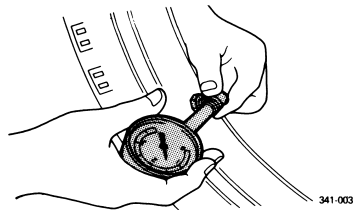

341-003

CHECKING AND TIGHTENING THE SPOKES

The following procedure applies to all of the spokes.

- Check:
 - Spokes
 - Bend/damage → Replace.
 - Loose spoke → Retighten.
 - Tap the spokes with a screwdriver.

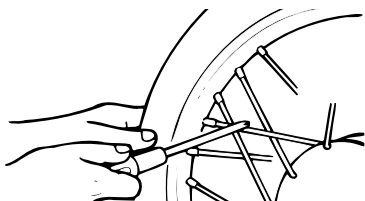

TIP

A tight spoke will emit a clear, ringing tone; a loose spoke will sound flat.

- Tighten:

- Spokes
- (with a spoke nipple wrench "1")

TIP

Be sure to retighten these spokes before and after break-in.

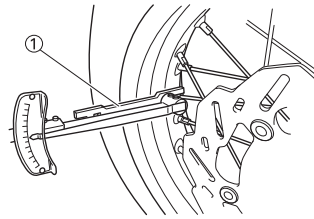

Spoke nipple wrench:
YM-01521/90980-01521



Spokes:
**3 Nm (0.3 m•kg, 2.2
 ft•lb)**

CHECKING THE WHEELS

- Inspect:
 - Wheel runout
 - Elevate the wheel and turn it.
 - Abnormal runout → Replace.

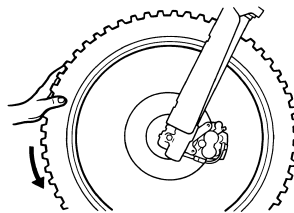

- Inspect:
 - Bearing free play
 - Exist play → Replace.

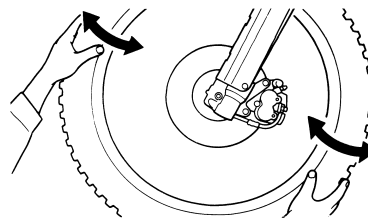

CHECKING AND ADJUSTING THE STEERING HEAD

- Place a stand under the engine to raise the front wheel off the ground. **WARNING! Securely support the vehicle so that there is no danger of it falling over.**
- Check:
 - Steering stem
 - Grasp the bottom of the forks and gently rock the fork assembly back and forth.
 - Free play → Adjust steering head.

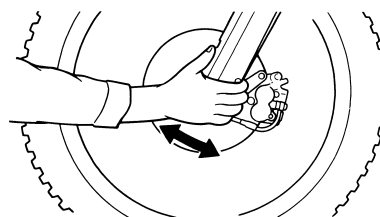

- Check:
 - Steering smooth action
 - Turn the handlebar lock to lock.
 - Unsmooth action → Adjust steering ring nut.

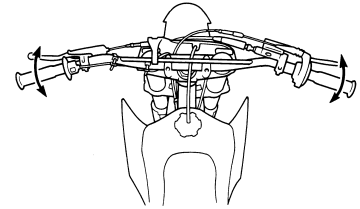

- Adjust:
 - Steering ring nut

Steering ring nut adjustment steps:

- Remove the number plate.
- Remove the handlebar and upper bracket.
- Loosen the steering ring nut "1" using the steering nut wrench "2".



Steering nut wrench:
YU-33975/90890-01403

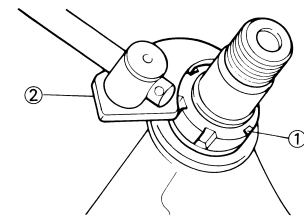

- Tighten the steering ring nut "3" using steering nut wrench "4".

TIP

- Apply the lithium soap base grease on the thread of the steering stem.
- Set the torque wrench to the steering nut wrench so that they form a right angle.



Steering nut wrench:
YU-33975/90890-01403



Steering ring nut (initial tightening):
**38 Nm (3.8 m•kg, 27
 ft•lb)**

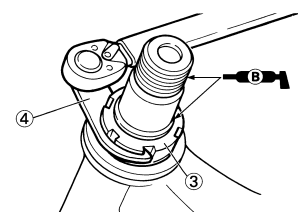

- e. Loosen the steering ring nut one turn.
- f. Retighten the steering ring nut using the steering nut wrench.

WARNING

Avoid over-tightening.



Steering ring nut (final tightening):
7 Nm (0.7 m•kg, 5.1 ft•lb)

- g. Check the steering stem by turning it lock to lock. If there is any binding, remove the steering stem assembly and inspect the steering bearings.
- h. Install the washer "5", upper bracket "6", steering stem nut "7", handlebar "8", handlebar upper holder "9" and number plate "10".

TIP

- Apply the lithium soap base grease on the contact surface of the steering stem nut when installing.
- The handlebar upper holder should be installed with the punched mark "a" forward.
- Install the handlebar so that the marks "b" are in place on both sides.
- Install the handlebar so that the projection "c" of the handlebar upper holder is positioned at the mark on the handlebar as shown.
- Insert the end of the fuel breather hose "11" into the hole in the steering stem.

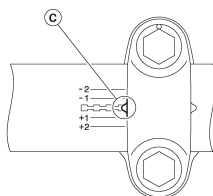
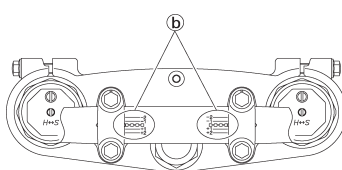
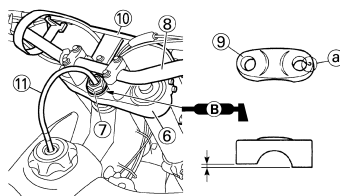
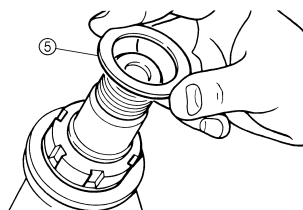

NOTICE

First tighten the bolts on the front side of the handlebar upper holder, and then tighten the bolts on the rear side.



Steering stem nut:
145 Nm (14.5 m•kg, 105 ft•lb)
Handlebar upper holder:
28 Nm (2.8 m•kg, 20 ft•lb)
Pinch bolt (upper bracket):
21 Nm (2.1 m•kg, 15 ft•lb)
Number plate:
7 Nm (0.7 m•kg, 5.1 ft•lb)

LUBRICATION

A

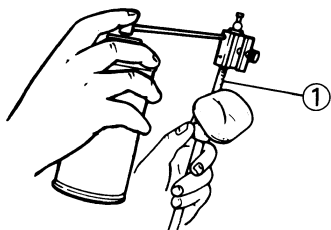

A

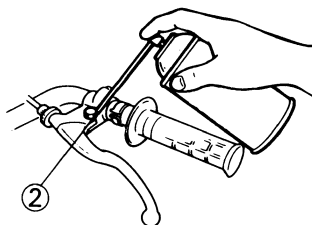

A

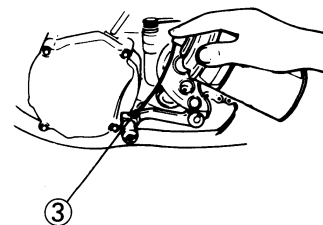

A

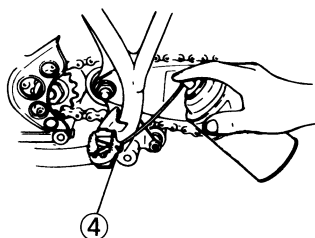

A

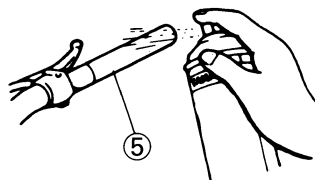

B

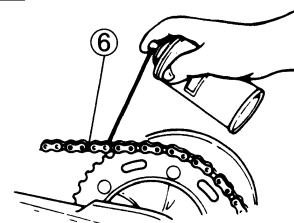

C

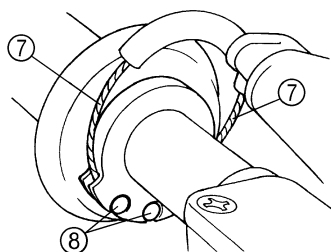

C

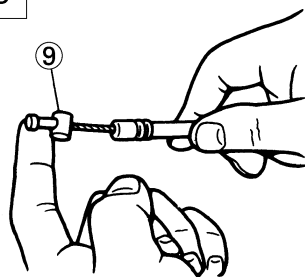

To ensure smooth operation of all components, lubricate your machine during setup, after break-in, and after every race.

1. All control cable
2. Clutch lever pivot
3. Shift pedal pivot
4. Footrest pivot
5. Throttle-to-handlebar contact
6. Drive chain
7. Tube guide cable winding portion
8. Throttle cable end
9. Clutch cable end

- A. Use Yamaha cable lube or equivalent on these areas.
- B. Use SAE 10W-40 motor oil or suitable chain lubricants.
- C. Lubricate the following areas with high quality, lightweight lithium-soap base grease.

⚠ WARNING

Wipe off any excess grease, and avoid getting grease on the brake discs.

ELECTRICAL

CHECKING THE SPARK PLUG

1. Remove:
 - Spark plug
2. Inspect:
 - Electrode "1"
 - Wear/damage → Replace.
 - Insulator color "2"
 - Normal condition is a medium to light tan color.
 - Distinctly different color → Check the engine condition.

TIP

An extended run at low speeds causes the insulator to be colored black even if the air-fuel mixture is normal.

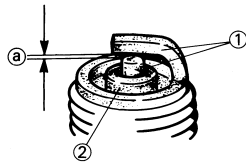

3. Measure:
 - Plug gap "a"
 - Use a wire gauge or thickness gauge.
 - Out of specification → Regap.



Spark plug gap:
0.7–0.8 mm
(0.028–0.031 in)

4. Clean the plug with a spark plug cleaner if necessary.
5. Tighten:
 - Spark plug

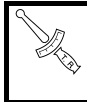

Spark plug:
13 Nm (1.3 m•kg, 9.4 ft•lb)

TIP

- Before installing a spark plug, clean the gasket surface and plug surface.
- Finger-tighten "a" the spark plug before torquing to specification "b".

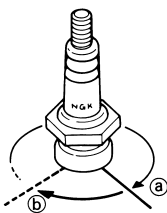

377.004

CHECKING THE IGNITION TIMING

1. Remove:
 - Timing mark accessing screw "1"

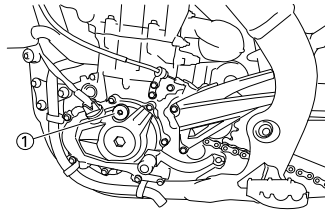

2. Attach:
 - Timing light
 - Digital tachometer
 - To the ignition coil lead (orange lead "1").



Timing light:
YM-33277-A/90890-
03141

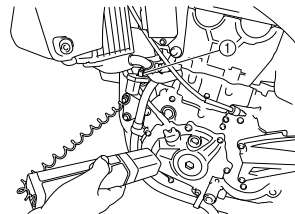

3. Adjust:
 - Engine idling speed
 - Refer to "ADJUSTING THE ENGINE IDLING SPEED" section.
4. Check:
 - Ignition timing
 - Visually check the stationary pointer "a" is within the firing range "b" on the rotor.
 - Incorrect firing range → Check rotor and Crankshaft position sensor.

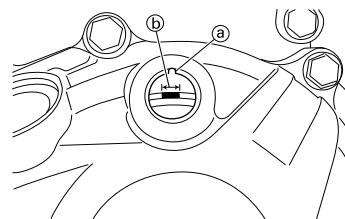

5. Install:
 - Timing mark accessing screw



Timing mark accessing screw:
6 Nm (0.6 m•kg, 4.3 ft•lb)

TROUBLESHOOTING

TIP

The following guide for troubleshooting does not cover all the possible causes of problems. If the following problems occur, perform the specified checks or maintenance jobs. If a problem occurs that is not listed in this manual or if the problem cannot be corrected by the procedures provided in this manual, contact your Yamaha dealer.

Engine starting problems, engine idling speed problems, and medium and high-speed performance problems

- Engine does not start even though the kickstarter is pushed.
- Engine starts, but soon stops.

Engine idling speed problems

- Engine idling speed fluctuates.
- Engine idling speed is high.
- Engine idling speed is low.

Medium and high-speed performance problems

- Engine speed does not increase.
- Engine knocks.
- Engine speed increases suddenly.
- Loss of engine power.

INSPECTION STEPS

If the aforementioned problems have occurred, perform the following inspection steps in the order given.

Check that the fuel tank is filled with fresh gasoline.	No good →	Fill the fuel tank.
OK ↓		
Check that the fuel tank breather hose is not clogged. (Refer to "INCLUDED PARTS" section in the CHAPTER 1.)	No good →	Repair or replace.
OK ↓		
Adjusting the engine idling speed(Refer to "ADJUSTING THE ENGINE IDLLING SPEED" section in the CHAPTER 3.)	No good →	Adjust.
OK ↓		
Check that the fuel hose is connected properly and is not kinked or pinched.	No good →	Repair.
OK ↓		
Check the spark plug for dirt, the spark plug gap, and the spark plug cap. (Refer to "CHECKING THE SPARK PLUG" section in the CHAPTER 3.)	No good →	Clean or adjust.
OK ↓		
Check that the air filter element is installed correctly and is not clogged. (Refer to "CLEANING THE AIR FILTER" section in the CHAPTER 3.)	No good →	Clean or repair.
OK ↓		
Checking the sensors, injector and ignition coil connection.	No good →	Repair or replace.
OK ↓		
Installed condition of ECU (Refer to "CHECKING THE ECU" section in the CHAPTER 7.)	No good →	Repair.
OK ↓		
Check the assembled condition of the throttle body, and check the throttle valve and its surrounding parts for dirt.	No good →	Repair or clean.
OK ↓		
Consult a Yamaha dealer.		

SEAT AND SIDE COVERS

ENGINE

TIP

This section is intended for those who have basic knowledge and skill concerning the servicing of Yamaha motorcycles (e.g., Yamaha dealers, service engineers, etc.) Those who have little knowledge and skill concerning servicing are requested not to undertake inspection, adjustment, disassembly, or reassembly only by reference to this manual. It may lead to servicing trouble and mechanical damage.

SEAT AND SIDE COVERS

REMOVING THE SEAT AND SIDE COVERS

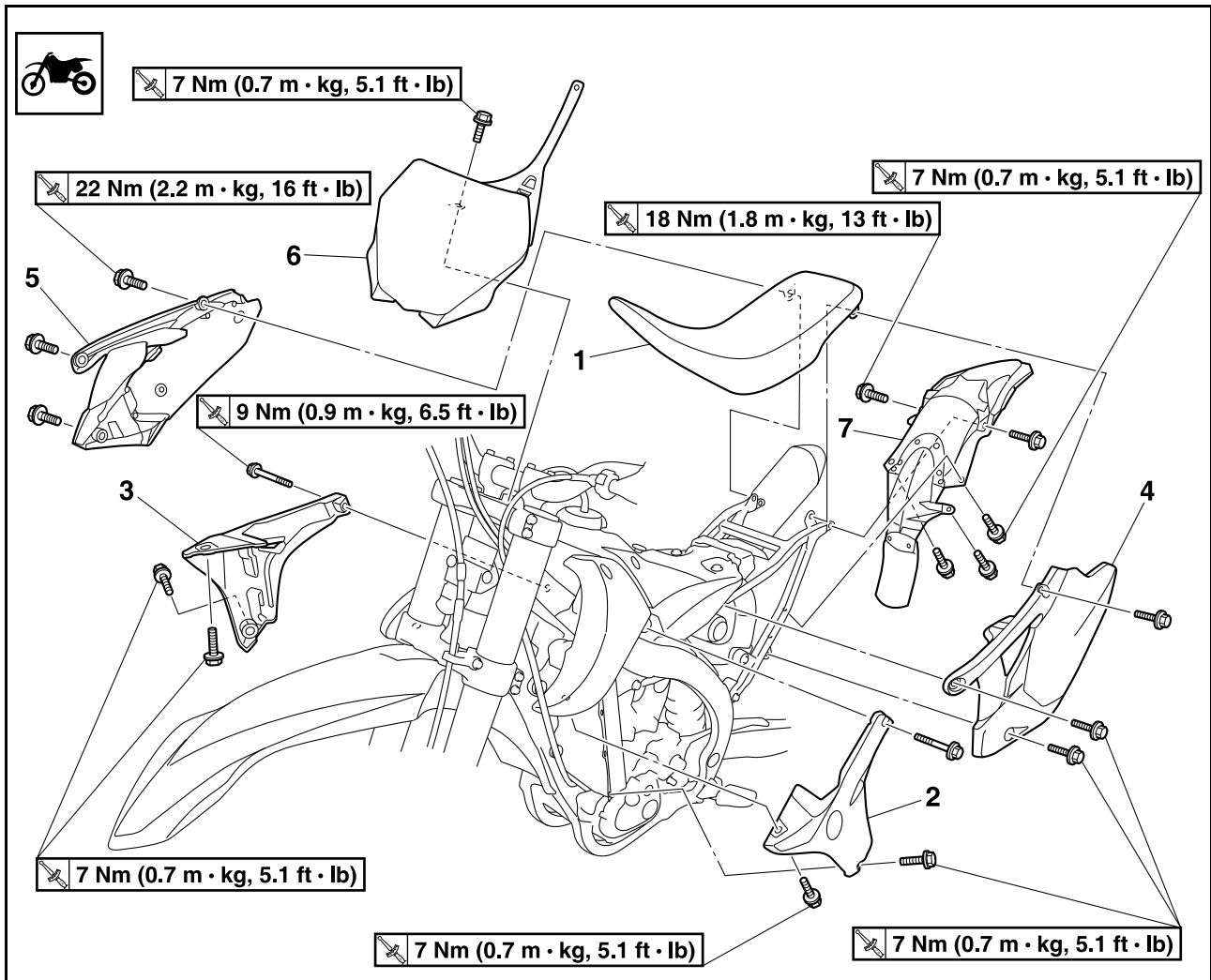

Order	Part name	Q'ty	Remarks
1	Seat	1	
2	Air scoop (left)	1	
3	Air scoop (right)	1	
4	Side cover (left)	1	
5	Side cover (right)	1	
6	Number plate	1	Refer to removal section.
7	Rear fender	1	

REMOVING THE NUMBER PLATE

- Remove:
 - Bolt (number plate)
 - Number plate "1"

TIP

- The projection "a" is inserted into the band of the number plate. Pull the band off the projection before removal.
- Remove the clutch cable "2" from the cable guide "b" on the number plate.
- The projection "c" on the lower bracket is inserted into the number plate. Remove the number plate by pulling it off the projection.

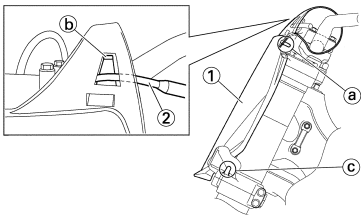

- Insulator 1 "1"
- Insulator 2 "2"
- Insulator 3 "3"
- Insulator 4 "4"
- Insulator 5 "5"
- Insulator 6 "6"

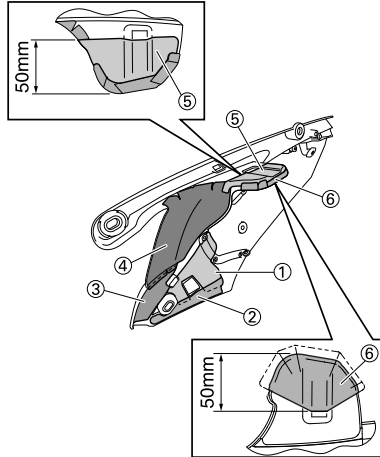

- Insulator 7 "7"
- Insulator 8 "8"
- Insulator 9 "9"

CHECKING AND REPLACING THE PROTECTOR

- Inspect:
 - Protector
Wear/damage → Replace.

TIP

Affix the protector as shown.

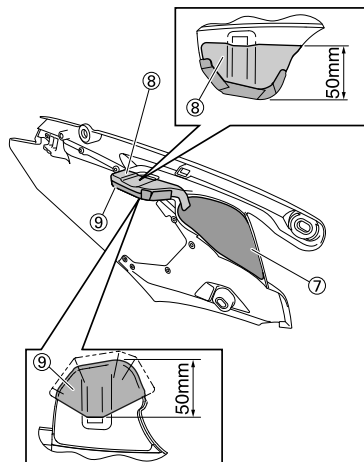
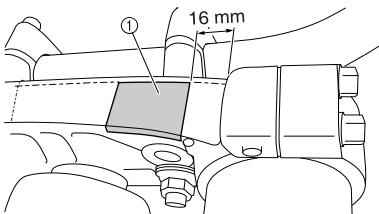

CHECKING AND REPLACING THE INSULATOR

- Inspect:
 - Insulator
Damage/peeled off → Replace.

TIP

- Before affixing the insulators to the side cover, wipe stains etc. off its surface with a degreasing agent or the like.
- Make sure that the insulators do not protrude past the edges of the side covers.
- Affix the insulators in the following order with the portion "a" overlapping one on another.

EXHAUST PIPE AND SILENCER

EXHAUST PIPE AND SILENCER

REMOVING THE EXHAUST PIPE AND SILENCER

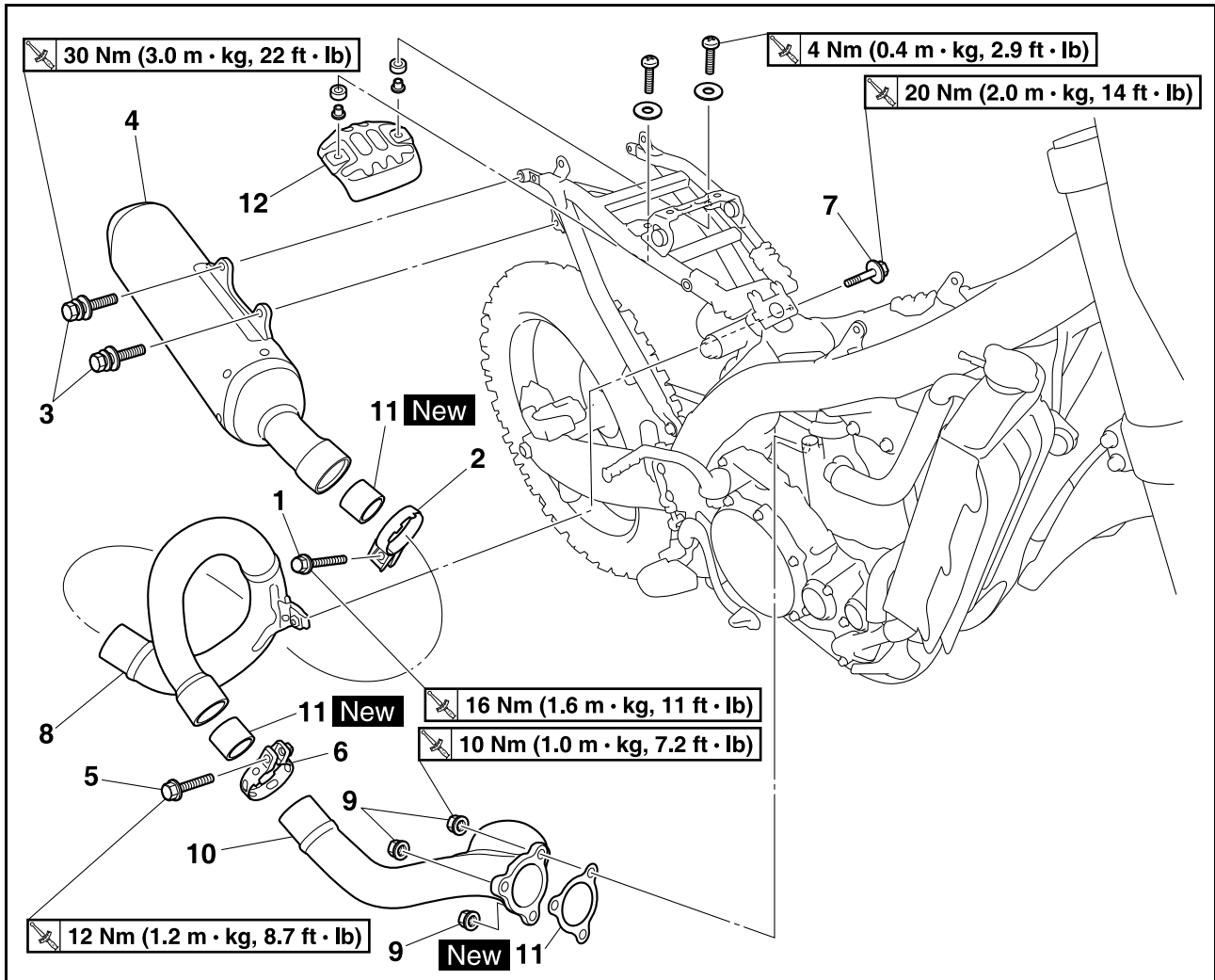

Order	Part name	Q'ty	Remarks
	Seat		Refer to "SEAT AND SIDE COVERS" section.
	Side cover (left and right)		Refer to "SEAT AND SIDE COVERS" section.
	Rear fender		Refer to "SEAT AND SIDE COVERS" section.
1	Bolt (silencer clamp)	1	Only loosening.
2	Silencer clamp	1	
3	Bolt (silencer)	2	
4	Silencer	1	
5	Bolt (exhaust pipe)	1	Only loosening.
6	Silencer clamp	1	
7	Bolt (exhaust pipe 2)	1	
8	Exhaust pipe 2	1	
9	Nut (exhaust pipe)	3	
10	Exhaust pipe 1	1	
11	Gasket	3	
12	Heat protector	1	

EXHAUST PIPE AND SILENCER

CHECKING THE SILENCER AND EXHAUST PIPE

- Inspect:
 - Gasket "1"
 - Damage → Replace.

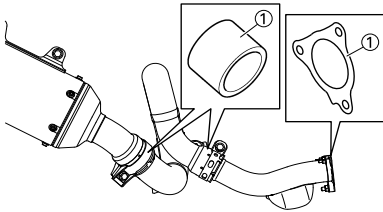

CHANGING THE SILENCER FIBER

- Remove:
 - Rivet (front) "1"
 - Inner pipe "2"

NOTICE

- Take care not to damage the rivet fitting holes ($\varnothing 4.9$ mm) "a" in removal.
- Do not hit the silencer stay "b" as it may do damage to the silencer.

TIP

Remove the inner pipe while holding the silencer in place with a vise etc.

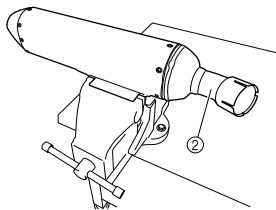
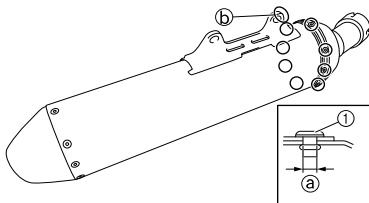

- Replace:
 - Fiber "1"

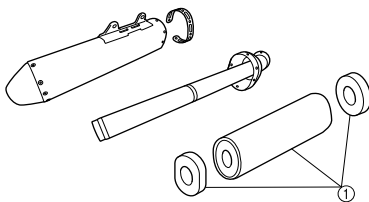

- Install:
 - Inner pipe "1"
 - Rivet (front) "2"
 - Band "3"

TIP

- Apply heat-resistant sealant to the areas "a" shown, making sure that there are no gaps in the beads of sealant.
- Take care not to allow the fiber out of place when installing the inner pipe.
- Install the band "3" with the mating ends "b" positioned as shown.

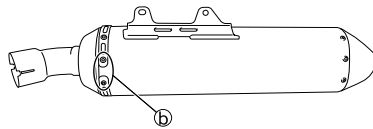
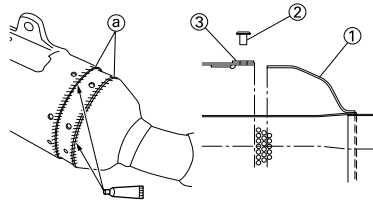

INSTALLING THE SILENCER AND EXHAUST PIPE

- Install:
 - Gasket **New**
 - Exhaust pipe "1"
 - Nut (exhaust pipe) "2"



Nut (exhaust pipe):
10 Nm (1.0 m•kg, 7.2 ft•lb)

TIP

First temporarily tighten both nuts to 7 Nm (0.7 m•kg, 5.1 ft•lb). Then retighten the same nut to 10 Nm (1.0 m•kg, 7.2 ft•lb).

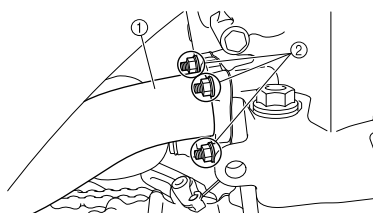

- Install:
 - Silencer clamp (front)
 - Exhaust pipe 2 "1"
 - Bolt (exhaust pipe 2) "2"

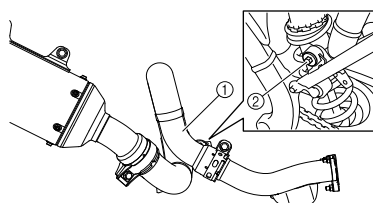

TIP

Install and temporarily tighten the exhaust pipe 2 with its end positioned as shown with respect to the exhaust pipe 1.

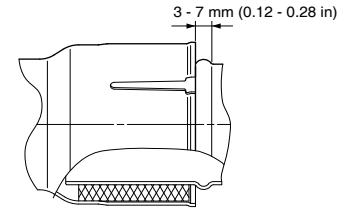

- Install:
 - Silencer clamp (rear)
 - Silencer "1"
 - Bolt (silencer) "2"



Bolt (silencer):
30 Nm (3.0 m•kg, 22 ft•lb)

TIP

Install and temporarily tighten the silencer so that its joint is positioned as shown with respect to the exhaust pipe 2.

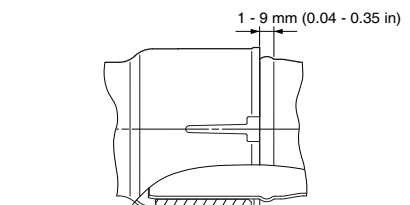
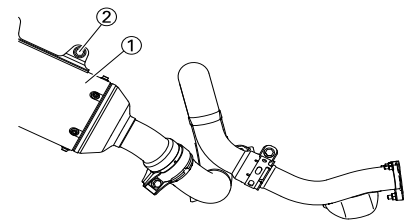

- Install:
 - Bolt (exhaust pipe 2):



Bolt (exhaust pipe 2):
20 Nm (2.0 m•kg, 14 ft•lb)

- Silencer clamp (front):



Silencer clamp (front):
12 Nm (1.2 m•kg, 8.7 ft•lb)

- Silencer clamp (rear):



Silencer clamp (rear):
16 Nm (1.6 m•kg, 11 ft•lb)

TIP

Tighten while checking that their front and rear joints are inserted in position.

RADIATOR

REMOVING THE RADIATOR

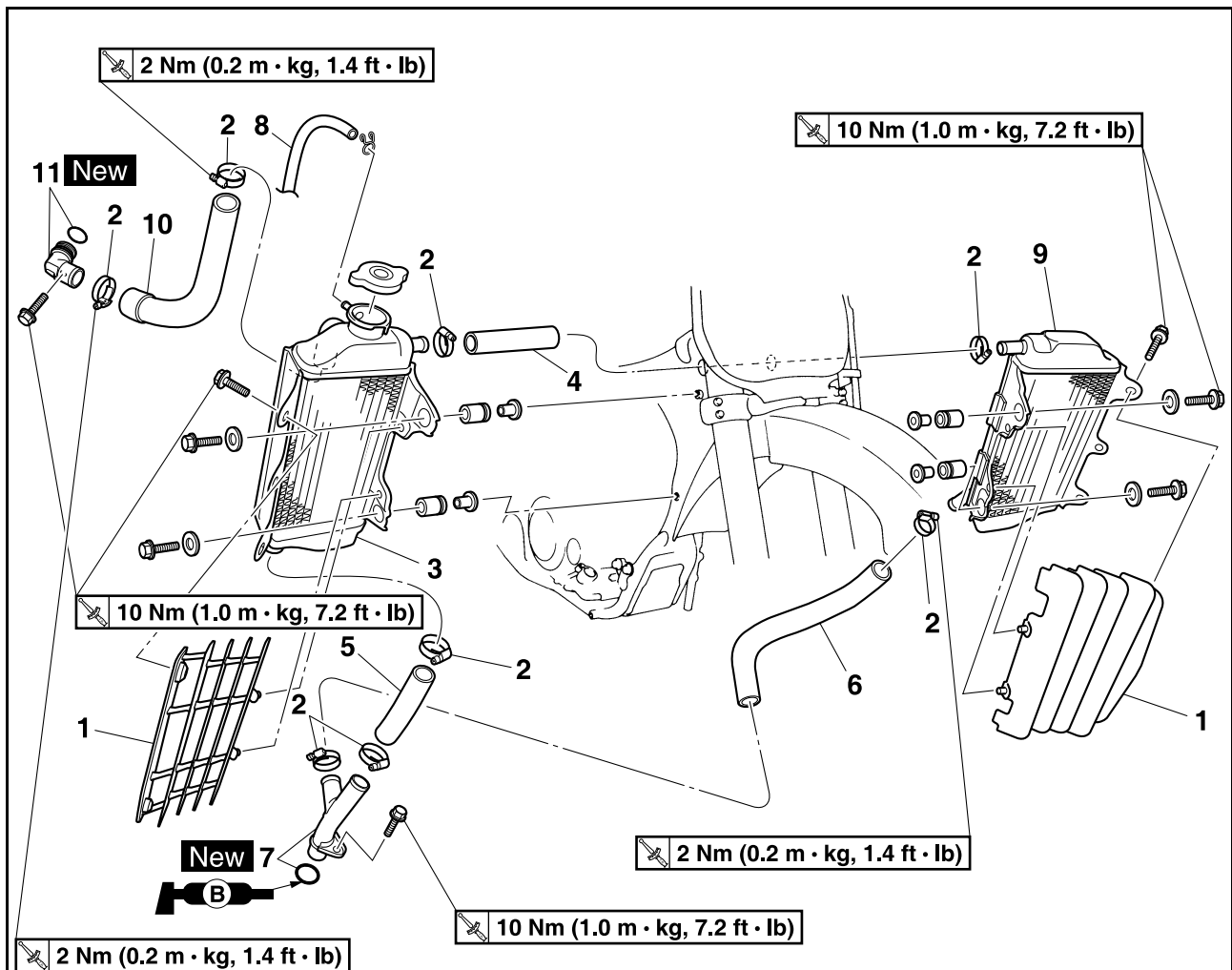

Order	Part name	Q'ty	Remarks
	Drain the coolant.		Refer to "CHANGING THE COOLANT" section in the CHAPTER 3.
	Seat		Refer to "SEAT AND SIDE COVERS" section.
	Fuel tank		Refer to "FUEL TANK" section in the CHAPTER 6.
	Air filter case		Refer to "THROTTLE BODY" section in the CHAPTER 6.
1	Radiator guard	2	
2	Radiator hose clamp	8	Only loosening.
3	Right radiator	1	
4	Radiator hose 2	1	
5	Radiator hose 4	1	
6	Radiator hose 3	1	
7	Pipe 2/O-ring	1/1	
8	Radiator breather hose	1	
9	Left radiator	1	
10	Radiator hose 1	1	

RADIATOR

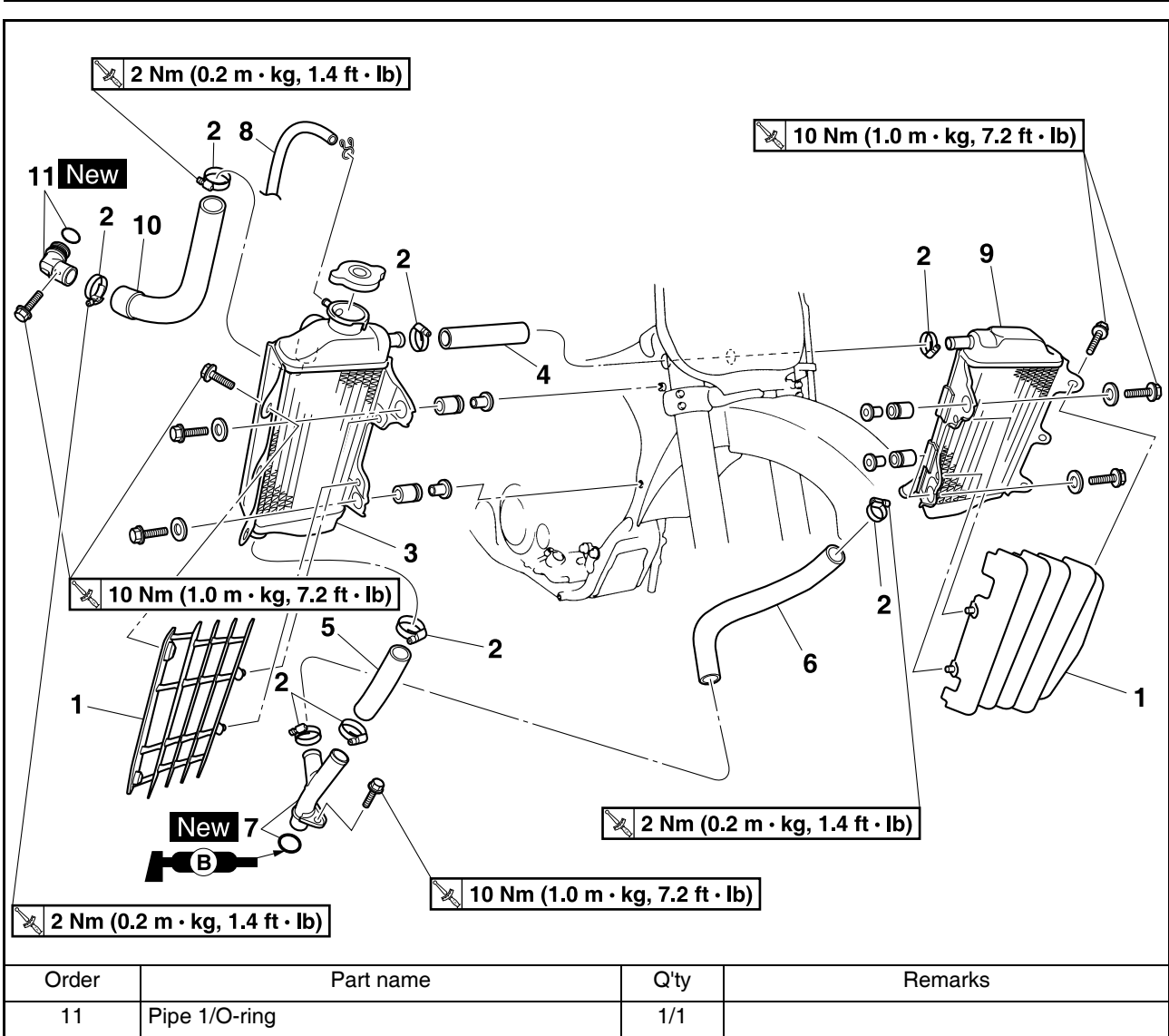

RADIATOR

HANDLING NOTE

⚠ WARNING

Do not remove the radiator cap when the engine and radiator are hot. Scalding hot fluid and steam may be blown out under pressure, which could cause serious injury. When the engine has cooled, open the radiator cap by the following procedure:
Place a thick rag, like a towel, over the radiator cap, slowly rotate the cap counterclockwise to the dent. This procedure allows any residual pressure to escape. When the hissing sound has stopped, press down on the cap while turning counterclockwise and remove it.

CHECKING THE RADIATOR

- Inspect:
 - Radiator core "1"
Obstruction → Blow out with compressed air through rear of the radiator.
 - Bent fin → Repair/replace.

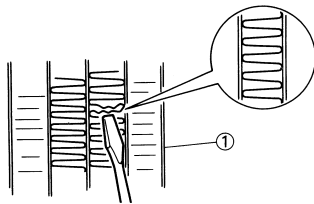

INSTALLING THE RADIATOR

- Install:
 - O-ring "1"
 - Pipe 1 "2"

	Pipe 1: 10 Nm (1.0 m•kg, 7.2 ft•lb)
---	---

- Radiator hose 1 "3"

	Radiator hose 1: 2 Nm (0.2 m•kg, 1.4 ft•lb)
---	---

- O-ring "4"
- Pipe 2 "5"

	Pipe 2: 10 Nm (1.0 m•kg, 7.2 ft•lb)
---	---

- Radiator hose 3 "6"

	Radiator hose 3: 2 Nm (0.2 m•kg, 1.4 ft•lb)
---	---

- Radiator hose 4 "7"

	Radiator hose 4: 2 Nm (0.2 m•kg, 1.4 ft•lb)
---	---

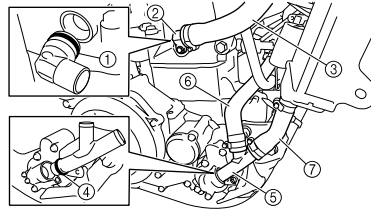

- Install:
 - Grommet "1"

TIP
Face the smaller portion "a" of the grommet inward.

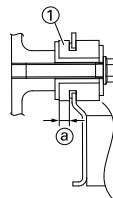

- Install:
 - Radiator hose 2 "1"

	Radiator hose 2: 2 Nm (0.2 m•kg, 1.4 ft•lb)
---	---

- Left radiator "2"

	Left radiator: 10 Nm (1.0 m•kg, 7.2 ft•lb)
---	--

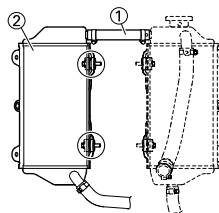

- Install:
 - Radiator breather hose "1"
 - Right radiator "2"

	Right radiator: 10 Nm (1.0 m•kg, 7.2 ft•lb)
---	---

Refer to "CABLE ROUTING DIAGRAM" section in the CHAPTER 2.

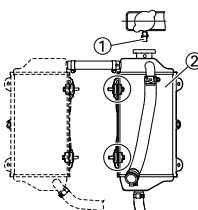

- Install:
 - Radiator guard "1"

TIP
First fit the inner hook portion "a" and then the outer one "b" onto the radiator.

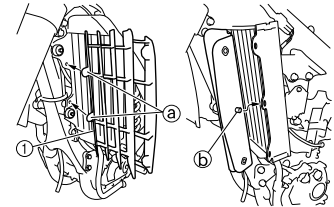

- Install:
 - Bolt (radiator guard) "1"

	Bolt (radiator guard) "1": 10 Nm (1.0 m•kg, 7.2 ft•lb)
---	--

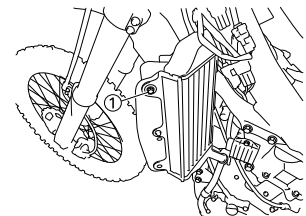

CAMSHAFTS

REMOVING THE CYLINDER HEAD COVER

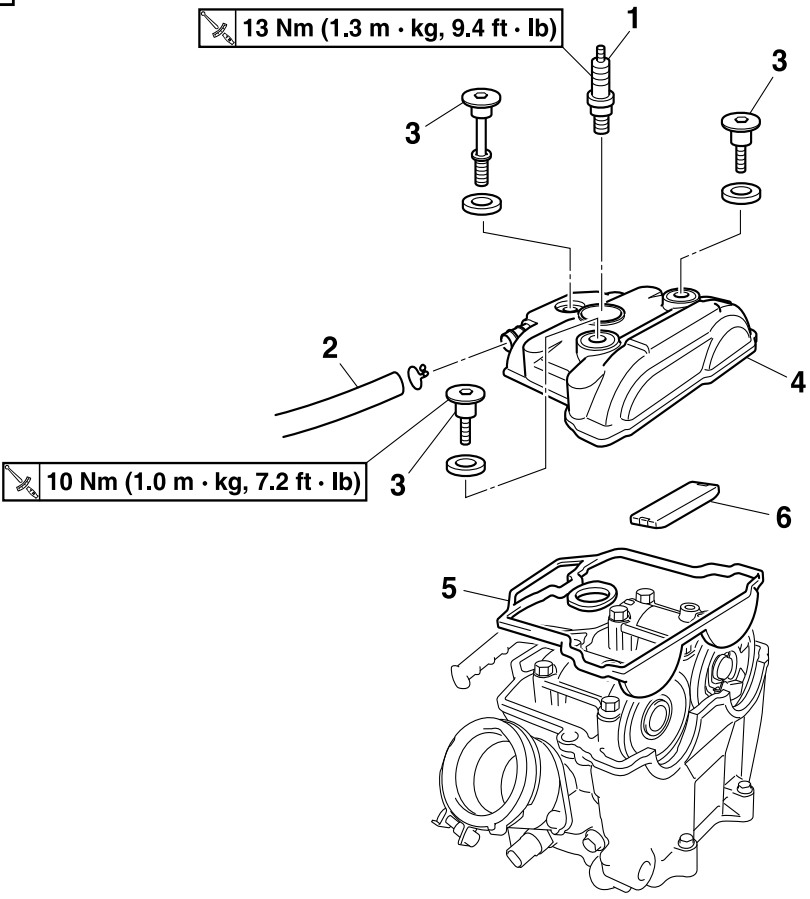

Order	Part name	Q'ty	Remarks
	Seat		Refer to "SEAT AND SIDE COVERS" section.
	Fuel tank		Refer to "FUEL TANK" section in the CHAPTER 6.
	Cover		Refer to "THROTTLE BODY" section in the CHAPTER 6.
1	Spark plug	1	
2	Cylinder head breather hose	1	
3	Bolt (cylinder head cover)	3	
4	Cylinder head cover	1	
5	Cylinder head cover gasket	1	
6	Timing chain guide (top side)	1	

CAMSHAFTS

REMOVING THE CAMSHAFTS

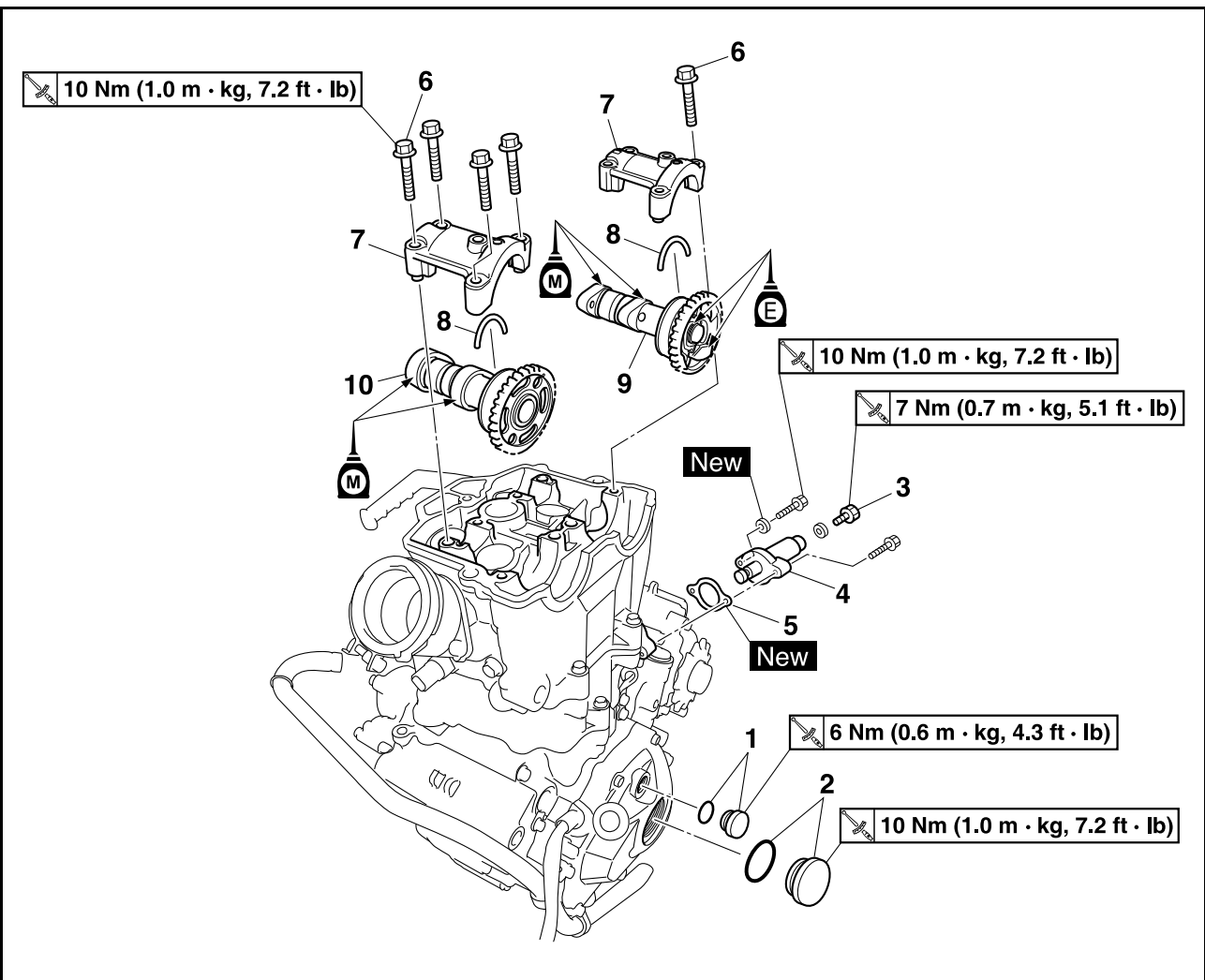

Order	Part name	Q'ty	Remarks
1	Timing mark accessing screw	1	Refer to removal section.
2	Crankshaft end accessing screw	1	Refer to removal section.
3	Timing chain tensioner cap bolt	1	Refer to removal section.
4	Timing chain tensioner	1	Refer to removal section.
5	Gasket	1	Refer to removal section.
6	Bolt (camshaft cap)	8	Refer to removal section.
7	Camshaft cap	2	Refer to removal section.
8	Clip	2	Refer to removal section.
9	Exhaust camshaft	1	Refer to removal section.
10	Intake camshaft	1	Refer to removal section.

REMOVING THE CAMSHAFT

- Remove:
 - Timing mark accessing screw "1"
 - Crankshaft end accessing screw "2"

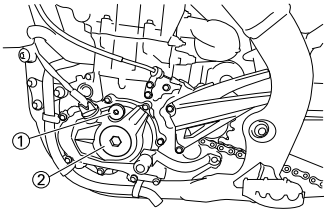

- Align:
 - Alignment mark



Checking steps:

- Turn the crankshaft counterclockwise with a wrench.
- Align the alignment mark "a" on the rotor with the alignment mark "b" on the crankcase cover.

TIP

Make sure that the alignment mark "c" on the exhaust camshaft sprocket and the alignment mark "d" on the intake camshaft sprocket are aligned with the edge of the cylinder head.

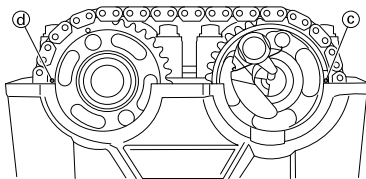
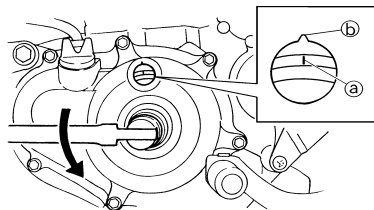

- Remove:
 - Timing chain tensioner cap bolt "1"
 - Timing chain tensioner "2"
 - Gasket

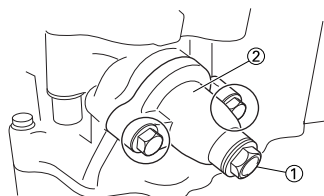

- Remove:
 - Bolt (camshaft cap) "1"
 - Camshaft cap "2"
 - Clip

TIP

Remove the bolts (camshaft cap) in a crisscross pattern, working from the outside in.

NOTICE

The bolts (camshaft cap) must be removed evenly to prevent damage to the cylinder head, camshafts or camshaft caps.

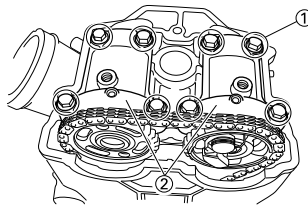

- Remove:
 - Exhaust camshaft "1"
 - Intake camshaft "2"

TIP

Attach a wire "3" to the timing chain to prevent it from falling into the crankcase.

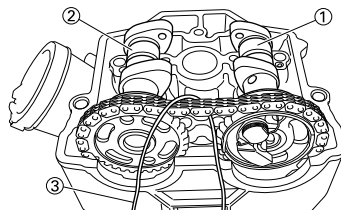

CHECKING THE CAMSHAFT

- Inspect:
 - Cam lobe
 - Pitting/scratches/blue discoloration → Replace.
- Measure:
 - Cam lobe length "a" and "b"
 - Out of specification → Replace.

	Cam lobes length:
	Intake "a":
	37.750–37.850 mm (1.4862–1.4902 in)
	<Limit>:
	37.650 mm (1.4823 in)
	Intake "b":
	28.129–28.229 mm (1.1072–1.1114 in)
	<Limit>:
	28.029 mm (1.1035 in)
	Exhaust "a":
33.540–33.640 mm (1.3205–1.3244 in)	
<Limit>:	
33.440 mm (1.3165 in)	
Exhaust "b":	
24.769–24.869 mm (0.9752–0.9791 in)	
<Limit>:	
24.669 mm (0.9712 in)	

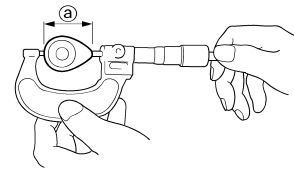

11151001

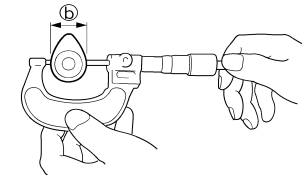

11151002

- Measure:
 - Runout (camshaft)
 - Out of specification → Replace.

	Runout (camshaft):
	Less than 0.03 mm (0.0012 in)

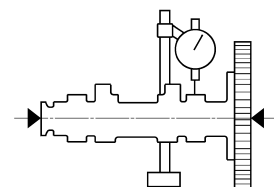

11151002

4. Measure:

- Camshaft-to-cap clearance
Out of specification → Measure camshaft outside diameter.

	Camshaft-to-cap clearance: 0.028–0.062 mm (0.0011–0.0024 in) <Limit>:0.08 mm (0.003 in)
---	--



Measurement steps:

- Install the camshaft onto the cylinder head.
- Position a strip of Plastigauge® "1" onto the camshaft.

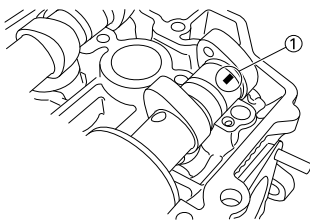

- Install the clip, dowel pins and camshaft caps.

	Bolt (camshaft cap): 10 Nm (1.0 m•kg, 7.2 ft•lb)
---	---

TIP

- Tighten the bolts (camshaft cap) in a crisscross pattern from innermost to outer caps.
- Do not turn the camshaft when measuring clearance with the Plastigauge®.

- Remove the camshaft caps and measure the width of the Plastigauge® "1".

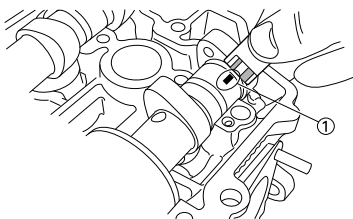

5. Measure:

- Camshaft outside diameter "a"
Out of specification → Replace the camshaft.
Within specification → Replace camshaft case and camshaft caps as a set.

	Camshaft outside diameter: 21.959–21.972 mm (0.8645–0.8650 in)
---	---

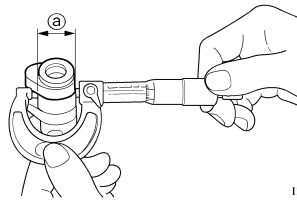

11151003

CHECKING THE CAMSHAFT SPROCKET

1. Inspect:

- Camshaft sprocket "1"
Wear/damage → Replace the camshaft assembly and timing chain as a set.

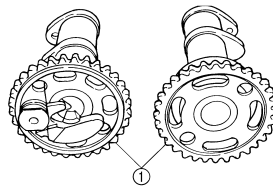

CHECKING THE DECOMPRESSION SYSTEM

1. Check:

- Decompression system



Checking steps:

- Check that the decompression mechanism cam "1" moves smoothly.
- Check that the decompression mechanism cam lever pin "2" projects from the camshaft.

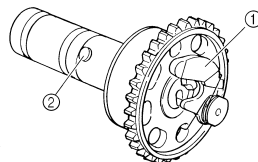

CHECKING THE TIMING CHAIN TENSIONER

1. Check:

- While pressing the tensioner rod lightly with fingers, use a thin screwdriver "1" and wind the tensioner rod up fully clockwise.
- When releasing the screwdriver by pressing lightly with fingers, make sure that the tensioner rod will come out smoothly.
- If not, replace the tensioner assembly.

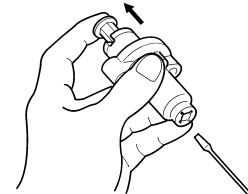
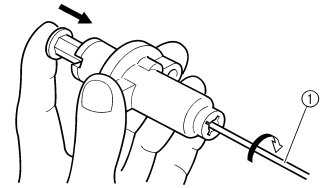

INSTALLING THE CAMSHAFT

1. Install:

- Exhaust camshaft "1"
- Intake camshaft "2"

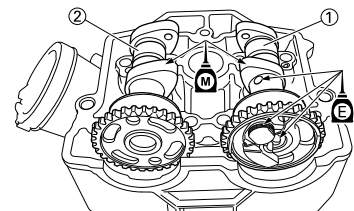

Installation steps:

- Turn the crankshaft counterclockwise with a wrench.

TIP

- Apply the molybdenum disulfide oil on the camshafts.
- Apply the engine oil on the decompression system.
- Fill the cylinder head with engine oil up to the tops "a" of the valve lifters.

- Align the alignment mark "a" on the rotor with the alignment mark "b" on the crankcase cover.

NOTICE

The alignment mark "a" on the rotor is there for camshaft installation. This alignment mark is stamped 23° ATDC.

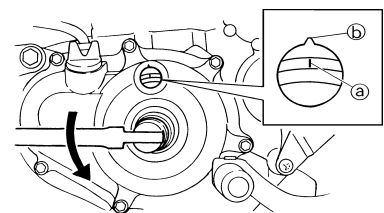

- c. Fit the timing chain "3" onto both camshaft sprockets and install the camshafts on the cylinder head.

TIP

Make sure that the alignment mark "c" on the exhaust camshaft sprocket and the alignment mark "d" on the intake camshaft sprocket are aligned with the edge of the cylinder head.

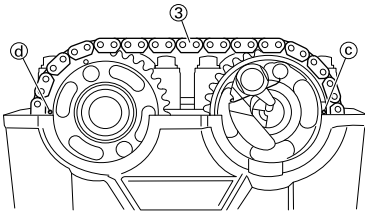

NOTICE

Do not turn the crankshaft during the camshaft installation. Damage or improper valve timing will result.

- d. Install the clips, camshaft caps "4" and bolts (camshaft cap) "5".

	Bolt (camshaft cap): 10 Nm (1.0 m•kg, 7.2 ft•lb)
--	--

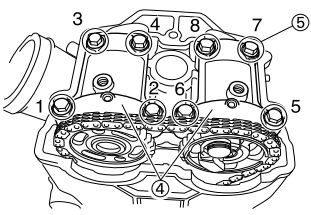

TIP

- Before installing the clips, cover the cylinder head with a clean rag to prevent the clips from into the cylinder head cavity.
- Tighten the bolts to the specified torque in two or three steps in the proper tightening sequence as shown.

NOTICE

The bolts (camshaft cap) must be tightened evenly, or damage to the cylinder head, camshaft caps, and camshaft will result.



- 2. Install:
 - Timing chain tensioner



Installation steps:

- a. While pressing the tensioner rod lightly with fingers, use a thin screwdriver and wind the tensioner rod up fully clockwise.

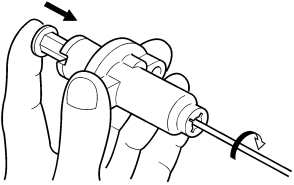

- b. With the rod fully wound and the chain tensioner UP mark "a" facing upward, install the gasket "1", the timing chain tensioner "2", and the gasket "3", and tighten the bolt "4" to the specified torque.

	Bolt (timing chain tensioner): 10 Nm (1.0 m•kg, 7.2 ft•lb)
---	--

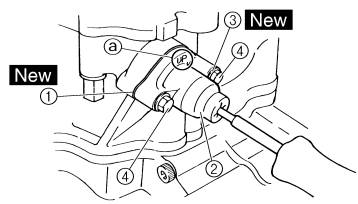

- c. Release the screwdriver, check the tensioner rod to come out and tighten the gasket "5" and the cap bolt "6" to the specified torque.

	Tensioner cap bolt: 7 Nm (0.7 m•kg, 5.1 ft•lb)
---	--

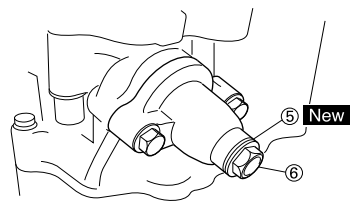

- 3. Turn:
 - Crankshaft
Counterclockwise several turns.
- 4. Check:
 - Alignment mark
Align with the crankcase align mark.
 - Camshaft match marks
Align with the cylinder head surface.
Out of alignment → Adjust.

CYLINDER HEAD

CYLINDER HEAD

REMOVING THE CYLINDER HEAD

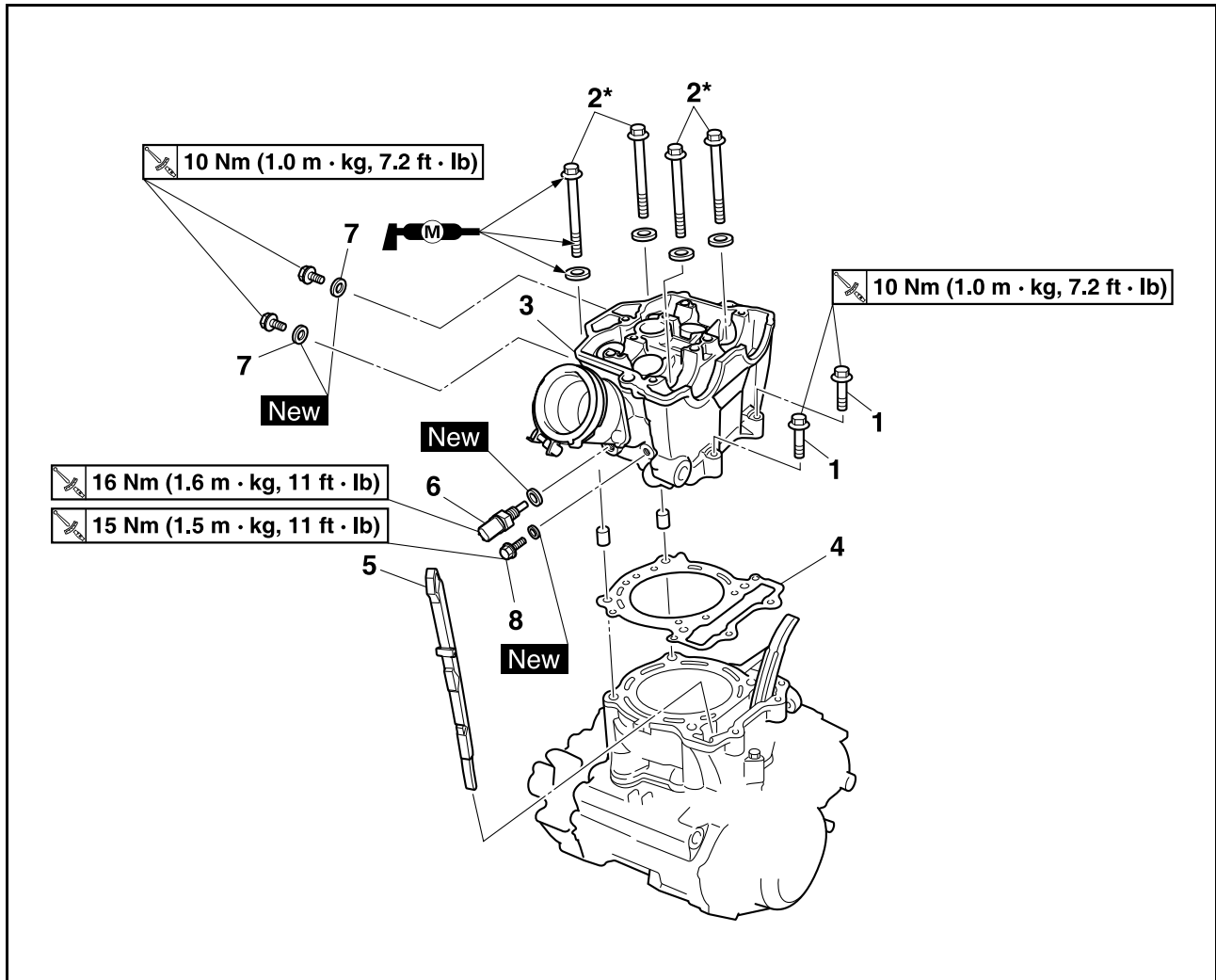

Order	Part name	Q'ty	Remarks
	Seat		Refer to "SEAT AND SIDE COVERS" section.
	Fuel tank		Refer to "FUEL TANK" section in the CHAPTER 6.
	Exhaust pipe and silencer		Refer to "EXHAUST PIPE AND SILENCER" section.
	Radiator		Refer to "RADIATOR" section
	Throttle body		Refer to "THROTTLE BODY" section in the CHAPTER 6.
	Camshaft		Refer to "CAMSHAFTS" section.

CYLINDER HEAD

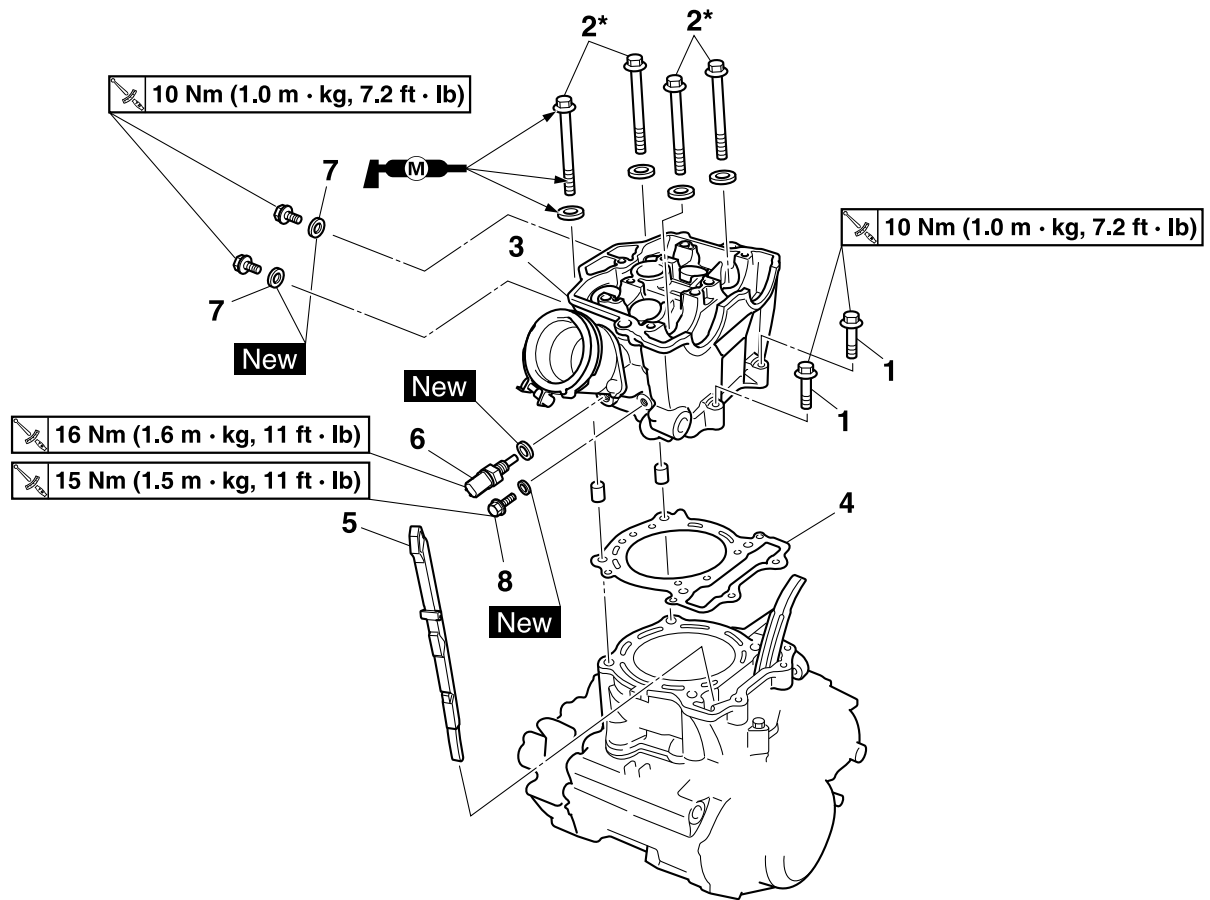

Order	Part name	Q'ty	Remarks
1	Bolt (cylinder head)	2	
2	Bolt (cylinder head)	4	Refer to TIP.
3	Cylinder head	1	
4	Cylinder head gasket	1	
5	Timing chain guide (intake side)	1	
6	Coolant temperature sensor	1	
7	Oil check bolt	2	
8	Oil passage plug	1	

TIP

Tighten the cylinder head bolts to 30 Nm (3.0 m•kg, 22 ft•lb) in the proper tightening sequence, remove and retighten the cylinder head bolts to 20 Nm (2.0 m•kg, 14 ft•lb) in the proper tightening sequence, and then tighten the cylinder head bolts further to reach the specified angle 150° in the proper tightening sequence.

CYLINDER HEAD

CHECKING THE CYLINDER HEAD

- Eliminate:
 - Carbon deposits (from the combustion chambers)
Use a rounded scraper.

TIP
Do not use a sharp instrument to avoid damaging or scratching:

- Spark plug threads
- Valve seats

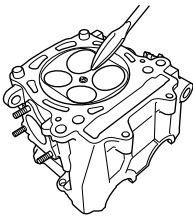

- Inspect:
 - Cylinder head
Scratches/damage → Replace.

TIP
Replace the titanium valves with the cylinder head.

Refer to "CHECKING THE VALVE".

- Measure:
 - Cylinder head warpage
Out of specification → Resurface.

	Cylinder head warpage: Less than 0.05 mm (0.002 in)
--	--

Warpage measurement and resurfacing steps:

- Place a straightedge and a feeler gauge across the cylinder head.
- Use a feeler gauge to measure the warpage.
- If the warpage is out of specification, resurface the cylinder head.
- Place a 400–600 grit wet sandpaper on the surface plate, and resurface the head using a figure-eight sanding pattern.

TIP
To ensure an even surface rotate the cylinder head several times.

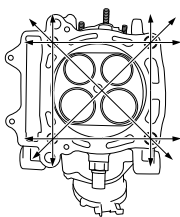

INSTALLING THE CYLINDER HEAD

- Install:
 - Timing chain guide (intake side) "1"
 - Dowel pin "2"
 - Cylinder head gasket "3" **New**
 - Cylinder head "4"

TIP
While pulling up the timing chain, install the timing chain guide (intake side) and cylinder head.

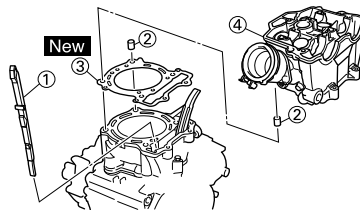

- Install:
 - Washer "1"
 - Bolts "2"

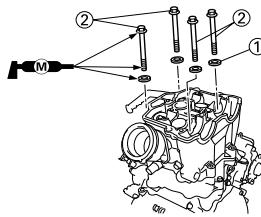

Installation steps:

NOTICE
Tighten the cylinder head using the rotation angle procedure to obtain uniform tightening torque.

- Wash the threads and contact surfaces of the bolts, the contact surfaces of the plain washers, the contact surface of the cylinder head, and the threads of the crankcase.
- Apply the molybdenum disulfide grease on the threads and contact surfaces of the bolts and on both contact surfaces of the plain washers.
- Install the plain washers and bolts.

- Tighten the bolts to the specified torque in two or three steps in the proper tightening sequence as shown.

	Bolts (cylinder head): 1st: 30 Nm (3.0 m•kg, 22 ft•lb)
--	---

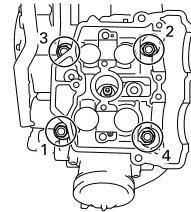

- Remove the bolts.
- Again apply the molybdenum disulfide grease on the threads and contact surfaces of the bolts and on both contact surfaces of the plain washers.
- Retighten the bolts.

TIP
Tighten the bolts to the specified torque in two or three steps in the proper tightening sequence as shown.

	Bolts (cylinder head): 2nd: 20 Nm (2.0 m•kg, 14 ft•lb)
--	---

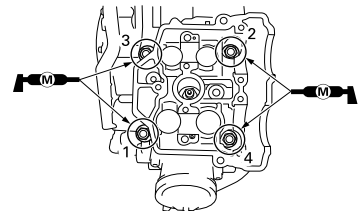

- Put a mark on the corner "1" of the bolt (cylinder head) and the cylinder head "2" as shown.

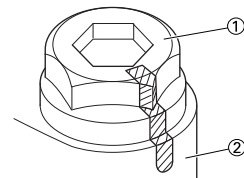

TIP

Tighten the bolts two times at specified angles of 90° and 60° to reach the specified angle of 150° in the proper tightening sequence as shown.

	Bolts (cylinder head): Final: Specified angle 150°
---	---

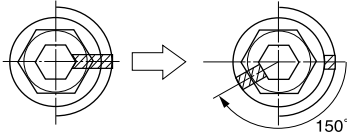

3. Install:

- Bolt (cylinder head) "1"

	Bolt (cylinder head): 10 Nm (1.0 m•kg, 7.2 ft•lb)
---	--

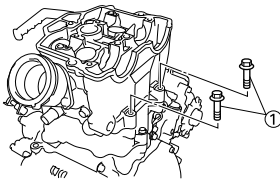

VALVES AND VALVE SPRINGS

VALVES AND VALVE SPRINGS

REMOVING THE VALVES AND VALVE SPRINGS

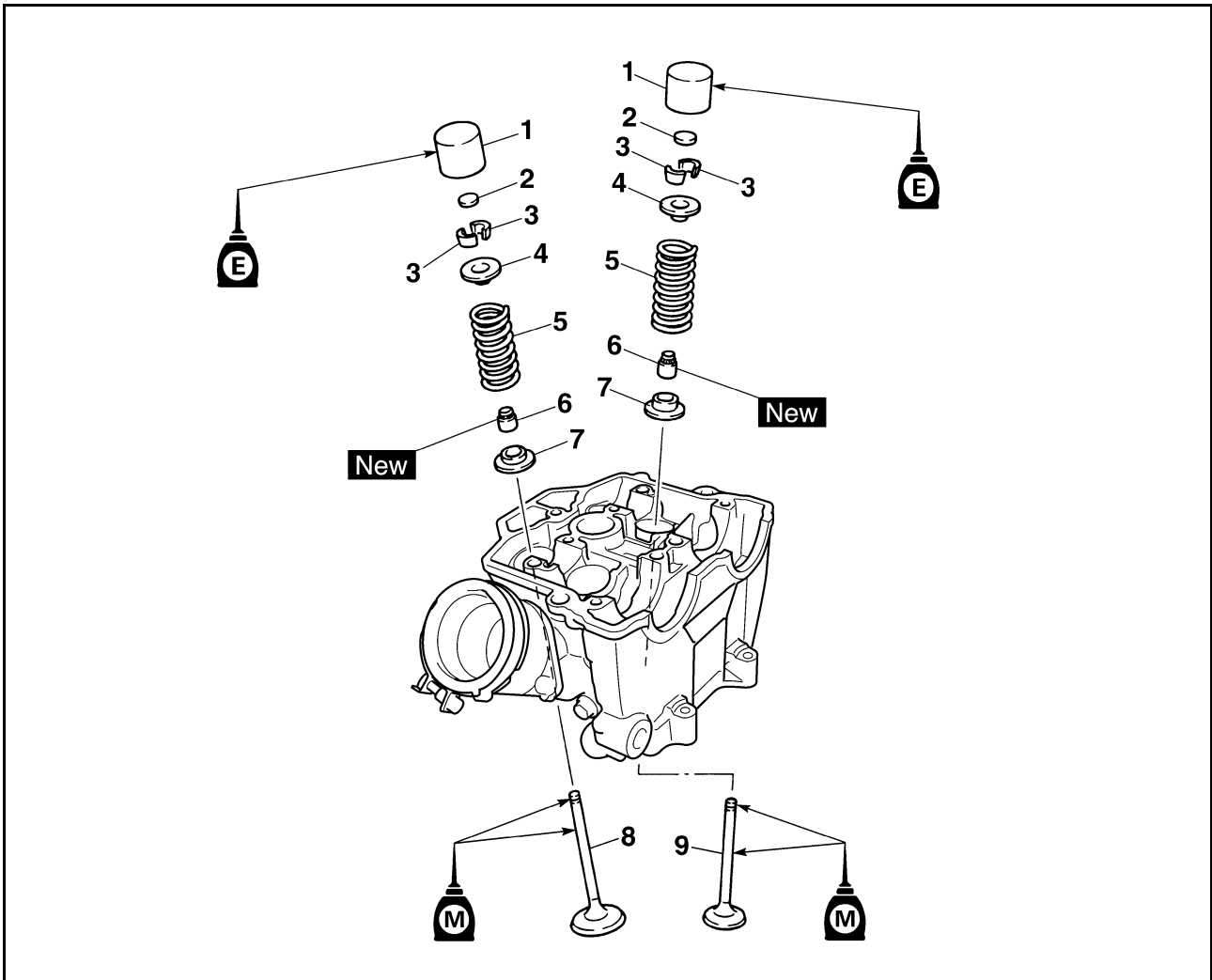

Order	Part name	Q'ty	Remarks
	Cylinder head		Refer to "CYLINDER HEAD" section.
1	Valve lifter	4	Refer to removal section.
2	Adjusting pad	4	Refer to removal section.
3	Valve cotter	8	Refer to removal section.
4	Valve spring retainer	4	
5	Valve spring	4	
6	Valve stem seal	4	
7	Valve spring seat	4	
8	Exhaust valve	2	
9	Intake valve	2	

VALVES AND VALVE SPRINGS

REMOVING THE VALVE LIFTER AND VALVE COTTER

- Remove:
 - Valve lifter "1"
 - Pad "2"

TIP
Identify each lifter "1" and pad "2" position very carefully so that they can be reinstalled in their original place.

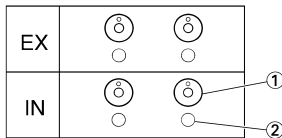

- Check:
 - Valve sealing
Leakage at the valve seat → Inspect the valve face, valve seat and valve seat width.

Checking steps:

- Pour a clean solvent "1" into the intake and exhaust ports.
- Check that the valve seals properly.
There should be no leakage at the valve seat "2".

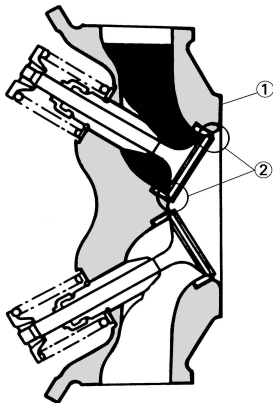

- Remove:
 - Valve cotter

TIP
Remove the valve cotters by compressing the valve spring with the valve spring compressor "1" and the valve spring compressor attachment "2".

	Valve spring compressor: YM-4019/90890-04019
--	--

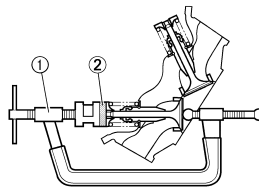

11171201

CHECKING THE VALVE

- Measure:
 - Stem-to-guide clearance

Stem-to-guide clearance = valve guide inside diameter "a" - valve stem diameter "b"

Out of specification → Replace the valve guide.

	Clearance (stem to guide): Intake: 0.010–0.037 mm (0.0004–0.0015 in) <Limit>:0.08 mm (0.003 in) Exhaust: 0.020–0.047 mm (0.0008–0.0019 in) <Limit>:0.10 mm (0.004 in)
--	--

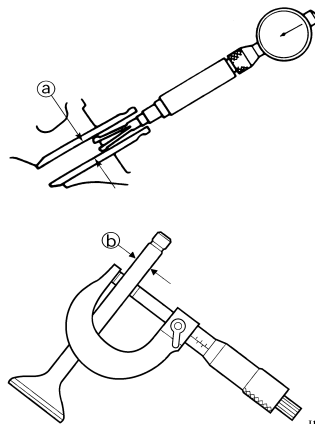

11172102

- Replace:
 - Valve guide

Replacement steps:

TIP
To ease guide removal, installation and to maintain correct fit heat the cylinder head in an oven to 100 °C (212°F).

- Remove the valve guide using a valve guide remover "1".

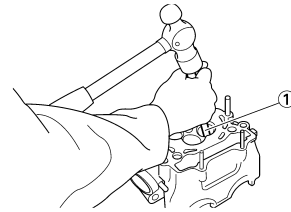

- Install the new valve guide using a valve guide remover "1" and valve guide installer "2".

	Valve guide installation height "a": Intake: 15.1–15.5 mm (0.59–0.61 in) Exhaust: 12.2–12.6 mm (0.48–0.50 in)
--	--

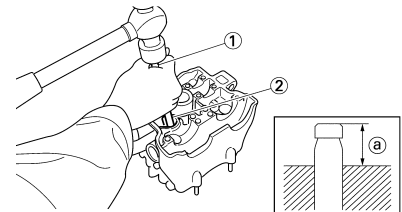

- After installing the valve guide, bore the valve guide using a valve guide reamer "3" to obtain proper stem-to-guide clearance.

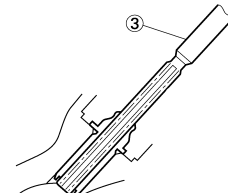

11170691

	Valve guide remover & installer set (ø5.5): 90890-04016 Valve guide remover (5.5 mm): YM-01122 Valve guide installer (5.5 mm): YM-04015 Valve guide reamer (5.5 mm): YM-01196
--	---

TIP
After replacing the valve guide reface the valve seat.

VALVES AND VALVE SPRINGS

3. Inspect:
 - Valve face
Pitting/wear → Grind the face.
 - Valve stem end
Mushroom shape or diameter larger than the body of the stem → Replace.
4. Measure:
 - Margin thickness "a"
Out of specification → Replace.

	Margin thickness:
	Intake: 1.3 mm (0.051 in)
	Exhaust: 1.0 mm (0.039 in)

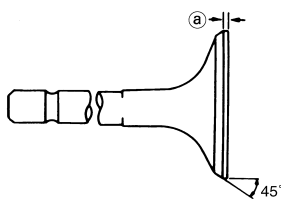

5. Measure:
 - Runout (valve stem)
Out of specification → Replace.

	Runout limit:
	0.01 mm (0.0004 in)

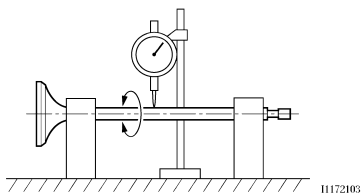

6. Eliminate:
 - Carbon deposits
(from the valve face and valve seat)
7. Inspect:
 - Valve seat
Pitting/wear → Reface the valve seat.
8. Measure:
 - Valve seat width "a"
Out of specification → Reface the valve seat.

	Valve seat width:
	Intake:
	0.9–1.1 mm (0.0354–0.0433 in)
	<Limit>: 1.6 mm (0.0630 in)
	Exhaust:
	0.9–1.1 mm (0.0354–0.0433 in)
<Limit>: 1.6 mm (0.0630 in)	

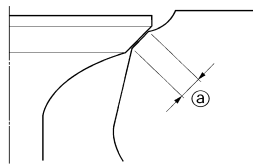

Measurement steps:

- a. Apply Mechanic's blueing dye (Dykem) "b" to the valve face.

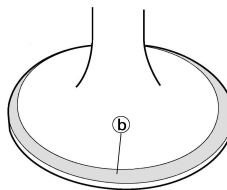

- b. Install the valve into the cylinder head.
- c. Press the valve through the valve guide and onto the valve seat to make a clear pattern.
- d. Measure the valve seat width. Where the valve seat and valve face made contact, blueing will have been removed.
- e. If the valve seat is too wide, too narrow, or the seat is not centered, the valve seat must be refaced.



9. Lap:
 - Valve face
 - Valve seat

NOTICE

This model uses titanium intake and exhaust valves. Titanium valves that have been used to lap the valve seats must not be used. Always replace lapped valves with new valves.

TIP

- When replacing the cylinder head, replace the valves without lapping the valve seats and valve faces.
- When replacing the valves or valve guides, use new valves to lap the valve seats, and then replace them with new valves.

Lapping steps:

- a. Apply a coarse lapping compound to the valve face.

NOTICE

Do not let the compound enter the gap between the valve stem and the guide.

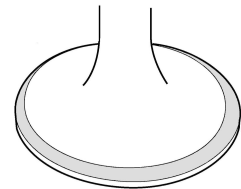

- b. Apply molybdenum disulfide oil to the valve stem.

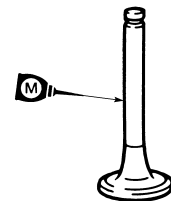

- c. Install the valve into the cylinder head.
- d. Turn the valve until the valve face and valve seat are evenly polished, then clean off all of the compound.

TIP

For best lapping results, lightly tap the valve seat while rotating the valve back and forth between your hands.

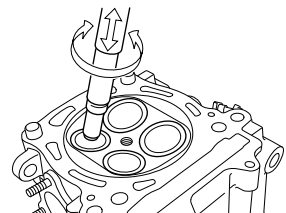

- e. Apply a fine lapping compound to the valve face and repeat the above steps.

TIP

After every lapping operation be sure to clean off all of the compound from the valve face and valve seat.

VALVES AND VALVE SPRINGS

- f. Apply Mechanic's blueing dye (Dykem) to the valve face.
- g. Install the valve into the cylinder head.
- h. Press the valve through the valve guide and onto the valve seat to make a clear pattern.
- i. Measure the valve seat width again. If the valve seat width is out of specification, reface and relap the valve seat.



CHECKING THE VALVE SPRINGS

1. Measure:
 - Valve spring free length "a"
 Out of specification → Replace.

	Free length (valve spring): Intake: 40.76 mm (1.60 in) <Limit>: 39.76 mm (1.57 in) Exhaust: 37.01 mm (1.46 in) <Limit>: 36.01 mm (1.42 in)
---	---

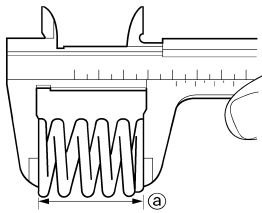

11171902

2. Measure:
 - Compressed spring force "a"
 Out of specification → Replace.

	Compressed spring force: Intake: 178–204 N at 34.78 mm (18.2–20.8 kg at 34.78 mm, 40.01–45.86 lb at 1.37 in) Exhaust: 124–142 N at 30.83 mm (12.6–14.5 kg at 30.83 mm, 27.88–31.92 lb at 1.21 in)
---	--

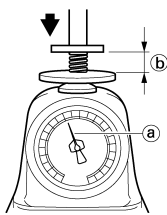

11171904

b. Installed length

3. Measure:
 - Spring tilt "a"
 Out of specification → Replace.

	Spring tilt limit: Intake: 2.5°/1.8 mm (0.070 in) Exhaust: 2.5°/1.6 mm (0.062 in)
---	--

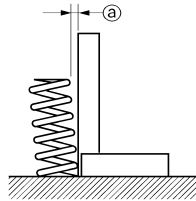

CHECKING THE VALVE LIFTERS

1. Inspect:
 - Valve lifter
 Scratches/damage → Replace both lifters and cylinder head.

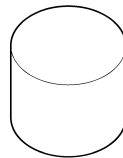

11170701

INSTALLING THE VALVES

1. Apply:
 - Molybdenum disulfide oil
 Onto the valve stem and valve stem seal.
2. Install:
 - Valves "1"
 - Valve spring seats "2"
 - Valve stem seals "3" **New**
 - Valve springs "4"
 - Valve spring retainers "5"

- TIP**
- Install the valve "a" with the identification 33DI on the intake side and the valve "b" with the identification 33DE on the exhaust side.
 - Install the valve springs with the larger pitch "d" facing upward.

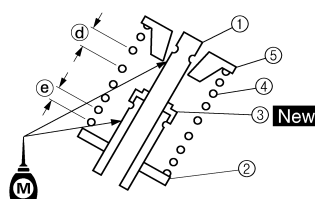
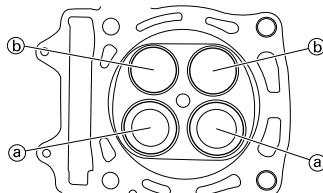

- e. Smaller pitch
3. Install:
 - Valve coppers

TIP

Install the valve coppers by compressing the valve spring with the valve spring compressor "1" and the valve spring compressor attachment "2".

	Valve spring compressor: YM-04019/90890-04019 Valve spring compressor attachment: YM-04108/90890-04108
---	---

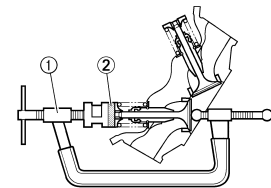

11171201

4. To secure the valve coppers onto the valve stem, lightly tap the valve tip with a piece of wood.

NOTICE

Hitting the valve tip with excessive force could damage the valve.

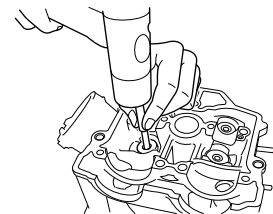

5. Install:
 - Adjusting pad "1"
 - Valve lifter "2"

TIP

- Apply the molybdenum disulfide oil on the valve stem end.
- Apply the engine oil on the valve lifters.
- Valve lifter must turn smoothly when rotated with a finger.
- Be careful to reinstall valve lifters and pads in their original place.

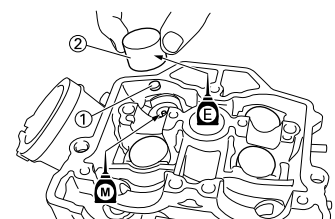

CYLINDER AND PISTON

CYLINDER AND PISTON

REMOVING THE CYLINDER AND PISTON

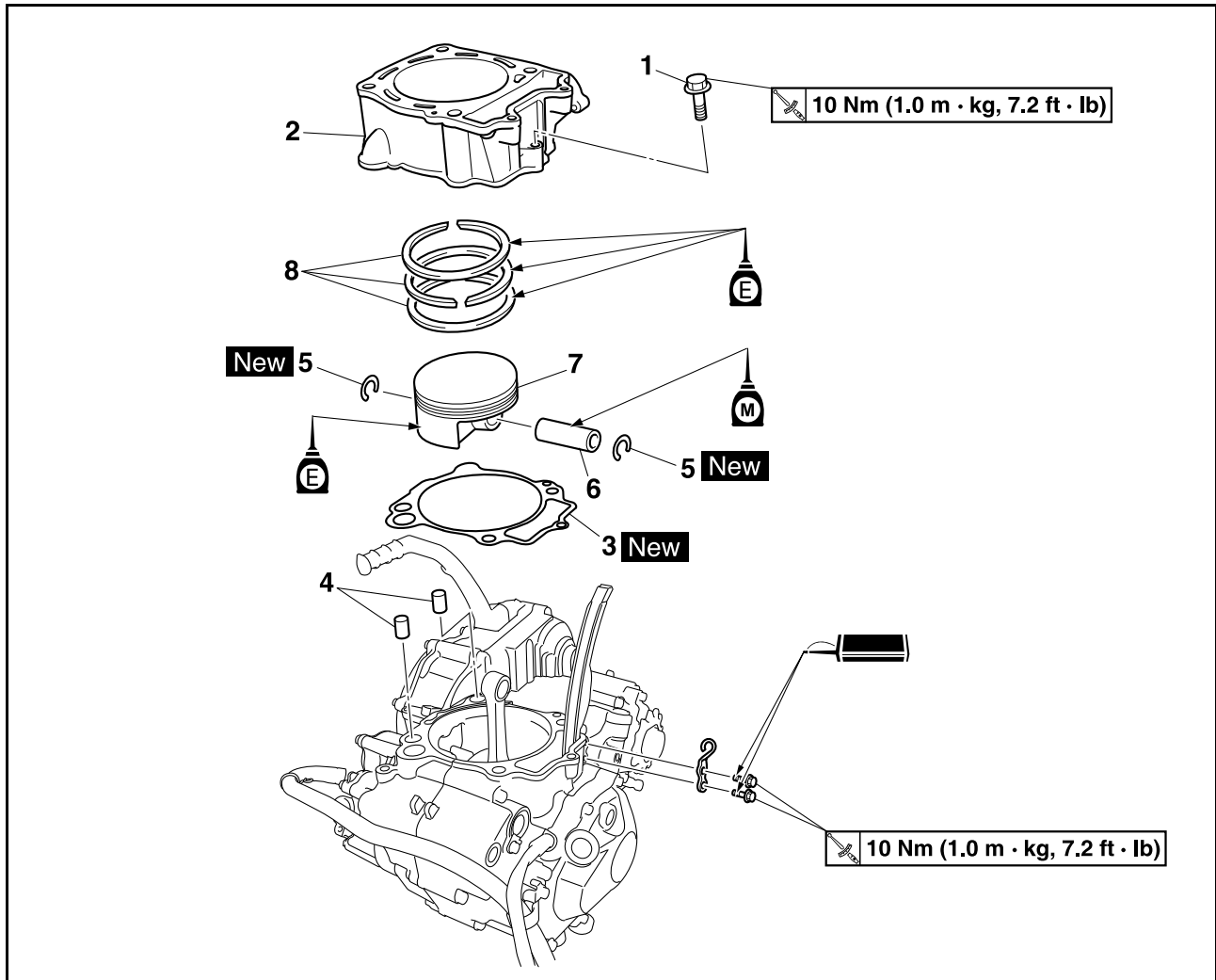

Order	Part name	Q'ty	Remarks
	Cylinder head		Refer to "CYLINDER HEAD" section.
1	Bolt (cylinder)	1	
2	Cylinder	1	
3	Gasket	1	
4	Dowel pin	2	
5	Piston pin clip	2	Refer to removal section.
6	Piston pin	1	Refer to removal section.
7	Piston	1	Refer to removal section.
8	Piston ring set	1	Refer to removal section.

CYLINDER AND PISTON

REMOVING THE PISTON AND PISTON RING

- Remove:
 - Piston pin clip "1"
 - Piston pin "2"
 - Piston "3"

TIP

- Put identification marks on each piston head for reference during re-installation.
- Before removing each piston pin, deburr the clip groove and pin hole area. If the piston pin groove is deburred and the piston pin is still difficult to remove, use the piston pin puller set "4".

	Piston pin puller set: YU-1304/90890-01304
---	---

NOTICE

Do not use a hammer to drive the piston pin out.

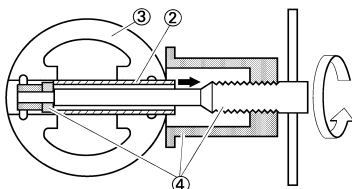
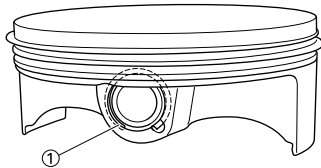

- Remove:
 - Piston ring "1"

TIP

Spread the end gaps apart while at the same time lifting the piston ring over the top of the piston crown, as shown in the illustration.

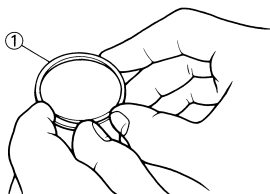

CHECKING THE CYLINDER AND PISTON

- Inspect:
 - Cylinder and piston walls
Vertical scratches → Replace cylinder and piston.
- Measure:
 - Piston-to-cylinder clearance



Measurement steps:

- Measure the cylinder bore "C" with a cylinder bore gauge.

TIP

Measure the cylinder bore "C" in parallel to and at right angles to the crankshaft. Then, find the average of the measurements.

Cylinder bore "C"	97.00–97.01 mm (3.8189–3.8193 in)
Taper limit "T"	0.05 mm (0.002 in)
Out of round "R"	0.05 mm (0.002 in)

"C" = Maximum D
"T" = (Maximum D₁ or D₂) - (Maximum D₅ or D₆)
"R" = (Maximum D₁, D₃ or D₅) - (Minimum D₂, D₄ or D₆)

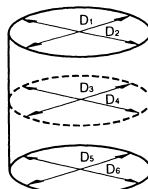

11210102

- If out of specification, replace the cylinder, and replace the piston and piston rings as set.
- Measure the piston skirt diameter "P" with a micrometer.

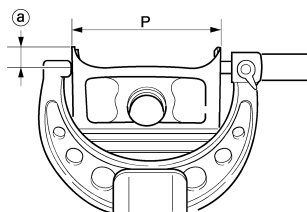

- 9 mm (0.35 in) from the piston bottom edge.

	Piston size "P"
Standard	96.965–96.980 mm (3.8175–3.8181 in)

- If out of specification, replace the piston and piston rings as a set.

- Calculate the piston-to-cylinder clearance with following formula:

Piston-to-cylinder clearance = Cylinder bore "C" - Piston skirt diameter "P"



Piston-to-cylinder clearance: 0.020–0.045 mm (0.0008–0.0018 in) <Limit>: 0.1 mm (0.004 in)

- If out of specification, replace the cylinder, and replace the piston and piston rings as set.



CHECKING THE PISTON RING

- Measure:
 - Ring side clearance
Use a feeler gauge "1".
Out of specification → Replace the piston and rings as a set.

TIP

Clean carbon from the piston ring grooves and rings before measuring the side clearance.

	Side clearance:	
	Standard	<Limit>
Top ring	0.015–0.065 mm (0.0006–0.0026 in)	0.12 mm (0.005 in)
2nd ring	0.020–0.060 mm (0.0008–0.0024 in)	0.12 mm (0.005 in)

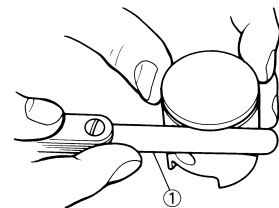

CYLINDER AND PISTON

2. Position:

- Piston ring (in cylinder)

TIP

Insert a ring into the cylinder and push it approximately 40mm (1.57 in) into the cylinder. Push the ring with the piston crown so that the ring will be at a right angle to the cylinder bore.

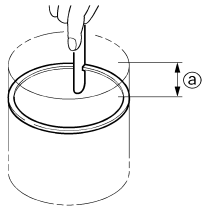

11221401

- a. 40 mm (1.57 in)

3. Measure:

- Ring end gap
Out of specification → Replace.

TIP

You cannot measure the end gap on the expander spacer of the oil control ring. If the oil control ring rails show excessive gap, replace all three rings.

	End gap:	
	Standard	<Limit>
Top ring	0.20–0.30 mm (0.008–0.012 in)	0.55 mm (0.022 in)
2nd ring	0.35–0.50 mm (0.014–0.020 in)	0.85 mm (0.033 in)
Oil ring	0.20–0.50 mm (0.008–0.020 in)	—

CHECKING THE PISTON PIN

1. Inspect:

- Piston pin
Blue discoloration/grooves → Replace, then inspect the lubrication system.

2. Measure:

- Piston pin-to-piston clearance



Measurement steps:

- a. Measure the outside diameter (piston pin) "a".

If out of specification, replace the piston pin.

Outside diameter (piston pin):
17.991–18.000 mm
(0.7083–0.7087 in)

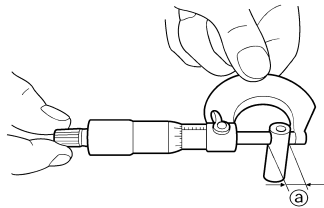

- b. Measure the inside diameter (piston) "b".

Inside diameter (piston):
18.004–18.015 mm
(0.7088–0.7093 in)

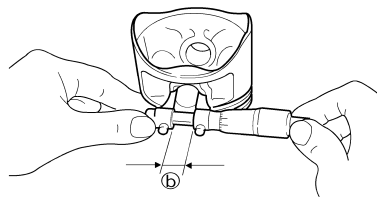

- c. Calculate the piston pin-to-piston clearance with the following formula.

Piston pin-to-piston clearance =
Inside diameter (piston) "b" -
Outside diameter (piston pin) "a"

- d. If out of specification, replace the piston.

Piston pin-to-piston clearance:
0.004–0.024 mm
(0.00016–0.00094 in)
<Limit>: 0.07 mm (0.003 in)



INSTALLING THE PISTON RING AND PISTON

1. Install:

- Piston ring
Onto the piston.

TIP

- Be sure to install the piston rings so that the manufacturer's marks or numbers are located on the upper side of the rings.
- Lubricate the piston and piston rings liberally with engine oil.

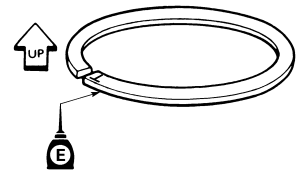

2. Position:

- Top ring
- 2nd ring
- Oil ring
Offset the piston ring end gaps as shown.

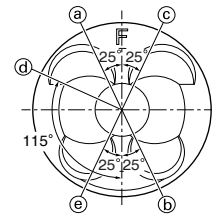

- a. Top ring end
b. 2nd ring end
c. Oil ring end (upper)
d. Oil ring
e. Oil ring end (lower)

CYLINDER AND PISTON

3. Install:

- Piston "1"
- Piston pin "2"
- Piston pin clip "3" **New**

TIP

- Apply engine oil onto the piston.
- Apply molybdenum disulfide oil onto the piston pin.
- Install the piston with the F mark "a" on it pointing to its intake (front) side.
- Before installing the piston pin clip, cover the crankcase with a clean rag to prevent the piston pin clip from falling into the crankcase.

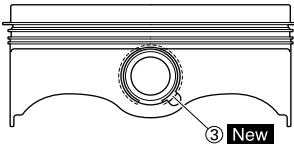
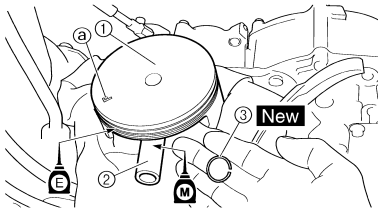

INSTALLING THE CYLINDER

1. Install:

- Dowel pins
- Cylinder gasket "1" **New**
- Cylinder "2"

TIP

Install the cylinder with one hand while compressing the piston rings with the other hand.

NOTICE

- Pass the timing chain "3" through the timing chain cavity.
- Be careful not to damage the timing chain guide "4" during installation.

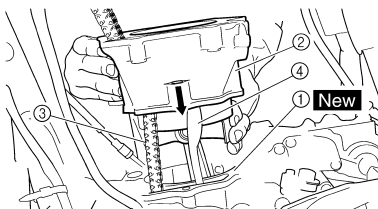

2. Install:

- Bolt (cylinder)

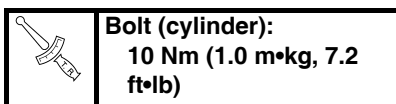

CLUTCH
REMOVING THE CLUTCH

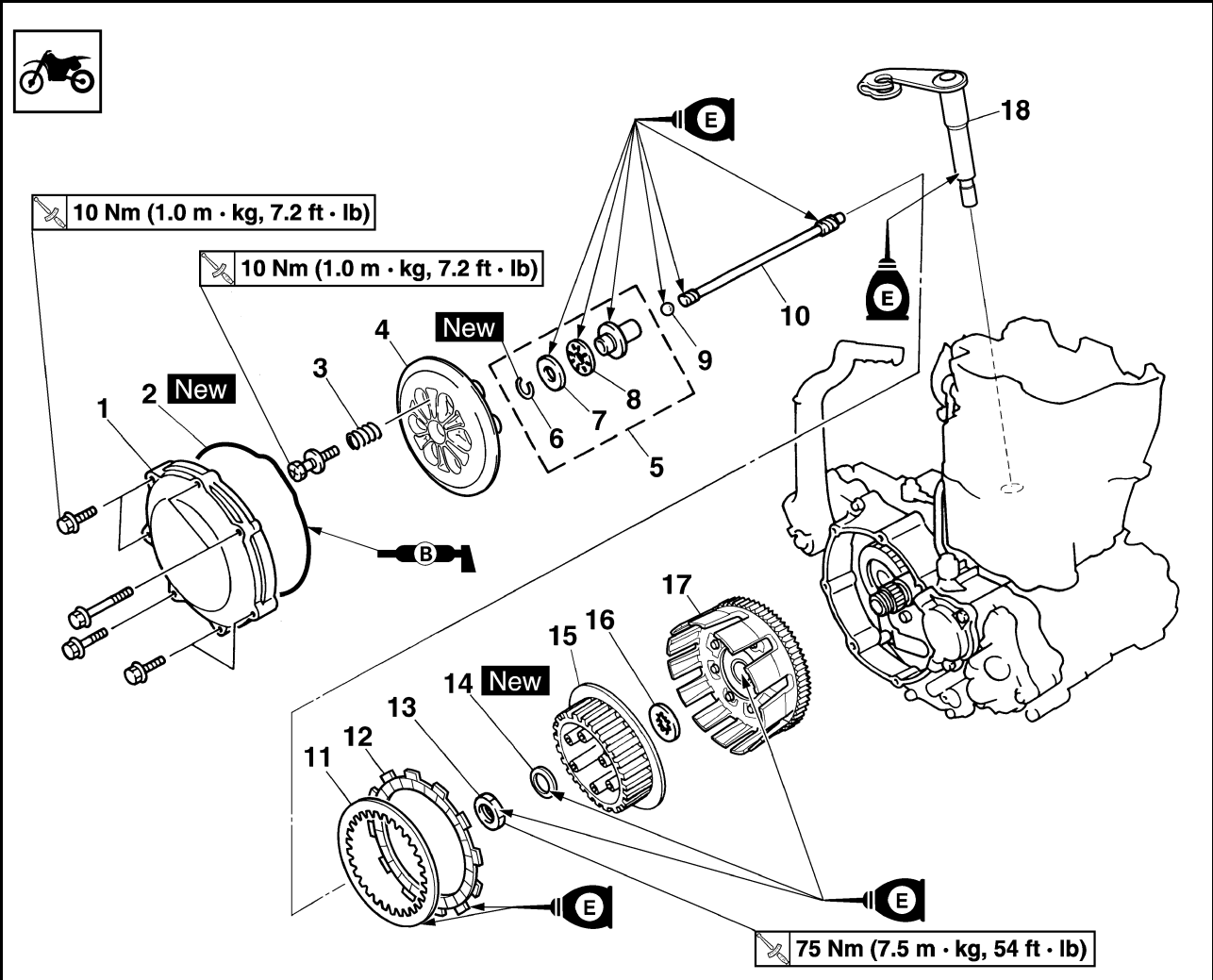

Order	Part name	Q'ty	Remarks
	Drain the engine oil.		Refer to "CHANGING THE ENGINE OIL" section in the CHAPTER 3.
	Brake pedal		Refer to "ENGINE REMOVAL" section.
	Clutch cable		Disconnect at engine side.
1	Clutch cover	1	
2	Gasket	1	
3	Clutch spring	6	
4	Pressure plate	1	
5	Push rod 1	1	
6	Circlip	1	
7	Washer	1	
8	Bearing	1	
9	Ball	1	
10	Push rod 2	1	
11	Clutch plate	7	
12	Friction plate	8	
13	Nut (clutch boss)	1	Refer to removal section.

CLUTCH

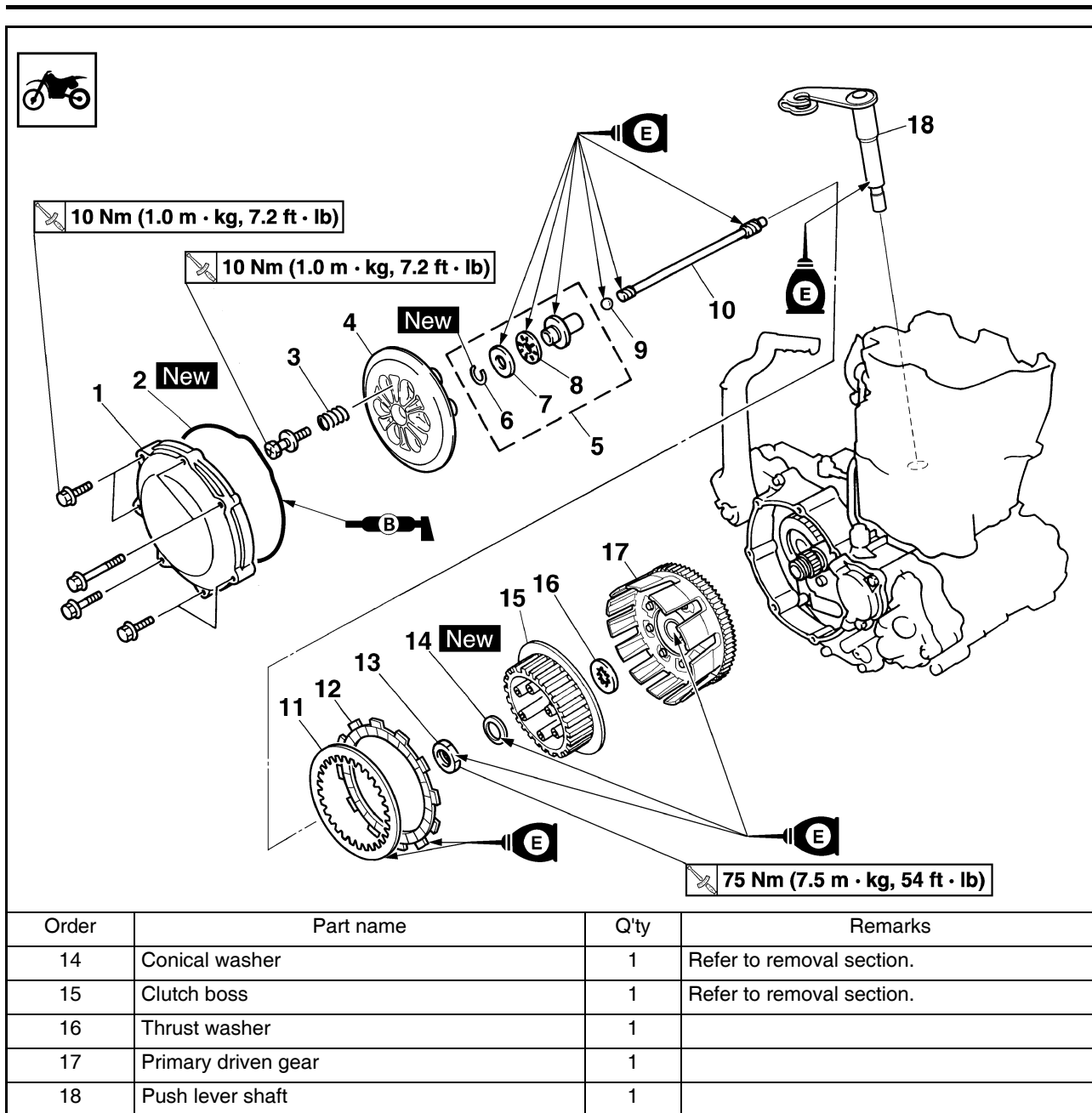

REMOVING THE CLUTCH BOSS

- Remove:
 - Nut "1"
 - Conical washer "2"
 - Clutch boss "3"

TIP

Use the clutch holding tool "4" to hold the clutch boss.

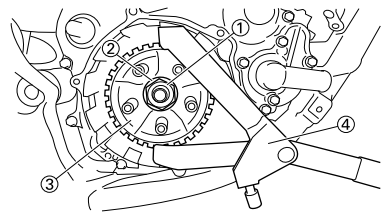
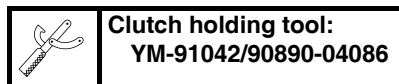

A

B

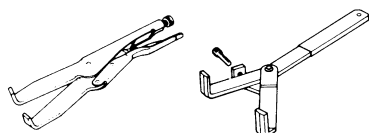

A. For USA and CDN

B. Except for USA and CDN

CHECKING THE CLUTCH HOUSING AND BOSS

- Inspect:
 - Clutch housing "1"
Cracks/wear/damage → Replace.
 - Clutch boss "2"
Scoring/wear/damage → Replace.

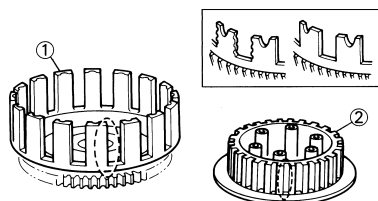

CHECKING THE PRIMARY DRIVEN GEAR

- Check:
 - Circumferential play
Free play exists → Replace.
 - Gear teeth "a"
Wear/damage → Replace.

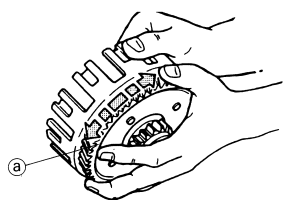

311-021

CHECKING THE CLUTCH SPRINGS

- Measure:
 - Clutch spring free length "a"
Out of specification → Replace
springs as a set.

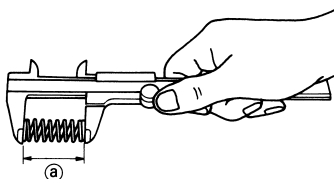
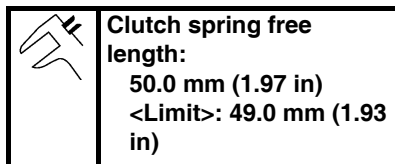

CHECKING THE FRICTION PLATES

- Measure:
 - Friction plate thickness
Out of specification → Replace
friction plate as a set.
Measure at all four points.

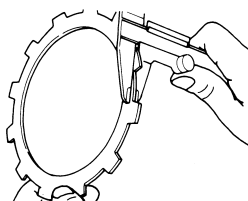
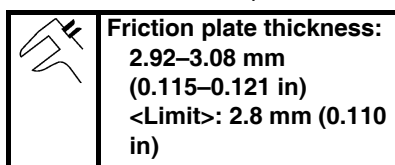

CHECKING THE CLUTCH PLATES

- Measure:
 - Clutch plate warpage
Out of specification → Replace
clutch plate as a set.
Use a surface plate "1" and thick-
ness gauge "2".

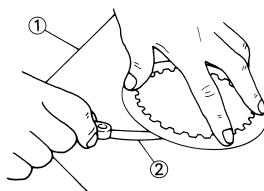
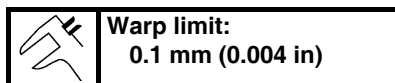

CHECKING THE PUSH LEVER SHAFT

- Inspect:
 - Push lever shaft "1"
Wear/damage → Replace.

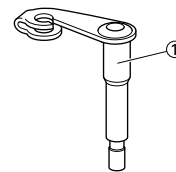

CHECKING THE PUSH ROD

- Inspect:
 - Push rod 1 "1"
 - Bearing "2"
 - Washer "3"
 - Push rod 2 "4"
 - Ball "5"
 Wear/damage/bend → Replace.

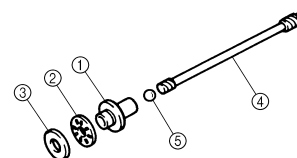

INSTALLING THE PUSH LEVER SHAFT

- Install:
 - Push lever shaft "1"

TIP

- Apply the lithium soap base grease on the oil seal lip.
- Apply the engine oil on the push lever shaft.

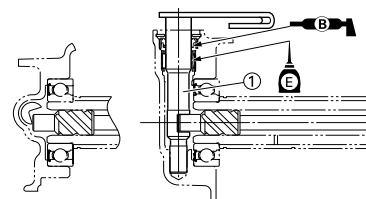

INSTALLING THE CLUTCH

1. Install:
 - Primary driven gear "1"
 - Thrust washer "2"
 - Clutch boss "3"

TIP
Apply the engine oil on the primary driven gear inner circumference.

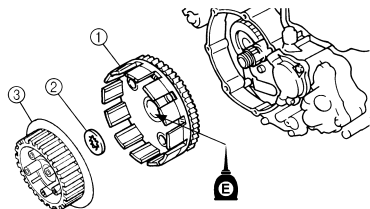

2. Install:
 - Conical washer "1" **New**
 - Nut (clutch boss) "2"

	Nut (clutch boss): 75 Nm (7.5 m•kg, 54 ft•lb)
--	---

NOTICE

Make sure to tighten to specification; otherwise, it may damage the other part that is fastened together.

- TIP**
- Apply engine oil to the threads and contact surface of the clutch boss nut.
 - Apply engine oil to the contact surfaces of the conical washer.
 - Install the conical washer with its convex surface "a" outward.
 - Use the clutch holding tool "3" to hold the clutch boss.

	Clutch holding tool: YM-91042/90890-04086
--	---

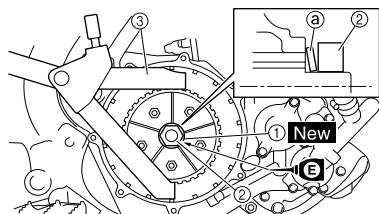

A

B

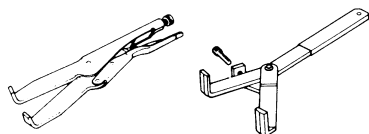

- For USA and CDN
- Except for USA and CDN

3. Install:
 - Friction plate "1"
 - Clutch plate "2"

TIP
Install the clutch plates and friction plates alternately on the clutch boss, starting with a friction plate and ending with a friction plate.
Apply the engine oil on the friction plates and clutch plates.

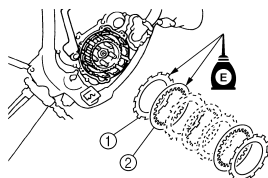

4. Install:
 - Bearing "1"
 - Washer "2"
 - Circlip "3" **New**
 To push rod 1 "4".

TIP
Apply the engine oil on the bearing and washer.

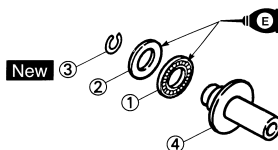

5. Install:
 - Push rod 2 "1"
 - Ball "2"
 - Push rod 1 "3"

TIP
Apply the engine oil on the push rod 1, 2 and ball.

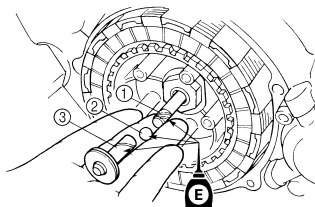

6. Install:
 - Pressure plate "1"

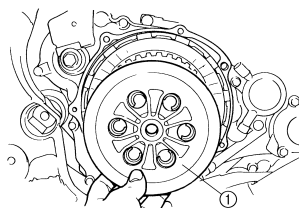

7. Install:
 - Clutch spring
 - Bolt (clutch spring)

	Bolt (clutch spring): 10 Nm (1.0 m•kg, 7.2 ft•lb)
--	---

TIP
Tighten the bolts in stage, using a crisscross pattern.

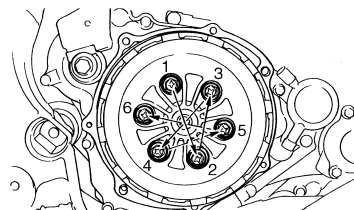

8. Install:
 - O-ring (clutch cover) "1" **New**

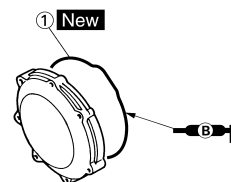

9. Install:
 - Clutch cover "1"
 - Bolt (clutch cover)

	Bolt (clutch cover): 10 Nm (1.0 m•kg, 7.2 ft•lb)
--	--

TIP
Tighten the bolts in stage, using a crisscross pattern.

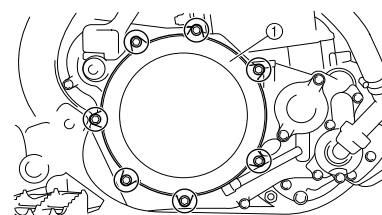

OIL FILTER ELEMENT AND WATER PUMP

OIL FILTER ELEMENT AND WATER PUMP

REMOVING THE OIL FILTER ELEMENT AND WATER PUMP

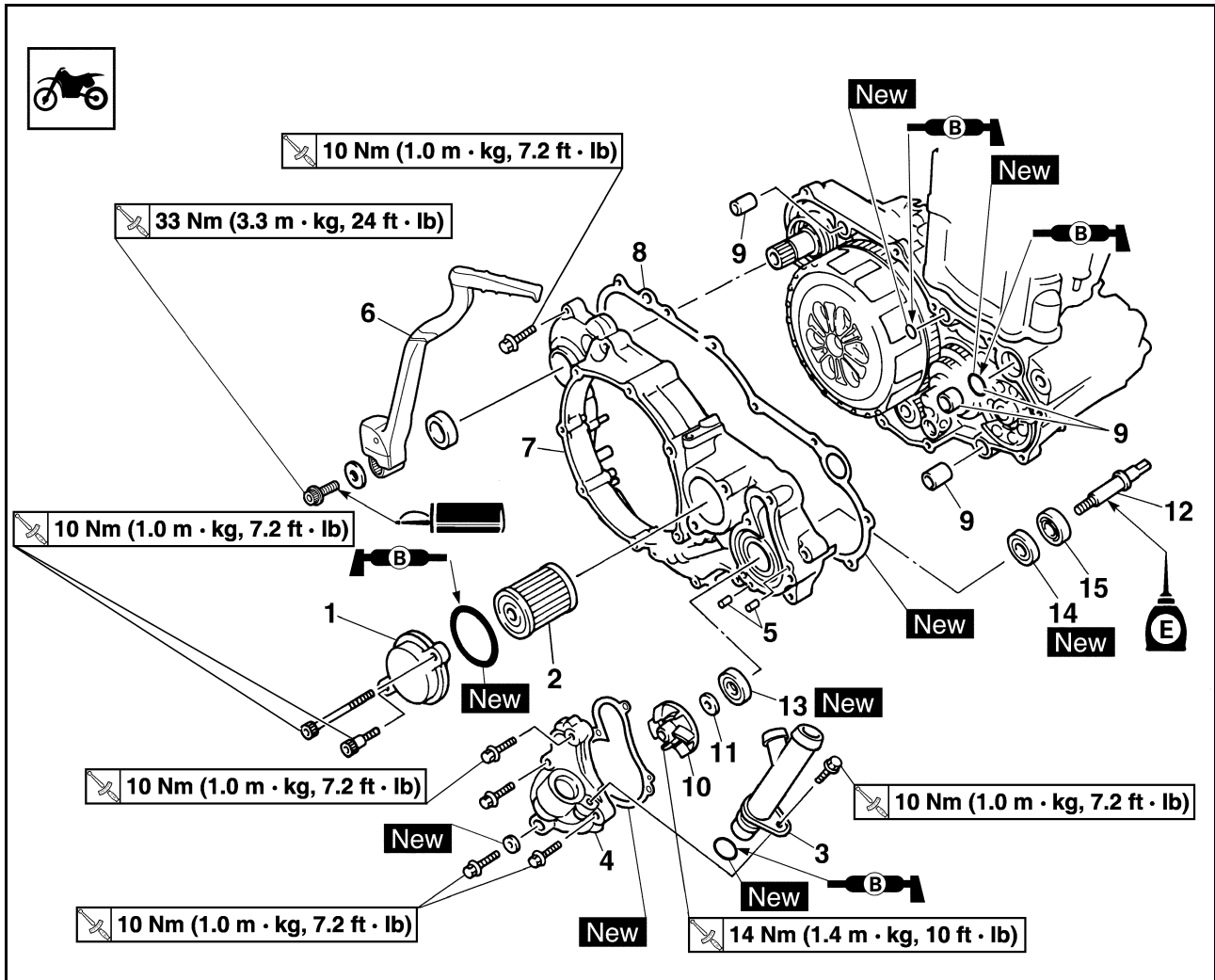

Order	Part name	Q'ty	Remarks
	Right engine guard		Refer to "ENGINE REMOVAL" section.
	Drain the engine oil.		Refer to "CHANGING THE ENGINE OIL" section in the CHAPTER 3.
	Drain the coolant.		Refer to "CHANGING THE COOLANT" section.
	Exhaust pipe		Refer to "EXHAUST PIPE AND SILENCER" section.
	Brake pedal		Refer to "ENGINE REMOVAL" section.
	Clutch cover		Refer to "CLUTCH" section.
1	Oil filter element cover	1	
2	Oil filter element	1	
3	Radiator pipe	1	
4	Water pump housing	1	
5	Dowel pin	2	
6	Kickstarter crank	1	
7	Right crankcase cover	1	
8	Gasket	1	

OIL FILTER ELEMENT AND WATER PUMP

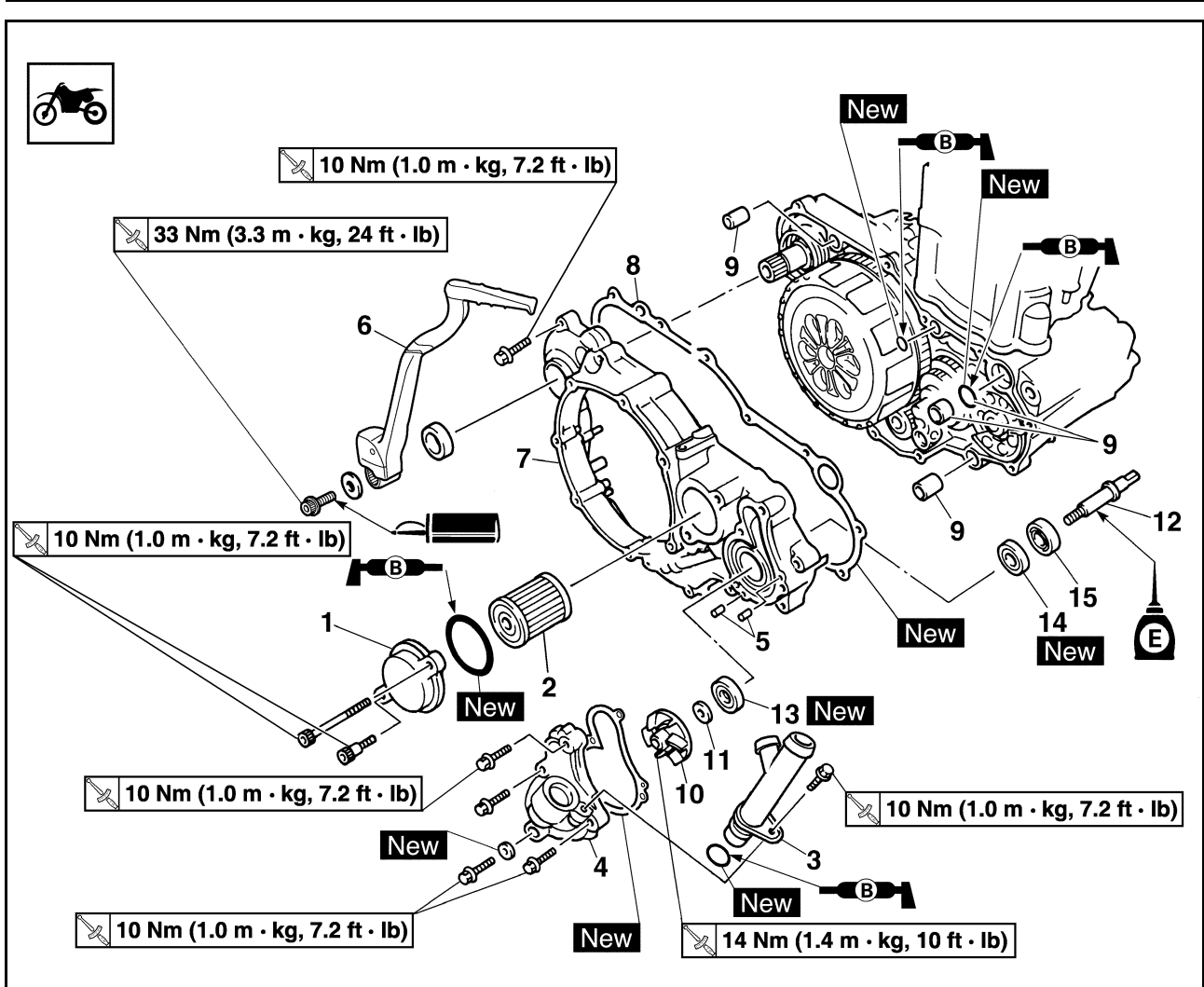

Order	Part name	Q'ty	Remarks
9	Dowel pin/O-ring	3/1	
10	Impeller	1	Refer to removal section.
11	Washer	1	Refer to removal section.
12	Impeller shaft	1	Refer to removal section.
13	Oil seal 1	1	Refer to removal section.
14	Oil seal 2	1	Refer to removal section.
15	Bearing	1	Refer to removal section.

OIL FILTER ELEMENT AND WATER PUMP

REMOVING THE IMPELLER SHAFT

- Remove:
 - Impeller "1"
 - Washer "2"
 - Impeller shaft "3"

TIP

Hold the impeller shaft on its width across the flats "a" with spanners, etc. and remove the impeller.

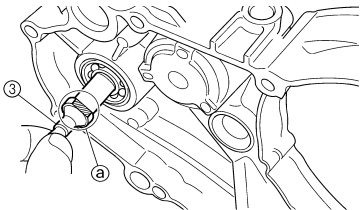
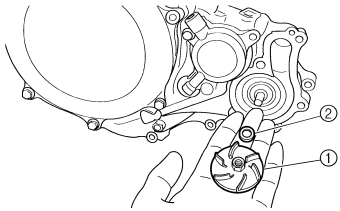

REMOVING THE OIL SEAL

TIP

It is not necessary to disassemble the water pump, unless there is an abnormality such as excessive change in coolant level, discoloration of coolant, or milky transmission oil.

- Remove:
 - Bearing "1"
 - Oil seal "2"

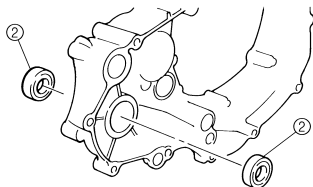
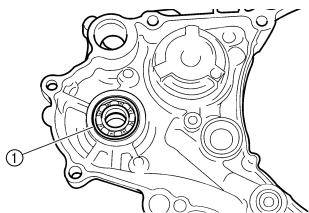

CHECKING THE IMPELLER SHAFT

- Inspect:
 - Impeller shaft "1"
Bend/wear/damage → Replace.
Fur deposits → Clean.

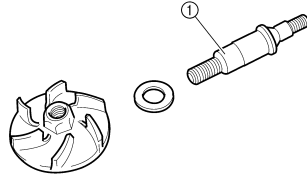

CHECKING THE BEARING

- Inspect:
 - Bearing
Rotate inner race with a finger.
Rough spot/seizure → Replace.

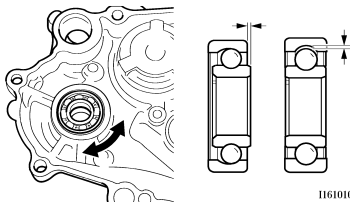

CHECKING THE OIL SEAL

- Inspect:
 - Oil seal "1"
Wear/damage → Replace.

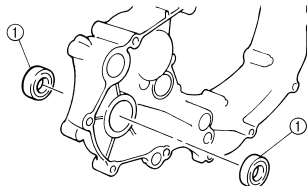

INSTALLING THE OIL SEAL

- Install:
 - Oil seal "1" **New**

TIP

- Apply the lithium soap base grease on the oil seal lip.
- Install the oil seal with its manufacturer's marks or numbers facing the right crankcase cover "2".

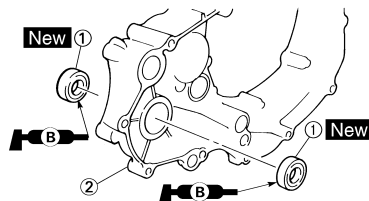

- Install:
 - Bearing "1"

TIP

Install the bearing by pressing its outer race parallel.

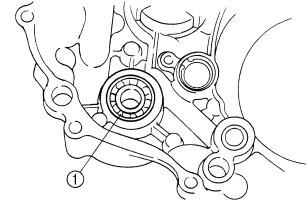

INSTALLING THE IMPELLER SHAFT

- Install:
 - Impeller shaft "1"
 - Washer "2"
 - Impeller "3"

	Impeller: 14 Nm (1.4 m•kg, 10 ft•lb)
---	--

TIP

- Take care so that the oil seal lip is not damaged or the spring does not slip off its position.
- When installing the impeller shaft, apply the engine oil on the oil seal lip, bearing and impeller shaft. And install the shaft while turning it.
- Hold the impeller shaft on its width across the flats "a" with spanners, etc. and install the impeller.

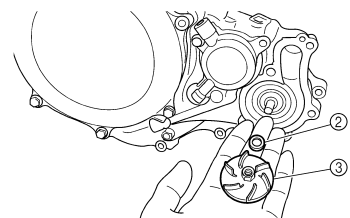
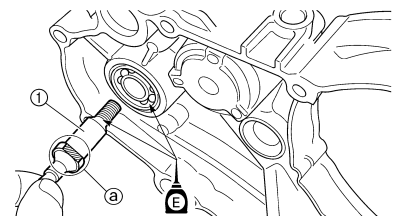

OIL FILTER ELEMENT AND WATER PUMP

INSTALLING THE RIGHT CRANKCASE COVER

- Install:
 - Dowel pin "1"
 - O-ring "2" **New**
 - Collar "3"
 - Gasket "4" **New**

TIP
Apply the lithium soap base grease on the O-ring.

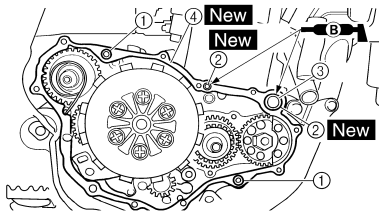

- Install:
 - Right crankcase cover "1"
 - Bolt "2"

	Bolt: 10 Nm (1.0 m•kg, 7.2 ft•lb)
---	---

- TIP**
- Apply the engine oil on the impeller shaft end.
 - When installing the crankcase cover onto the crankcase, be sure that the impeller shaft end "3" aligns with the balancer end slot "4".
 - Tighten the bolts in stage, using a crisscross pattern.

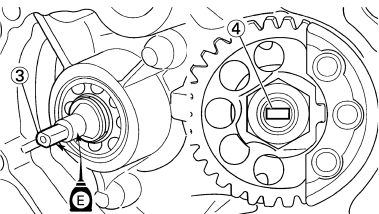
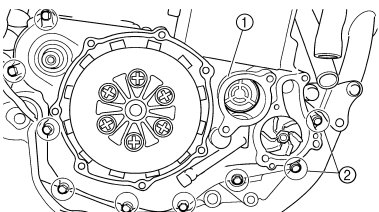

INSTALLING THE KICKSTARTER CRANK

- Install:
 - Kickstarter crank "1"
 - Washer
 - Bolt (kickstarter crank) 

	Bolt (kickstarter crank): 33 Nm (3.3 m•kg, 24 ft•lb)
---	--

TIP
Install so that there is a clearance "a" of 8 mm (0.31 in) or more between the kickstarter and frame and that the kickstarter does not contact the crankcase cover when it is pulled.

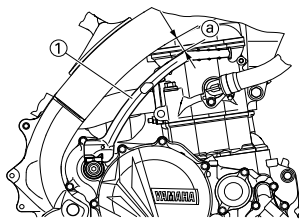

INSTALLING THE WATER PUMP HOUSING

- Install:
 - Dowel pin "1"
 - Gasket "2" **New**

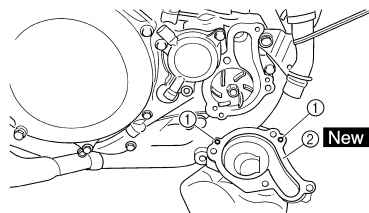

- Install:
 - Water pump housing "1"
 - Bolt (water pump housing) "2"

	Bolt (water pump housing): 10 Nm (1.0 m•kg, 7.2 ft•lb)
---	--

- Washer "3" **New**
- Coolant drain bolt "4"

	Coolant drain bolt: 10 Nm (1.0 m•kg, 7.2 ft•lb)
---	---

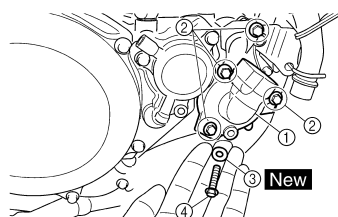

- Install:
 - O-ring **New**
 - Coolant pipe "1"
 - Bolt (radiator pipe) "2"

	Bolt (radiator pipe): 10 Nm (1.0 m•kg, 7.2 ft•lb)
---	---

TIP
Apply the lithium soap base grease on the O-ring.

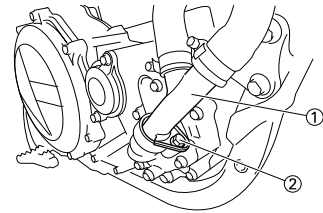

INSTALLING THE OIL FILTER ELEMENT

- Install:
 - Oil filter element "1"
 - O-ring "2" **New**
 - Oil filter element cover "3"
 - Bolt (oil filter element cover)

	Bolt (oil filter element cover): 10 Nm (1.0 m•kg, 7.2 ft•lb)
---	--

TIP
Apply the lithium soap base grease on the O-ring.

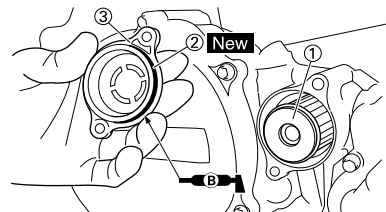

BALANCER REMOVING THE BALANCER

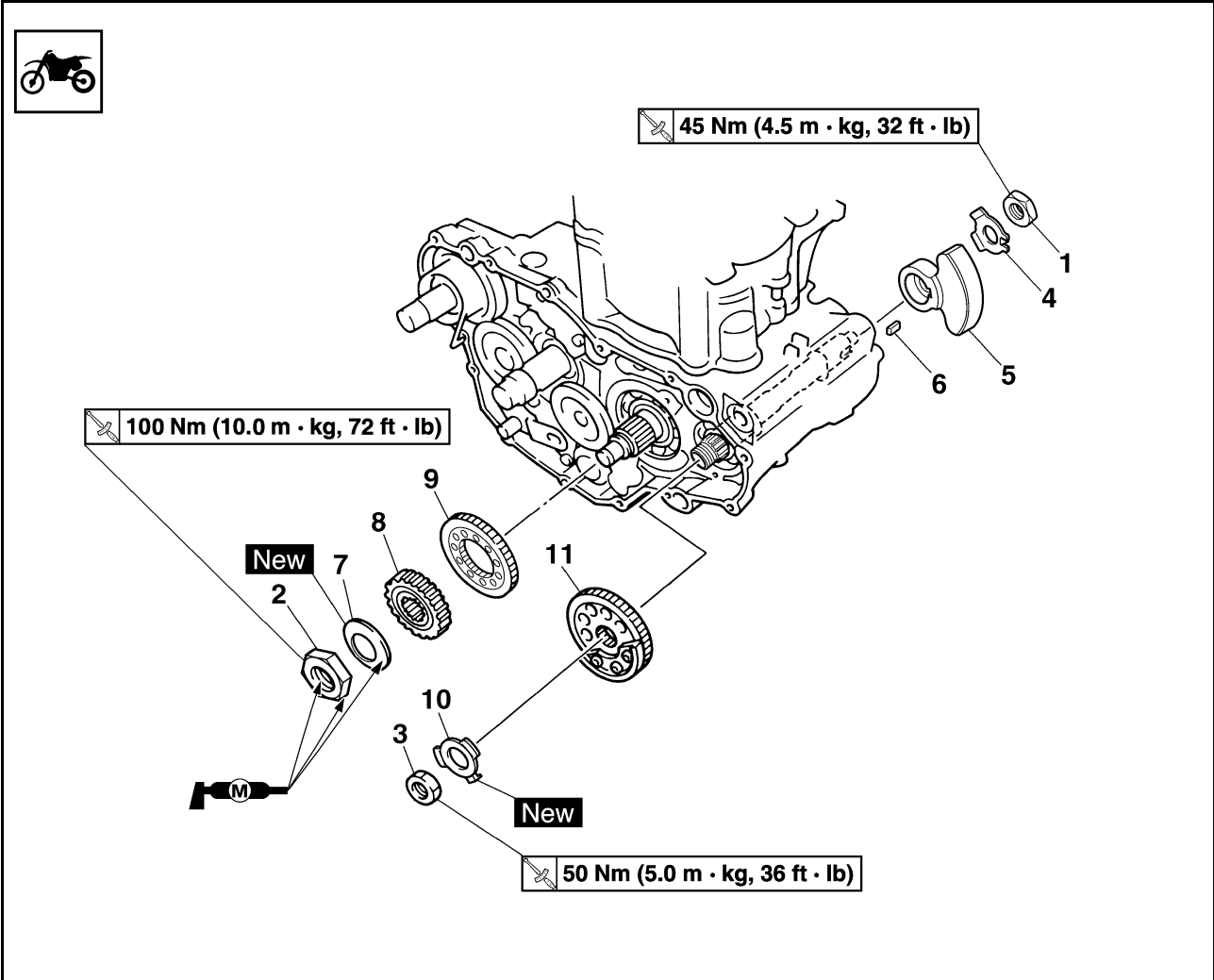

Order	Part name	Q'ty	Remarks
	Primary driven gear		Refer to "CLUTCH" section.
	Right crankcase cover		Refer to "OIL FILTER ELEMENT AND WATER PUMP" section.
	Stator		Refer to "AC MAGNETO" section.
1	Nut (balancer)	1	Refer to removal section.
2	Nut (primary drive gear)	1	Refer to removal section.
3	Nut (balancer shaft driven gear)	1	Refer to removal section.
4	Lock washer	1	
5	Balancer	1	
6	Straight key	1	
7	Conical washer	1	
8	Primary drive gear	1	
9	Balancer shaft drive gear	1	
10	Lock washer	1	
11	Balancer shaft driven gear	1	

BALANCER

REMOVING THE BALANCER

1. Straighten the lock washer tab.
2. Loosen:
 - Nut (balancer) "1"
 - Nut (primary drive gear) "2"
 - Nut (balancer shaft driven gear) "3"

TIP

Place an aluminum plate "a" between the teeth of the balancer shaft drive gear "4" and driven gear "5".

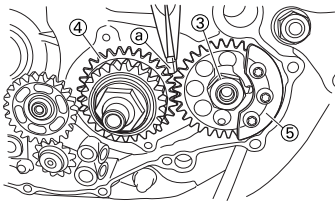
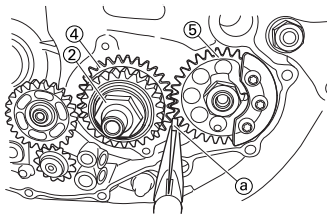
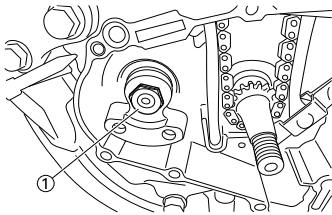

CHECKING THE PRIMARY DRIVE GEAR, BALANCER SHAFT DRIVE GEAR AND BALANCER SHAFT DRIVEN GEAR

1. Inspect:
 - Primary drive gear "1"
 - Balancer shaft drive gear "2"
 - Balancer shaft driven gear "3"
 Wear/damage → Replace.

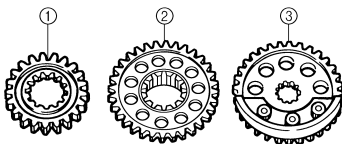

CHECKING THE BALANCER

1. Inspect:
 - Balancer
 Cracks/damage → Replace.

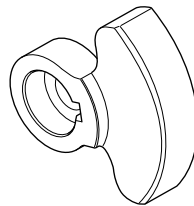

INSTALLING THE BALANCER

1. Install:
 - Balancer shaft driven gear "1"

TIP

Install the balancer shaft driven gear and balancer shaft with their lower splines "a" aligning with each other.

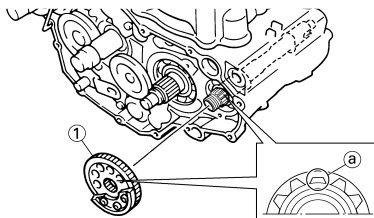

2. Install:
 - Balancer shaft driven gear "1"

TIP

- Align the punched mark "a" on the balancer shaft drive gear with the punched mark "b" on the balancer shaft driven gear.
- Install the balancer shaft driven gear and crankshaft with the lower splines "c" aligning with each other.

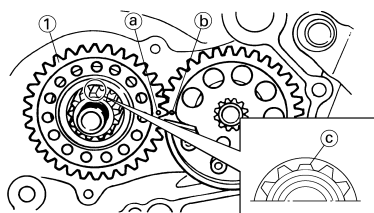

3. Install:
 - Lock washer "1"
 - Nut (balancer shaft driven gear) "2"

	Nut (balancer shaft driven gear): 50 Nm (5.0 m•kg, 36 ft•lb)
---	--

- Primary drive gear "3"
- Conical washer "4"
- Nut (primary drive gear) "5"

	Nut (primary drive gear): 100 Nm (10.0 m•kg, 72 ft•lb)
---	--

- Straight key "6"
- Balancer "7"
- Lock washer "8"
- Nut (balancer) "9"

	Nut (balancer): 45 Nm (4.5 m•kg, 33 ft•lb)
---	--

TIP

- Apply molybdenum disulfide grease to the contact surface and threaded portion of the nut (primary drive gear).
- Apply molybdenum disulfide grease to the contact surface of the conical spring washer.
- Place an aluminum plate "a" between the teeth of the balancer shaft drive gear "10" and balancer shaft driven gear "11".
- Install the conical washer with its convex surface "b" outward.

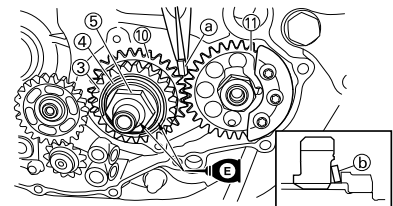
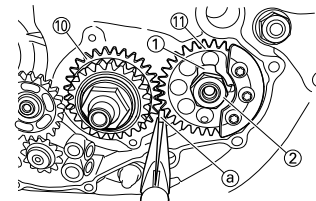

4. Bend the lock washer tab.

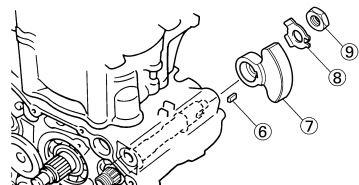

OIL PUMP

REMOVING THE OIL PUMP

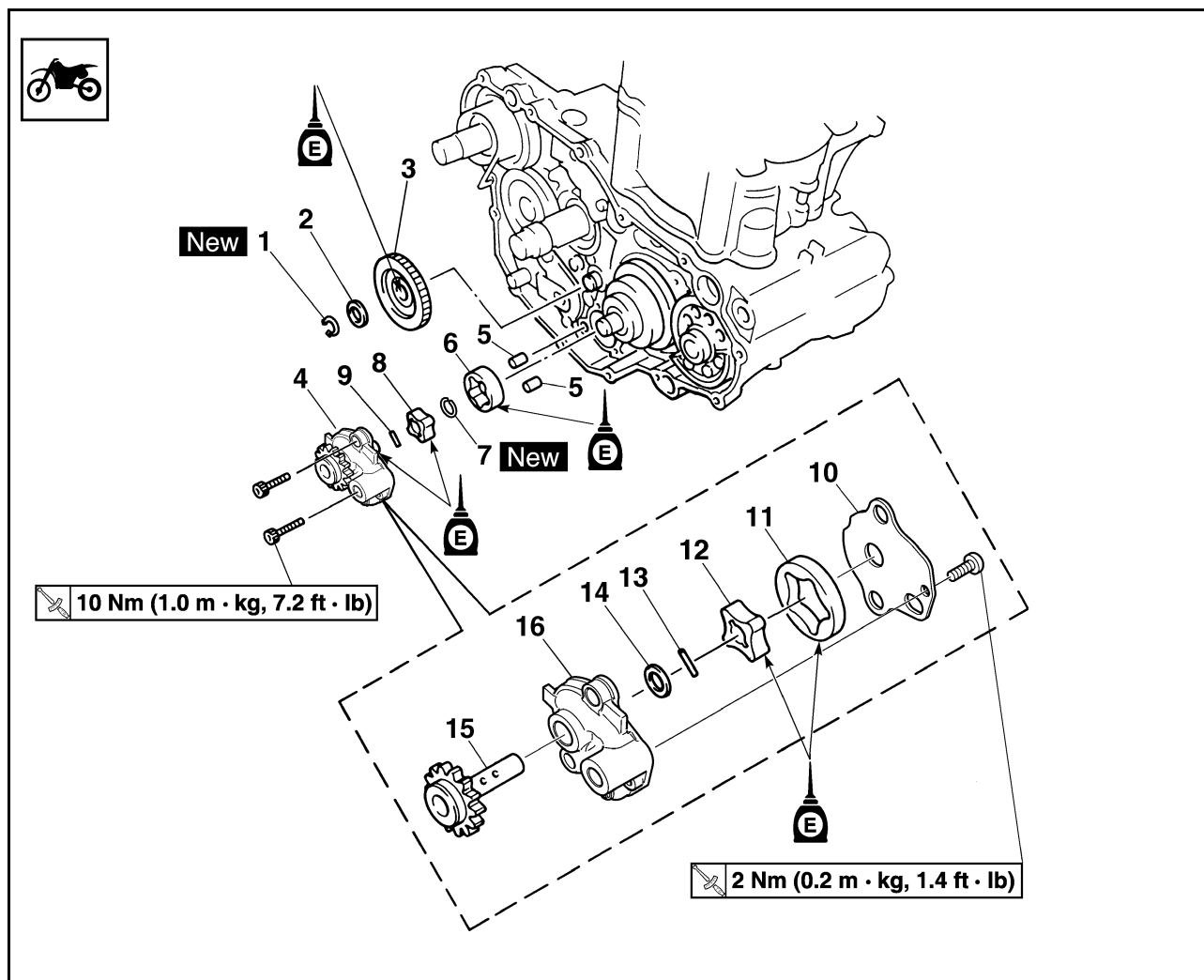

Order	Part name	Q'ty	Remarks
	Primary driven gear		Refer to "CLUTCH" section.
	Right crankcase cover		Refer to "OIL FILTER ELEMENT AND WATER PUMP" section.
1	Circlip	1	
2	Washer	1	
3	Oil pump drive gear	1	
4	Oil pump assembly	1	
5	Dowel pin	2	
6	Outer rotor 2	1	
7	Circlip	1	
8	Inner rotor 2	1	
9	Dowel pin	1	
10	Oil pump cover	1	
11	Outer rotor 1	1	
12	Inner rotor 1	1	
13	Dowel pin	1	
14	Washer	1	

OIL PUMP

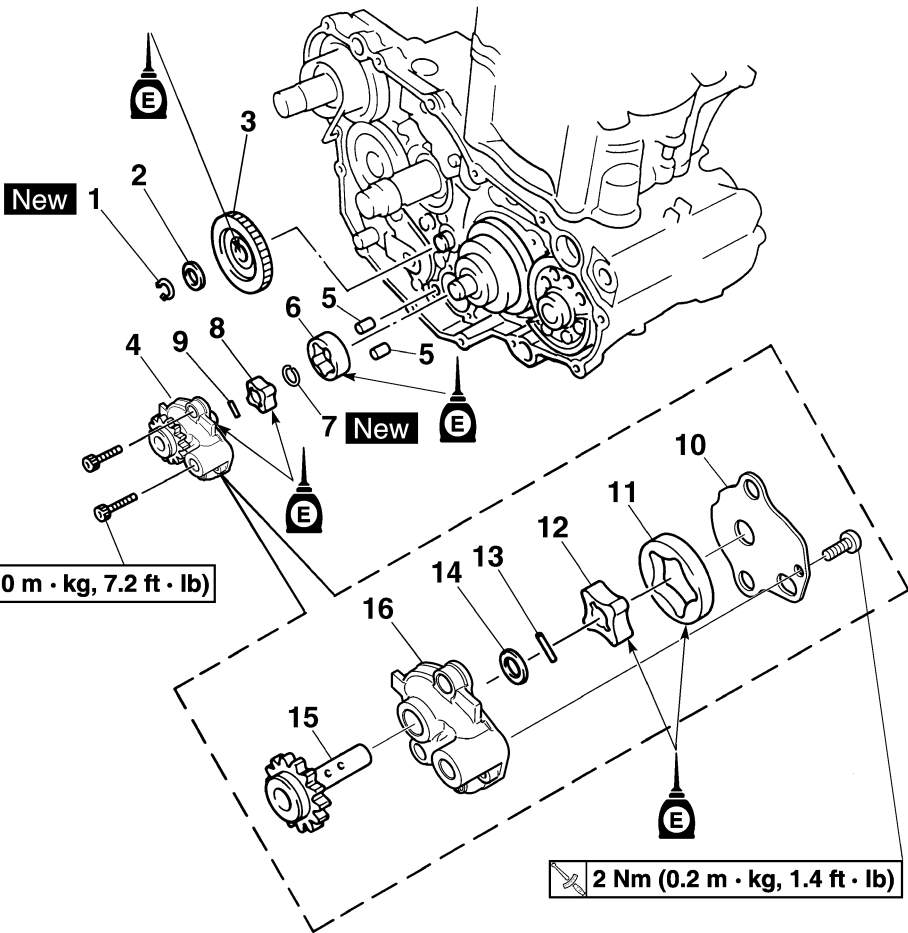

Order	Part name	Q'ty	Remarks
15	Oil pump drive shaft	1	
16	Rotor housing	1	

CHECKING THE OIL PUMP

- Inspect:
 - Oil pump drive gear
 - Oil pump drive shaft
 - Rotor housing
 - Oil pump cover
 Cracks/wear/damage → Replace.
- Measure:
 - Tip clearance "a" (between the inner rotor "1" and outer rotor "2")
 - Side clearance "b" (between the outer rotor "2" and rotor housing "3")
 - Housing and rotor clearance "c" (between the rotor housing "3" and rotors "1" "2")
 Out of specification → Replace the oil pump assembly.



Tip clearance "a":
0.12 mm or less (0.0047 in or less)
 <Limit>: 0.20 mm (0.008 in)

Side clearance "b":
0.09–0.17 mm (0.0035–0.0067 in)
 <Limit>: 0.24 mm (0.009 in)

Housing and rotor clearance "c":
0.03–0.10 mm (0.0012–0.0039 in)
 <Limit>: 0.17 mm (0.0067 in)

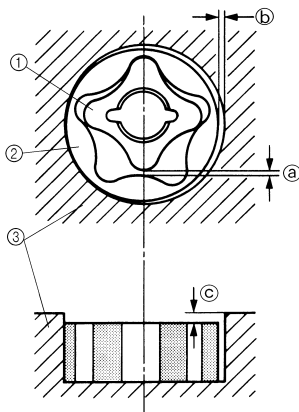

- Check:
 - Unsmooth → Repeat steps #1 and #2 or replace the defective parts.

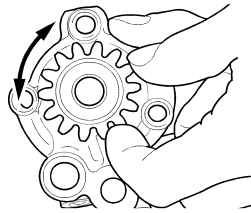

INSTALLING THE OIL PUMP

- Install:
 - Oil pump drive shaft "1"
 - Washer "2"
 - Dowel pin "3"
 - Inner rotor 1 "4"

TIP

- Apply the engine oil on the oil pump drive shaft and inner rotor 1.
- Fit the dowel pin into the groove in the inner rotor 1.

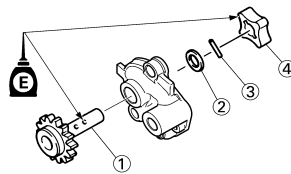

- Install:
 - Outer rotor 1 "1"

TIP

- Apply the engine oil on the outer rotor 1.

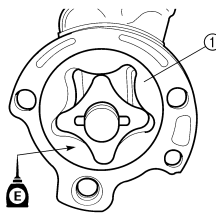

- Install:
 - Oil pump cover "1"
 - Screw (oil pump cover) "2"

Screw (oil pump cover):
2 Nm (0.2 m•kg, 1.4 ft•lb)

- Dowel pin "3"
- Inner rotor 2 "4"
- Circlip "5" **New**

TIP

- Apply the engine oil on the oil pump drive shaft end and inner rotor 2.
- Fit the dowel pin into the groove in the inner rotor 2.

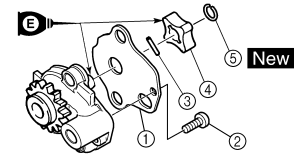

- Install:
 - Outer rotor 2 "1"
 - Dowel pin "2"
 - Oil pump assembly "3"
 - Bolt (oil pump assembly) "4"

Bolt (oil pump assembly):
10 Nm (1.0 m•kg, 7.2 ft•lb)

TIP

- Apply the engine oil on the outer rotor 2.

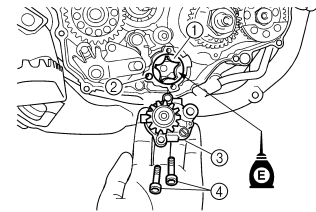

- Install:
 - Oil pump drive gear "1"
 - Washer "2"
 - Circlip "3" **New**

TIP

- Apply the engine oil on the oil pump drive gear inner circumference.

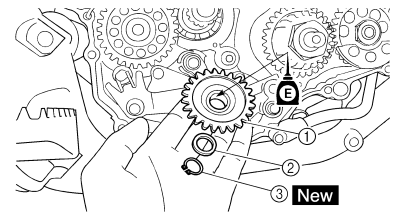

KICK SHAFT AND SHIFT SHAFT

KICK SHAFT AND SHIFT SHAFT

REMOVING THE KICK SHAFT AND SHIFT SHAFT

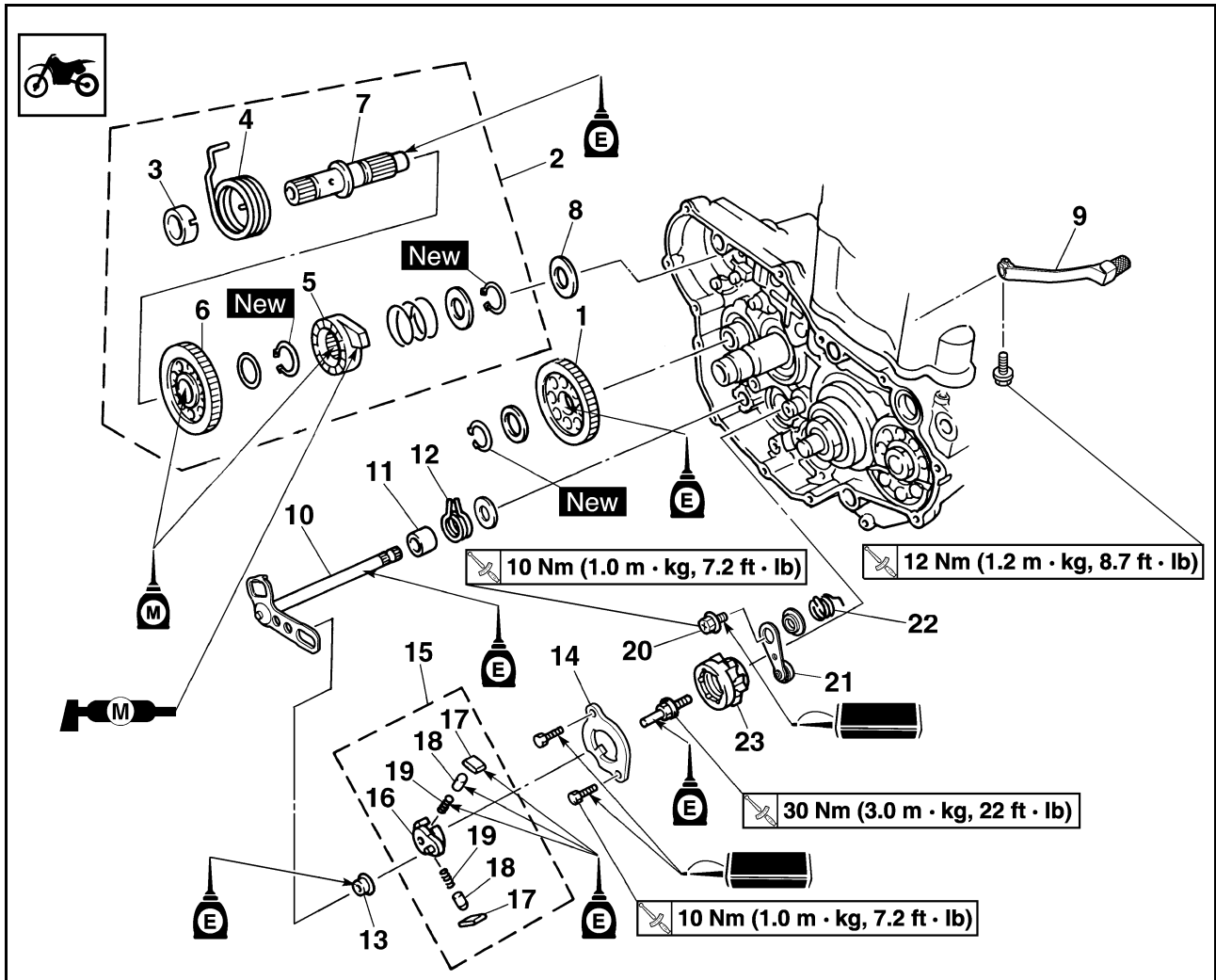

Order	Part name	Q'ty	Remarks
	Oil pump		Refer to "OIL PUMP" section.
1	Kick idle gear	1	
2	Kick shaft assembly	1	Refer to removal section.
3	Spring guide	1	
4	Torsion spring	1	
5	Ratchet wheel	1	
6	Kick gear	1	
7	Kick shaft	1	
8	Washer	1	
9	Shift pedal	1	
10	Shift shaft	1	
11	Collar	1	
12	Torsion spring	1	
13	Roller	1	
14	Shift guide	1	Refer to removal section.
15	Shift lever assembly	1	Refer to removal section.
16	Shift lever	1	

KICK SHAFT AND SHIFT SHAFT

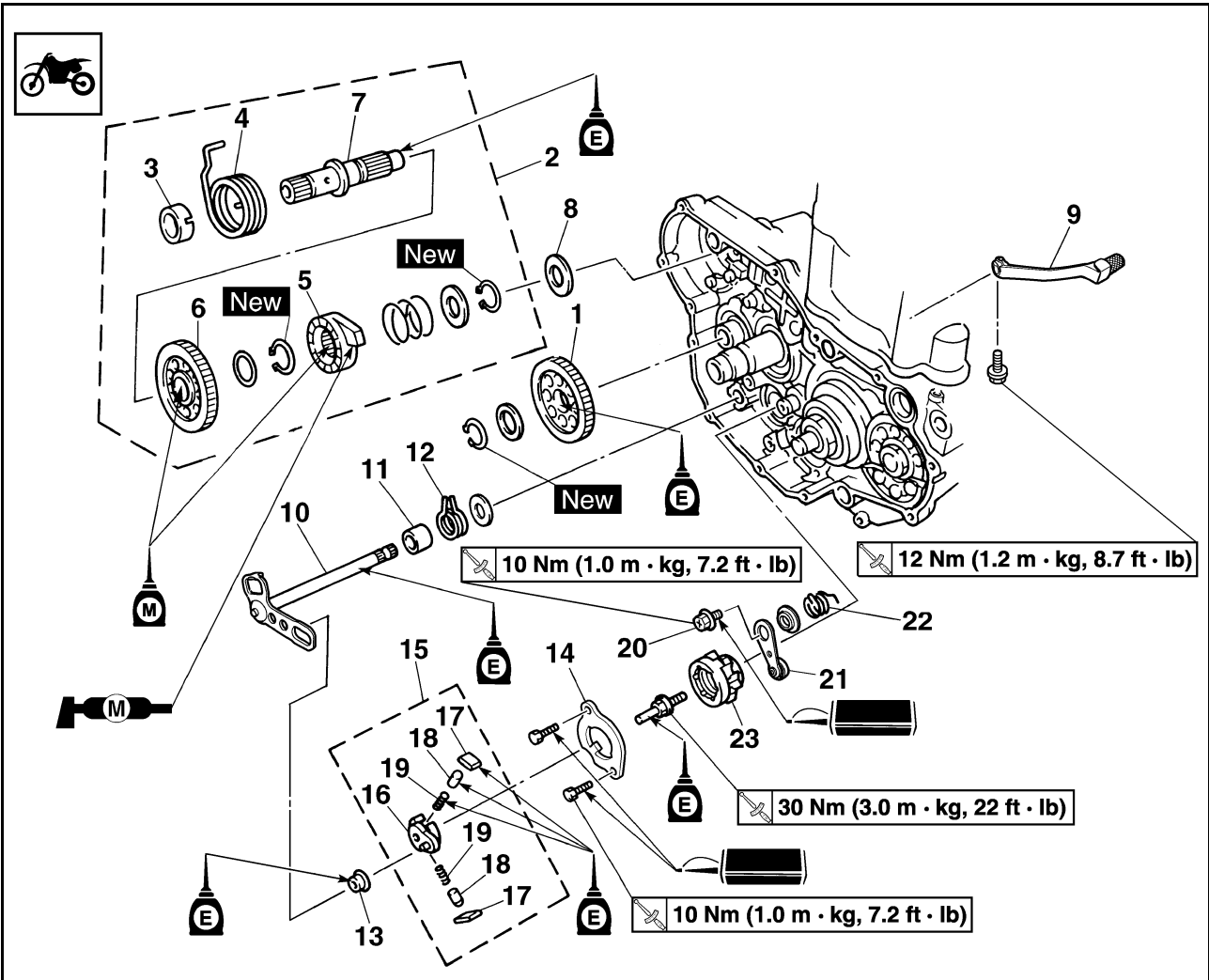

Order	Part name	Q'ty	Remarks
17	Pawl	2	
18	Pawl pin	2	
19	Spring	2	
20	Bolt (stopper lever)	1	
21	Stopper lever	1	
22	Torsion spring	1	
23	Segment	1	Refer to removal section.

KICK SHAFT AND SHIFT SHAFT

REMOVING THE KICK SHAFT ASSEMBLY

- Remove:
 - Kick shaft assembly "1"

TIP

Unhook the torsion spring "2" from the hole "a" in the crankcase.

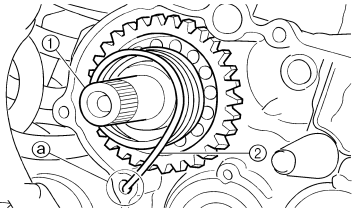

REMOVING THE SHIFT GUIDE AND SHIFT LEVER ASSEMBLY

- Remove:
 - Bolt (shift guide)
 - Shift guide "1"
 - Shift lever assembly "2"

TIP

The shift lever assembly is disassembled at the same time as the shift guide.

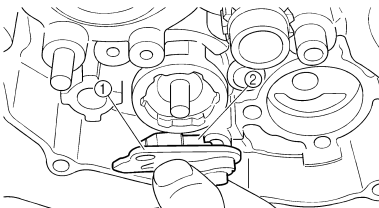

REMOVING THE SEGMENT

- Remove:
 - Bolt (segment) "1"
 - Segment "2"

TIP

Turn the segment counterclockwise until it stops and loosen the bolt.

NOTICE

If the segment gets an impact, it may be damaged. Take care not to give an impact to the segment when removing the bolt.

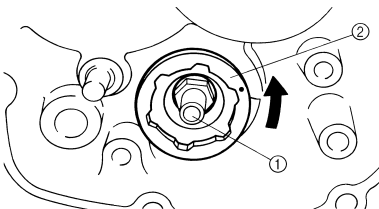

CHECKING THE KICK SHAFT AND RATCHET WHEEL

- Check:
 - Ratchet wheel "1" smooth movement
Unsmooth movement → Replace.
 - Kick shaft "2"
Wear/damage → Replace.
 - Spring "3"
Broken → Replace.

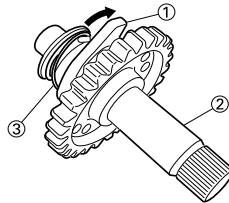

CHECKING THE KICK GEAR, KICK IDLE GEAR AND RATCHET WHEEL

- Inspect:
 - Kick gear "1"
 - Kick idle gear "2"
 - Ratchet wheel "3"
 - Gear teeth "a"
 - Ratchet teeth "b"
 - Wear/damage → Replace.

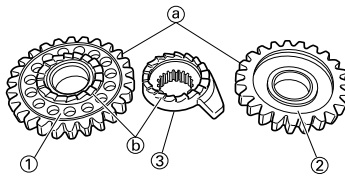

CHECKING THE SHIFT SHAFT

- Inspect:
 - Shift shaft "1"
Bend/damage → Replace.
 - Spring "2"
Broken → Replace.

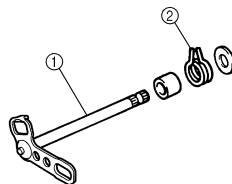

CHECKING THE SHIFT GUIDE AND SHIFT LEVER ASSEMBLY

- Inspect:
 - Shift guide "1"
 - Shift lever "2"
 - Pawl "3"
 - Pawl pin "4"
 - Spring "5"
Wear/damage → Replace.

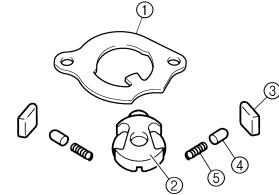

CHECKING THE STOPPER LEVER

- Inspect:
 - Stopper lever "1"
Wear/damage → Replace.
 - Torsion spring "2"
Broken → Replace.

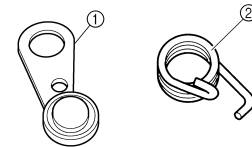

INSTALLING THE SEGMENT

- Install:
 - Segment "1"
 - Bolt (segment)

	Bolt (segment):
	30 Nm (3.0 m•kg, 22 ft•lb)

TIP

Align the notch "a" on the segment with the pin "b" on the shift cam.

NOTICE

If the segment gets an impact, it may be damaged. Take care not to give an impact to the segment when tightening the bolt.

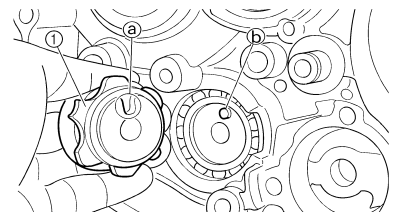

KICK SHAFT AND SHIFT SHAFT

INSTALLING THE STOPPER LEVER

- Install:
 - Torsion spring "1"
 - Washer "2"
 - Stopper lever "3"
 - Bolt (stopper lever) "4" 



Bolt (stopper lever):
10 Nm (1.0 m•kg, 7.2 ft•lb)

TIP

Align the stopper lever roller with the slot on segment.

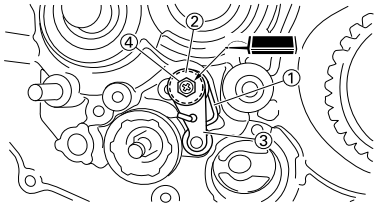

INSTALLING THE SHIFT GUIDE AND SHIFT LEVER ASSEMBLY

- Install:
 - Spring "1"
 - Pawl pin "2"
 - Pawl "3"
 To shift lever "4".

TIP

Apply the engine oil on the spring, pawl pin and pawl.

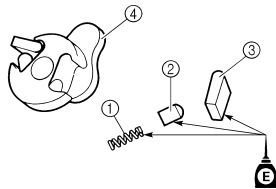

- Install:
 - Shift lever assembly "1"
 To shift guide "2".

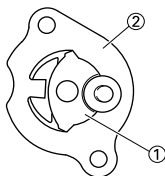

- Install:
 - Shift lever assembly "1"
 - Shift guide "2"

TIP

- The shift lever assembly is installed at the same time as the shift guide.
- Apply the engine oil on the bolt (segment) shaft.

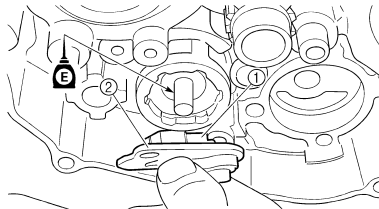

- Install:
 - Bolt (shift guide) "1" 



Bolt (shift guide):
10 Nm (1.0 m•kg, 7.2 ft•lb)

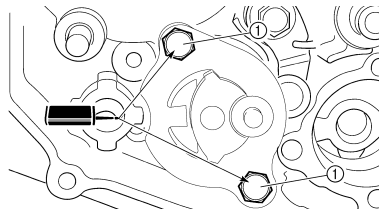

INSTALLING THE SHIFT SHAFT

- Install:
 - Roller "1"
 - Collar "2"
 - Torsion spring "3"
 - Washer "4"
 - Shift shaft "5"

TIP

Apply the engine oil on the roller and shift shaft.

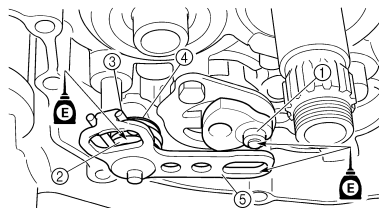

- Install:
 - Shift pedal "1"
 - Bolt (shift pedal) "2"



Bolt (shift pedal):
12 Nm (1.2 m•kg, 8.7 ft•lb)

TIP

Align the punch mark "a" on the shift shaft with the notch "b" in the shift pedal.

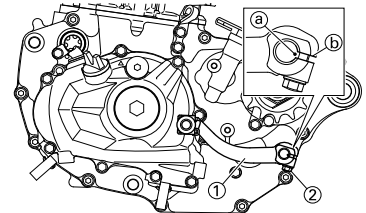

INSTALLING THE KICK SHAFT ASSEMBLY

- Install:
 - Kick gear "1"
 - Washer "2"
 - Circlip "3" **New**
 - Ratchet wheel "4"
 - Spring "5"
 - Washer "6"
 - Circlip "7" **New**
 To kick shaft "8".

TIP

- Apply the molybdenum disulfide oil on the inner circumferences of the kick gear and ratchet wheel.
- Align the punch mark "a" on the ratchet wheel with the punch mark "b" on the kick shaft.

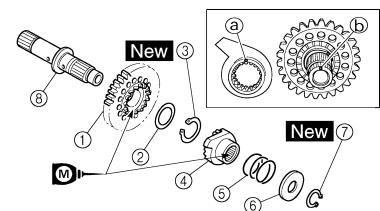

- Install:
 - Torsion spring "1"
 To kick shaft "2".

TIP

Make sure the stopper "a" of the torsion spring fits into the hole "b" on the kick shaft.

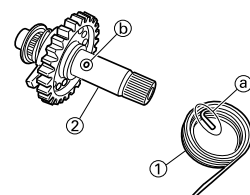

KICK SHAFT AND SHIFT SHAFT

3. Install:

- Spring guide "1"

TIP

Slide the spring guide into the kick shaft, make sure the groove "a" in the spring guide fits on the stopper of the torsion spring.

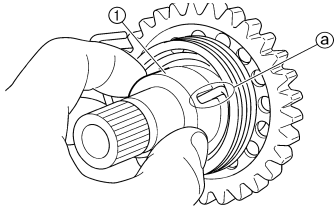

4. Install:

- Kick shaft assembly "1"
- Washer "2"

TIP

- Apply the molybdenum disulfide grease on the contacting surfaces of the kick shaft stopper "a" and kick shaft ratchet wheel guide "3".
- Apply the engine oil on the kick shaft.
- Slide the kick shaft assembly into the crankcase and make sure the kick shaft stopper "a" fits into the kick shaft ratchet wheel guide.

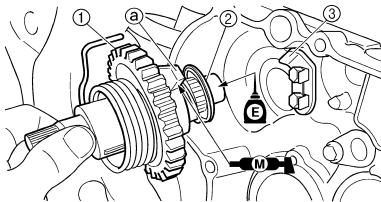

5. Hook:

- Torsion spring "1"

TIP

Turn the torsion spring clockwise and hook into the proper hole "a" in the crankcase.

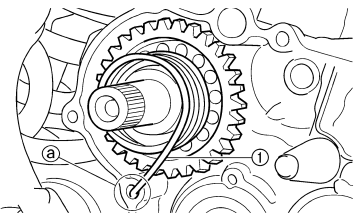

INSTALLING THE KICK IDLE

GEAR

1. Install:

- Kick idle gear "1"
- Washer "2"
- Circlip "3" **New**

TIP

- Apply the engine oil on the kick idle gear inner circumference.
- Install the kick idle gear with its depressed side "a" toward you.

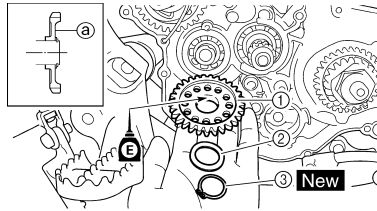

AC MAGNETO

REMOVING THE AC MAGNETO

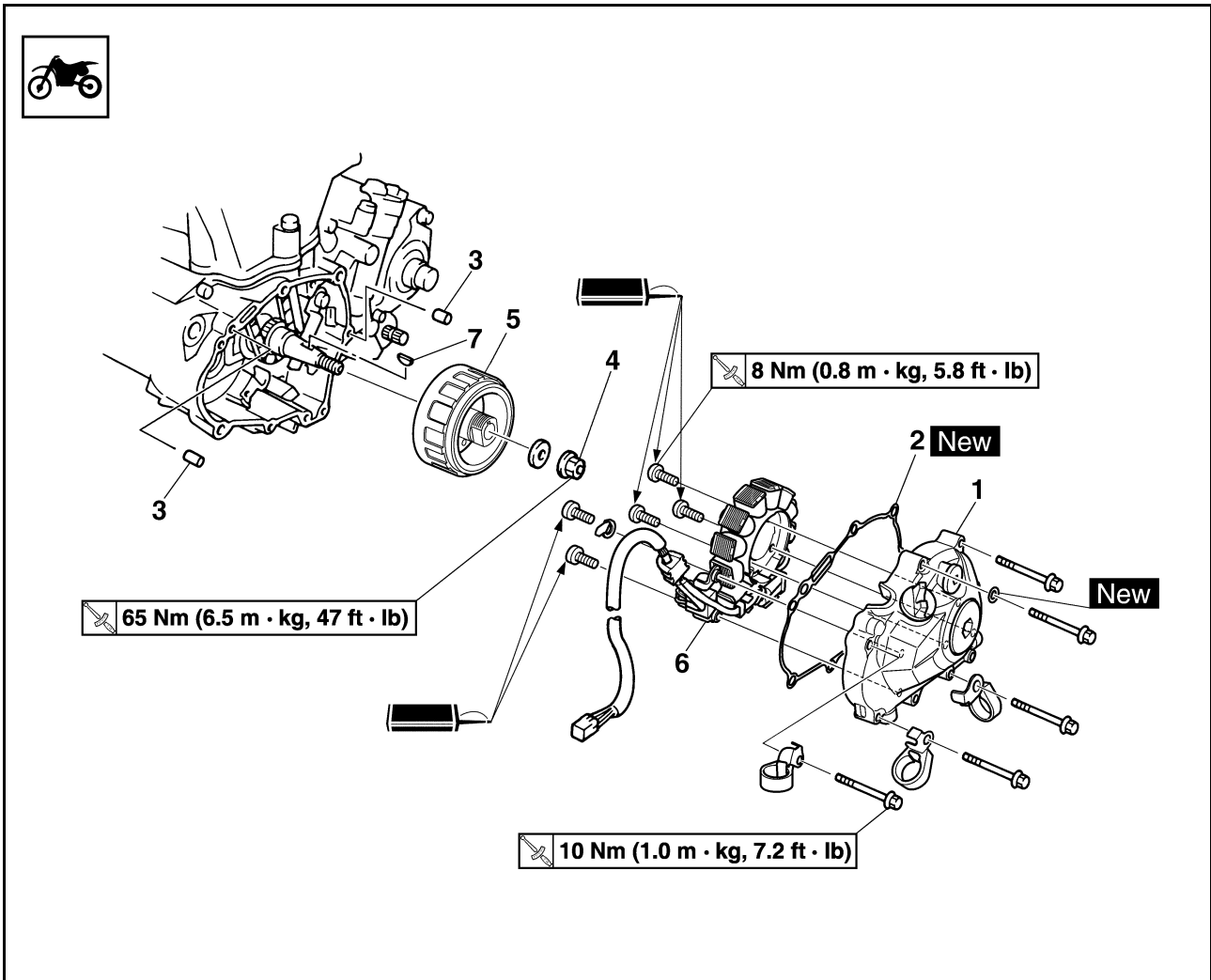

Order	Part name	Q'ty	Remarks
	Seat		Refer to "SEAT AND SIDE COVERS" section.
	Fuel tank		Refer to "FUEL TANK" section in the CHAPTER 6.
	Disconnect the AC magneto lead		
1	Left crankcase cover	1	
2	Gasket	1	
3	Dowel pin	2	
4	Nut (rotor)	1	Refer to removal section.
5	Rotor	1	Refer to removal section.
6	Stator	1	
7	Woodruff key	1	

REMOVING THE ROTOR

- Remove:
 - Nut (rotor) "1"
 - Washer

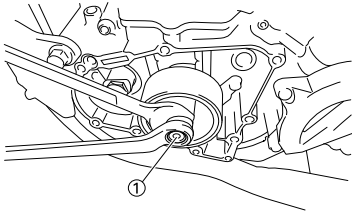

- Remove:
 - Rotor "1"
 Use the rotor puller 2.

	Rotor puller: YM-04151/90890-04151
---	--

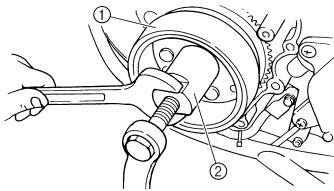

CHECKING THE AC MAGNETO

- Inspect:
 - Rotor inner surface "a"
 - Stator outer surface "b"
 Damage → Inspect the crankshaft runout and crankshaft bearing.

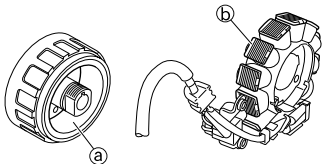

CHECKING THE WOODRUFF KEY

- Inspect:
 - Woodruff key "1"
 Damage → Replace.

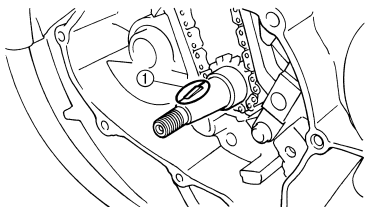

INSTALLING THE AC MAGNETO

- Install:
 - Stator "1"
 - Screw (stator) "2"

	Screw (stator): 8 Nm (0.8 m•kg, 5.8ft•lb)
---	---

- Crankshaft position sensor "3"
- Holder "4"
- Bolt (crankshaft position sensor) "5"

	Bolt (crankshaft position sensor): 10 Nm (1.0 m•kg, 7.2 ft•lb)
---	--

- TIP**
- Apply the sealant on the grommet of the AC magneto lead.
 - Tighten the screws using the T30 bit.
 - Pass the crankshaft position sensor lead "a" this side of the stator lead "b".
 - Install the holder so that the projection "c" on the holder contacts the stopper.

	YAMAHA Bond No. 1215 (ThreeBond® No. 1215): 90890-85505
---	---

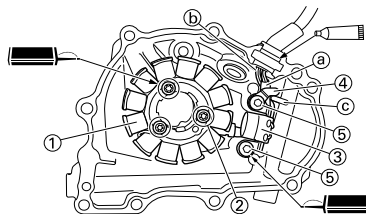

- Install:
 - Woodruff key "1"
 - Rotor "2"

- TIP**
- Degrease the contact surfaces of the tapered portions of the crankshaft and rotor.
 - When installing the woodruff key, make sure that its flat surface "a" is in parallel with the crankshaft center line "b".
 - When installing the rotor, align the keyway "c" of the rotor with the woodruff key.

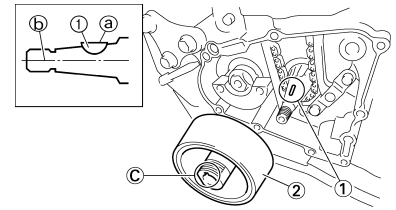

- Install:
 - Washer
 - Nut (rotor) "1"

	Nut (rotor): 65 Nm (6.5 m•kg, 47 ft•lb)
---	---

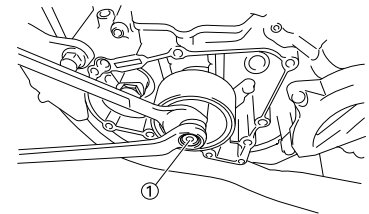

- Connect:
 - AC magneto lead
 Refer to "CABLE ROUTING DIAGRAM" section in the CHAPTER 2.

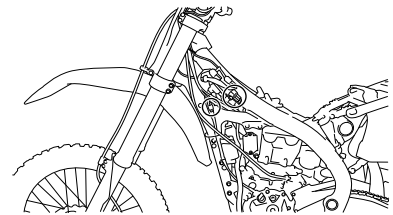

- Install:
 - Dowel pin
 - Gasket (left crankcase cover)**New**
 - Left crankcase cover "1"
 - Hose guide (cylinder head breather hose) "2"
 - Bolt (left crankcase cover)

	Bolt (left crankcase cover): 10 Nm (1.0 m•kg, 7.2 ft•lb)
---	--

- TIP**
- Tighten the bolts in stage, using a crisscross pattern.

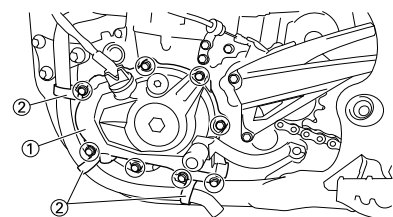

ENGINE REMOVAL

ENGINE REMOVAL

REMOVING THE ELECTRONIC PARTS

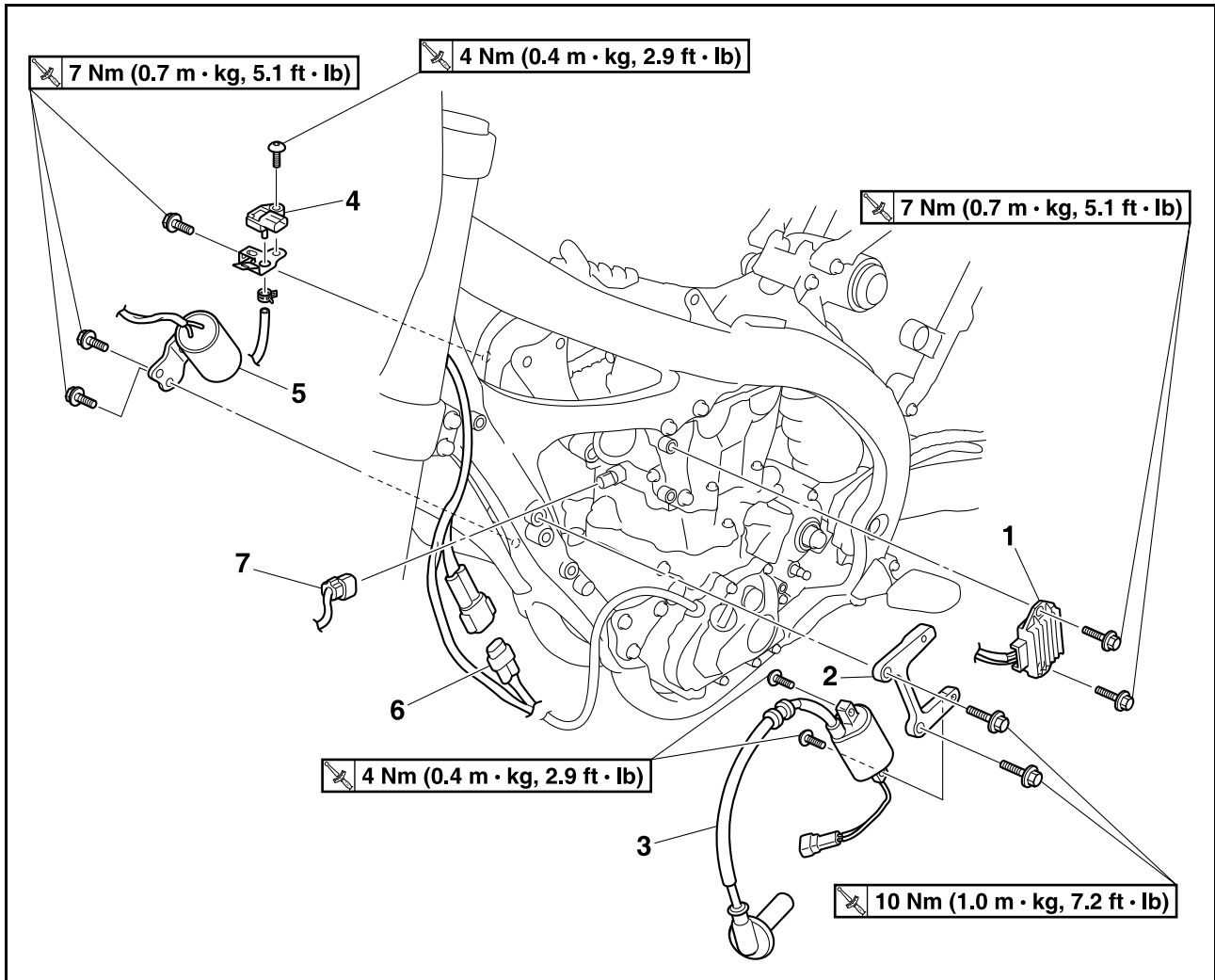

Order	Part name	Q'ty	Remarks
	Hold the machine by placing the suitable stand under the frame.		Refer to "HANDLING NOTE".
	Seat		Refer to "SEAT AND SIDE COVERS" section.
	Fuel tank		Refer to "FUEL TANK" section in the CHAPTER 6.
	Air filter case		Refer to "THROTTLE BODY" section in the CHAPTER 6.
	Radiator		Refer to "RADIATOR" section.
1	Rectifier/regulator	1	
2	Ignition coil bracket	1	
3	Ignition coil	1	
4	Atmospheric pressure sensor	1	
5	Condenser	1	
6	AC magneto lead	1	Disconnect.
7	Coolant temperature sensor coupler	1	Disconnect.

ENGINE REMOVAL

REMOVING THE ENGINE

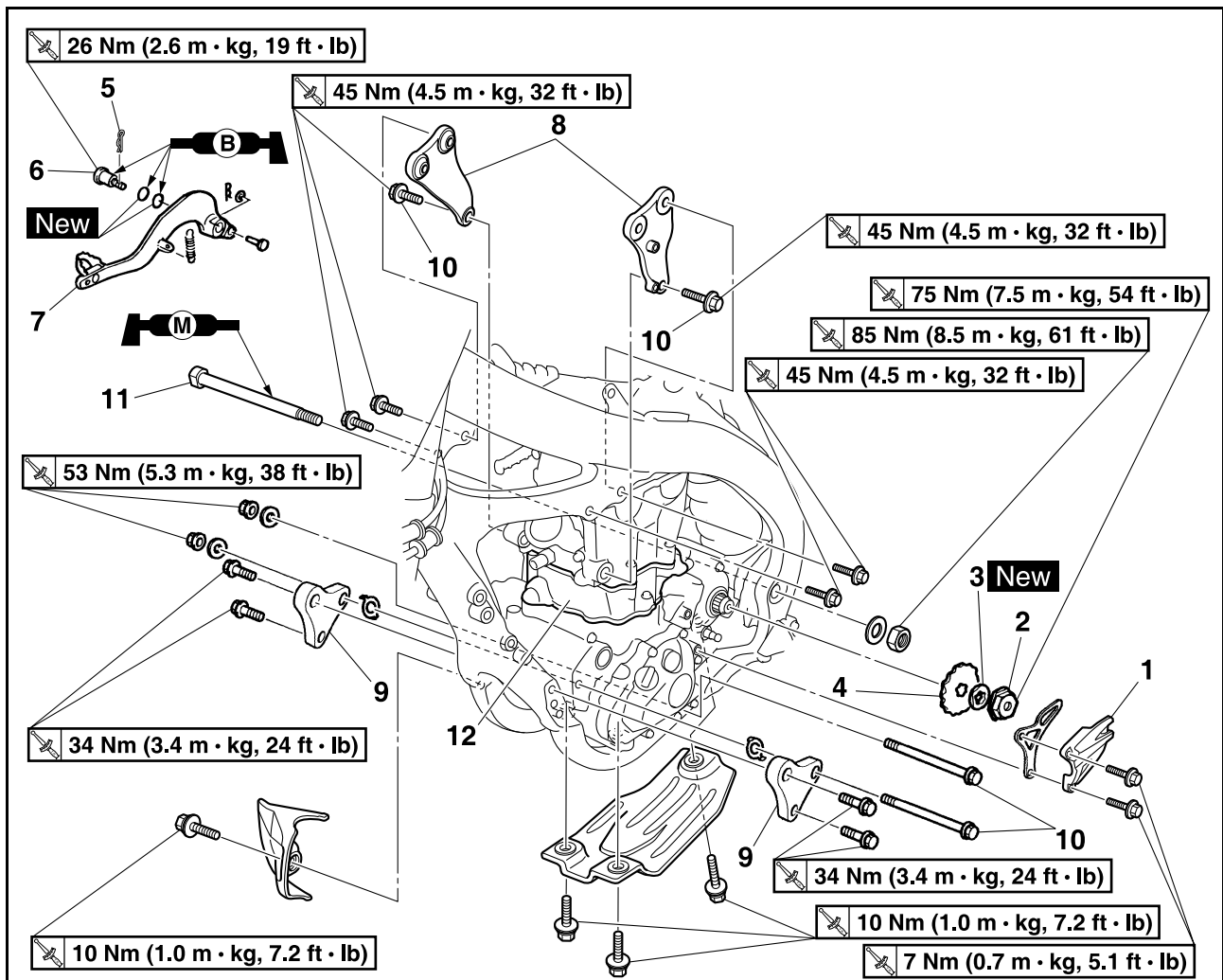

Order	Part name	Q'ty	Remarks
	Hold the machine by placing the suitable stand under the frame.		Refer to "HANDLING NOTE".
	Throttle body		Refer to "THROTTLE BODY" section in the CHAPRE 6.
	Rear fender		Refer to "SEAT AND SIDE COVERS" section.
	Exhaust pipe and silencer		Refer to "EXHAUST PIPE AND SILENCER" section.
	Clutch cable		Disconnect at the engine side.
	Shift pedal		Refer to "KICK SHAFT AND SHIFT SHAFT" section.
	Cylinder head breather hose		Refer to "CAMSHAFTS" section.
	Drain the engine oil.		Refer to "CHANGING THE ENGINE OIL" section in the CHAPTER 3.
	Engine guard (Right)		
1	Drive chain sprocket cover	1	
2	Nut (drive sprocket)	1	Refer to removal section.
3	Lock washer	1	Refer to removal section.
4	Drive sprocket	1	Refer to removal section.

ENGINE REMOVAL

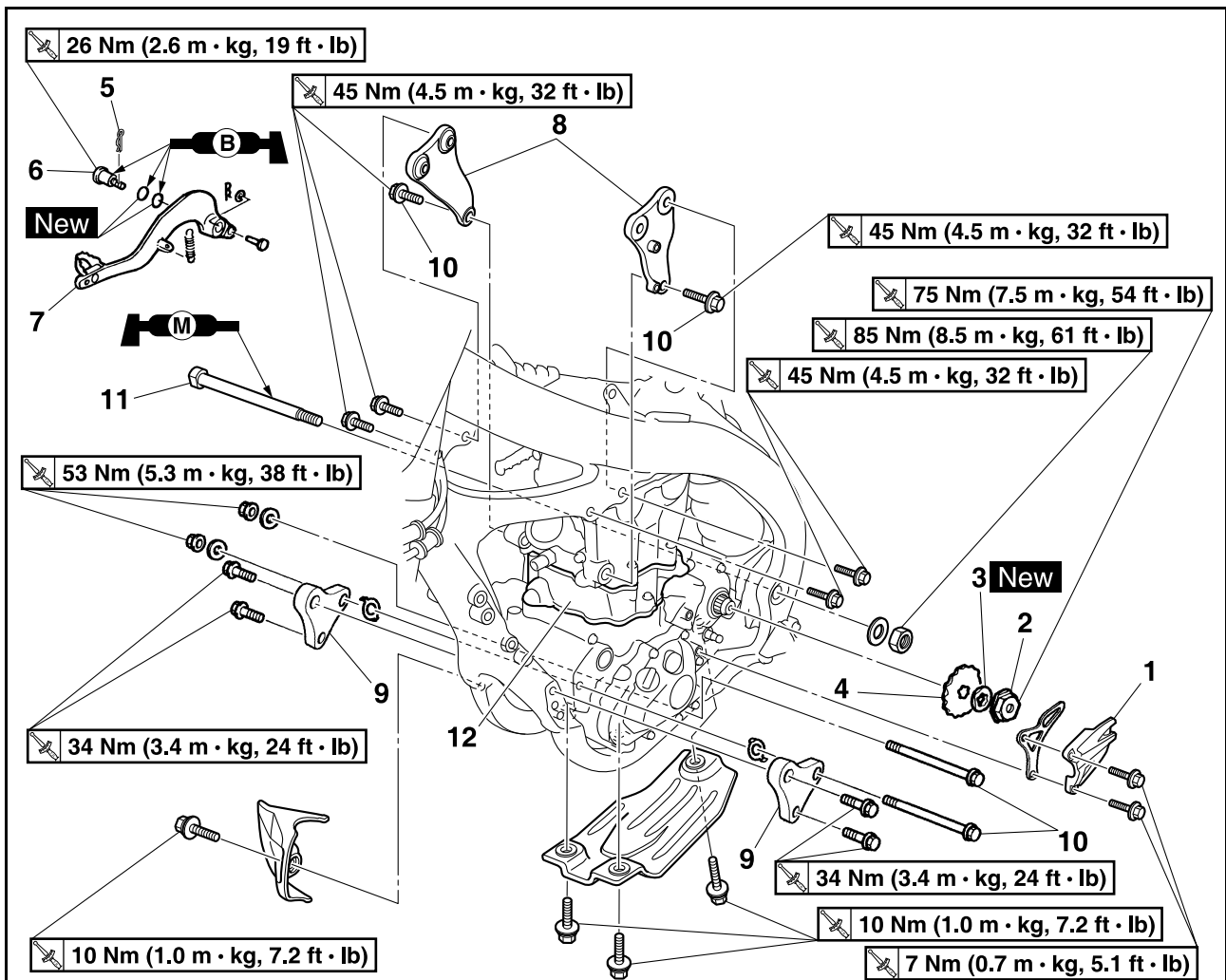

Order	Part name	Q'ty	Remarks
5	Clip	1	
6	Bolt (brake pedal)	1	
7	Brake pedal	1	
8	Upper engine bracket	2	
9	Lower engine bracket	2	
10	Engine mounting bolt	4	
11	Pivot shaft	1	Refer to removal section.
12	Engine	1	Refer to removal section.

ENGINE REMOVAL

HANDLING NOTE

⚠ WARNING

Support the machine securely so there is no danger of it falling over.

REMOVING THE DRIVE SPROCKET

- Remove:
 - Nut (drive sprocket) "1"
 - Lock washer "2"

TIP

- Straighten the lock washer tab.
- Loosen the nut while applying the rear brake.

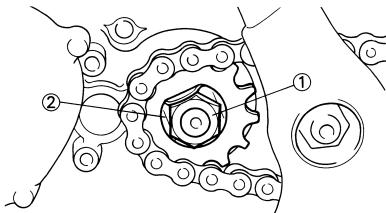

- Remove:
 - Drive sprocket "1"
 - Drive chain "2"

TIP

Remove the drive sprocket together with the drive chain.

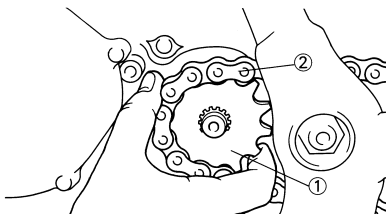

REMOVING THE ENGINE

- Remove:
 - Pivot shaft "1"

TIP

If the pivot shaft is pulled all the way out, the swingarm will come loose. If possible, insert a shaft of similar diameter into the other side of the swingarm to support it.

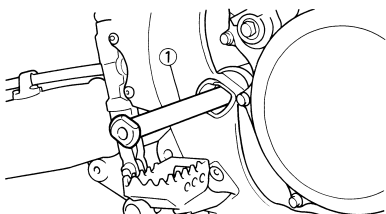

- Remove:
 - Engine "1"

From right side.

TIP

- Make sure that the couplers, hoses and cables are disconnected.
- Turn the engine 90° to the right as shown, and then, while lifting the crankcase in the direction of the arrow shown, remove the engine from the right side of the vehicle.

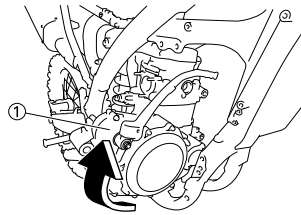

INSTALLING THE ENGINE

- Install:
 - Engine "1"

Install the engine from right side.

 - Pivot shaft "2"

	Pivot shaft: 85 Nm (8.5 m•kg, 61 ft•lb)
--	---

- Engine mounting bolt (lower) "3"

	Engine mounting bolt (lower): 53Nm (5.3 m•kg, 38 ft•lb)
---	---

- Lower engine bracket "4"
- Bolt (lower engine bracket) "5"

	Bolt (lower engine bracket): 34 Nm (3.4 m•kg, 24 ft•lb)
---	---

- Patch "6"
- Engine mounting bolt (front) "7"

	Engine mounting bolt (front): 53 Nm (5.3 m•kg, 38 ft•lb)
---	--

- Upper engine bracket "8"
- Bolt (upper engine bracket) "9"

	Bolt (upper engine bracket): 45 Nm (4.5 m•kg, 32 ft•lb)
---	---

- Engine mounting bolt (upper) "10"

	Engine mounting bolt (upper): 45 Nm (4.5 m•kg, 32 ft•lb)
---	--

TIP

- Apply the molybdenum disulfide grease on the pivot shaft.
- Install the patch with the claw "a" facing outside the chassis.

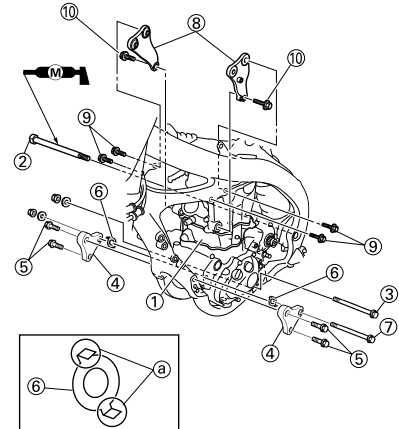

INSTALLING THE BRAKE PEDAL

- Install:
 - Spring "1"
 - Brake pedal "2"
 - O-ring "3" **New**
 - Bolt (brake pedal) "4"

	Bolt (brake pedal): 26 Nm (2.6 m•kg, 19 ft•lb)
---	--

- Clip "5"

TIP

Apply the lithium soap base grease on the bolt, O-rings and brake pedal bracket.

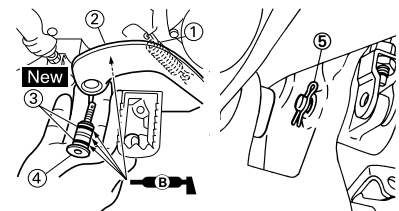

INSTALLING THE DRIVE SPROCKET

- Install:
 - Drive sprocket "1"
 - Drive chain "2"

TIP

Install the drive sprocket together with the drive chain.

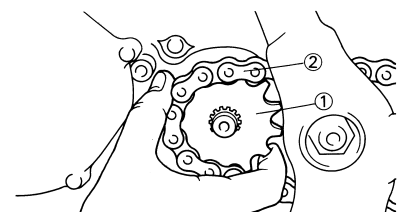

ENGINE REMOVAL

2. Install:

- Lock washer "1" **New**
- Nut (drive sprocket) "2"



Nut (drive sprocket):
75 Nm (7.5 m•kg, 54
ft•lb)

TIP

Tighten the nut while applying the rear brake.

NOTICE

Make sure to tighten to specification; otherwise, it may damage the other part that is fastened together.



3. Bend the lock washer tab to lock the nut.

4. Install:

- Drive chain sprocket guide
- Drive chain sprocket cover "1"
- Bolt (drive chain sprocket cover) "2"



Bolt (drive chain sprocket cover):
7 Nm (0.7 m•kg, 5.1
ft•lb)

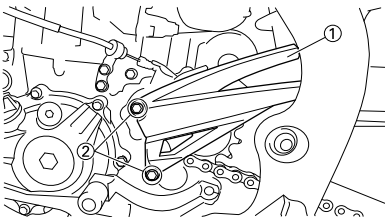

CRANKCASE AND CRANKSHAFT

CRANKCASE AND CRANKSHAFT REMOVING THE CRANKSHAFT

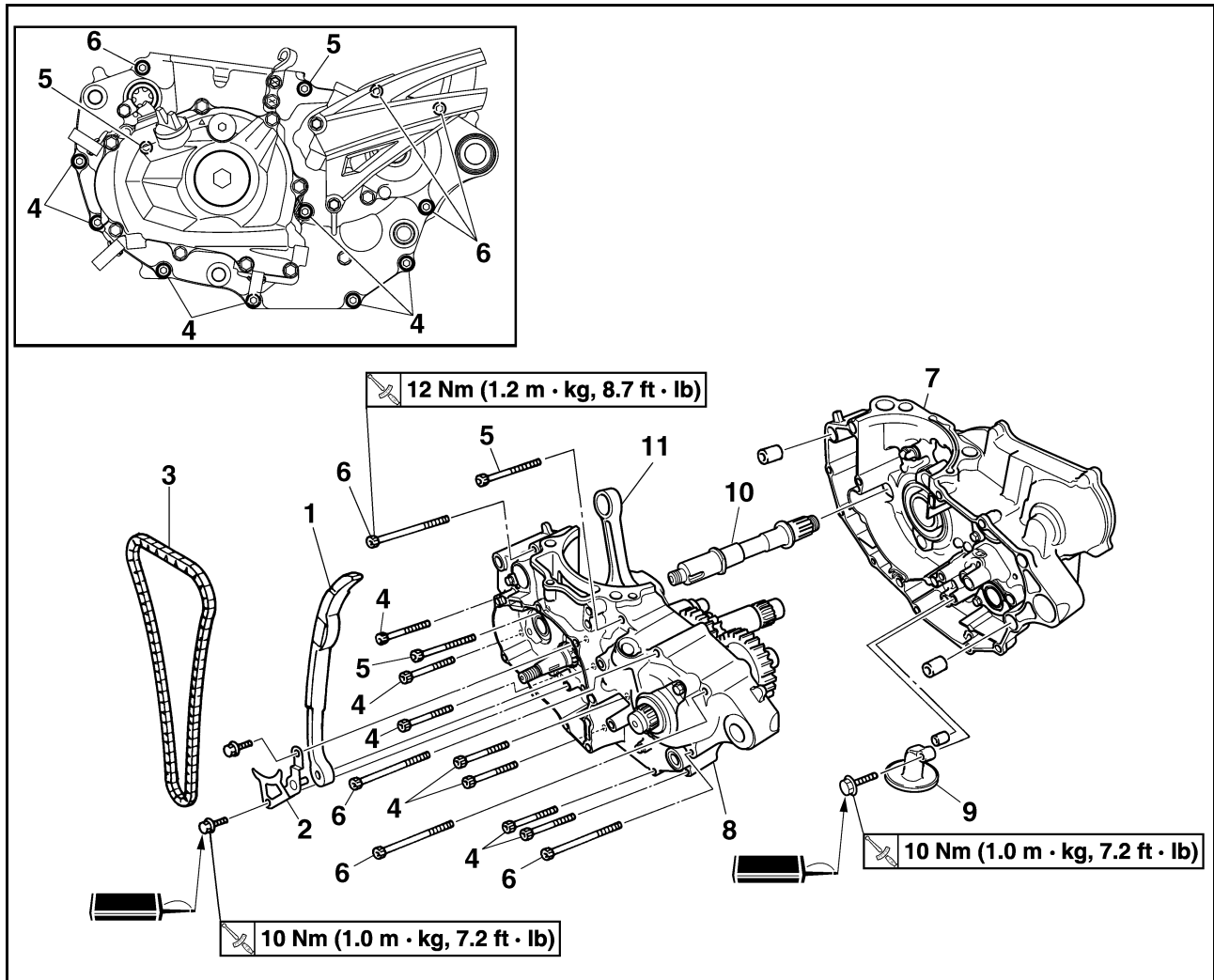

Order	Part name	Q'ty	Remarks
	Engine		Refer to "ENGINE REMOVAL" section.
	Piston		Refer to "CYLINDER AND PISTON" section.
	Balancer		Refer to "BALANCER" section.
	Kick shaft assembly		Refer to "KICK SHAFT AND SHIFT SHAFT" section.
	Segment		Refer to "KICK SHAFT AND SHIFT SHAFT" section.
	Stator		Refer to "AC MAGNETO" section.
1	Timing chain guide (exhaust side)	1	
2	Timing chain guide stopper plate	1	
3	Timing chain	1	
4	Bolt [L = 50 mm (1.97 in)]	7	Refer to removal section.
5	Bolt [L = 60 mm (2.36 in)]	2	Refer to removal section.
6	Bolt [L = 70 mm (2.76 in)]	4	Refer to removal section.
7	Right crankcase	1	Refer to removal section.
8	Left crankcase	1	Refer to removal section.
9	Oil strainer	1	

CRANKCASE AND CRANKSHAFT

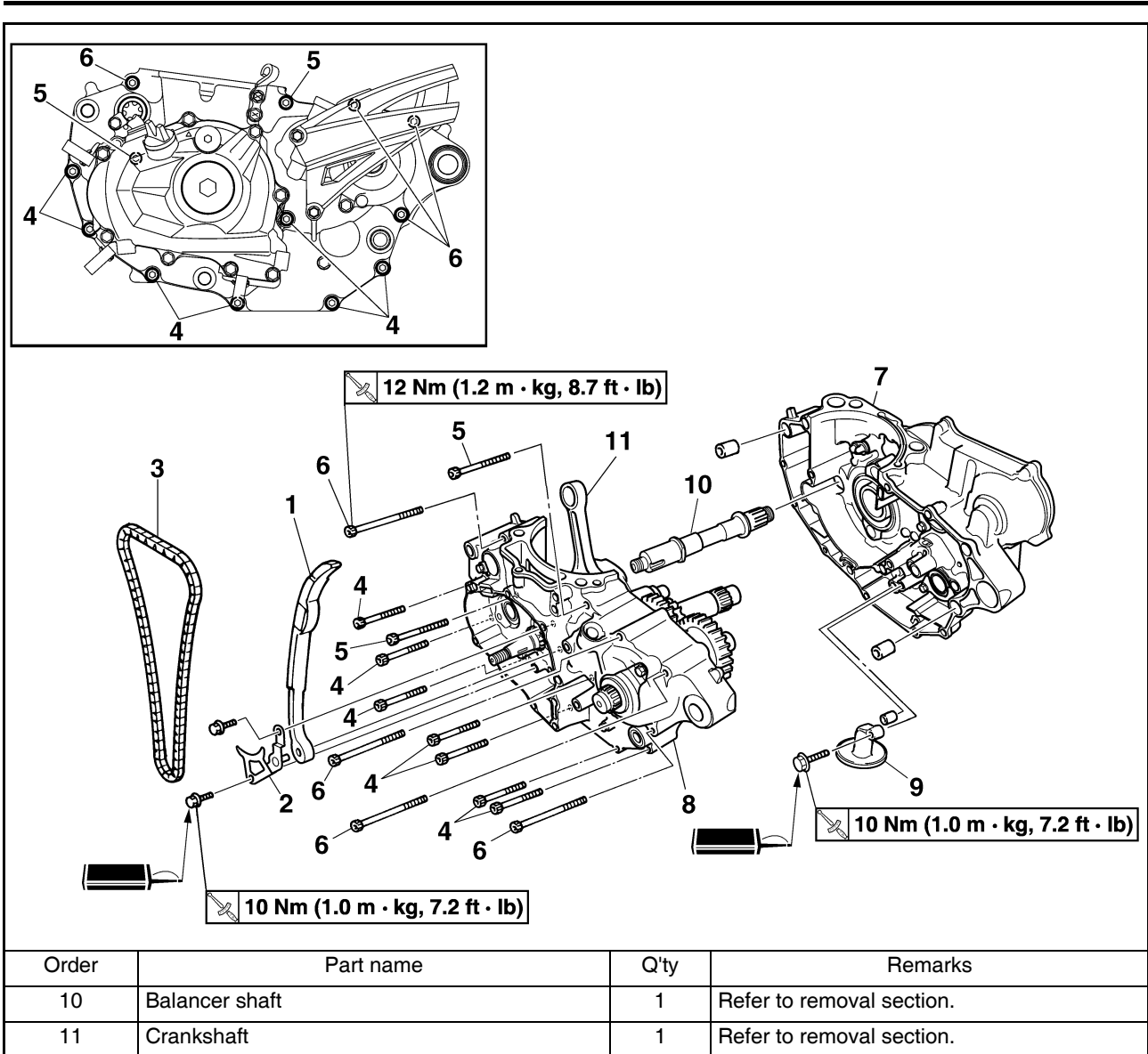

CRANKCASE AND CRANKSHAFT

REMOVING THE CRANKCASE BEARING

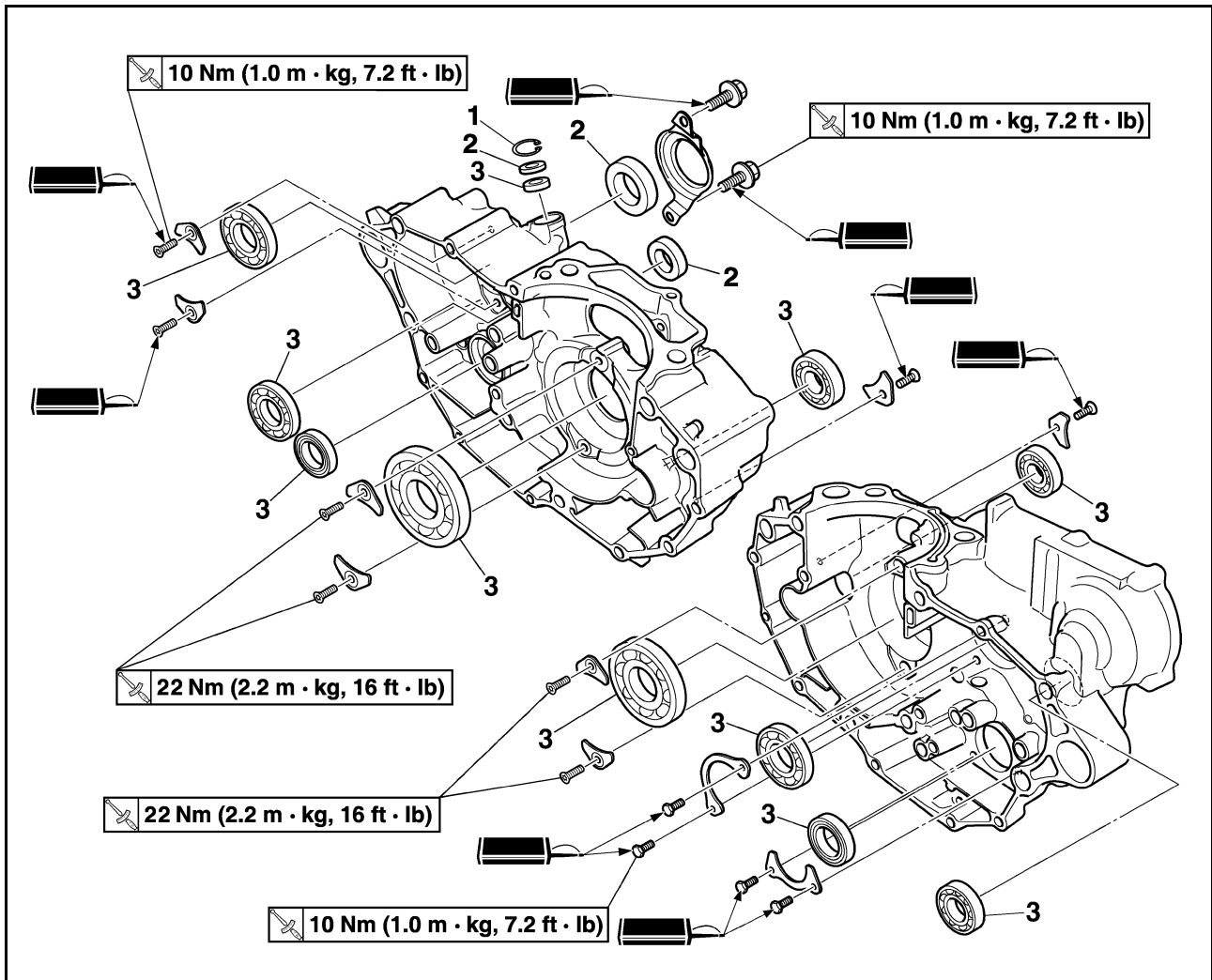

Order	Part name	Q'ty	Remarks
	Transmission		Refer to "TRANSMISSION, SHIFT CAM AND SHIFT FORK" section.
	Shift cam and shift fork		Refer to "TRANSMISSION, SHIFT CAM AND SHIFT FORK" section.
1	Circlip	1	
2	Oil seal	3	
3	Bearing	10	Refer to removal section.

CRANKCASE AND CRANKSHAFT

DISASSEMBLING THE CRANKCASE

- Separate:
 - Right crankcase
 - Left crankcase



Separation steps:

- Remove the crankcase bolts, hose guide and clutch cable holder.

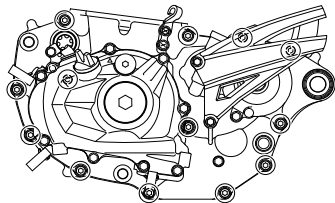

TIP

Loosen each bolt 1/4 of a turn at a time and after all the bolts are loosened, remove them.

- Remove the right crankcase "1".

TIP

- Place the crankcase with its left side downward and split it by inserting a screwdriver tip into the splitting slit "a" in the crankcase.
- Lift the right crankcase horizontally while lightly patting the case splitting slit and engine mounting boss using a soft hammer, and leave the crankshaft and transmission with the left crankcase.

NOTICE

Use soft hammer to tap on the case half. Tap only on reinforced portions of case. Do not tap on gasket mating surface. Work slowly and carefully. Make sure the case halves separate evenly. If the cases do not separate, check for a remaining case bolt or fitting. Do not force.

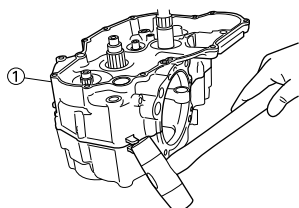
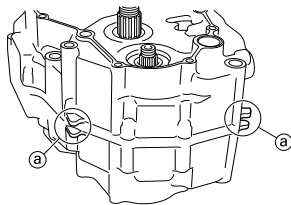

- Remove the dowel pins and O-ring.



REMOVING THE BALANCER SHAFT

- Remove:
 - Balancer shaft "1"

TIP

Remove the balancer shaft with its flat side "a" facing the crankshaft.

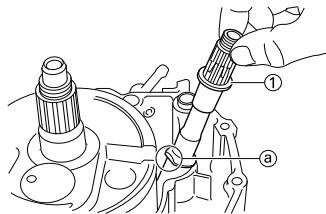

REMOVING THE CRANKSHAFT

- Remove:
 - Crankshaft "1"
 Use the crankcase separating tool "2".

	Crankcase separating tool: YU-A9642/90890-04152
--	---

NOTICE

- Install the crankcase separating tool as shown.
- Do not use a hammer to drive out the crankshaft.

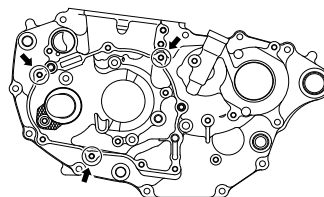
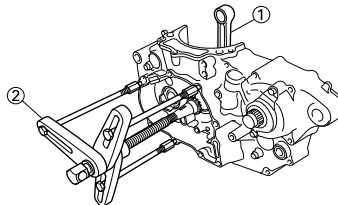

REMOVING THE CRANKCASE BEARING

- Remove:
 - Bearing "1"

TIP

- Remove the bearing from the crankcase by pressing its inner race.
- Do not use the removed bearing.

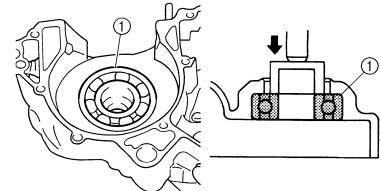

CHECKING THE TIMING CHAIN AND TIMING CHAIN GUIDE

- Inspect:
 - Timing chain
 - Cracks/stiff → Replace the timing chain and camshaft sprocket as a set.

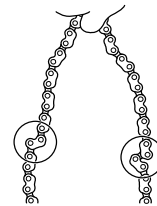

- Inspect:
 - Timing chain guide
 - Wear/damage → Replace.

CHECKING THE CRANKCASE

- Inspect:
 - Contacting surface "a"
 - Scratches → Replace.
 - Engine mounting boss "b", crankcase
 - Cracks/damage → Replace.

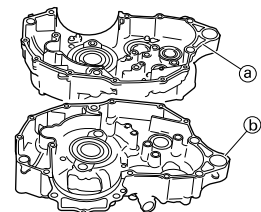

- Inspect:
 - Bearing
 - Rotate inner race with a finger.
 - Rough spot/seizure → Replace.

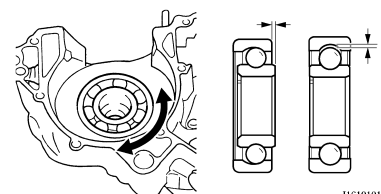

11610101

CRANKCASE AND CRANKSHAFT

3. Inspect:

- Oil seal
Damage → Replace.

CHECKING THE CRANKSHAFT

1. Measure:

- Runout limit "a"
 - Small end free play limit "b"
 - Connecting rod big end side clearance "c"
 - Crank width "d"
- Out of specification → Replace.
Use the dial gauge and a thickness gauge.

Dial gauge and stand: YU-3097/90890-01252		
	Standard	<Limit>
Runout limit:	0.03 mm (0.0012 in)	0.05 mm (0.002 in)
Small end free play:	0.4–1.0 mm (0.016–0.039 in)	2.0 mm (0.08 in)
Side clearance:	0.15–0.45 mm (0.0059–0.0177 in)	0.50 mm (0.02 in)
Crack width:	61.95–62.00 mm (2.439–2.441 in)	—

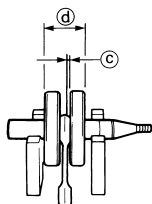
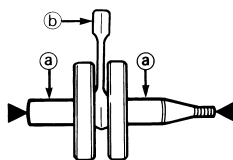

CHECKING THE OIL STRAINER

1. Inspect:

- Oil strainer
Damage → Replace.

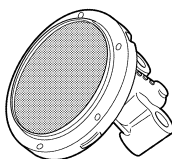

INSTALLING THE CRANKCASE BEARING

1. Install:

- Bearing **New**
- Bearing stopper
- Bolt (bearing stopper) 



- Screw (bearing stopper) 

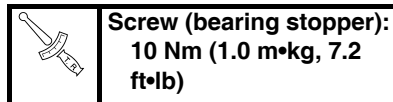

- Screw [bearing stopper (crankshaft)] "1"

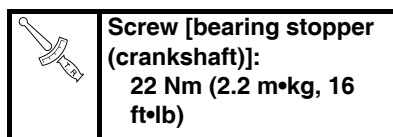

To left and right crankcase.

TIP

- Install the bearing by pressing its outer race parallel.
- To prevent the screw [bearing stopper (crankshaft)] from becoming loose, crush the screw head periphery "a" into the concave "b" using a punch etc. In so doing, take care not to damage the screwdriver receiving hole in the screw head.

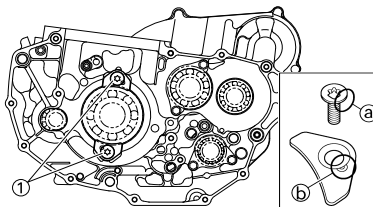

INSTALLING THE CRANKSHAFT

1. Install:

- Crankshaft "1"
- Use the crankshaft installing tool "2", "3", "4" and "5".

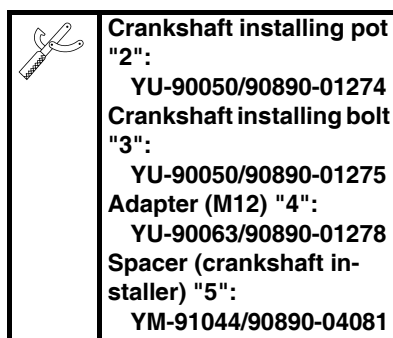

TIP

- Hold the connecting rod at top dead center with one hand while turning the nut of the installing tool with the other. Operate the installing tool until the crankshaft bottoms against the bearing.
- Before installing the crankshaft, clean the contacting surface of crankcase.

NOTICE

- Apply the molybdenum disulfide grease to the crankshaft to prevent it from being scratched.
- Do not use a hammer to drive in the crankshaft.

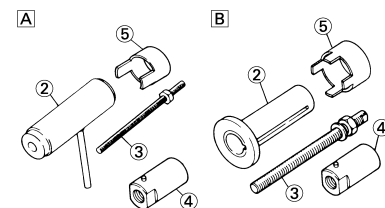
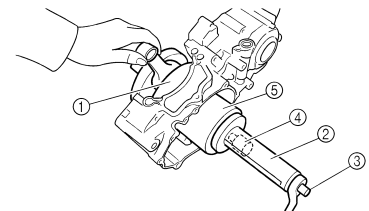

- A. For USA and CDN
- B. Except for USA and CDN

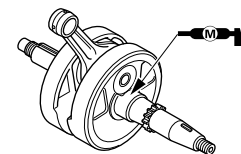

2. Check:

- Shifter operation
- Transmission operation
Unsmooth operation → Repair.

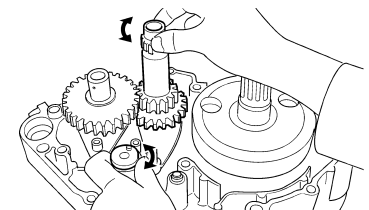

CRANKCASE AND CRANKSHAFT

3. Install:

- Oil strainer "1"
- Bolt (oil strainer) "2"

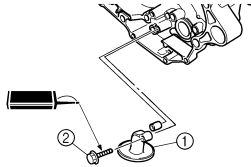
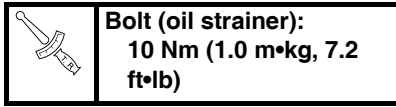

4. Apply:

- Sealant
On the right crankcase.



TIP

Clean the contacting surface of left and right crankcase before applying the sealant.

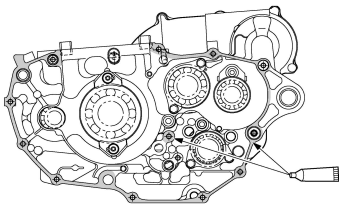

5. Install:

- Dowel pin "1"
- Right crankcase
To left crankcase.

TIP

- Fit the right crankcase onto the left crankcase. Tap lightly on the case with soft hammer.
- When installing the crankcase, the connecting rod should be positioned at TDC (top dead center).

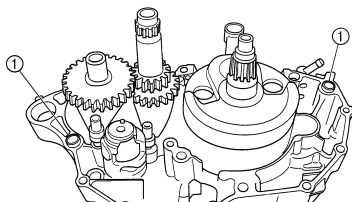

6. Tighten:

- Bolt (crankcase)

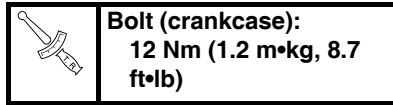

TIP

Tighten the crankcase tightening bolts in stage, using a crisscross pattern.

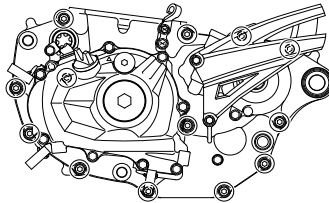

7. Install:

- Timing chain
- Timing chain guide (exhaust side)
- Bolt for timing chain guide (exhaust side))

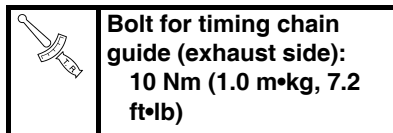

8. Remove:

- Sealant
Forced out on the cylinder mating surface.

9. Apply:

- Engine oil
To the crank pin, bearing and oil delivery hole.

10. Check:

- Crankshaft and transmission operation.
Unsmooth operation → Repair.

TRANSMISSION, SHIFT CAM AND SHIFT FORK

TRANSMISSION, SHIFT CAM AND SHIFT FORK

REMOVING THE TRANSMISSION, SHIFT CAM AND SHIFT FORK

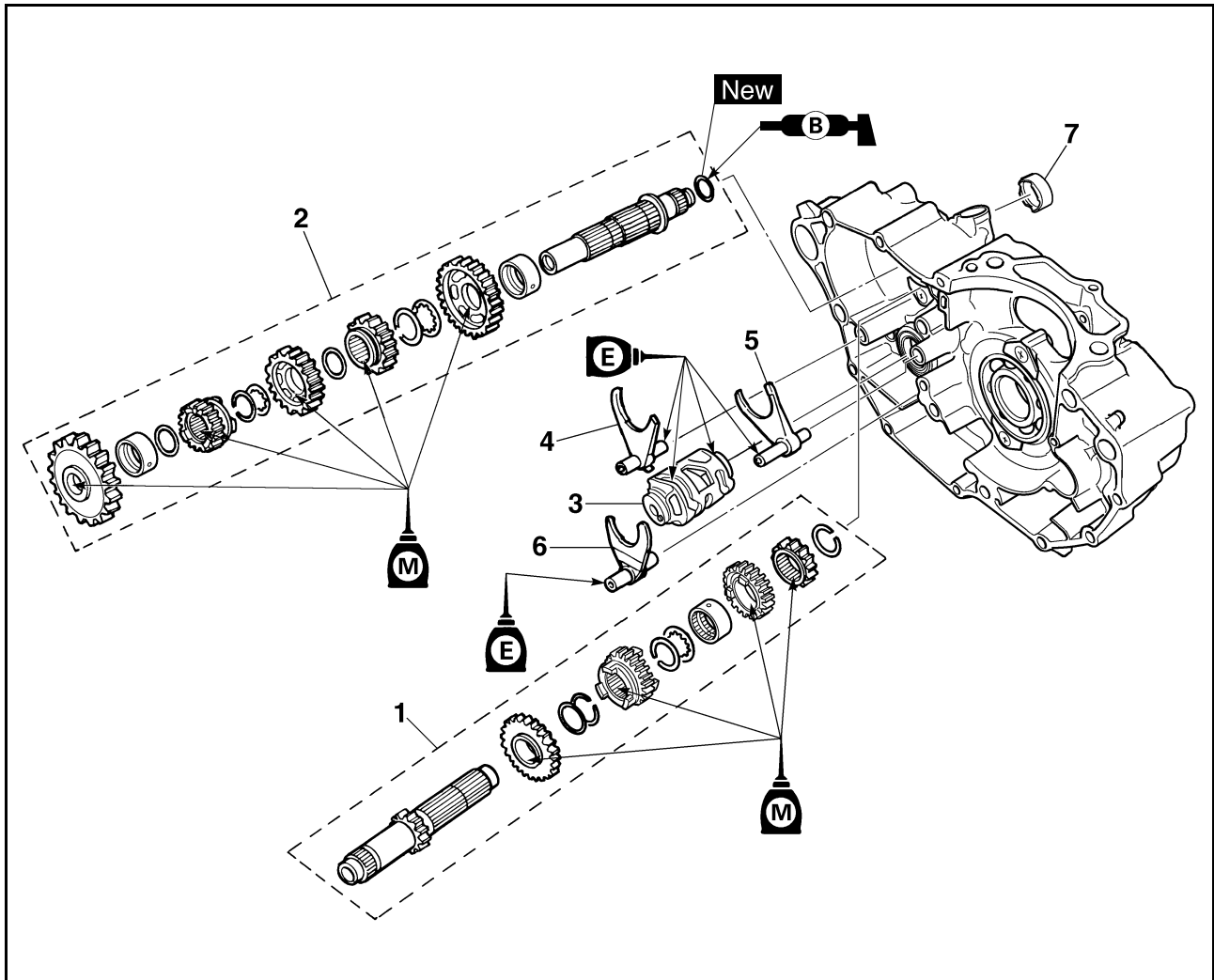

Order	Part name	Q'ty	Remarks
	Engine		Refer to "ENGINE REMOVAL" section.
	Separate the crankcase.		Refer to "CRANKCASE AND CRANK-SHAFT" section.
1	Main axle	1	Refer to removal section.
2	Drive axle	1	Refer to removal section.
3	Shift cam	1	Refer to removal section.
4	Shift fork 3	1	Refer to removal section.
5	Shift fork 2	1	Refer to removal section.
6	Shift fork 1	1	Refer to removal section.
7	Collar	1	

TRANSMISSION, SHIFT CAM AND SHIFT FORK

REMOVING THE TRANSMISSION

- Remove:
 - Main axle "1"
 - Drive axle "2"
 - Shift cam
 - Shift fork 3
 - Shift fork 2
 - Shift fork 1

TIP

- Remove assembly with the collar "3" installed to the crankcase.
- Remove assembly carefully. Note the position of each part. Pay particular attention to the location and direction of shift forks.
- Remove the main axle, drive axle, shift cam and shift fork all together by tapping lightly on the transmission drive axle with a soft hammer.

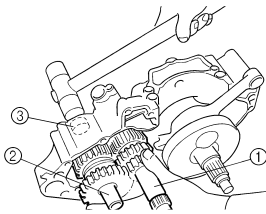

CHECKING THE GEARS

- Inspect:
 - Matching dog "a"
 - Gear teeth "b"
 - Shift fork groove "c"
 Wear/damage → Replace.

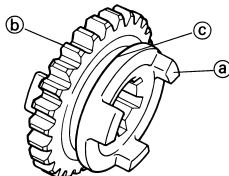

- Inspect:
 - O-ring "1"
 Damage → Replace.

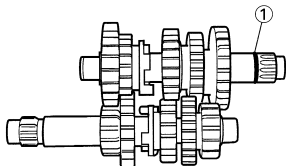

- Check:
 - Gears movement
 Unsmooth movement → Repair or replace.

CHECKING THE BEARING

- Inspect:
 - Bearing "1"
 Rotate inner race with a finger.
 Rough spot/seizure → Replace.

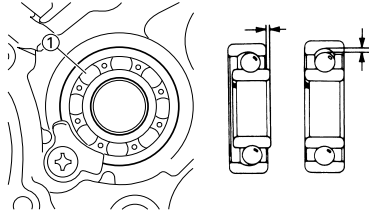

CHECKING THE SHIFT FORK, SHIFT CAM AND SEGMENT

- Inspect:
 - Shift fork "1"
 Wear/damage/scratches → Replace.

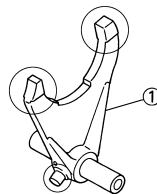

- Inspect:
 - Shift cam "1"
 - Segment "2"
 Wear/damage → Replace.

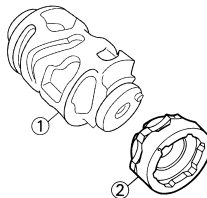

- Check:
 - Shift fork movement
 Unsmooth operation → Replace shift fork.

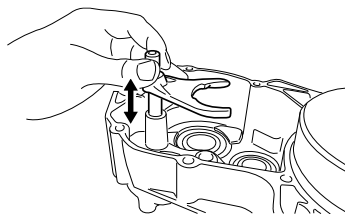

TIP

For a malfunctioning shift fork, replace not only the shift fork itself but the two gears each adjacent to the shift fork.

INSTALLING THE TRANSMISSION

- Install:
 - 5th pinion gear (21T) "1"
 - 3rd pinion gear (18T) "2"
 - Collar "3"
 - 4th pinion gear (22T) "4"
 - 2nd pinion gear (15T) "5"
 To main axle "6".

TIP

Apply the molybdenum disulfide oil on the inner and end surface of the idler gear and on the inner surface of the sliding gear, then install.

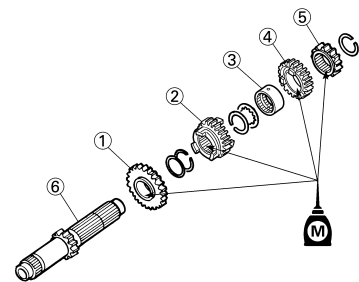

- Install:
 - Collar "1"
 - 2nd wheel gear (23T) "2"
 - 4th wheel gear (24T) "3"
 - 3rd wheel gear (23T) "4"
 - 5th wheel gear (20T) "5"
 - Collar "6"
 - 1st wheel gear (27T) "7"
 - O-ring "8" **New**
 To drive axle "9".

TIP

- Apply the molybdenum disulfide oil on the inner and end surface of the idler gear and on the inner surface of the sliding gear, then install.
- Apply the lithium soap base grease on the O-ring.

TRANSMISSION, SHIFT CAM AND SHIFT FORK

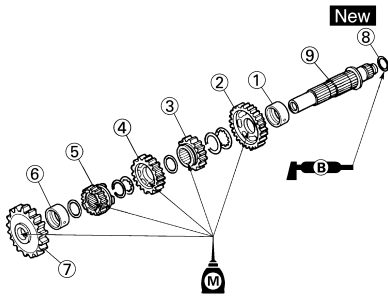

3. Install:

- Washer "1"
- Circlip "2" **New**

TIP

- Be sure the circlip sharp-edged corner "a" is positioned opposite side to the washer and gear "b".
- Install the circlip with its ends "c" settled evenly on the spline crests.

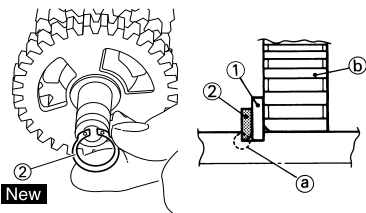

4. Install:

- Collar "1"

TIP

- Apply the lithium soap base grease on the oil seal lip.
- When installing the collar into the crankcase, pay careful attention to the crankcase oil seal lip.

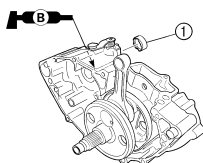

5. Install:

- Shift fork 1 (L) "1"
 - Shift fork 2 (C) "2"
 - Shift fork 3 (R) "3"
 - Shift cam "4"
- To main axle and drive axle.

TIP

- Apply the molybdenum disulfide oil on the shift fork grooves.
- Apply engine oil to the shift cam groove, bearing contact surface and shift fork shaft.
- Mesh the shift fork #1 (L) with the 4th wheel gear "5" and #3 (R) with the 5th wheel gear "7" on the drive axle.
- Mesh the shift fork #2 (C) with the 3rd pinion gear "6" on the main axle.

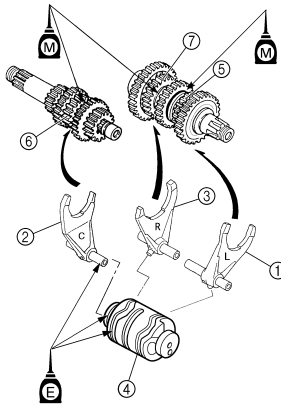

6. Install:

- Transmission assembly "1"
- To left crankcase "2".

TIP

Apply the engine oil on the bearings and guide bars.

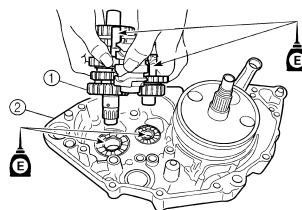

7. Check:

- Shifter operation
 - Transmission operation
- Unsmooth operation → Repair.

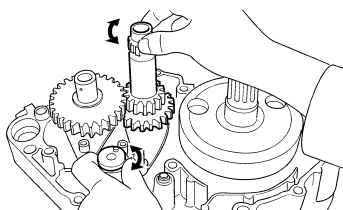

FRONT WHEEL AND REAR WHEEL

CHASSIS

TIP

This section is intended for those who have basic knowledge and skill concerning the servicing of Yamaha motorcycles (e.g., Yamaha dealers, service engineers, etc.) Those who have little knowledge and skill concerning servicing are requested not to undertake inspection, adjustment, disassembly, or reassembly only by reference to this manual. It may lead to servicing trouble and mechanical damage.

FRONT WHEEL AND REAR WHEEL

REMOVING THE FRONT WHEEL

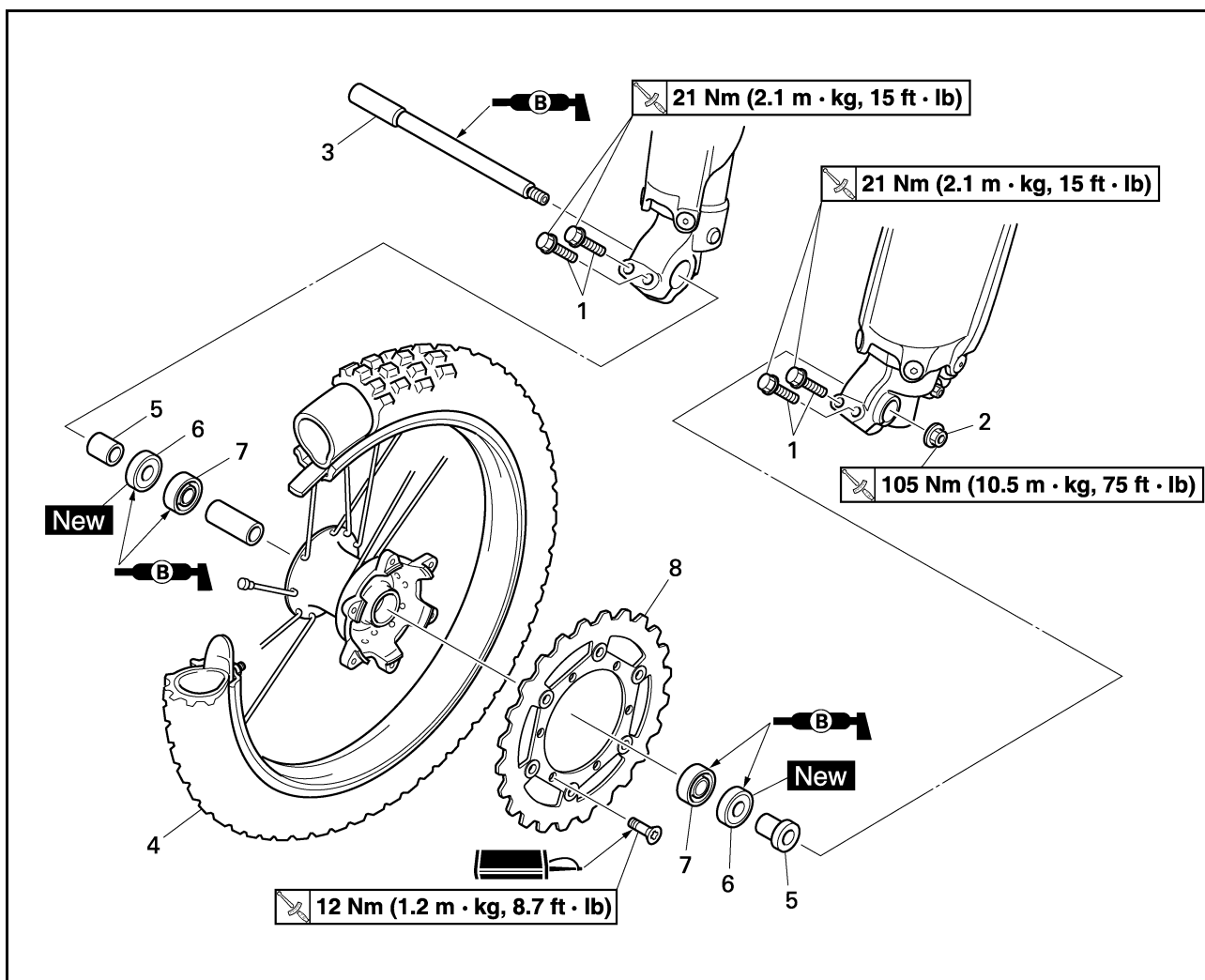

Order	Part name	Q'ty	Remarks
	Hold the machine by placing the suitable stand under the engine.		Refer to "HANDLING NOTE".
1	Bolt (axle holder)	4	Only loosening.
2	Nut (front wheel axle)	1	
3	Front wheel axle	1	
4	Front wheel	1	
5	Collar	2	
6	Oil seal	2	
7	Bearing	2	Refer to removal section.
8	Brake disc	1	

FRONT WHEEL AND REAR WHEEL

REMOVING THE REAR WHEEL

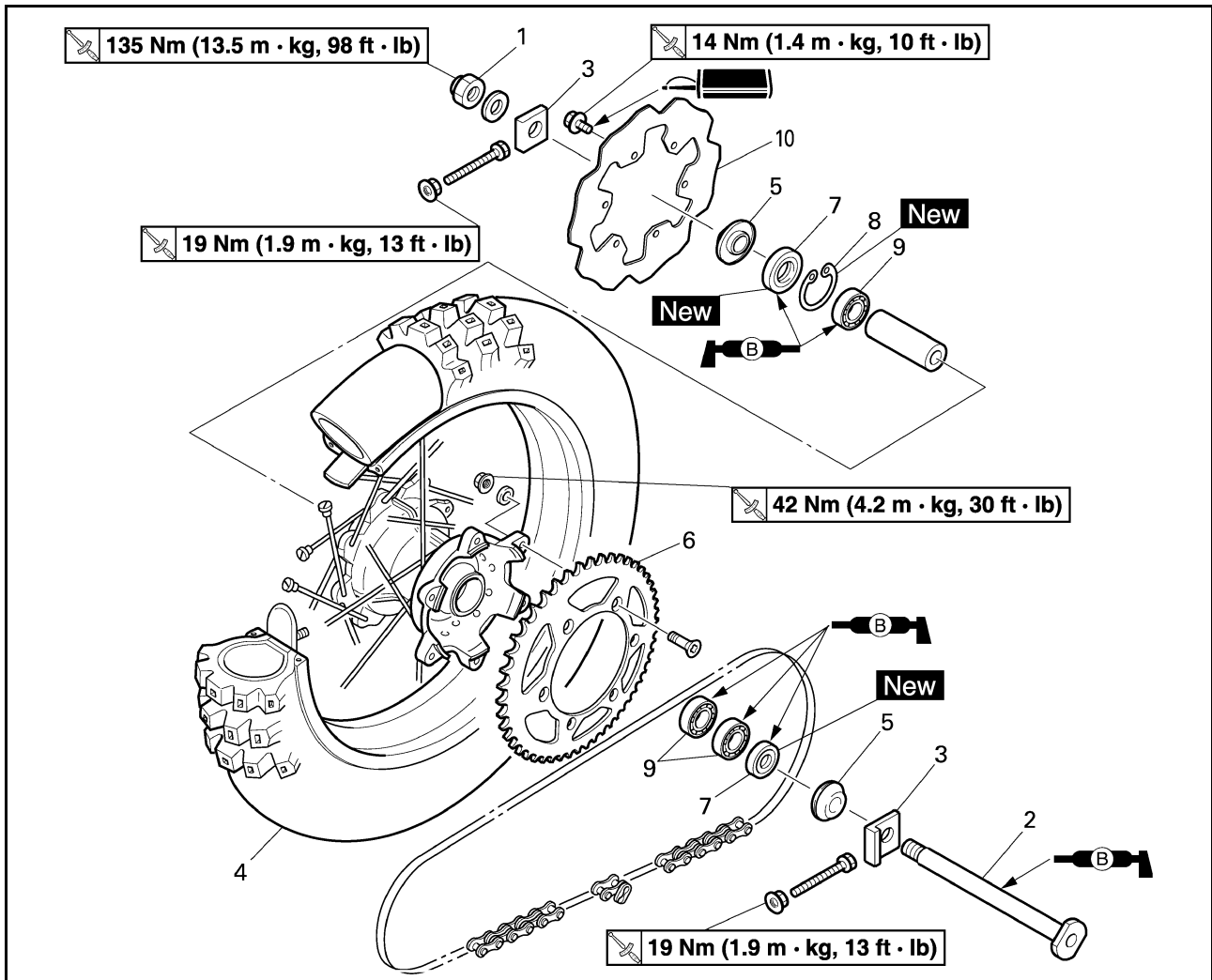

Order	Part name	Q'ty	Remarks
	Hold the machine by placing the suitable stand under the engine.		Refer to "HANDLING NOTE".
1	Nut (rear wheel axle)	1	
2	Rear wheel axle	1	
3	Drive chain puller	2	
4	Rear wheel	1	Refer to removal section.
5	Collar	2	
6	Rear wheel sprocket	1	
7	Oil seal	2	
8	Circlip	1	
9	Bearing	3	Refer to removal section.
10	Brake disc	1	

FRONT WHEEL AND REAR WHEEL

HANDLING NOTE

⚠ WARNING

Support the machine securely so there is no danger of it falling over.

REMOVING THE REAR WHEEL

- Remove:
 - Wheel "1"

TIP

Push the wheel forward and remove the drive chain "2".

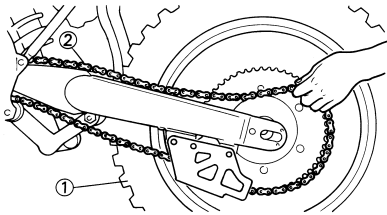

REMOVING THE WHEEL BEARING

- Remove:
 - Bearing "1"

TIP

Remove the bearing using a general bearing puller "2".

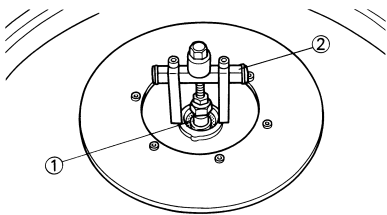

CHECKING THE WHEEL

- Measure:
 - Wheel runout
 - Out of limit → Repair/replace.

	Wheel runout limit:
	Radial "1": 2.0 mm (0.08 in) Lateral "2": 2.0 mm (0.08 in)

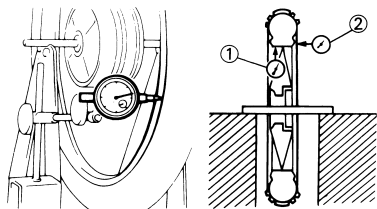

- Inspect:
 - Bearing
 - Rotate inner race with a finger.
 - Rough spot/seizure → Replace.

TIP

Replace the bearings, oil seal and wheel collar as a set.

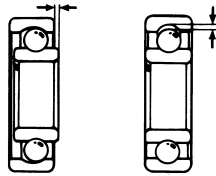

CHECKING THE WHEEL AXLE

- Measure:
 - Wheel axle bends
 - Out of specification → Replace.
 - Use the dial gauge "1".

	Wheel axle bending limit:
	0.5 mm (0.020 in)

TIP

The bending value is shown by one half of the dial gauge reading.

⚠ WARNING

Do not attempt to straighten a bent axle.

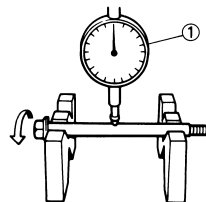

CHECKING THE BRAKE DISC

- Measure:
 - Brake disc deflection (only rear brake disc)
 - Use the dial gauge "1".
 - Out of specification → Inspect wheel runout.
 - If wheel runout is in good condition, replace the brake disc.

	Brake disc deflection limit:
	Rear: <Limit>: 0.15 mm (0.006 in)

- Measure:
 - Brake disc thickness "a"
 - Out of limit → Replace.

	Brake disc thickness:
	Front: 3.0 mm (0.12 in) <Limit>: 2.5 mm (0.10 in) Rear: 4.0 mm (0.16 in) <Limit>: 3.5 mm (0.14 in)

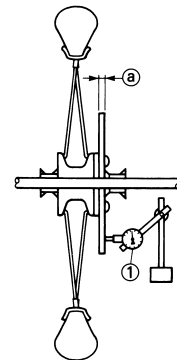

INSTALLING THE FRONT WHEEL

- Install:
 - Bearing (left) "1"
 - Spacer "2"
 - Bearing (right) "3"
 - Oil seal "4" **New**

TIP

- Apply the lithium soap base grease on the bearing and oil seal lip when installing.
- Use a socket that matches the outside diameter of the race of the bearing.
- Left side of bearing shall be installed first.
- Install the oil seal with its manufacturer's marks or numbers facing outward.

NOTICE

Do not strike the inner race of the bearing. Contact should be made only with the outer race.

FRONT WHEEL AND REAR WHEEL

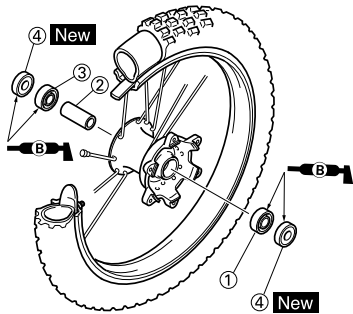

2. Install:

- Brake disc "1"
- Bolt (brake disc) "2"



Bolt (brake disc):
12 Nm (1.2 m•kg, 8.7 ft•lb)

TIP

Tighten the bolts in stage, using a crisscross pattern.

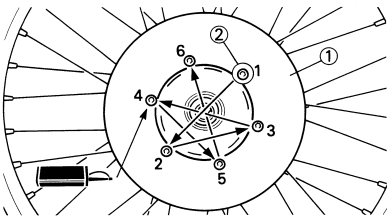

3. Install:

- Collar "1"

TIP

- Apply the lithium soap base grease on the oil seal lip.
- Install the collars with their projections "a" facing the wheel.

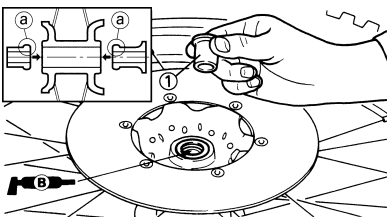

4. Install:

- Wheel

TIP

Install the brake disc "1" between the brake pads "2" correctly.

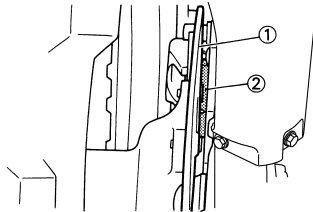

5. Install:

- Wheel axle "1"

TIP

Apply the lithium soap base grease on the wheel axle.

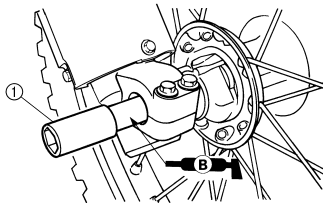

6. Install:

- Nut (wheel axle) "1"



Nut (wheel axle):
105 Nm (10.5 m•kg, 75 ft•lb)

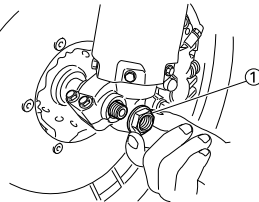

7. Tighten:

- Bolt (axle holder) "1"



Bolt (axle holder):
21 Nm (2.1 m•kg, 15 ft•lb)

TIP

Before tightening the bolt, fit the wheel axle to the axle holder by stroking the front fork several times with the front brake applied.

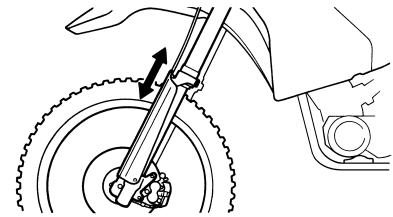
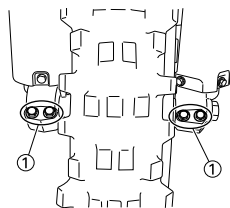

INSTALLING THE REAR WHEEL

1. Install:

- Bearing (right) "1"
- Circlip "2" **New**
- Spacer "3"
- Bearing (left) "4"
- Oil seal "5" **New**

TIP

- Apply the lithium soap base grease on the bearing and oil seal lip when installing.
- Install the bearing with seal facing outward.
- Use a socket that matches the outside diameter of the race of the bearing.
- Right side of bearing shall be installed first.
- Install the oil seal with its manufacturer's marks or numbers facing outward.

NOTICE

Do not strike the inner race of the bearing. Contact should be made only with the outer race.

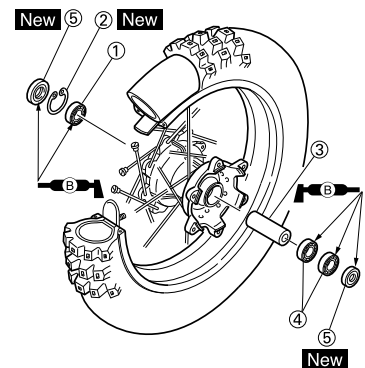

FRONT WHEEL AND REAR WHEEL

2. Install:

- Brake disc "1"
- Bolt (brake disc) "2"



Bolt (brake disc):
14 Nm (1.4 m•kg, 10 ft•lb)

TIP

Tighten the bolts in stage, using a crisscross pattern.

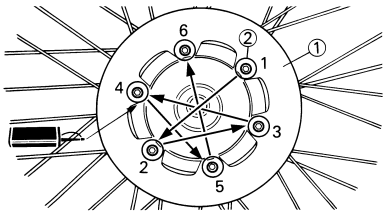

3. Install:

- Rear wheel sprocket "1"
- Bolt (rear wheel sprocket) "2"
- Washer (rear wheel sprocket) "3"
- Nut (rear wheel sprocket) "4"



Nut (rear wheel sprocket):
42 Nm (4.2 m•kg, 30 ft•lb)

TIP

Tighten the nuts in stage, using a crisscross pattern.

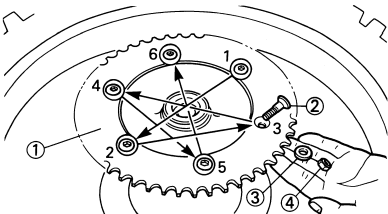

4. Install:

- Collar "1"

TIP

Apply the lithium soap base grease on the oil seal lip.

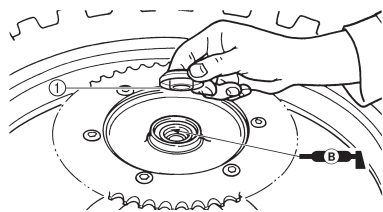

5. Install:

- Wheel

TIP

Install the brake disc "1" between the brake pads "2" correctly.

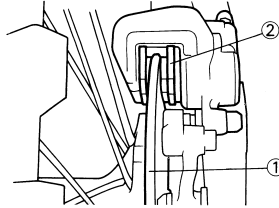

6. Install:

- Drive chain "1"

TIP

Push the wheel "2" forward and install the drive chain.

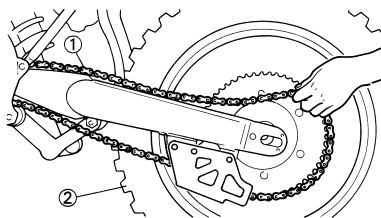

7. Install:

- Left drive chain puller "1"
- Wheel axle "2"

TIP

• Install the left drive chain puller, and insert the wheel axle from left side.
• Apply the lithium soap base grease on the wheel axle.

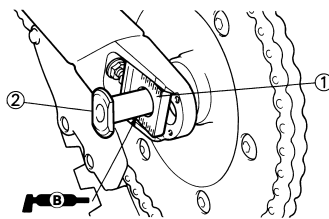

8. Install:

- Right drive chain puller "1"
- Washer "2"
- Nut (wheel axle) "3"

TIP

Temporarily tighten the nut (wheel axle) at this point.

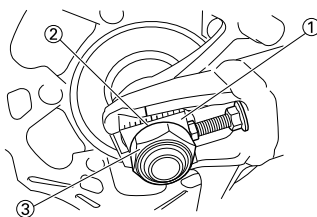

9. Adjust:

- Drive chain slack "a"



Drive chain slack:
50–60 mm (2.0–2.4 in)

Refer to "ADJUSTING THE DRIVE CHAIN SLACK" section in the CHAPTER 3.

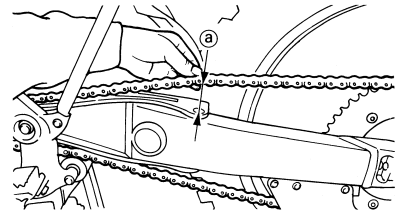

10. Tighten:

- Nut (wheel axle) "1"



Nut (wheel axle):
135 Nm (13.5 m•kg, 98 ft•lb)

- Locknut "2"



Locknut:
21 Nm (2.1 m•kg, 15 ft•lb)

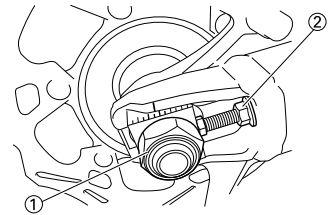

FRONT BRAKE AND REAR BRAKE

FRONT BRAKE AND REAR BRAKE REMOVING THE FRONT BRAKE

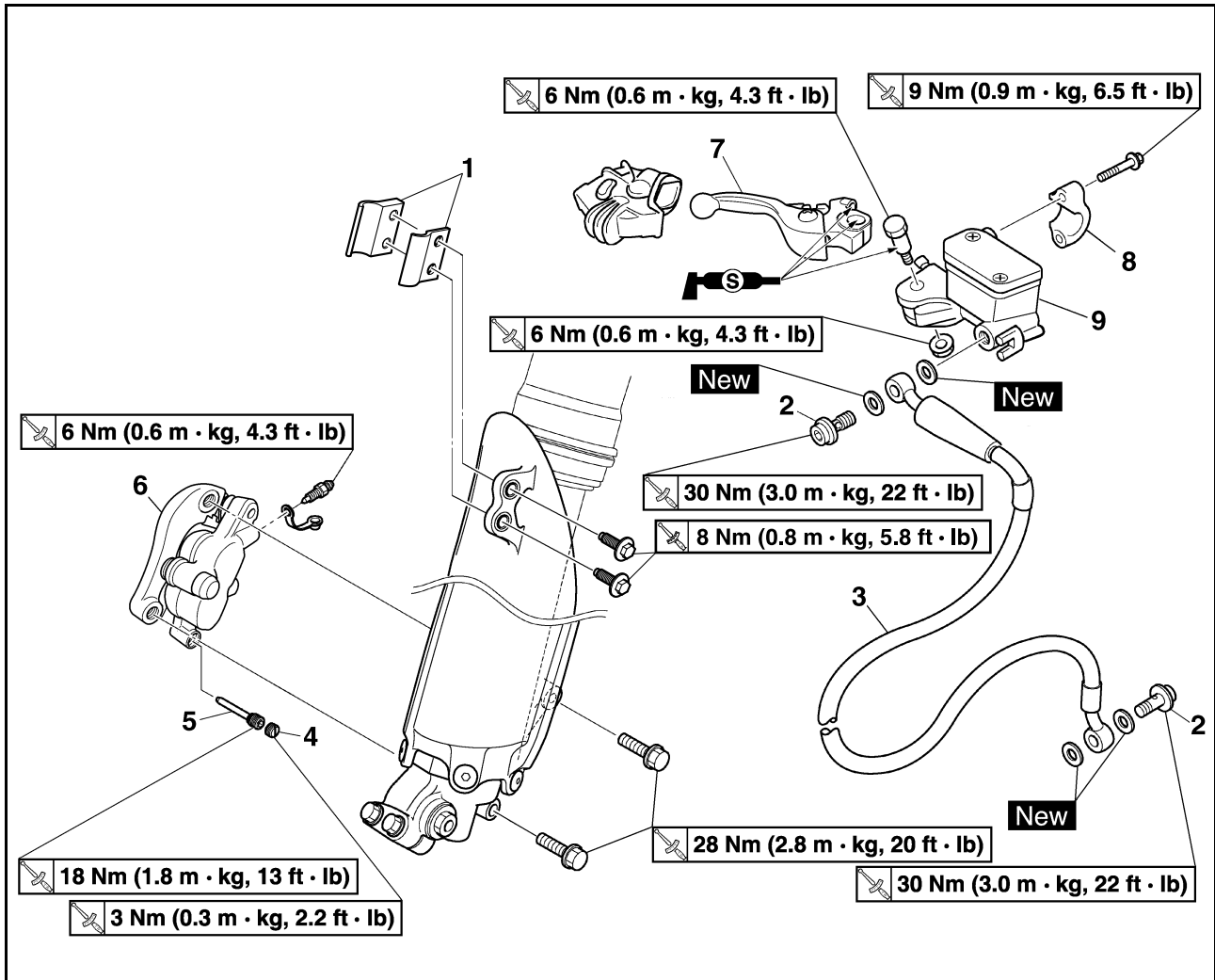

Order	Part name	Q'ty	Remarks
	Hold the machine by placing the suitable stand under the engine.		Refer to "HANDLING NOTE".
	Drain the brake fluid.		Refer to removal section.
1	Brake hose holder (protector)	2	
2	Union bolt	2	
3	Brake hose	1	
4	Pad pin plug	1	Remove when loosening the pad pin.
5	Pad pin	1	Loosen when disassembling the brake caliper.
6	Brake caliper	1	
7	Brake lever	1	
8	Brake master cylinder bracket	1	
9	Brake master cylinder	1	

FRONT BRAKE AND REAR BRAKE

REMOVING THE REAR BRAKE

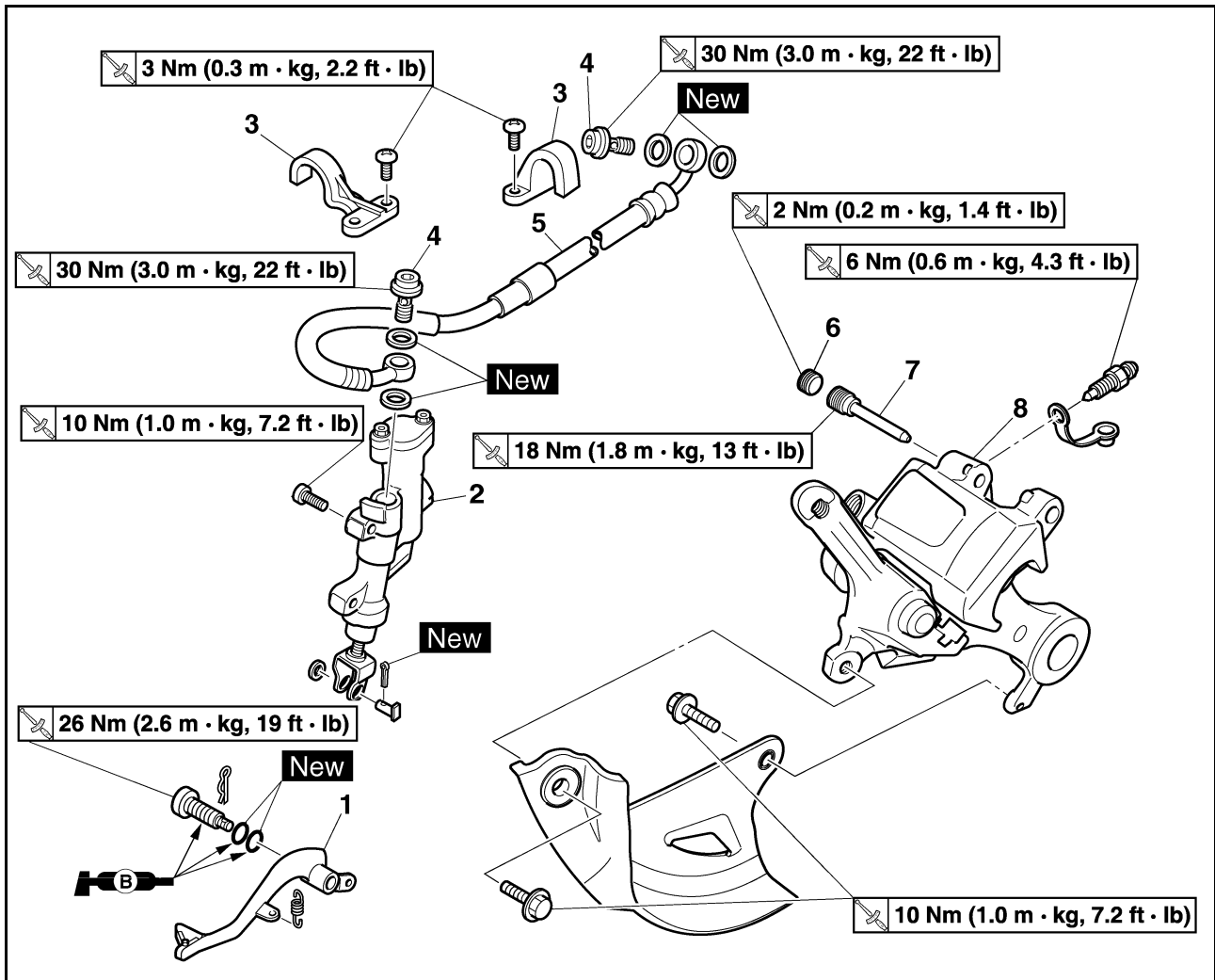

Order	Part name	Q'ty	Remarks
	Hold the machine by placing the suitable stand under the engine.		Refer to "HANDLING NOTE".
	Rear wheel		Refer to "FRONT WHEEL AND REAR WHEEL" section.
	Drain the brake fluid.		Refer to removal section.
1	Brake pedal	1	
2	Brake master cylinder	1	
3	Brake hose holder	2	
4	Union bolt	2	
5	Brake hose	1	
6	Pad pin plug	1	Remove when loosening the pad pin.
7	Pad pin	1	Loosen when disassembling the brake caliper.
8	Brake caliper	1	

FRONT BRAKE AND REAR BRAKE

DISASSEMBLING THE BRAKE CALIPER

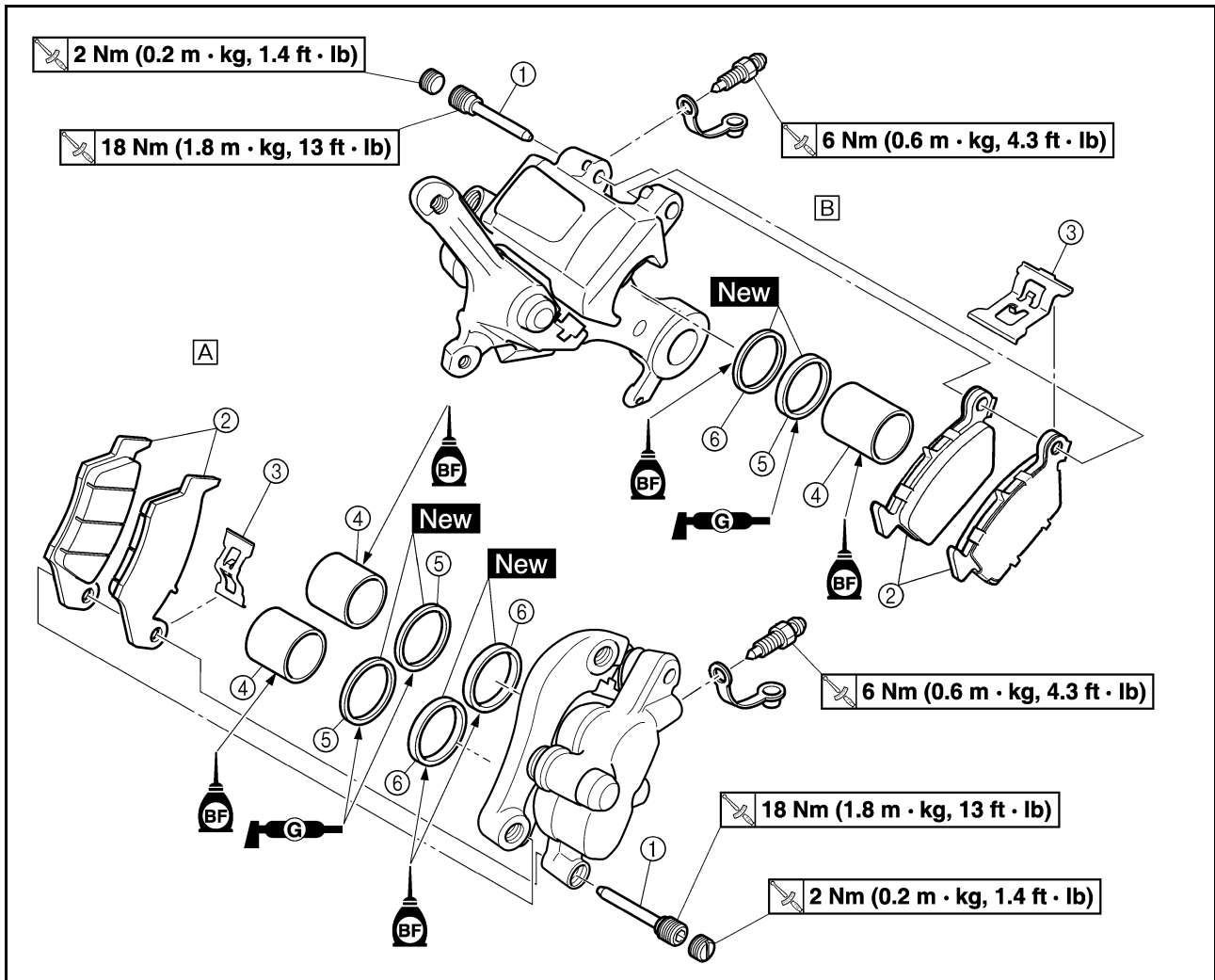

Order	Part name	Q'ty		Remarks
				A. Front B. Rear
		A	B	
1	Pad pin	1	1	
2	Brake pad	2	2	
3	Pad support	1	1	
4	Brake caliper piston	2	1	Refer to removal section.
5	Brake caliper piston dust seal	2	1	Refer to removal section.
6	Brake caliper piston seal	2	1	Refer to removal section.

FRONT BRAKE AND REAR BRAKE

DISASSEMBLING THE BRAKE MASTER CYLINDER

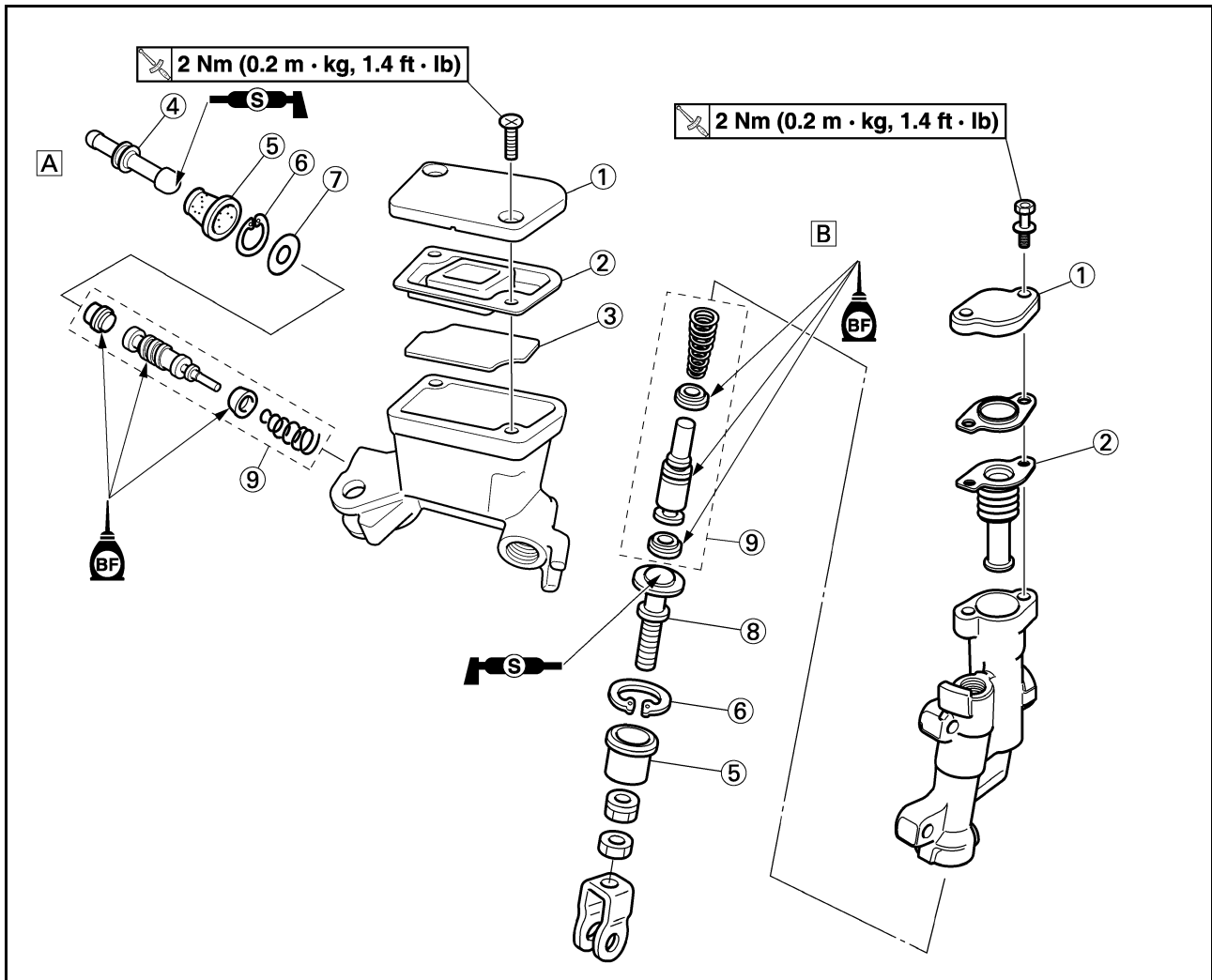

Order	Part name	Q'ty	Remarks
			A. Front B. Rear
1	Brake master cylinder cap	1	
2	Diaphragm	1	
3	Reservoir float	1	
4	Push rod (front)	1	
5	Brake master cylinder boot	1	
6	Circlip	1	Use a long nose circlip pliers.
7	Washer	1	
8	Push rod (rear)	1	
9	Brake master cylinder kit	1	

FRONT BRAKE AND REAR BRAKE

HANDLING NOTE

⚠ WARNING

Support the machine securely so there is no danger of it falling over.

DRAINING THE BRAKE FLUID

- Remove:
 - Brake master cylinder cap "1"
 - Protector (rear brake)

TIP

Do not remove the diaphragm.

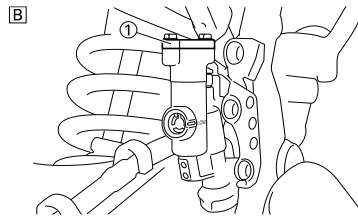
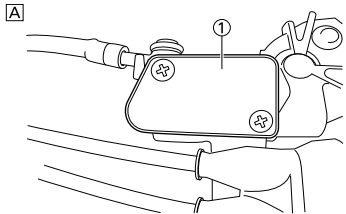

- A. Front
B. Rear

- Connect the transparent hose "2" to the bleed screw "1" and place a suitable container under its end.

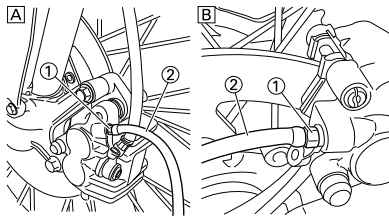

- A. Front
B. Rear

- Loosen the bleed screw and drain the brake fluid while pulling the lever in or pushing down on the pedal.

⚠ WARNING

- Do not reuse the drained brake fluid.
- Brake fluid may erode painted surfaces or plastic parts. Always clean up spilled fluid immediately.

REMOVING THE BRAKE CALIPER PISTON

- Remove:
 - Brake caliper piston
 Use compressed air and proceed carefully.

⚠ WARNING

- Cover piston with rag and use extreme caution when expelling piston from cylinder.
- Never attempt to pry out piston.



Caliper piston removal steps:

- Insert a piece of rag into the brake caliper to lock one brake caliper.
- Carefully force the piston out of the brake caliper cylinder with compressed air.

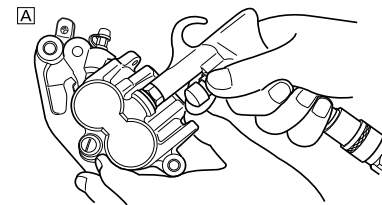

- A. Front
B. Rear



REMOVING THE BRAKE CALIPER PISTON SEAL KIT

- Remove:
 - Brake caliper piston dust seal "1"
 - Brake caliper piston seal "2"

TIP

Remove the brake caliper piston seals and brake caliper piston dust seals by pushing them with a finger.

NOTICE

Never attempt to pry out brake caliper piston seals and brake caliper piston dust seals.

⚠ WARNING

Replace the brake caliper piston seals and brake caliper piston dust seals whenever a caliper is disassembled.

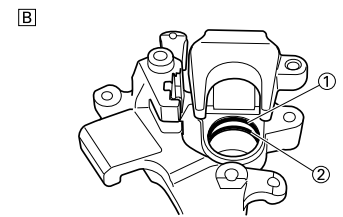
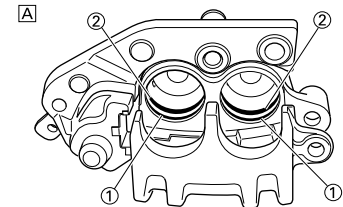

- A. Front
B. Rear

CHECKING THE BRAKE MASTER CYLINDER

- Inspect:
 - Brake master cylinder inner surface "a"
 Wear/scratches → Replace master cylinder assembly.
 Stains → Clean.

⚠ WARNING

Use only new brake fluid.

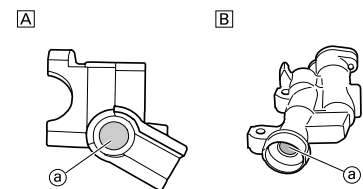

- A. Front
B. Rear

- Inspect:
 - Diaphragm "1"
 Crack/damage → Replace.

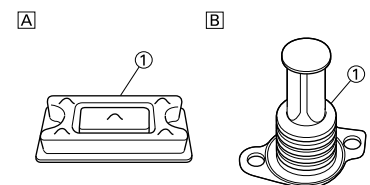

- A. Front
B. Rear

FRONT BRAKE AND REAR BRAKE

3. Inspect: (front brake only)

- Reservoir float "1"
- Damage → Replace.

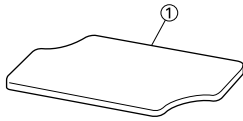

4. Inspect:

- Brake master cylinder piston "1"
- Brake master cylinder cup "2"
- Wear/damage/score marks → Replace brake master cylinder kit.

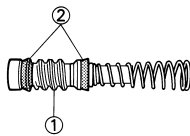

CHECKING THE BRAKE CALIPER

1. Inspect:

- Brake caliper cylinder inner surface "a"
- Wear/score marks → Replace brake caliper assembly.

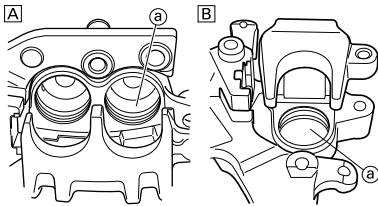

- A. Front
- B. Rear

2. Inspect:

- Brake caliper piston "1"
- Wear/score marks → Replace brake caliper piston assembly.

⚠ WARNING

Replace the brake caliper piston seals and brake caliper piston dust seals "2" whenever a caliper is disassembled.

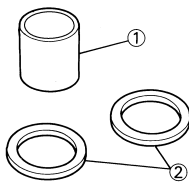

CHECKING THE BRAKE HOSE

1. Inspect:

- Brake hose "1"
- Crack/damage → Replace.

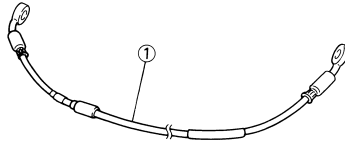

HANDLING NOTE

⚠ WARNING

- All internal parts should be cleaned in new brake fluid only.
- Internal parts should be lubricated with brake fluid when installed.
- Replace the brake caliper piston seals and brake caliper piston dust seals whenever a caliper is disassembled.

INSTALLING THE BRAKE CALIPER PISTON

1. Clean:

- Brake caliper
- Brake caliper piston seal
- Brake caliper piston dust seal
- Brake caliper piston
- Clean them with brake fluid.

2. Install:

- Brake caliper piston seal "1"
- New**
- Brake caliper piston dust seal "2"
- New**

⚠ WARNING

Always use new brake caliper piston seals and brake caliper piston dust seals.

TIP

- Apply the brake fluid on the brake caliper piston seal.
- Apply the silicone grease on the brake caliper piston dust seal.
- Fit the brake caliper piston seals and brake caliper piston dust seals onto the slot on brake caliper correctly.

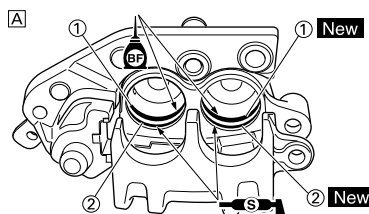

B

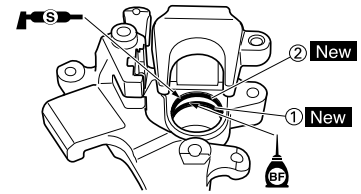

- A. Front
- B. Rear

3. Install:

- Brake caliper piston "1"

TIP

Apply the brake fluid on the piston wall.

NOTICE

- Install the piston with its shallow depressed side "a" facing the brake caliper.
- Never force to insert.

A

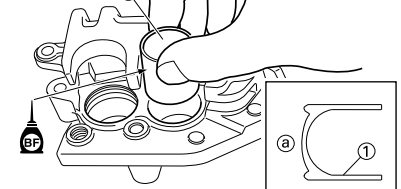

B

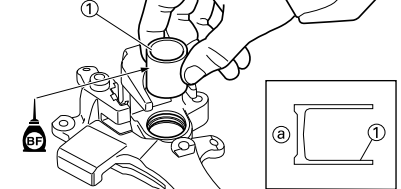

- A. Front
- B. Rear

INSTALLING THE FRONT BRAKE CALIPER

1. Install:

- Pad support "1"
- Brake pad "2"
- Pad pin "3"

TIP

- Install the brake pads with their projections "a" into the brake caliper recesses "b".
- Temporarily tighten the pad pin at this point.

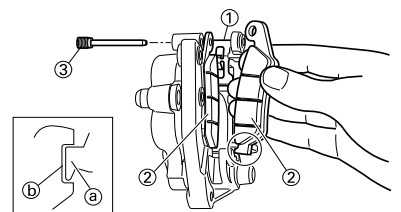

FRONT BRAKE AND REAR BRAKE

2. Install:

- Brake caliper "1"
- Bolt (brake caliper) "2"

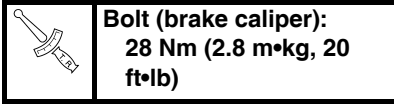

3. Tighten:

- Pad pin "3"

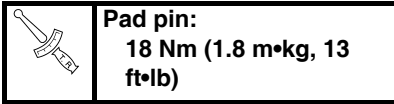

4. Install:

- Pad pin plug "4"

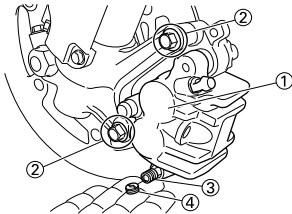
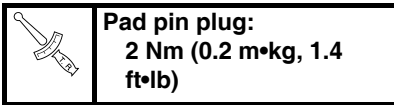

INSTALLING THE REAR BRAKE CALIPER

1. Install:

- Pad support "1"
- Brake pad "2"
- Pad pin "3"

TIP

- Install the brake pads with their projections "a" into the brake caliper recesses "b".
- Temporarily tighten the pad pin at this point.

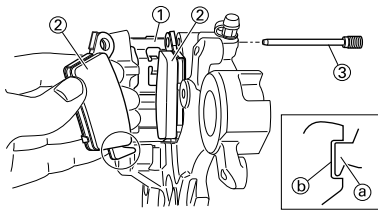

2. Install:

- Brake disc cover "1"
- Bolt (brake disc cover) "2"

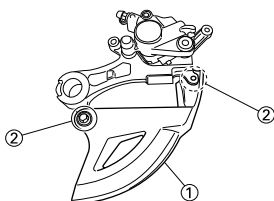
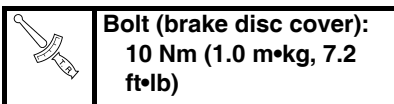

3. Install:

- Brake caliper "1"
 - Rear wheel "2"
- Refer to "FRONT WHEEL AND REAR WHEEL" section.

4. Tighten:

- Pad pin "3"

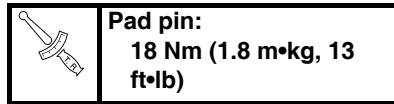

5. Install:

- Pad pin plug "4"

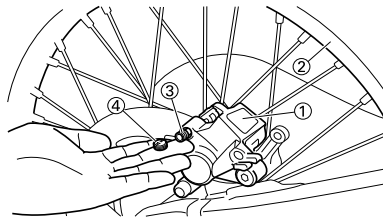
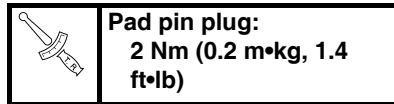

INSTALLING THE BRAKE MASTER CYLINDER KIT

1. Clean:

- Brake master cylinder
 - Brake master cylinder kit
- Clean them with brake fluid.

2. Install:

- Brake master cylinder cup (primary) "1"
 - Brake master cylinder cup (secondary) "2"
- To brake master cylinder piston "3".

TIP

Apply the brake fluid on the brake master cylinder cup.

WARNING

After installing, cylinder cup should be installed as shown direction. Wrong installation cause improper brake performance.

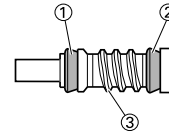
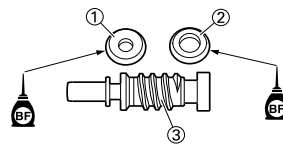

3. Install:

- Spring "1"
- To brake master cylinder piston "2".

TIP

Install the spring at the smaller dia. side.

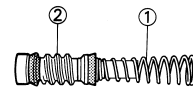

4. Install:

- Brake master cylinder kit "1"
 - Washer (front brake) "2"
 - Push rod (rear brake) "2"
 - Circlip "3"
 - Brake master cylinder boot "4"
 - Push rod (front brake) "5"
- To brake master cylinder.

TIP

- Apply the brake fluid on the brake master cylinder kit.
- Apply the silicone grease on the tip of the push rod.
- When installing the circlip, use a long nose circlip pliers.

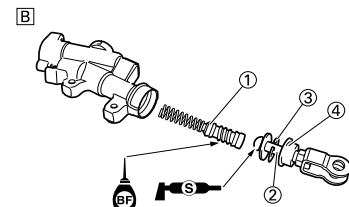
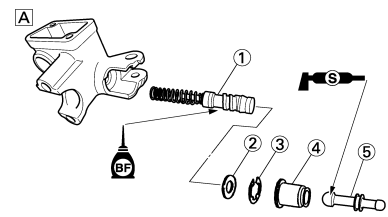

- A. Front
- B. Rear

FRONT BRAKE AND REAR BRAKE

INSTALLING THE FRONT BRAKE MASTER CYLINDER

1. Install:
 - Brake master cylinder "1"
 - Brake master cylinder bracket "2"
 - Bolt (brake master cylinder bracket) "3"

	Bolt (brake master cylinder bracket): 9 Nm (0.9 m•kg, 6.5 ft•lb)
---	--

TIP

- Install the bracket so that the arrow mark "a" face upward.
- First tighten the bolts on the upper side of the brake master cylinder bracket, and then tighten the bolts on the lower side.

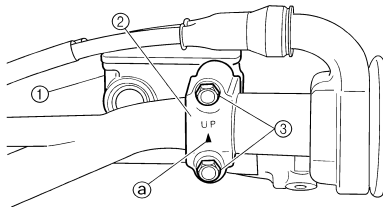

2. Install:
 - Brake lever "1"
 - Bolt (brake lever) "2"

	Bolt (brake lever): 6 Nm (0.6 m•kg, 4.3 ft•lb)
---	--

- Nut (brake lever) "3"

	Nut (brake lever): 6 Nm (0.6 m•kg, 4.3 ft•lb)
---	---

TIP

Apply the silicone grease on the brake lever sliding surface, bolt and tip of the push rod.

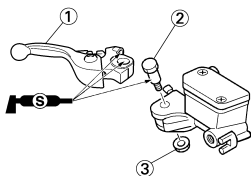

INSTALLING THE REAR BRAKE MASTER CYLINDER

1. Install:
 - Copper washer "1" **New**
 - Brake hose "2"
 - Union bolt "3"

	Union bolt: 30 Nm (3.0 m•kg, 22 ft•lb)
---	--

WARNING

Always use new copper washers.

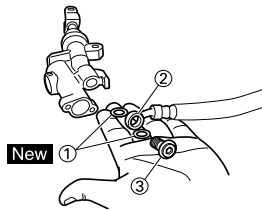

NOTICE

Install the brake hose so that its pipe portion "a" directs as shown and lightly touches the projection "b" on the brake master cylinder.

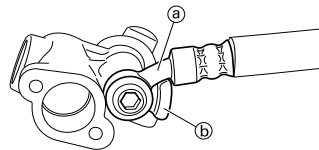

2. Install:
 - Brake master cylinder "1"
 - Bolt (brake master cylinder) "2"

	Bolt (brake master cylinder): 10 Nm (1.0 m•kg, 7.2 ft•lb)
---	---

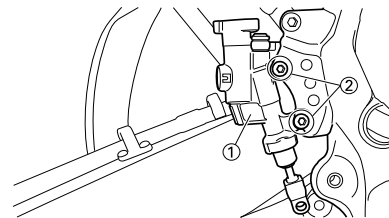

3. Install:
 - Spring "1"
 - Brake pedal "2"
 - O-ring "3" **New**
 - Bolt (brake pedal) "4"

	Bolt (brake pedal): 26 Nm (2.6 m•kg, 19 ft•lb)
---	--

- Clip "5"

TIP

Apply the lithium soap base grease on the bolt, O-ring and brake pedal bracket.

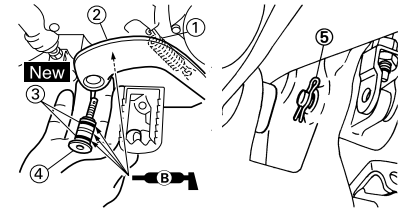

4. Install:
 - Pin "1"
 - Washer "2"
 - Cotter pin "3" **New**

TIP

After installing, check the brake pedal height. Refer to "ADJUSTING THE REAR BRAKE" section in the CHAPTER 3.

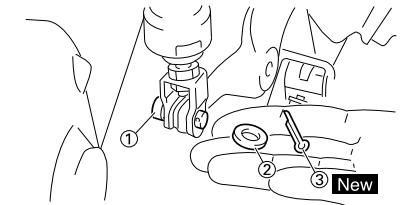

INSTALLING THE FRONT BRAKE HOSE

1. Install:
 - Copper washer "1" **New**
 - Brake hose "2"
 - Union bolt "3"

	Union bolt: 30 Nm (3.0 m•kg, 22 ft•lb)
---	--

WARNING

Always use new copper washers.

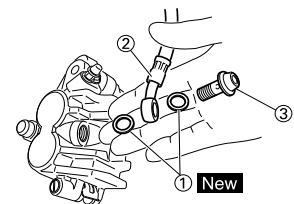

FRONT BRAKE AND REAR BRAKE

NOTICE

Install the brake hose so that its pipe portion "a" directs as shown and lightly touches the projection "b" on the brake caliper.

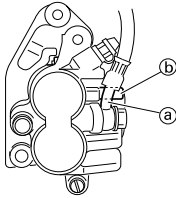

2. Install:

- Brake hose holder "1"
- Bolt (brake hose holder) "2"



Bolt (brake hose holder):
8 Nm (0.8 m•kg, 5.8 ft
•lb)

TIP

Align the top "a" of the brake hose holder with the paint "b" of the brake hose.

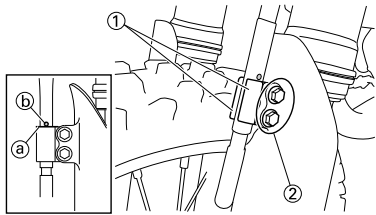

3. Pass the brake hose through the cable guide "1".

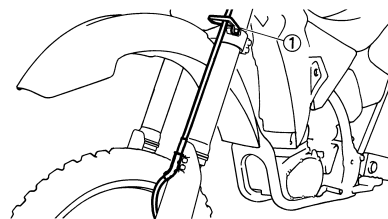

4. Install:

- Copper washer "1" **New**
- Brake hose "2"
- Union bolt "3"



Union bolt:
30 Nm (3.0 m•kg, 22
ft•lb)

WARNING

Always use new copper washers.

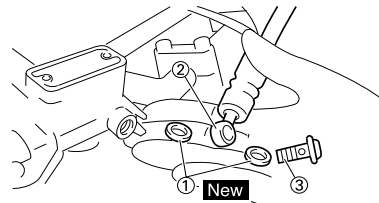

NOTICE

Install the brake hose so that its pipe portion "a" directs as shown and lightly touches the projection "b" on the brake master cylinder.

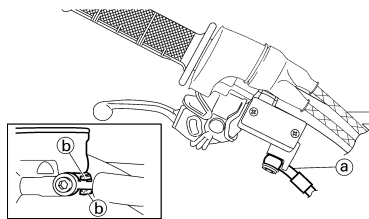

INSTALLING THE REAR BRAKE HOSE

1. Install:

- Copper washer "1" **New**
- Brake hose "2"
- Union bolt "3"



Union bolt:
30 Nm (3.0 m•kg, 22
ft•lb)

WARNING

Always use new copper washers.

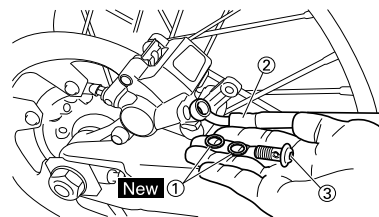

NOTICE

Install the brake hose so that its pipe portion "a" directs as shown and lightly touches the projection "b" on the brake caliper.

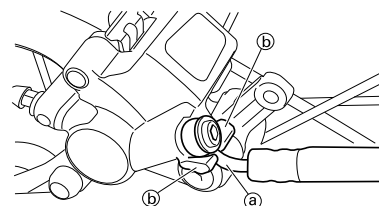

2. Install:

- Brake hose holder "1"
- Screw (brake hose holder) "2"



Screw (brake hose holder):
3 Nm (0.3 m•kg, 2.2
ft•lb)

NOTICE

After installing the brake hose holders, make sure the brake hose does not contact the spring (rear shock absorber). If it does, correct its twist.

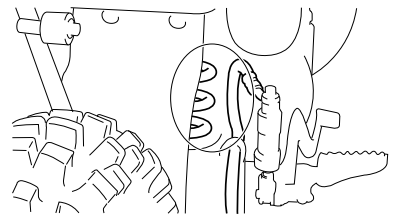
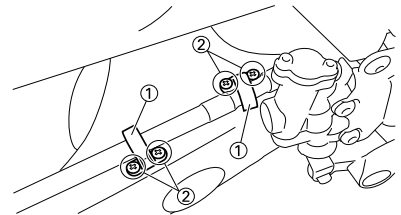

FILLING THE BRAKE FLUID

1. Fill:

- Brake fluid
- Until the fluid level reaches "LOWER" level line "a".



Recommended brake fluid:
DOT #4

WARNING

- Use only the designated quality brake fluid: otherwise, the rubber seals may deteriorate, causing leakage and poor brake performance.
- Refill with the same type of brake fluid; mixing fluids may result in a harmful chemical reaction and lead to poor performance.
- Be careful that water does not enter the master cylinder when refilling. Water will significantly lower the boiling point of the fluid and may result in vapor lock.

FRONT BRAKE AND REAR BRAKE

NOTICE

Brake fluid may erode painted surfaces or plastic parts. Always clean up spilled fluid immediately.

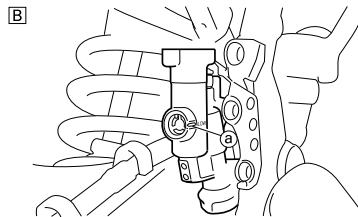
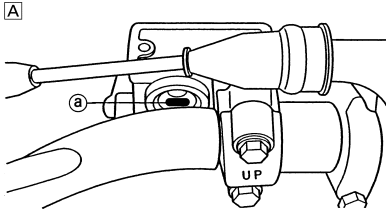

A. Front

B. Rear

2. Air bleed:

- Brake system

Refer to "BLEEDING THE HYDRAULIC BRAKE SYSTEM" section in the CHAPTER 3.

3. Inspect:

- Brake fluid level

Fluid at lower level → Fill up.

Refer to "CHECKING THE BRAKE FLUID LEVEL" section in the CHAPTER 3.

4. Install:

- Reservoir float (front brake)
- Diaphragm
- Brake master cylinder cap "1"
- Screw (bolt) {brake master cylinder cap} "2"



**Screw (bolt) {brake master cylinder cap}:
2 Nm (0.2 m•kg, 1.4 ft•lb)**

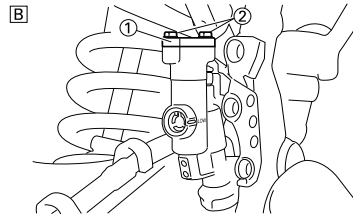
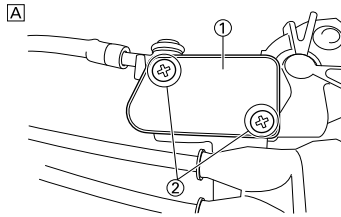

A. Front

B. Rear

5. Install: (rear brake only)

- Protector "1"
- Bolt (protector) "2"



**Bolt (protector):
7 Nm (0.7 m•kg, 5.1 ft•lb)**

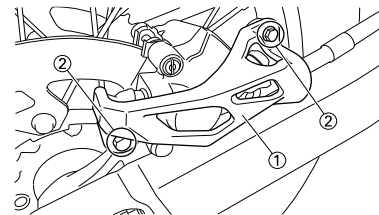

⚠ WARNING

After installation, while pulling the brake lever in or pushing down on the brake pedal, check whether there is any brake fluid leaking where the union bolts are installed respectively at the brake master cylinder and brake caliper.

FRONT FORK

FRONT FORK

REMOVING THE FRONT FORK

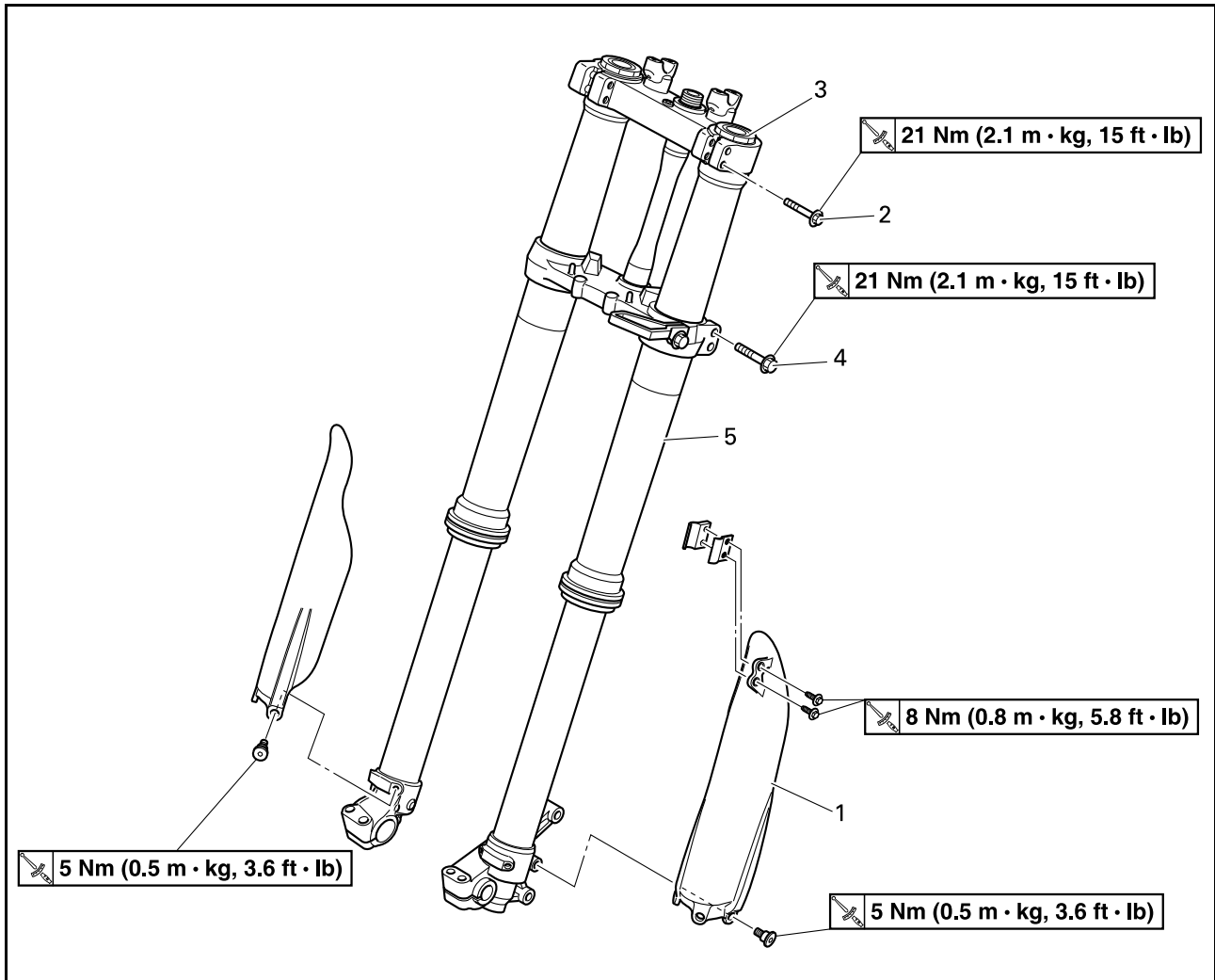

Order	Part name	Q'ty	Remarks
	Hold the machine by placing the suitable stand under the engine.		Refer to "HANDLING NOTE".
	Front wheel		Refer to "FRONT WHEEL AND REAR WHEEL" section.
	Front brake caliper		Refer to "FRONT BRAKE AND REAR BRAKE" section.
	Number plate		Refer to "SEAT, FUEL TANK AND SIDE COVERS" section in the CHAPTER 4.
1	Protector	1	
2	Pinch bolt (upper bracket)	2	Only loosening.
3	Damper assembly	1	Loosen when disassembling the front fork. Refer to removal section.
4	Pinch bolt (lower bracket)	2	Only loosening.
5	Front fork	1	

FRONT FORK

DISASSEMBLING THE FRONT FORK

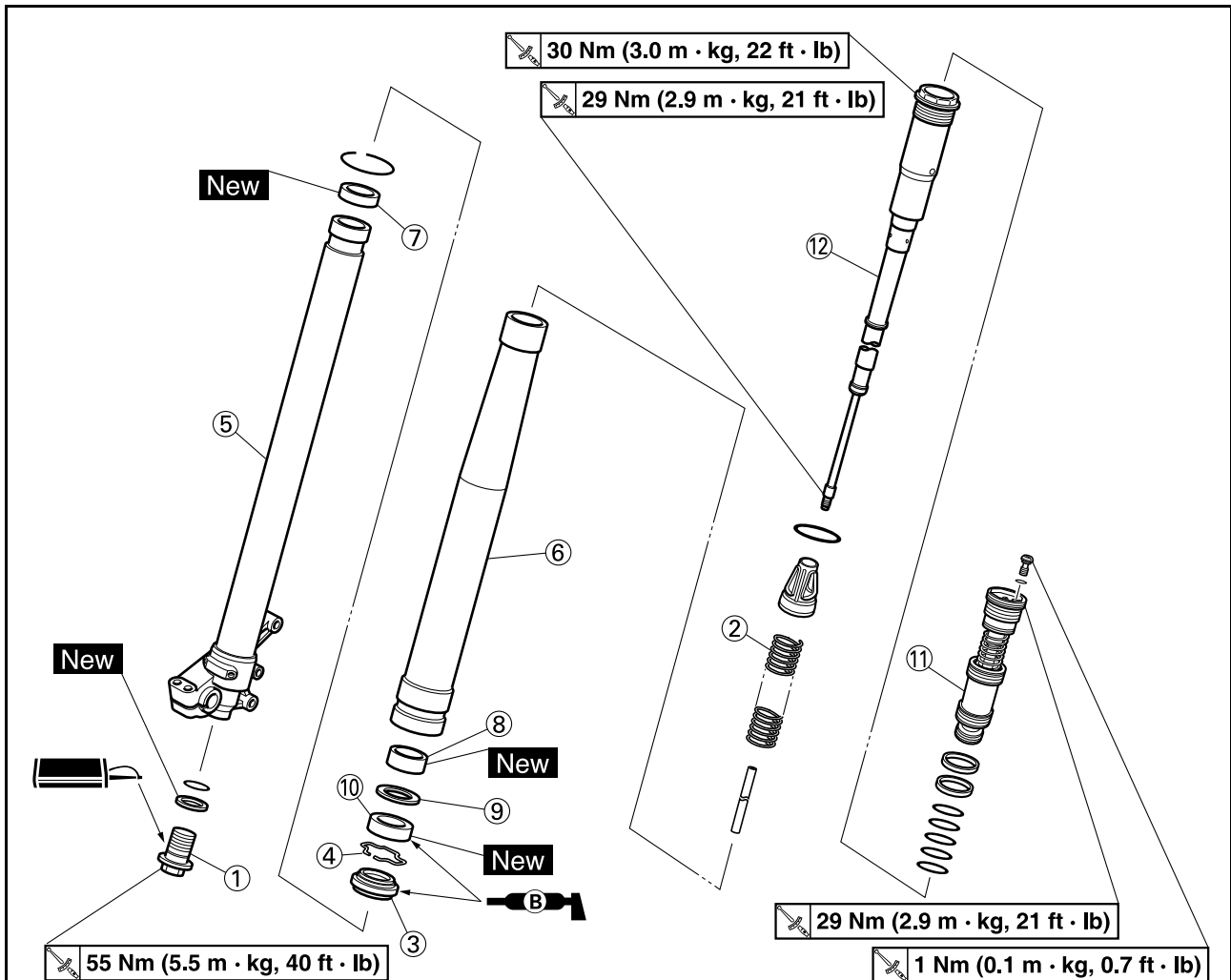

Order	Part name	Q'ty	Remarks
1	Adjuster	1	Drain the fork oil. Refer to removal section.
2	Fork spring	1	
3	Dust seal	1	Refer to removal section.
4	Stopper ring	1	Refer to removal section.
5	Inner tube	1	Refer to removal section.
6	Outer tube	1	
7	Piston metal	1	
8	Slide metal	1	
9	Oil seal washer	1	
10	Oil seal	1	
11	Base valve	1	Drain the fork oil. Refer to removal section.
12	Damper assembly	1	Drain the fork oil. Refer to removal section.

HANDLING NOTE

⚠ WARNING

Support the machine securely so there is no danger of it falling over.

TIP

The front fork requires careful attention. So it is recommended that the front fork be maintained at the dealers.

NOTICE

To prevent an accidental explosion of air, the following instructions should be observed:

- The front fork with a built-in piston rod has a very sophisticated internal construction and is particularly sensitive to foreign material. Use enough care not to allow any foreign material to come in when the oil is replaced or when the front fork is disassembled and reassembled.
- Before removing the base valves or front forks, be sure to extract the air from the air chamber completely.

REMOVING THE DAMPER ASSEMBLY

- Loosen:
 - Damper assembly "1"

TIP

Before removing the front fork from the machine, loosen the damper assembly with the cap bolt ring wrench "2".



Cap bolt ring wrench:
YM-01501/90890-01501

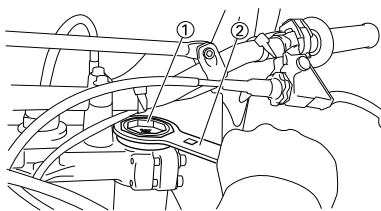

REMOVING THE ADJUSTER

- Drain the outer tube of its front fork oil at its top.
- Loosen:
 - Adjuster "1"

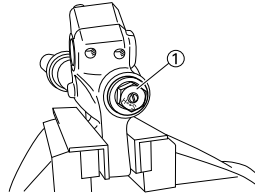

- Remove:
 - Adjuster "1"

TIP

- While compressing the inner tube "2", set the cap bolt ring wrench "4" between the inner tube and locknut "3".
- Hold the locknut and remove the adjuster.

NOTICE

Do not remove the locknut as the damper rod may go into the damper assembly and not be taken out.



Cap bolt ring wrench:
YM-01501/90890-01501

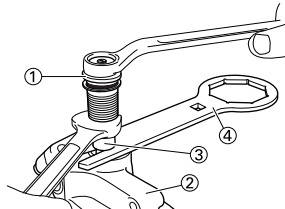

REMOVING THE INNER TUBE

- Remove:
 - Dust seal "1"
 - Stopper ring "2"
 Using slotted-head screwdriver.

NOTICE

Take care not to scratch the inner tube.

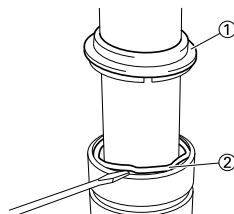

- Remove:
 - Inner tube "1"



Oil seal removal steps:

- Push in slowly "a" the inner tube just before it bottoms out and then pull it back quickly "b".
- Repeat this step until the inner tube can be pulled out from the outer tube.

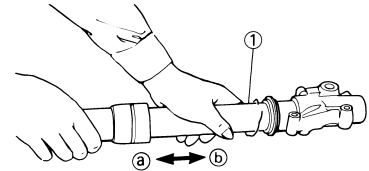

REMOVING THE BASE VALVE

- Remove:
 - Base valve "1"
 From damper assembly "2".

TIP

Hold the damper assembly with the cap bolt ring wrench "3" and use the cap bolt wrench "4" to remove the base valve.



Cap bolt wrench:
YM-01500/90890-01500
Cap bolt ring wrench:
YM-01501/90890-01501

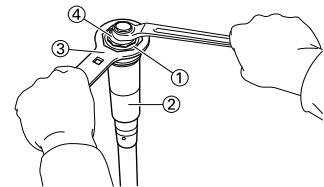

CHECKING THE DAMPER ASSEMBLY

- Inspect:
 - Damper assembly "1"
Bend/damage → Replace.
 - O-ring "2"
Wear/damage → Replace.

FRONT FORK

NOTICE

The front fork with a built-in piston rod has a very sophisticated internal construction and is particularly sensitive to foreign material. Use enough care not to allow any foreign material to come in when the oil is replaced or when the front fork is disassembled and re-assembled.

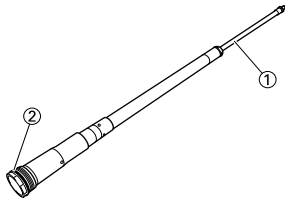

CHECKING THE BASE VALVE

- Inspect:
 - Base valve "1"
Wear/damage → Replace.
Contamination → Clean.
 - O-ring "2"
Wear/damage → Replace.
 - Piston metal "3"
Wear/damage → Replace.
 - Spring "4"
Damage/fatigue → Replace base valve.
 - Air bleed screw "5"
Wear/damage → Replace.

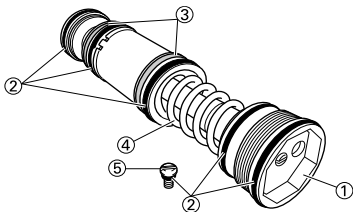

CHECKING THE COLLAR For USA and CDN

- Inspect:
 - Piston metal "1"
Wear/damage → Replace.

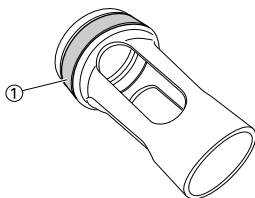

Except for USA and CDN

- Inspect:
 - Contacting surface "a"
Wear/damage → Replace.

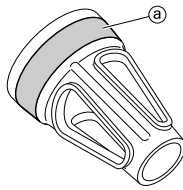

CHECKING THE FORK SPRING

- Measure:
 - Fork spring free length "a"
Out of specification → Replace.

	Fork spring free length: 470 mm (18.5 in) <Limit>: 465 mm (18.3 in)
---	--

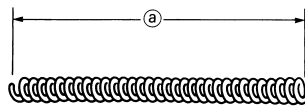

CHECKING THE INNER TUBE

- Inspect:
 - Inner tube surface "a"
Score marks → Repair or replace.
Use #1,000 grit wet sandpaper.
Damaged oil lock piece → Replace.
 - Inner tube bends
Out of specification → Replace.
Use the dial gauge "1".

	Inner tube bending limit: 0.2 mm (0.008 in)
---	---

TIP
The bending value is shown by one half of the dial gauge reading.

WARNING
Do not attempt to straighten a bent inner tube as this may dangerously weaken the tube.

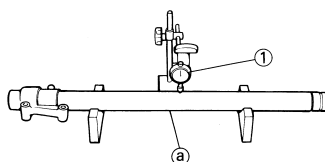

CHECKING THE OUTER TUBE

- Inspect:
 - Outer tube "1"
Score marks/wear/damage → Replace.

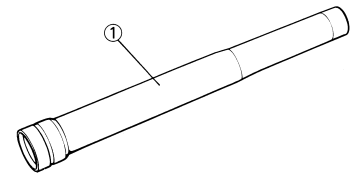

CHECKING THE ADJUSTER

- Inspect:
 - Adjuster "1"
 - O-ring "2"
Wear/damage → Replace.

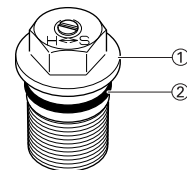

ASSEMBLING THE FRONT FORK

- Wash the all parts in a clean solvent.
- Stretch the damper assembly fully.
- Fill:
 - Front fork oil "1"
To damper assembly.

	Recommended oil: Suspension oil "S1" Oil capacity: 204 cm ³ (7.18 Imp oz, 6.90 US oz)
---	--

- NOTICE**
- Be sure to use recommended fork oil. If other oils are used, they may have an excessively adverse effect on the front fork performance.
 - Never allow foreign materials to enter the front fork.

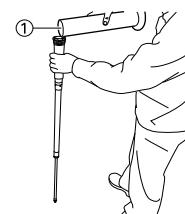

- After filling, pump the damper assembly "1" slowly up and down (about 200 mm (7.9 in) stroke) several times to bleed the damper assembly of air.

TIP
Be careful not to excessive full stroke. A stroke of 200 mm (7.9 in) or more will cause air to enter. In this case, repeat the steps 2 to 4.

FRONT FORK

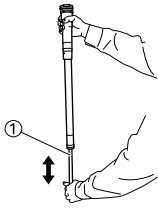

5. Measure:

- Oil level (left and right) "a"
Out of specification → Adjust.

	Standard oil level:
	145-148 mm (5.71-5.83 in) From top of fully stretched damper assembly.

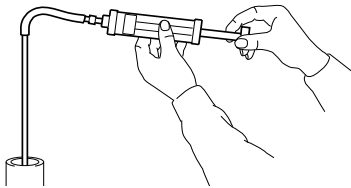
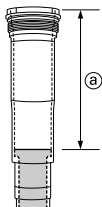

6. Tighten:

- Locknut "1"

TIP

Fully finger tighten the locknut onto the damper assembly.

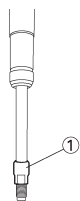

7. Loosen:

- Compression damping adjuster "1"

TIP

- Loosen the compression damping adjuster finger tight.
- Record the set position of the adjuster (the amount of turning out the fully turned in position).

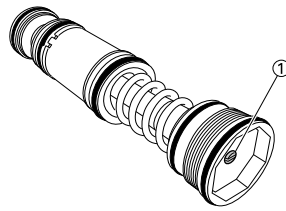

8. Install:

- Base valve "1"
To damper assembly "2".

TIP

First bring the damper rod pressure to a maximum. Then install the base valve while releasing the damper rod pressure.

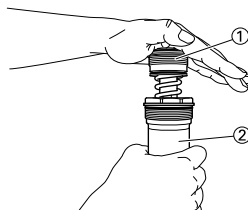

9. Check:

- Damper assembly
Not fully stretched → Repeat the steps 2 to 8.

10. Tighten:

- Base valve "1"



Base valve:

29 Nm (2.9 m•kg, 21 ft•lb)

TIP

Hold the damper assembly with the cap bolt ring wrench "2" and use the cap bolt wrench "3" to tighten the base valve with specified torque.



Cap bolt wrench:

YM-01500/90890-01500

Cap bolt ring wrench:

YM-01501/90890-01501

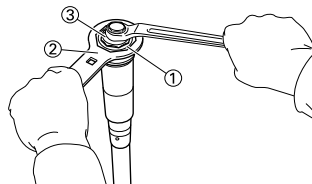

11. After filling, pump the damper assembly "1" slowly up and down more than 10 times to distribute the fork oil.

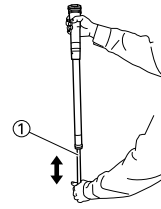

12. While protecting the damper assembly "1" with a rag and compressing fully, allow excessive oil to overflow on the base valve side.

NOTICE

Take care not to damage the damper assembly.



13. Allow the overflowing oil to escape at the hole "a" in the damper assembly.

TIP

The overflow measures about 8 cm³ (0.28 Imp oz, 0.27 US oz).

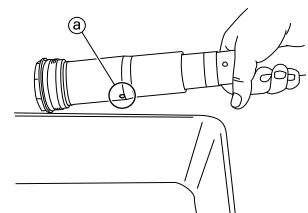

14. Check:

- Damper assembly smooth movement
Tightness/binding/rough spots → Repeat the steps 2 to 13.



FRONT FORK

15. Install:

- Dust seal "1"
 - Stopper ring "2"
 - Oil seal "3" **New**
 - Oil seal washer "4"
 - Slide metal "5" **New**
- To inner tube "6".

TIP

- Apply the fork oil on the inner tube.
- When installing the oil seal, use vinyl seat "a" with fork oil applied to protect the oil seal lip.
- Install the oil seal with its manufacturer's marks or number facing the axle holder side.

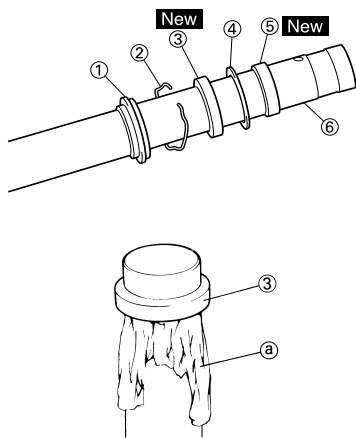

16. Install:

- Piston metal "1" **New**

TIP

Install the piston metal onto the slot on inner tube.

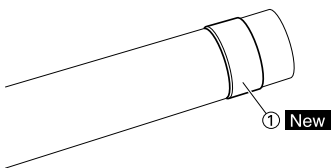

17. Install:

- Outer tube "1"
- To inner tube "2".

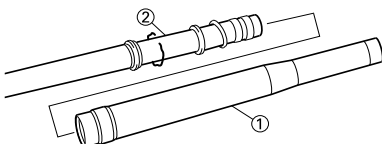

18. Install:

- Slide metal "1"
 - Oil seal washer "2"
- To outer tube slot.

TIP

Press the slide metal into the outer tube with fork seal driver "3".

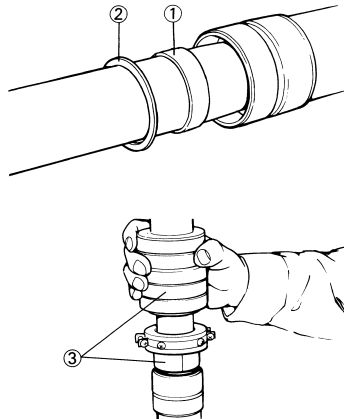
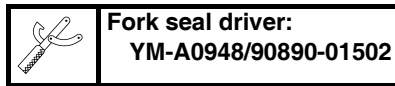

19. Install:

- Oil seal "1"

TIP

Press the oil seal into the outer tube with fork seal driver "2".

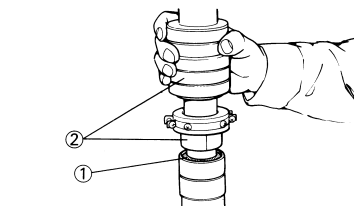
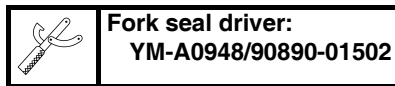

20. Install:

- Stopper ring "1"

TIP

Fit the stopper ring correctly in the groove in the outer tube.

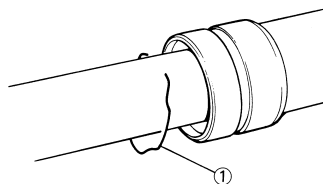

21. Install:

- Dust seal "1"

TIP

Apply the lithium soap base grease on the inner tube.

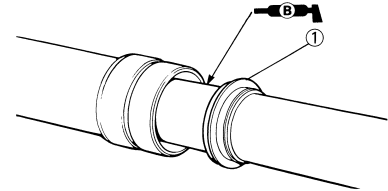

22. Check:

- Inner tube smooth movement
- Tightness/binding/rough spots → Repeat the steps 15 to 21.

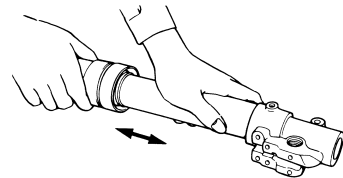

23. Measure:

- Distance "a"
- Out of specification → Turn into the locknut.

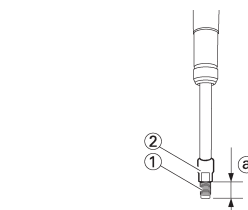
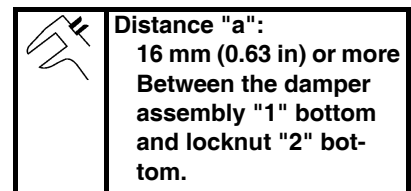

24. Install:

- Collar "1"
 - Fork spring "2"
- To damper assembly "3".

TIP

Install the collar with its larger dia. end "a" facing the fork spring.

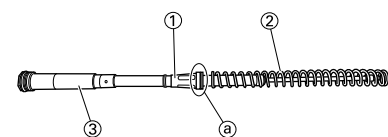

FRONT FORK

25. Install:
- Damper assembly "1"
To inner tube "2".

NOTICE

To install the damper assembly into the inner tube, hold the inner tube aslant. If the inner tube is held vertically, the damper assembly may fall into it, damaging the valve inside.

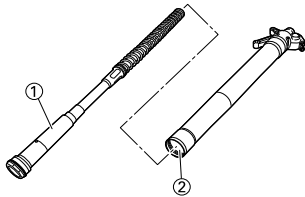

26. Loosen:
- Rebound damping adjuster "1"

TIP

- Loosen the rebound damping adjuster finger tight.
- Record the set position of the adjuster (the amount of turning out the fully turned in position).

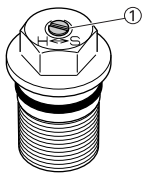

27. Install:
- Push rod "1"
 - Copper washer "2" **New**
 - Adjuster "3"
- To damper assembly "4".

TIP

- While compressing the inner tube "5", set the cap bolt ring wrench "7" between the inner tube and locknut "6".
- Fully finger tighten the adjuster onto the damper assembly.

Cap bolt ring wrench:
YM-01501/90890-01501

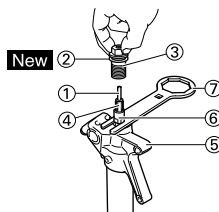

28. Inspect:
- Gap "a" between the adjuster "1" and locknut "2".
- Out of specification → Retighten and readjust the locknut.

Gap "a" between the adjuster and locknut:
0.5–1.0 mm (0.02–0.04 in)

TIP

If the adjuster is installed out of specification, proper damping force cannot be obtained.

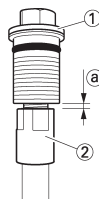

29. Tighten:
- Adjuster (locknut) "1"

Adjuster (locknut):
29 Nm (2.9 m•kg, 21 ft•lb)

TIP

Hold the locknut "2" and tighten the adjuster with specified torque.

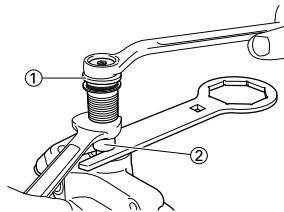

30. Install:
- Adjuster "1"

Adjuster:
55 Nm (5.5 m•kg, 40 ft•lb)

To inner tube.

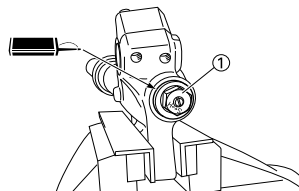

31. Fill:
- Front fork oil "1"
From outer tube top.

Recommended oil:
Suspension oil "S1"
Standard oil amount:
355 cm³ (12.5 Imp oz,
12.0 US oz)
Extent of adjustment:
300–365 cm³
(10.6–12.8 Imp oz,
10.1–12.3 US oz)

WARNING

Never fail to make the oil amount adjustment between the maximum and minimum amount and always adjust each front fork to the same setting. Uneven adjustment can cause poor handling and loss of stability.

NOTICE

- Be sure to use recommended fork oil. If other oils are used, they may have an excessively adverse effect on the front fork performance.
- Never allow foreign materials to enter the front fork.

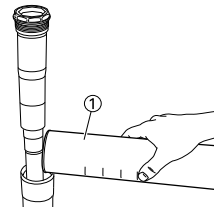

32. Install:
- Damper assembly "1"
To outer tube.

TIP

Temporarily tighten the damper assembly.

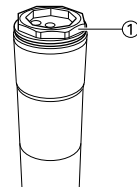

FRONT FORK

33. Install:

- Protector guide "1"

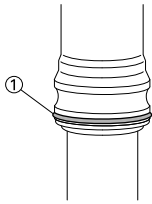

INSTALLING THE FRONT FORK

1. Install:

- Front fork "1"

TIP

- Temporarily tighten the pinch bolts (lower bracket).
- Do not tighten the pinch bolts (upper bracket) yet.

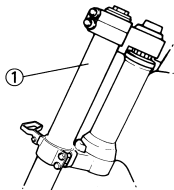

2. Tighten:

- Damper assembly "1"



Damper assembly:
30 Nm (3.0 m•kg, 22 ft•lb)

TIP

Use the cap bolt ring wrench "2" to tighten the damper assembly with specified torque.



Cap bolt ring wrench:
YM-01501/90890-01501

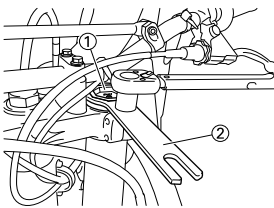

3. Adjust:

- Front fork top end "a"



Front fork top end (standard) "a":
Zero mm (Zero in)

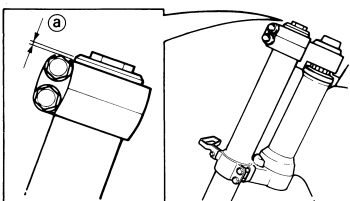

4. Tighten:

- Pinch bolt (upper bracket) "1"



Pinch bolt (upper bracket):
21 Nm (2.1 m•kg, 15 ft•lb)

- Pinch bolt (lower bracket) "2"



Pinch bolt (lower bracket):
21 Nm (2.1 m•kg, 15 ft•lb)

⚠ WARNING

Tighten the lower bracket to specified torque. If torqued too much, it may cause the front fork to malfunction.

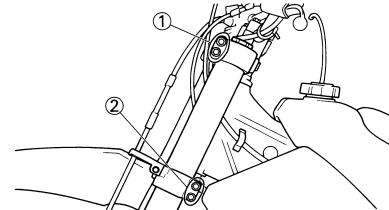

5. Install:

- Protector "1"
- Bolt (protector) "2"



Bolt (protector):
5 Nm (0.5 m•kg, 3.6 ft•lb)

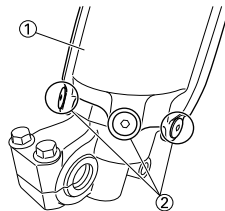

6. Adjust:

- Rebound damping force

TIP

Turn in the damping adjuster "1" finger-tight and then turn out to the originally set position.

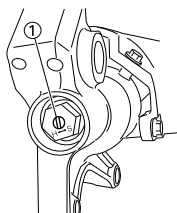

7. Adjust:

- Compression damping force

TIP

Turn in the damping adjuster "1" finger-tight and then turn out to the originally set position.

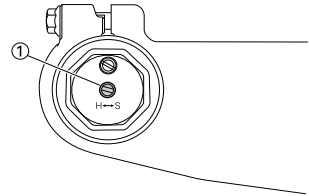

HANDLEBAR

REMOVING THE HANDLEBAR

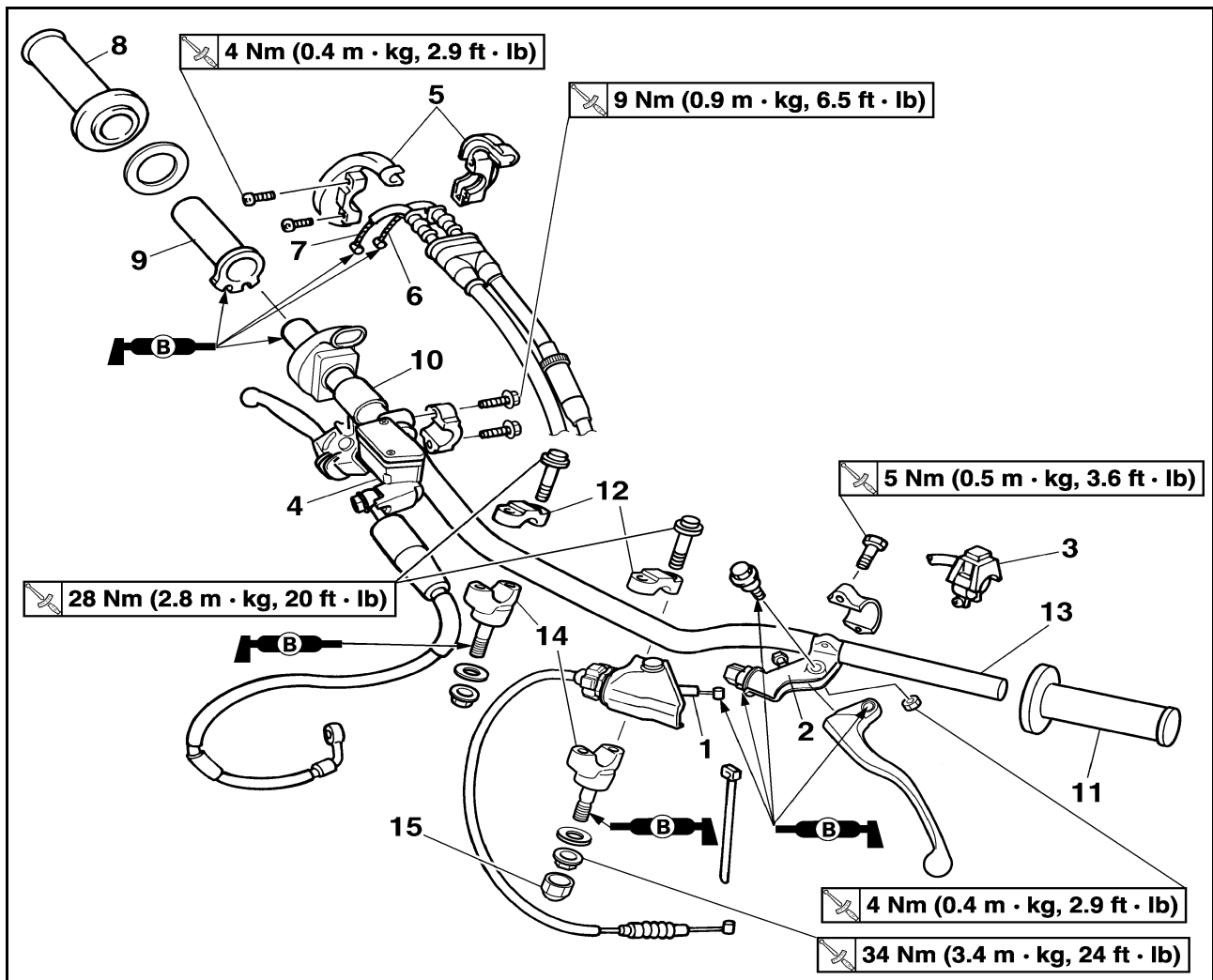

Order	Part name	Q'ty	Remarks
	Number plate		Remove the band only.
1	Clutch cable	1	Disconnect at the lever side.
2	Clutch lever holder	1	
3	Engine stop switch	1	
4	Brake master cylinder	1	Refer to removal section.
5	Throttle cable cap	1	
6	Throttle cable #1 (pulled)	1	Disconnect at the throttle side.
7	Throttle cable #2 (pushed)	1	Disconnect at the throttle side.
8	Right grip	1	Refer to removal section.
9	Tube guide	1	
10	Collar	1	
11	Left grip	1	Refer to removal section.
12	Handlebar upper holder	2	
13	Handlebar	1	
14	Handlebar lower holder	2	
15	Cap	1	

REMOVING THE BRAKE MASTER CYLINDER

- Remove:
 - Brake master cylinder bracket "1"
 - Brake master cylinder "2"

NOTICE

- Do not let the brake master cylinder hang on the brake hose.
- Keep the brake master cylinder cap side horizontal to prevent air from coming in.

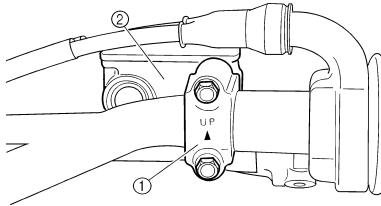

REMOVING THE GRIP

- Remove:
 - Grip "1"

TIP

Blow in air between the handlebar or tube guide and the grip. Then remove the grip which has become loose.

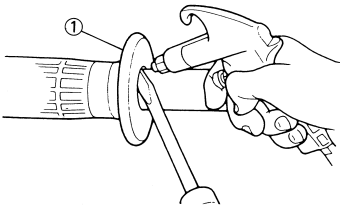

CHECKING THE HANDLEBAR

- Inspect:
 - Handlebar "1"
 Bends/cracks/damage → Replace.

WARNING

Do not attempt to straighten a bent handlebar as this may dangerously weaken the handlebar.

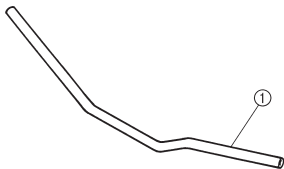

INSTALLING THE HANDLEBAR

- Install:
 - Handlebar lower holder "1"
 - Washer "2"
 - Nut (handlebar lower holder) "3"

TIP

- Be sure the side of the handlebar lower holder having the greater distance "a" from the mounting bolt center faces forward. And install it in the hole "b" in the rear of the upper bracket.
- Apply the lithium soap base grease on the thread of the handlebar lower holder.
- Change in the direction back to front and installing position of the handlebar lower holder allows the front-to-rear offset amount of the handlebar position to be changed.
- Do not tighten the nut yet.

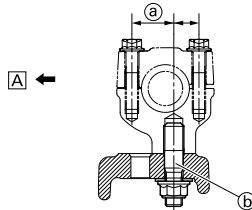
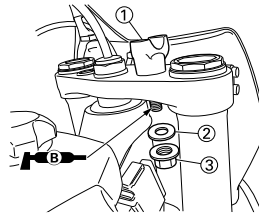

A. Forward

- Install:
 - Handlebar "1"
 - Handlebar upper holder "2"
 - Bolt (handlebar upper holder) "3"



Bolt (handlebar upper holder):
28 Nm (2.8 m•kg, 20 ft•lb)

TIP

- The handlebar upper holder should be installed with the punched mark "a" forward.
- Install the handlebar so that the marks "b" are in place on both sides.
- Install the handlebar so that the projection "c" of the handlebar upper holder is positioned at the mark on the handlebar as shown.
- First tighten the bolts on the front side of the handlebar upper holder, and then tighten the bolts on the rear side.

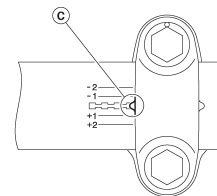
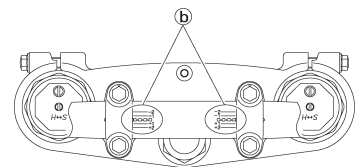
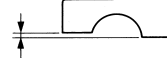
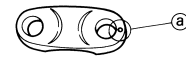
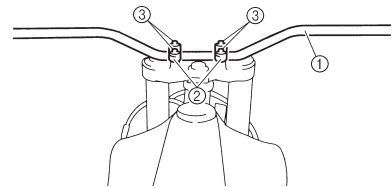

HANDLEBAR

3. Tighten:

- Nut (handlebar lower holder) "1"

	Nut (handlebar lower holder): 34 Nm (3.4 m•kg, 24 ft•lb)
---	---

- Cap "2"

TIP

Install the cap "2" onto the handlebar lower holder nut (left).

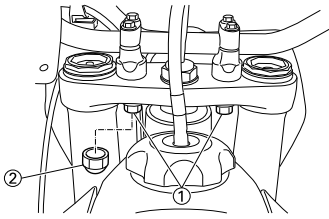

4. Install:

- Left grip "1"
Apply the adhesive to the handlebar "2".

TIP

- Before applying the adhesive, wipe off grease or oil on the handlebar surface "a" with a lacquer thinner.
- Install the left grip to the handlebar so that the line "b" between the two arrow marks faces straight upward.

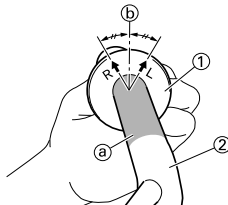

5. Install:

- Right grip "1"
- Collar "2"
Apply the adhesive on the tube guide "3".

TIP

- Before applying the adhesive, wipe off grease or oil on the tube guide surface "a" with a lacquer thinner.
- Install the grip to the tube guide so that the grip match mark "b" and tube guide slot "c" form the angle as shown.

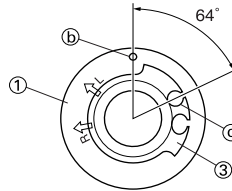
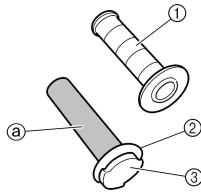

6. Install:

- Collar "1"
- Grip cap cover "2"
- Throttle grip "3"

TIP

Apply the lithium soap base grease on the throttle grip sliding surface.

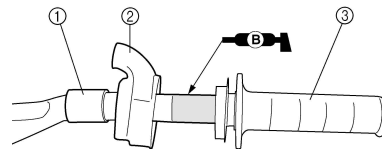

7. Install:

- Throttle cables "1"
To tube guide "2".

TIP

Apply the lithium soap base grease on the throttle cable end and tube guide cable winding portion.

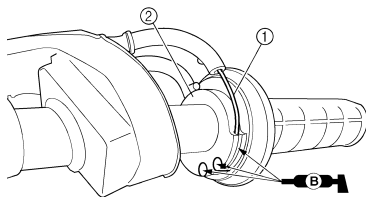

8. Install:

- Throttle cable cap "1"
- Screw (throttle cable cap) "2"



Screw (throttle cable cap): 4 Nm (0.4 m•kg, 2.9 ft•lb)

⚠ WARNING

After tightening the screws, check that the throttle grip "3" moves smoothly. If it does not, retighten the bolts for adjustment.

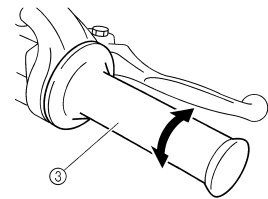
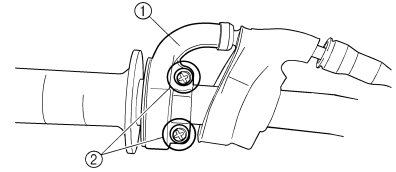

9. Install:

- Grip cap cover "1"
- Cover (throttle cable cap) "2"

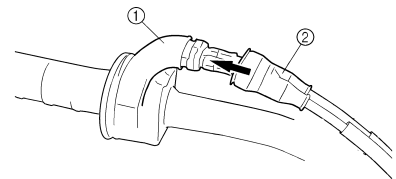

10. Install:

- Brake master cylinder "1"
- Brake master cylinder bracket "2"
- Bolt (brake master cylinder bracket) "3"



Bolt (brake master cylinder bracket): 9 Nm (0.9 m•kg, 6.5 ft•lb)

TIP

- Install the bracket so that the arrow mark "a" faces upward.
- First tighten the bolt on the upper side of the brake master cylinder bracket, and then tighten the bolt on the lower side.

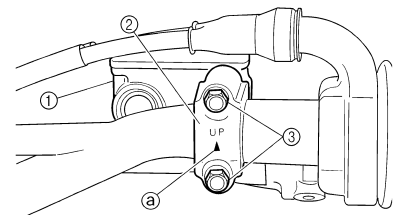

11. Install:

- Engine stop switch "1"
- Clutch lever holder "2"
- Bolt (clutch lever holder) "3"

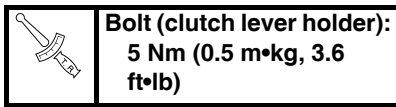

- Clamp "4"

TIP

- The engine stop switch, clutch lever holder and clamp should be installed according to the dimensions shown.
- Pass the engine stop switch lead in the middle of the clutch lever holder.

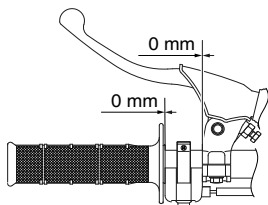
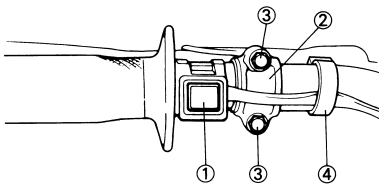

12. Install:

- Clutch cable "1"

TIP

Apply the lithium soap base grease on the clutch cable end.

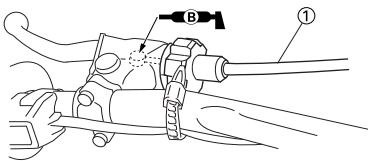

13. Adjust:

- Clutch lever free play
Refer to "ADJUSTING THE CLUTCH CABLE FREE PLAY" section in the CHAPTER 3.

STEERING

REMOVING THE STEERING

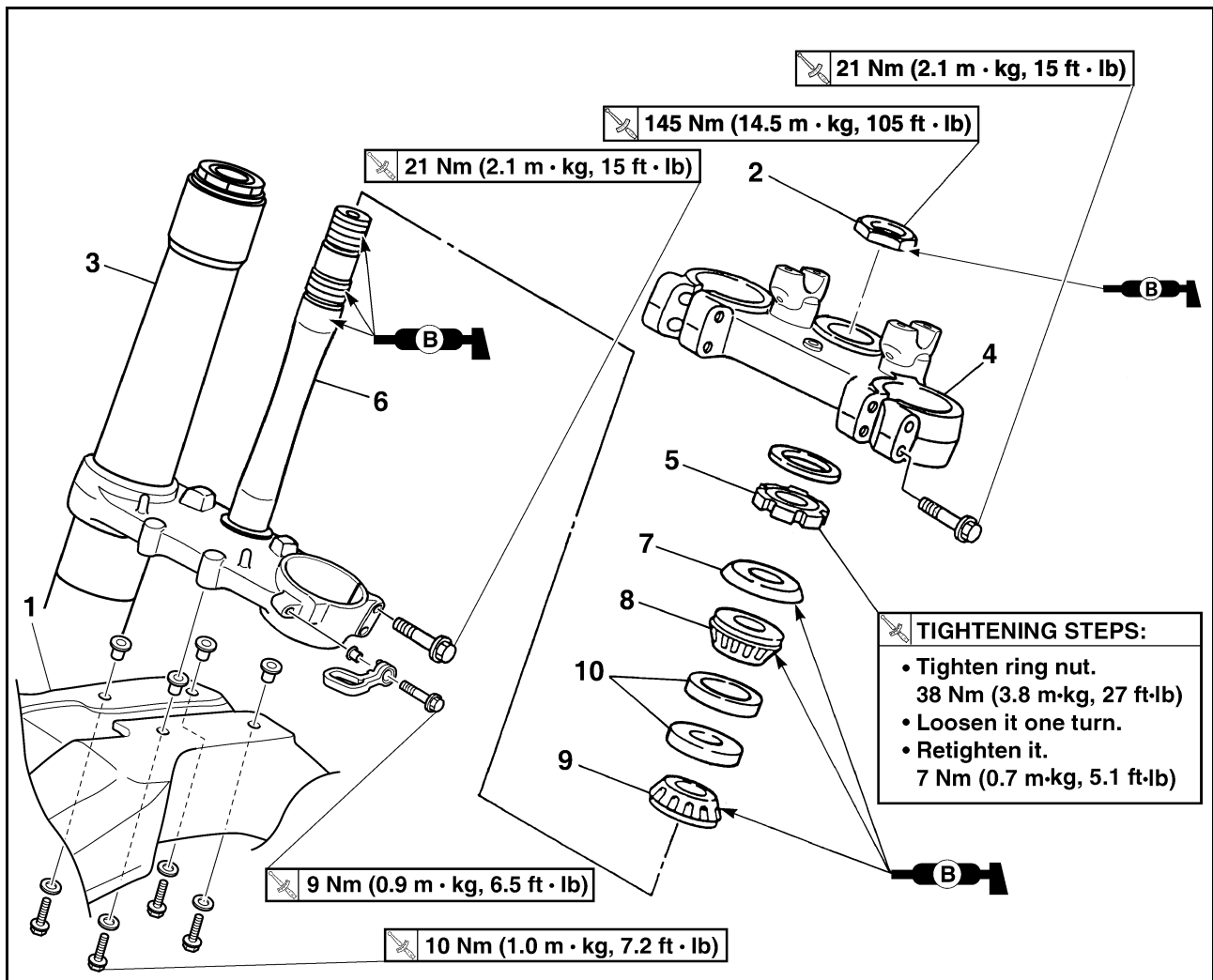

Order	Part name	Q'ty	Remarks
			TIGHTENING STEPS: <ul style="list-style-type: none"> • Tighten ring nut. 38 Nm (3.8 m·kg, 27 ft·lb) • Loosen it one turn. • Retighten it. 7 Nm (0.7 m·kg, 5.1 ft·lb)
	Hold the machine by placing the suitable stand under the engine.		Refer to "HANDLING NOTE".
	Number plate		Refer to "SEAT AND SIDE COVERS" section in the CHAPTER 4.
	Handlebar		Refer to "HANDLEBAR" section.
1	Front fender	1	
2	Steering stem nut	1	
3	Front fork	2	Refer to "FRONT FORK" section.
4	Upper bracket	1	
5	Steering ring nut	1	Refer to removal section.
6	Lower bracket	1	
7	Bearing race cover	1	
8	Upper bearing	1	
9	Lower bearing	1	Refer to removal section.

STEERING

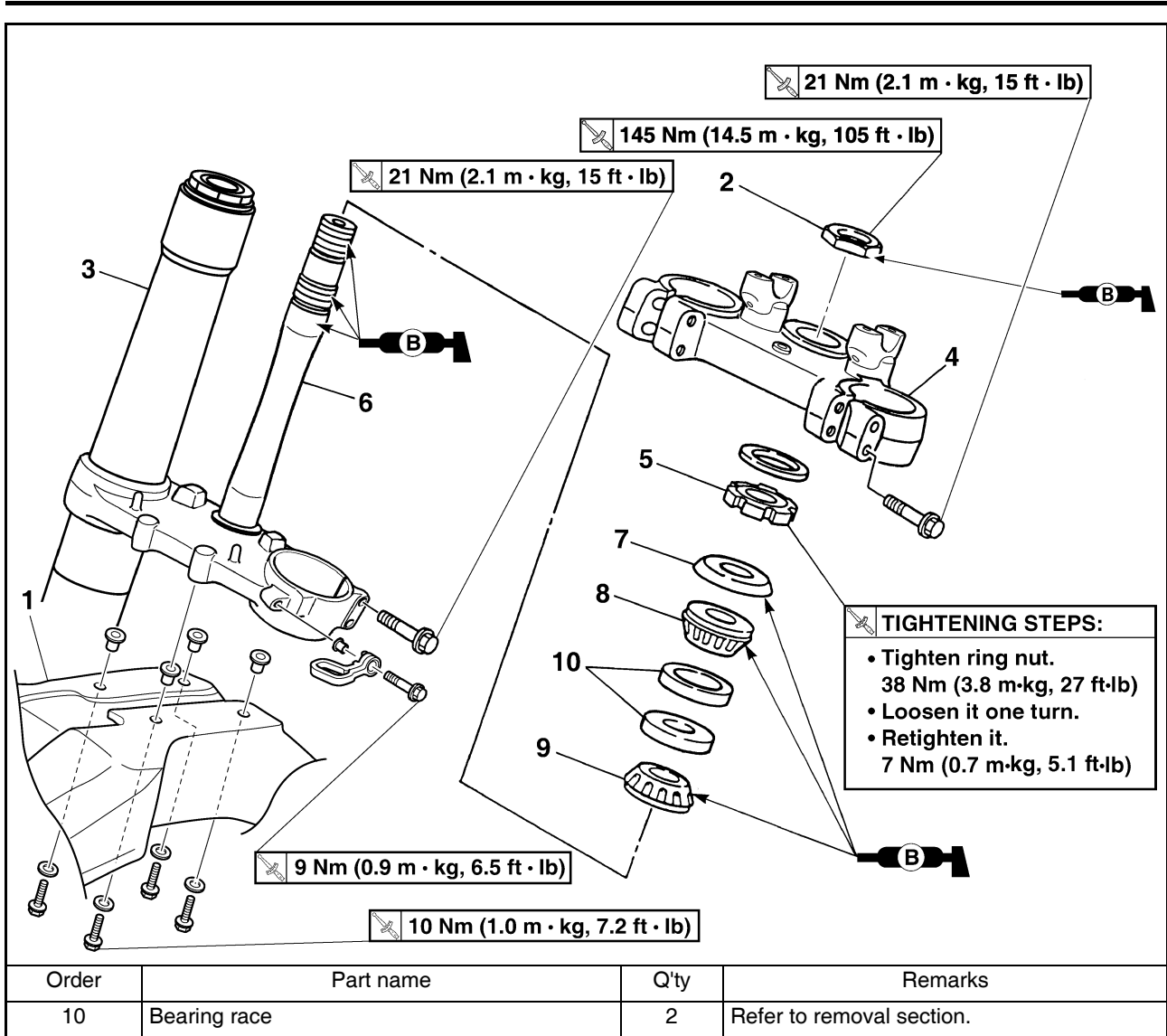

HANDLING NOTE

⚠ WARNING

Support the machine securely so there is no danger of it falling over.

REMOVING THE STEERING RING NUT

- Remove:
 - Steering ring nut "1"
 - Use the steering nut wrench "2".



Steering nut wrench:
YU-33975/90890-01403

⚠ WARNING

Support the steering stem so that it may not fall down.

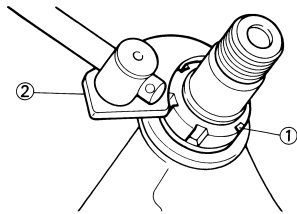

REMOVING THE LOWER BEARING

- Remove:
 - Lower bearing "1"
 - Use the floor chisel "2".

NOTICE

Take care not to damage the steering shaft thread.

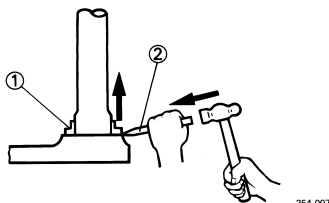

REMOVING THE BEARING RACE

- Remove:
 - Bearing race "1"
 - Remove the bearing race using long rod "2" and the hammer.

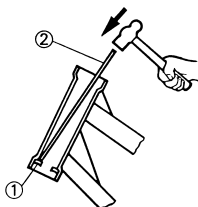

CHECKING THE STEERING STEM

- Inspect:
 - Steering stem "1"
 - Bend/damage → Replace.

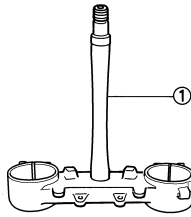

CHECKING THE BEARING AND BEARING RACE

- Wash the bearings and bearing races with a solvent.
- Inspect:
 - Bearing "1"
 - Bearing race
 - Pitting/damage → Replace bearings and bearing races as a set.
 - Install the bearing in the bearing races. Spin the bearings by hand. If the bearings hang up or are not smooth in their operation in the bearing races, replace bearings and bearing races as a set.

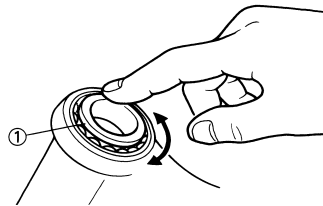

INSTALLING THE LOWER BRACKET

- Install:
 - Lower bearing "1"

TIP

Apply the lithium soap base grease on the dust seal lip and bearing inner circumference.

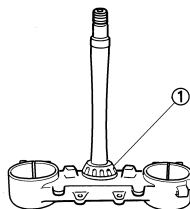

- Install:
 - Bearing race
 - Upper bearing "1"
 - Bearing race cover "2"

TIP

Apply the lithium soap base grease on the bearing and bearing race cover lip.

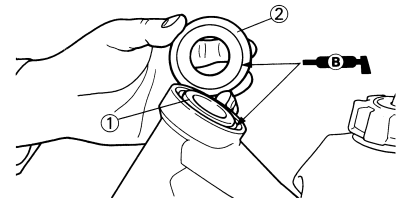

- Install:
 - Lower bracket "1"

TIP

Apply the lithium soap base grease on the bearing, the portion "a" and thread of the steering stem.

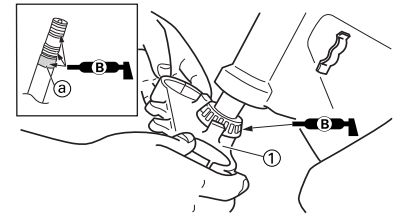

- Install:
 - Steering ring nut "1"



Steering ring nut:
7 Nm (0.7 m•kg, 5.1 ft•lb)

TIP

Install the steering nut with its stepped side "a" facing downward.

Tighten the steering ring nut using the steering nut wrench "2". Refer to "CHECKING AND ADJUSTING THE STEERING HEAD" section in the CHAPTER 3.

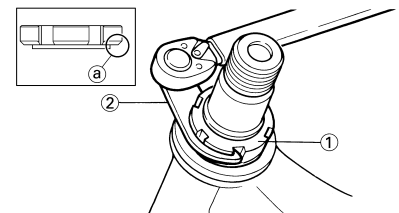

- Check the steering stem by turning it lock to lock. If there is any binding, remove the steering stem assembly and inspect the steering bearings.

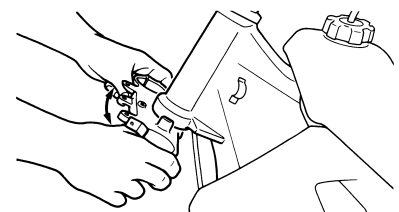

6. Install:

- Washer "1"

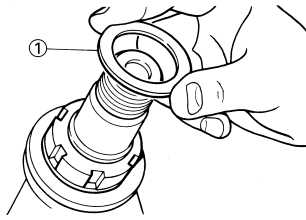

7. Install:

- Front fork "1"
- Upper bracket "2"

TIP

- Temporarily tighten the pinch bolts (lower bracket).
- Do not tighten the pinch bolts (upper bracket) yet.

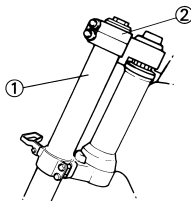

8. Install:

- Steering stem nut "1"



Steering stem nut:
145 Nm (14.5 m•kg, 105 ft•lb)

TIP

Apply the lithium soap base grease on the contact surface of the steering stem nut when installing.

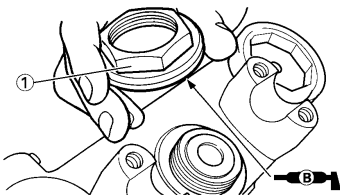

9. After tightening the nut, check the steering for smooth movement. If not, adjust the steering by loosening the steering ring nut little by little.

10. Adjust:

- Front fork top end "a"



Front fork top end (standard) "a":
Zero mm (Zero in)

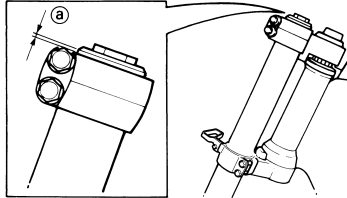

11. Tighten:

- Pinch bolt (upper bracket) "1"



Pinch bolt (upper bracket):
21 Nm (2.1 m•kg, 15 ft•lb)

- Pinch bolt (lower bracket) "2"



Pinch bolt (lower bracket):
21 Nm (2.1 m•kg, 15 ft•lb)

⚠ WARNING

Tighten the lower bracket to specified torque. If torqued too much, it may cause the front fork to malfunction.

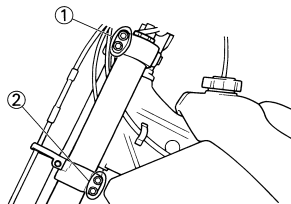

SWINGARM

REMOVING THE SWINGARM

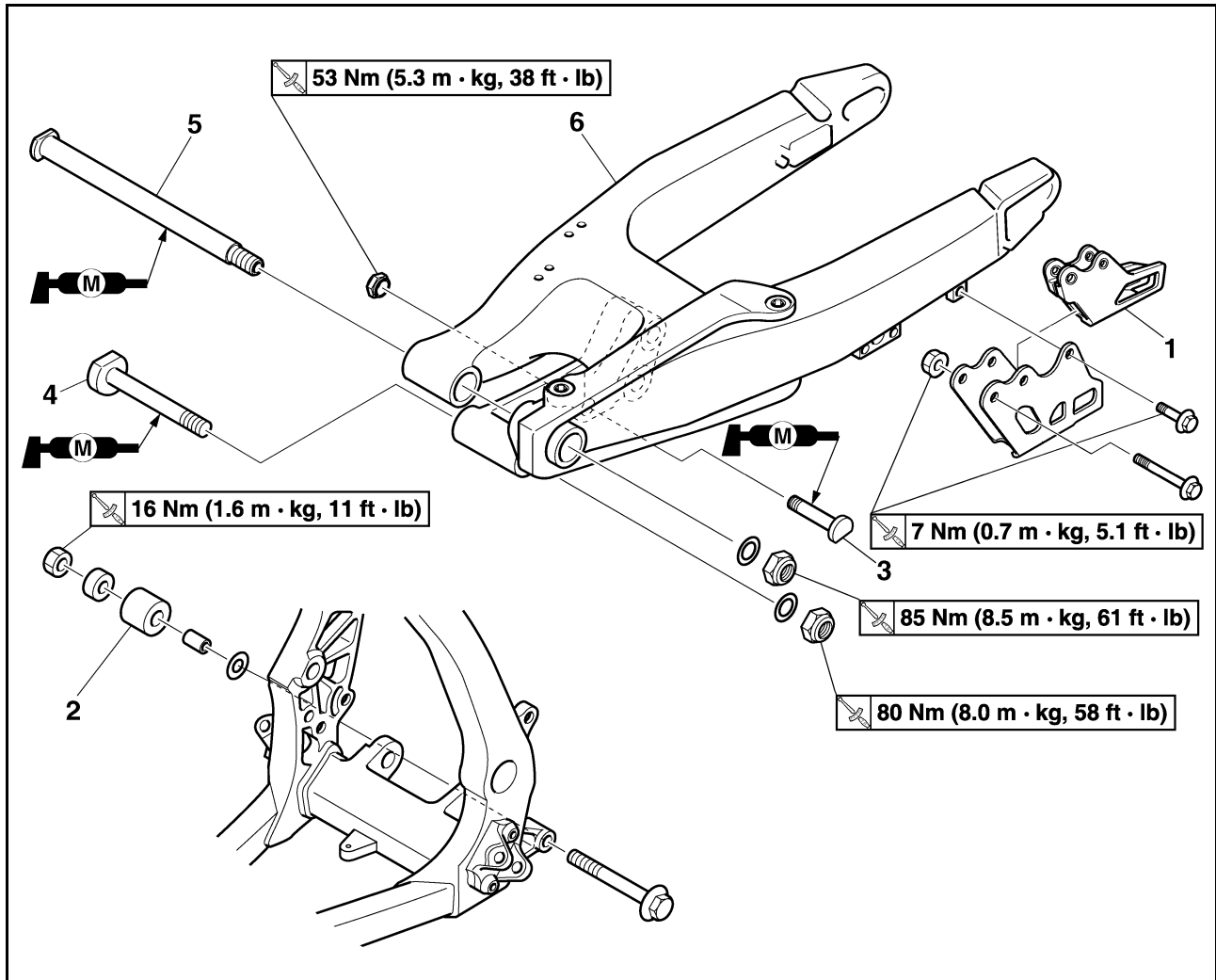

Order	Part name	Q'ty	Remarks
	Hold the machine by placing the suitable stand under the engine.		Refer to "HANDLING NOTE".
	Brake hose holder		Refer to "FRONT BRAKE AND REAR BRAKE" section.
	Rear brake caliper		Refer to "FRONT BRAKE AND REAR BRAKE" section.
	Bolt (brake pedal)		Shift the brake pedal backward.
	Drive chain		
1	Drive chain support	1	
2	Lower chain tensioner	1	
3	Bolt (rear shock absorber-relay arm)	1	Hold the swingarm.
4	Bolt (connecting rod)	1	
5	Pivot shaft	1	
6	Swingarm	1	

DISASSEMBLING THE SWINGARM

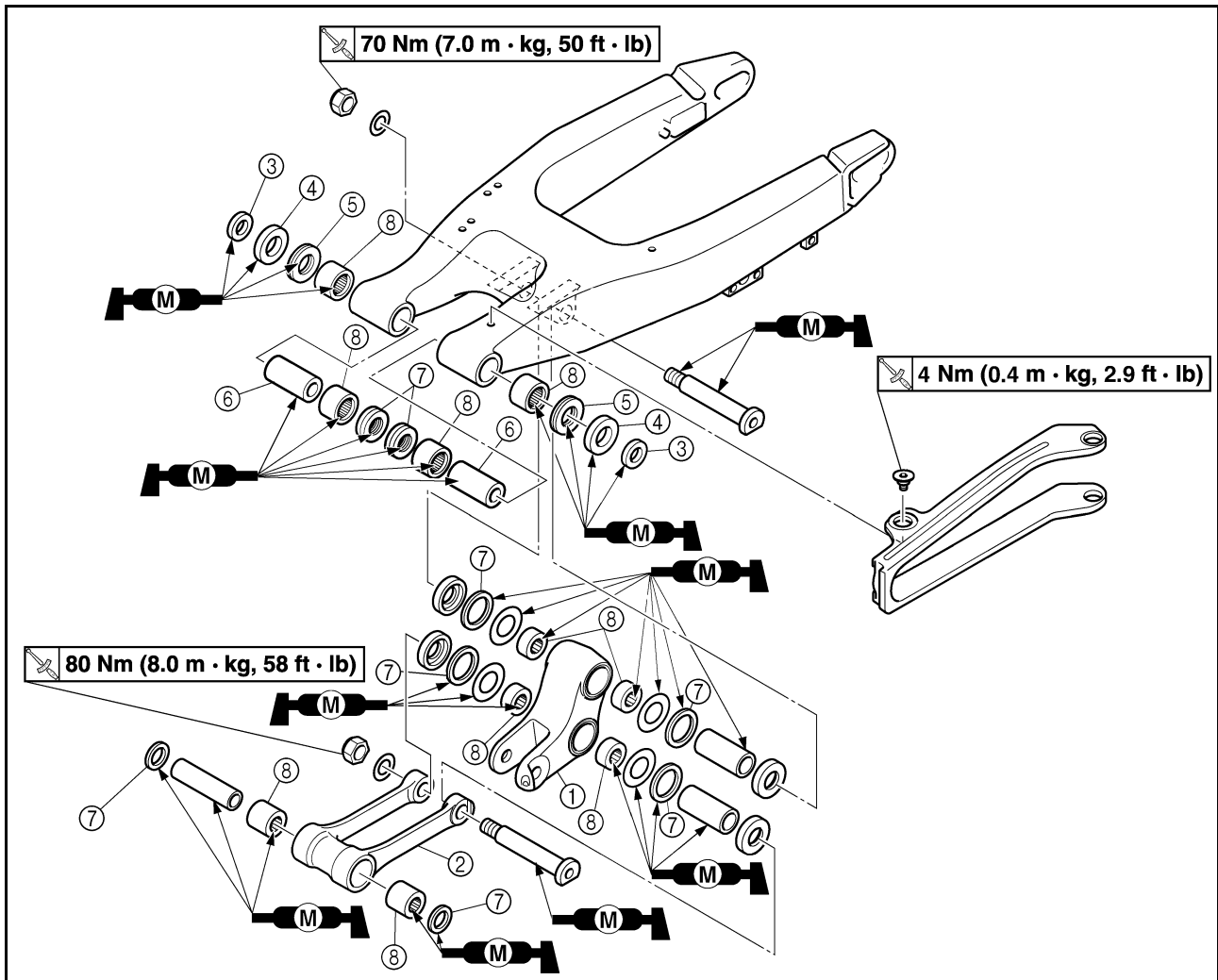

Order	Part name	Q'ty	Remarks
1	Relay arm	1	
2	Connecting rod	1	
3	Collar	2	
4	Oil seal	2	
5	Thrust bearing	2	
6	Bushing	2	
7	Oil seal	8	
8	Bearing	10	Refer to removal section.

HANDLING NOTE

⚠ WARNING

Support the machine securely so there is no danger of it falling over.

REMOVING THE BEARING

- Remove:
 - Bearing "1"

TIP

Remove the bearing by pressing its outer race.

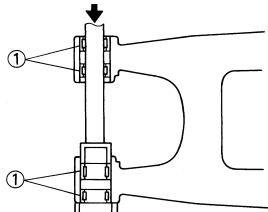

CHECKING THE SWINGARM

- Inspect:
 - Bearing "1"
 - Bushing "2"

Free play exists/unsmooth revolution/rust → Replace bearing and bushing as a set.
- Inspect:
 - Oil seal "3"

Damage → Replace.

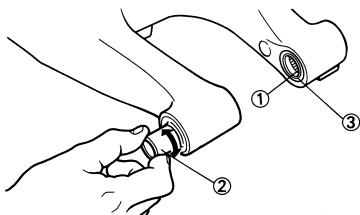

CHECKING THE RELAY ARM

- Inspect:
 - Bearing "1"
 - Collar "2"

Free play exists/unsmooth revolution/rust → Replace bearing and collar as a set.
- Inspect:
 - Oil seal "3"

Damage → Replace.

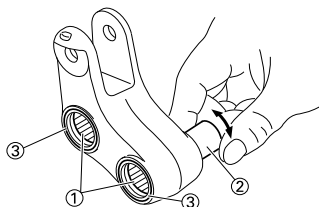

CHECKING THE CONNECTING ROD

- Inspect:
 - Bearing "1"
 - Collar "2"

Free play exists/unsmooth revolution/rust → Replace bearing and collar as a set.
- Inspect:
 - Oil seal "3"

Damage → Replace.

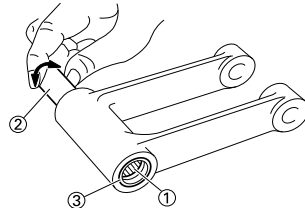

INSTALLING THE BEARING AND OIL SEAL

- Install:
 - Bearing "1"
 - Oil seal "2"

To swingarm.
- TIP**
- Apply the molybdenum disulfide grease on the bearing when installing.
 - Install the bearing by pressing it on the side having the manufacturer's marks or numbers.
 - First install the outer and then the inner bearings to a specified depth from inside.

	Installed depth of bearings:
	Outer "a": Zero mm (Zero in)
	Inner "b": 6.5 mm (0.26 in)

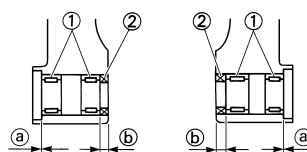
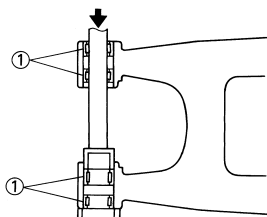

- Install:
 - Bearing "1"
 - Washer "2"
 - Oil seal "3"

To relay arm.

TIP

- Apply the molybdenum disulfide grease on the bearing when installing.
- Install the bearing by pressing it on the side having the manufacturer's marks or numbers.
- Apply the molybdenum disulfide grease on the washer.

	Installed depth of bearings "a":
	Zero mm (Zero in)

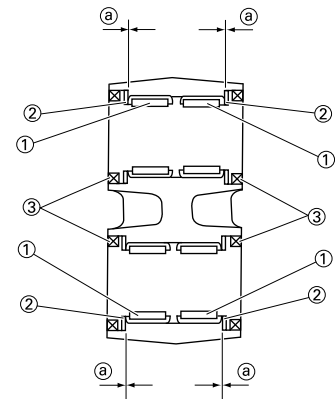

- Install:
 - Bearing "1"
 - Oil seal "2"

To connecting rod.

TIP

- Apply the molybdenum disulfide grease on the bearing when installing.
- Install the bearing by pressing it on the side having the manufacturer's marks or numbers.

	Installed depth of bearings "a":
	Zero mm (Zero in)

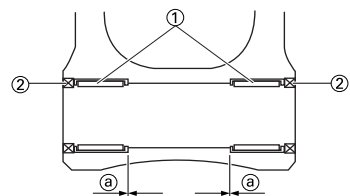

INSTALLING THE SWINGARM

1. Install:
 - Bushing "1"
 - Thrust bearing "2"
 - Oil seal "3"
 - Collar "4"
 To swingarm "5".

TIP

Apply the molybdenum disulfide grease on the bushings, thrust bearings, oil seal lips and contact surfaces of the collar and thrust bearing.

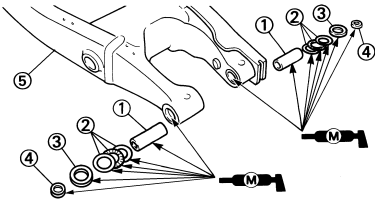

2. Install:
 - Collar "1"
 - Washer "2"
 To relay arm "3".

TIP

Apply the molybdenum disulfide grease on the collars and oil seal lips.

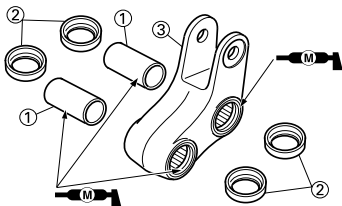

3. Install:
 - Collar "1"
 To connecting rod "2".

TIP

Apply the molybdenum disulfide grease on the collar and oil seal lips.

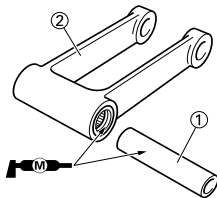

4. Install:
 - Connecting rod "1"
 - Bolt (connecting rod) "2"
 - Washer "3"
 - Nut (connecting rod) "4"



To relay arm "5".

TIP

Apply the molybdenum disulfide grease on the bolt.

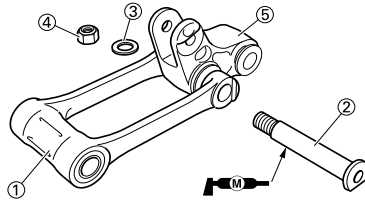

5. Install:
 - Relay arm "1"
 - Bolt (relay arm) "2"
 - Washer "3"
 - Nut (relay arm) "4"
 To swingarm.

TIP

- Apply the molybdenum disulfide grease on the bolt circumference and threaded portion.
- Do not tighten the nut yet.

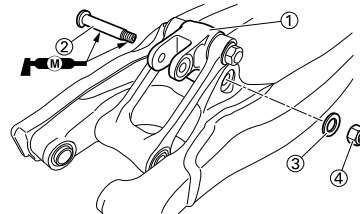

6. Install:
 - Swingarm "1"
 - Pivot shaft "2"

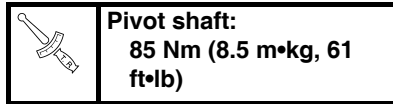

TIP

- Apply the molybdenum disulfide grease on the pivot shaft.
- Insert the pivot shaft from right side.

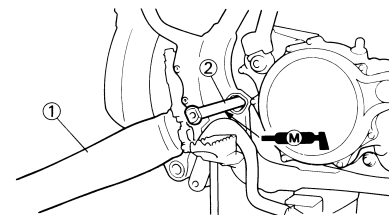

7. Check:
 - Swingarm side play "a"
 - Free play exists → Replace thrust bearing.
 - Swingarm up and down movement "b"
 - Unsmooth movement/binding/rough spots → Grease or replace bearings, bushings and collars.

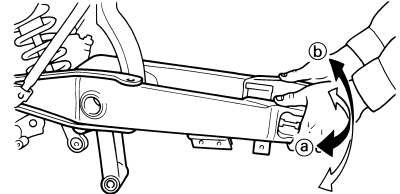

8. Install:
 - Bolt (connecting rod) "1"
 - Washer "2"
 - Nut (connecting rod) "3"

TIP

- Apply the molybdenum disulfide grease on the bolt.
- Do not tighten the nut yet.

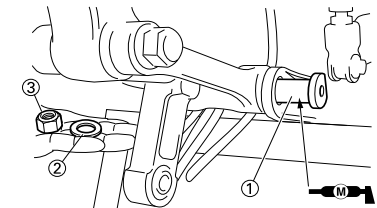

9. Install:
 - Bolt (rear shock absorber-relay arm) "1"
 - Nut (rear shock absorber-relay arm) "2"

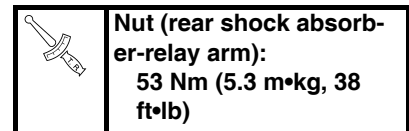

TIP

Apply the molybdenum disulfide grease on the bolt.

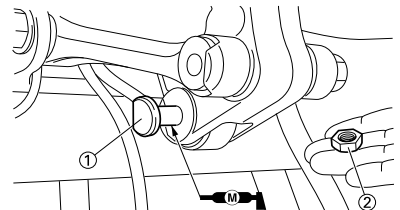

10. Tighten:

- Nut (connecting rod) "1"

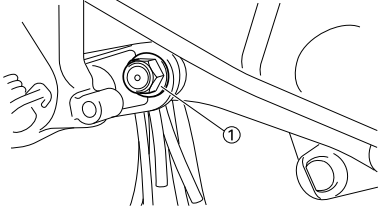
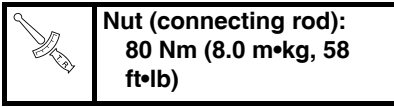

11. Tighten:

- Nut (relay arm) "1"

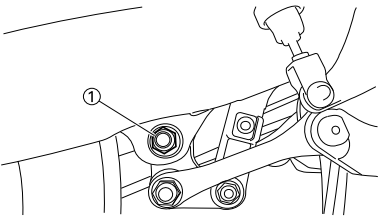
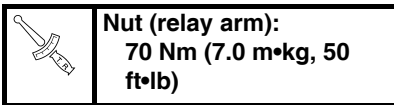

12. Install:

- Bolt (lower chain tensioner) "1"
- Washer "2"
- Collar "3"
- Lower chain tensioner "4"
- Nut (lower chain tensioner) "5"

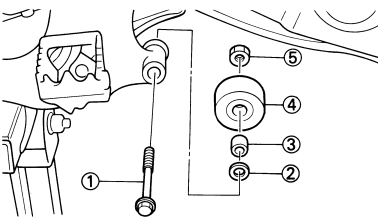
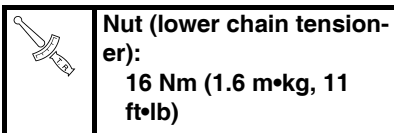

13. Install:

- Drive chain support "1"
- Drive chain support cover "2"
- Bolt (drive chain support [L = 50 mm (1.97 in)]) "3"
- Nut (drive chain support) "4"

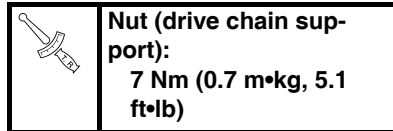

- Bolt (drive chain support cover [L = 10 mm (0.39 in)]) "5"

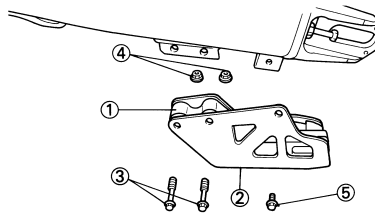
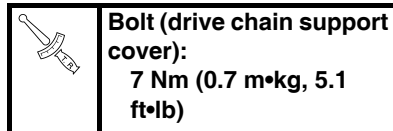

REAR SHOCK ABSORBER

REAR SHOCK ABSORBER

REMOVING THE REAR SHOCK ABSORBER

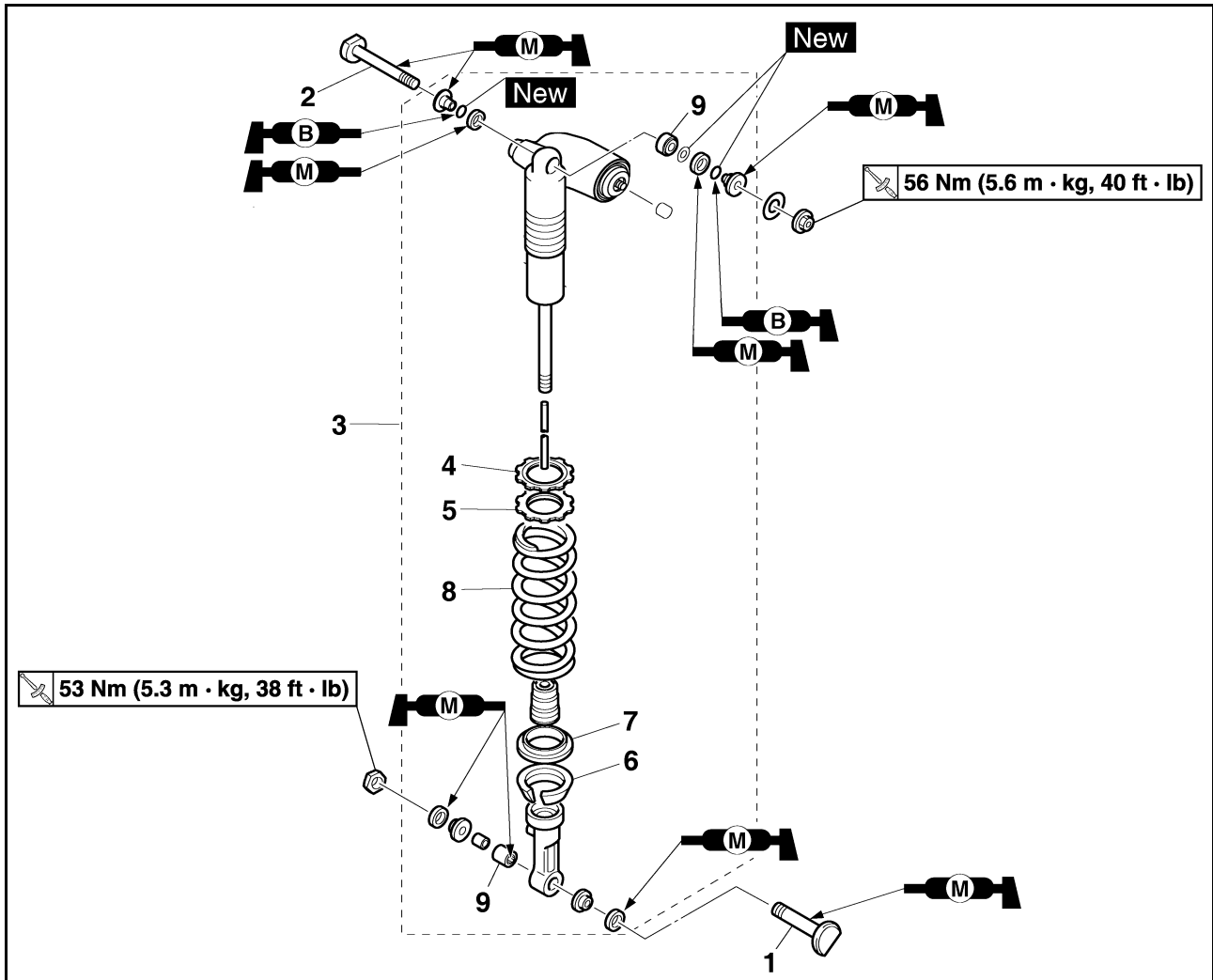

Order	Part name	Q'ty	Remarks
	Hold the machine by placing the suitable stand under the engine.		Refer to "HANDLING NOTE".
	Seat		Refer to "SEAT AND SIDE COVERS" section in the CHAPTER 4.
	Silencer		Refer to "EXHAUST PIPE AND SILENCER" section in the CHAPTER 4.
1	Bolt (rear shock absorber-relay arm)	1	Hold the swingarm.
2	Bolt (rear shock absorber-frame)	1	
3	Rear shock absorber	1	
4	Locknut	1	Only loosening.
5	Adjuster	1	Only loosening.
6	Lower spring guide	1	
7	Upper spring guide	1	
8	Spring (rear shock absorber)	1	
9	Bearing	2	Refer to removal section.

REAR SHOCK ABSORBER

HANDLING NOTE

⚠ WARNING

- Support the machine securely so there is no danger of it falling over.
- This rear shock absorber is provided with a separate type tank filled with high-pressure nitrogen gas. To prevent the danger of explosion, read and understand the following information before handling the shock absorber. The manufacturer can not be held responsible for property damage or personal injury that may result from improper handling.
- Never tamper or attempt to disassemble the cylinder or the tank.
- Never throw the rear shock absorber into an open flame or other high heat. The rear shock absorber may explode as a result of nitrogen gas expansion and/ or damage to the hose.
- Be careful not to damage any part of the gas tank. A damaged gas tank will impair the damping performance or cause a malfunction.
- Take care not to scratch the contact surface of the piston rod with the cylinder; or oil could leak out.
- Never attempt to remove the plug at the bottom of the nitrogen gas tank. It is very dangerous to remove the plug.
- When scrapping the rear shock absorber, follow the instructions on disposal.

NOTES ON DISPOSAL (YAMAHA DEALERS ONLY)

Before disposing the rear shock absorber, be sure to extract the nitrogen gas from valve "1". Wear eye protection to prevent eye damage from escaping gas and/or metal chips.

⚠ WARNING

To dispose of a damaged or worn-out rear shock absorber, take the unit to your Yamaha dealer for this disposal procedure.

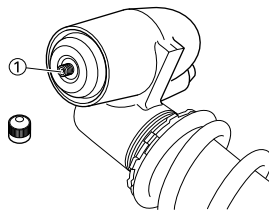

REMOVING THE BEARING

1. Remove:
 - Stopper ring (upper bearing) "1"

TIP
Press in the bearing while pressing its outer race and remove the stopper ring.

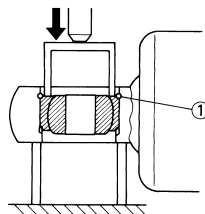

2. Remove:
 - Upper bearing "1"

TIP
Remove the bearing by pressing its outer race.

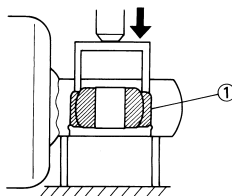

3. Remove:
 - Lower bearing "1"

TIP
Remove the bearing by pressing its outer race.

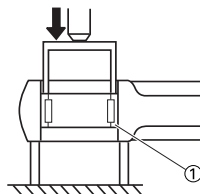

CHECKING THE REAR SHOCK ABSORBER

1. Inspect:
 - Damper rod "1"
Bends/damage → Replace rear shock absorber assembly.
 - Shock absorber "2"
Oil leaks → Replace rear shock absorber assembly.
Gas leaks → Replace rear shock absorber assembly.
 - Spring "3"
Damage → Replace spring.
Fatigue → Replace spring.
Move spring up and down.
 - Spring guide "4"
Wear/damage → Replace spring guide.
 - Bearing "5"
Free play exists/unsmooth revolution/rust → Replace.

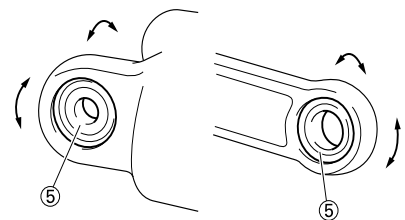
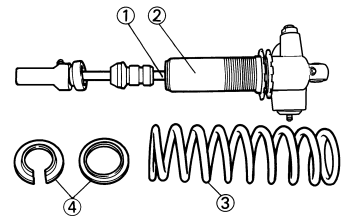

INSTALLING THE BEARING

1. Install:
 - Upper bearing "1"

TIP
Install the bearing parallel until the stopper ring groove appears by pressing its outer race.

NOTICE

Do not apply the grease on the bearing outer race because it will wear the rear shock absorber surface on which the bearing is press fitted.

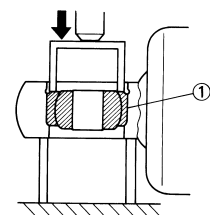

REAR SHOCK ABSORBER

2. Install:
- Stopper ring (upper bearing) "1"
New

TIP

After installing the stopper ring, push back the bearing until it contacts the stopper ring.

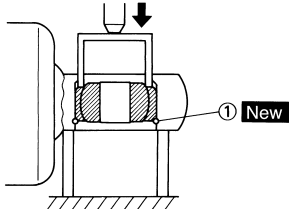

3. Install:
- Lower bearing "1"

TIP

Install the bearing by pressing it on the side having the manufacture's marks or numbers.

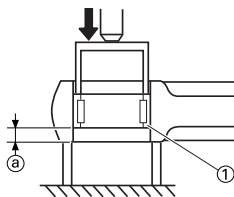
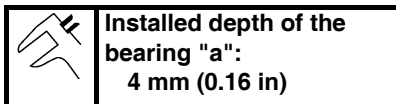

INSTALLING THE SPRING (REAR SHOCK ABSORBER)

1. Install:
- Spring "1"
 - Upper spring guide "2"
 - Lower spring guide "3"

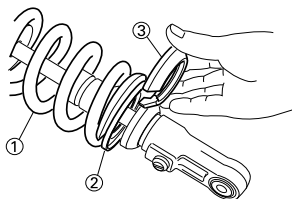

2. Tighten:
- Adjuster "1"

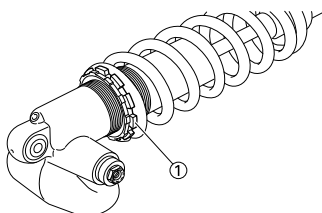

3. Adjust:
- Spring length (installed)
Refer to "ADJUSTING THE REAR SHOCK ABSORBER SPRING PRELOAD" section in the CHAPTER 3.

4. Tighten:
- Locknut "1"

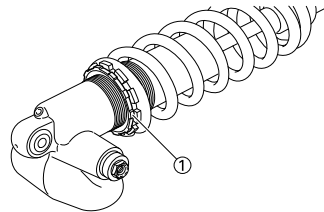

INSTALLING THE REAR SHOCK ABSORBER

1. Install:
- Dust seal "1"
 - O-ring "2" **New**
 - Collar "3"

TIP

- Apply the molybdenum disulfide grease on the dust seal lips and collars.
- Apply the lithium soap base grease on the O-rings.

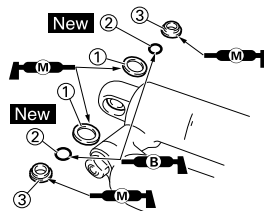

2. Install:
- Bushing "1"
 - Collar "2"
 - Dust seal "3"

TIP

- Apply the molybdenum disulfide grease on the bearing and dust seal lips.
- Install the dust seals with their lips facing inward.

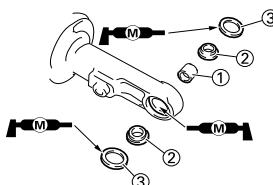

3. Install:
- Rear shock absorber

4. Install:
- Bolt (rear shock absorber-frame) "1"
 - Washer "2"
 - Nut (rear shock absorber-frame) "3"

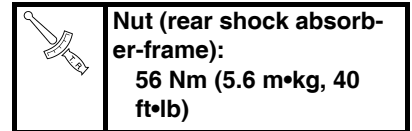

TIP

Apply the molybdenum disulfide grease on the bolt.

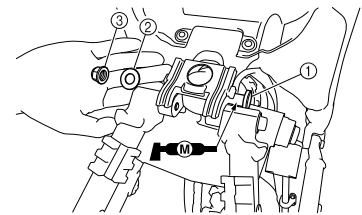

5. Install:
- Bolt (rear shock absorber-relay arm) "1"
 - Nut (rear shock absorber-relay arm) "2"

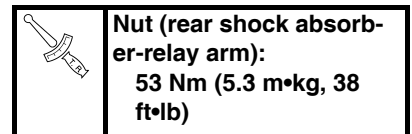

TIP

Apply the molybdenum disulfide grease on the bolt.

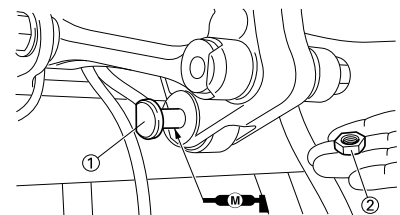

FUEL SYSTEM

TIP

This section is intended for those who have basic knowledge and skill concerning the servicing of Yamaha motorcycles (e.g., Yamaha dealers, service engineers, etc.) Those who have little knowledge and skill concerning servicing are requested not to undertake inspection, adjustment, disassembly, or reassembly only by reference to this manual. It may lead to servicing trouble and mechanical damage.

FUEL TANK

REMOVING THE FUEL TANK

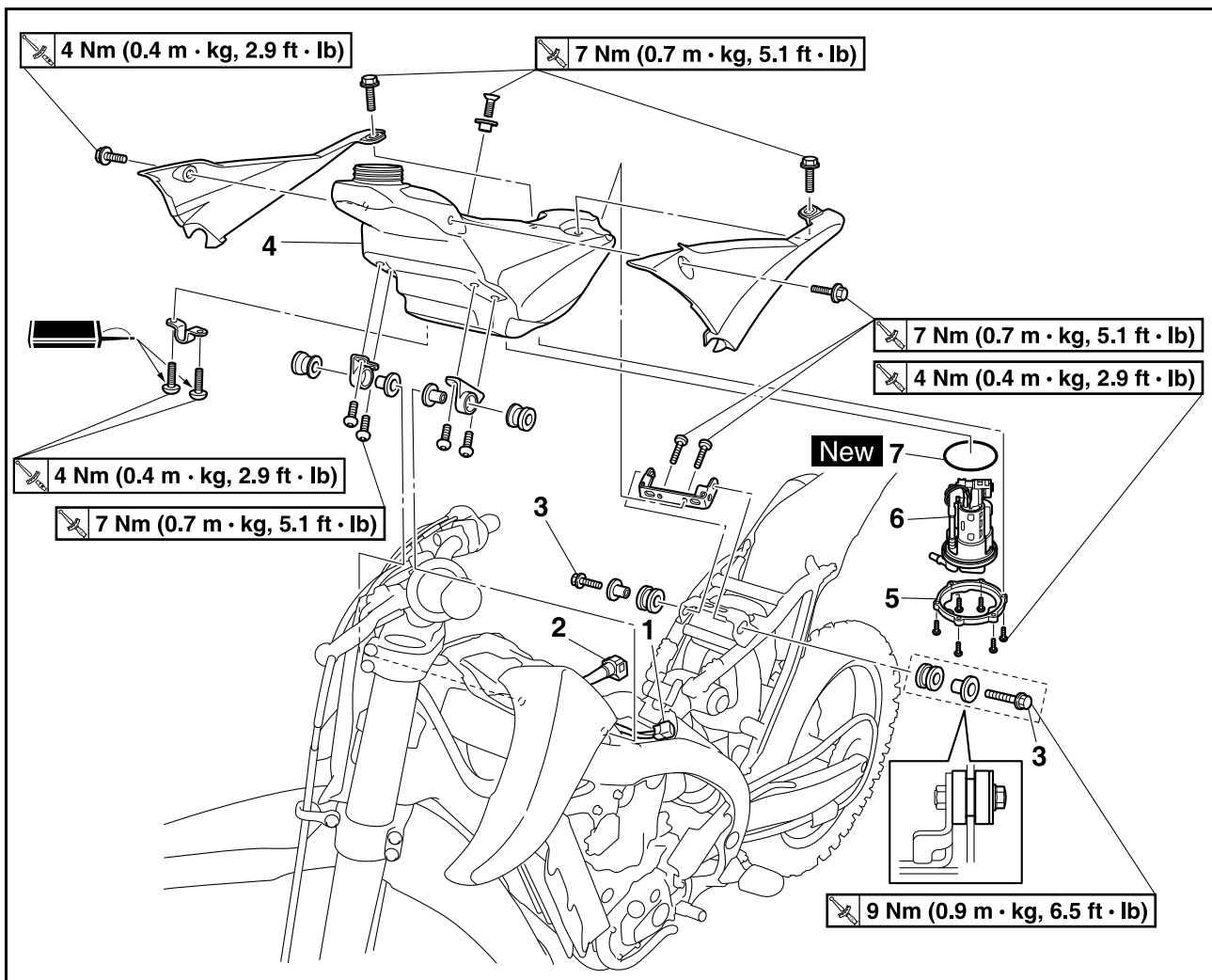

Order	Part name	Q'ty	Remarks
	Seat		Refer to "SEAT AND SIDE COVERS" section in the chapter 4.
	Air scoop (left/right)	1/1	Refer to "SEAT AND SIDE COVERS" section in the chapter 4.
1	Fuel pump coupler	1	Disconnect.
2	Fuel hose	1	Refer to removal section.
3	Fuel tank bolt	2	
4	Fuel tank	1	Refer to removal section.
5	Fuel pump bracket	1	
6	Fuel pump assembly	1	Refer to removal section.
7	O-ring	1	

REMOVING THE FUEL TANK

1. Extract the fuel in the fuel tank through the fuel tank cap with a pump.

NOTICE

Be careful not to damage the fuel pump.

2. Remove:
 - Fuel pump coupler

NOTICE

Although the fuel has been removed from the fuel tank be careful when removing the fuel hoses, since there may be fuel remaining in it.

TIP

- Before disconnecting the fuel hose, clean the area around the fuel hose connector.
- Before removing the fuel hose, place a few rags in the area under where it will be removed.
- To disconnect the fuel hose from the fuel tank, remove the fuel hose connector holder "a", and then slide the fuel hose connector cover.
- Slide the fuel hose connector cover "1" in the direction of the arrow mark, and press the buttons "2" on both sides of the connector to remove the fuel hose.
- Disconnecting the hose is done by hand. There is no need to use tools.
- To prevent sand, dust, and other foreign material from entering the fuel pump, install the included fuel hose joint cover 1 "3" and fuel hose joint cover 2 "4" onto the fuel pump and disconnected fuel hose.

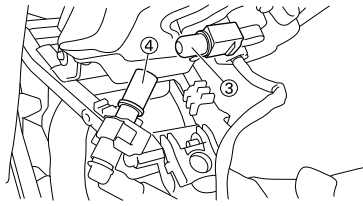
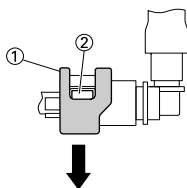
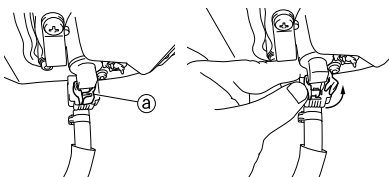

3. Remove:
 - Fuel tank

TIP

Do not set the fuel tank down so that the installation surface of the fuel pump is directly under the tank.

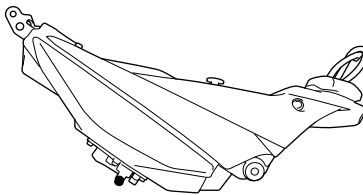

REMOVING THE FUEL PUMP

1. Remove:
 - Fuel pump

NOTICE

Do not drop the fuel pump or give it a strong shock.

CHECKING THE FUEL PUMP BODY

1. Check:
 - Fuel pump body
Cracks/damage → Replace fuel pump assembly.

CHECKING THE FUEL PUMP OPERATION

1. Check:
 - Fuel pump operation
Refer to "CHECKING THE FUEL PRESSURE" section.

INSTALLING THE FUEL PUMP

1. Install:
 - Fuel pump
 - Fuel pump bracket

NOTICE

- Do not damage the installation surfaces of the fuel tank when installing the fuel pump.
- Before installing the fuel pump, remove any dirt and other foreign material from the installation surface on the fuel tank.



Fuel pump bracket bolt
4 Nm (0.4 m•kg, 2.9 ft•lb)

TIP

- Always use a new fuel pump gasket.
- Install the lip on the fuel pump gasket upward.
- Install the fuel pump as shown in the illustration.
- Align the projection "a" on the fuel pump with the slot in the fuel pump bracket. Align the slot "b" on the fuel tank damper with the projection "a" on the fuel pump.
- Tighten the fuel pump bolts in stages in a crisscross pattern.

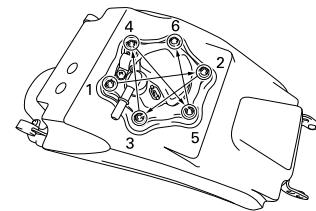
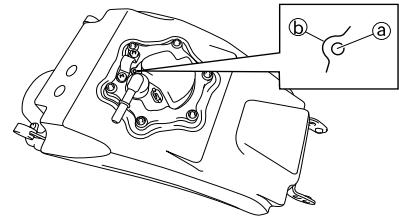

INSTALLING THE FUEL TANK

1. Install:
 - Fuel hose

NOTICE

- When installing the fuel hose, make sure that it is securely connected, and that the fuel hose holders are in the correct position, otherwise the fuel hose will not be properly installed.
- Be sure not to kink or pinch the fuel hose.

TIP

- Insert the fuel hose on the fuel pipe until you hear a definite "click".
- Slide the fuel hose connector cover "1" at the fuel hose end in the direction of the arrow.
- Install the fuel hose connector holder "a".
- Make sure that the fuel hose and fuel pump lead are routed through the guide on the cover.

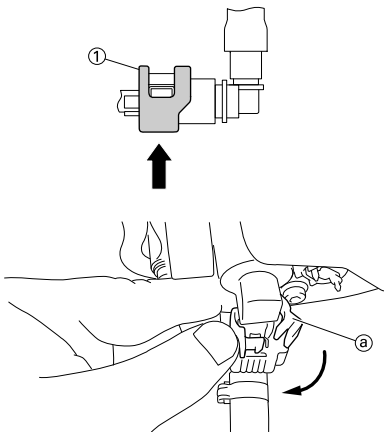

CHECKING AND REPLACING THE DUMPER

1. Inspect:

- Damper 1 "1"
- Damper 2 "2"
- Damper 3 "3"

Wear/damage → Replace

TIP

- Affix dampers 1 and 3 so that the arrow on each damper is pointing outward.
- Affix damper 2 so that the edge of the damper contacts the edge "a" of the frame.

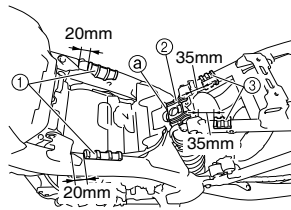

2. Install:

- Fuel pump coupler
- Air scoop (left/right)
- Seat

Refer to "SEAT AND SIDE COVERS" in the chapter 4.

CHECKING THE FUEL PRESSURE

1. Check:

- Pressure regulator operation

2. Remove the fuel tank.

Refer to "REMOVEING THE FUEL TANK" section.

3. Connect the pressure gauge "1" and adapter "2" to the fuel injection pipe.

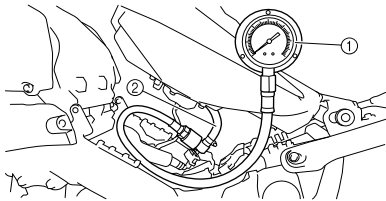

	Pressure gauge YU-03153/90890-03153 Fuel pressure adapter YM-03186/90890-03186
---	---

4. Install the fuel tank.

Refer to "INSTALLING THE FUEL TANK" section.

5. Start the engine.

6. Measure the fuel pressure.

	Fuel pressure 312–328 kPa (3.12–3.28 kg/cm²)
---	--

THROTTLE BODY

THROTTLE BODY

REMOVING THE THROTTLE BODY

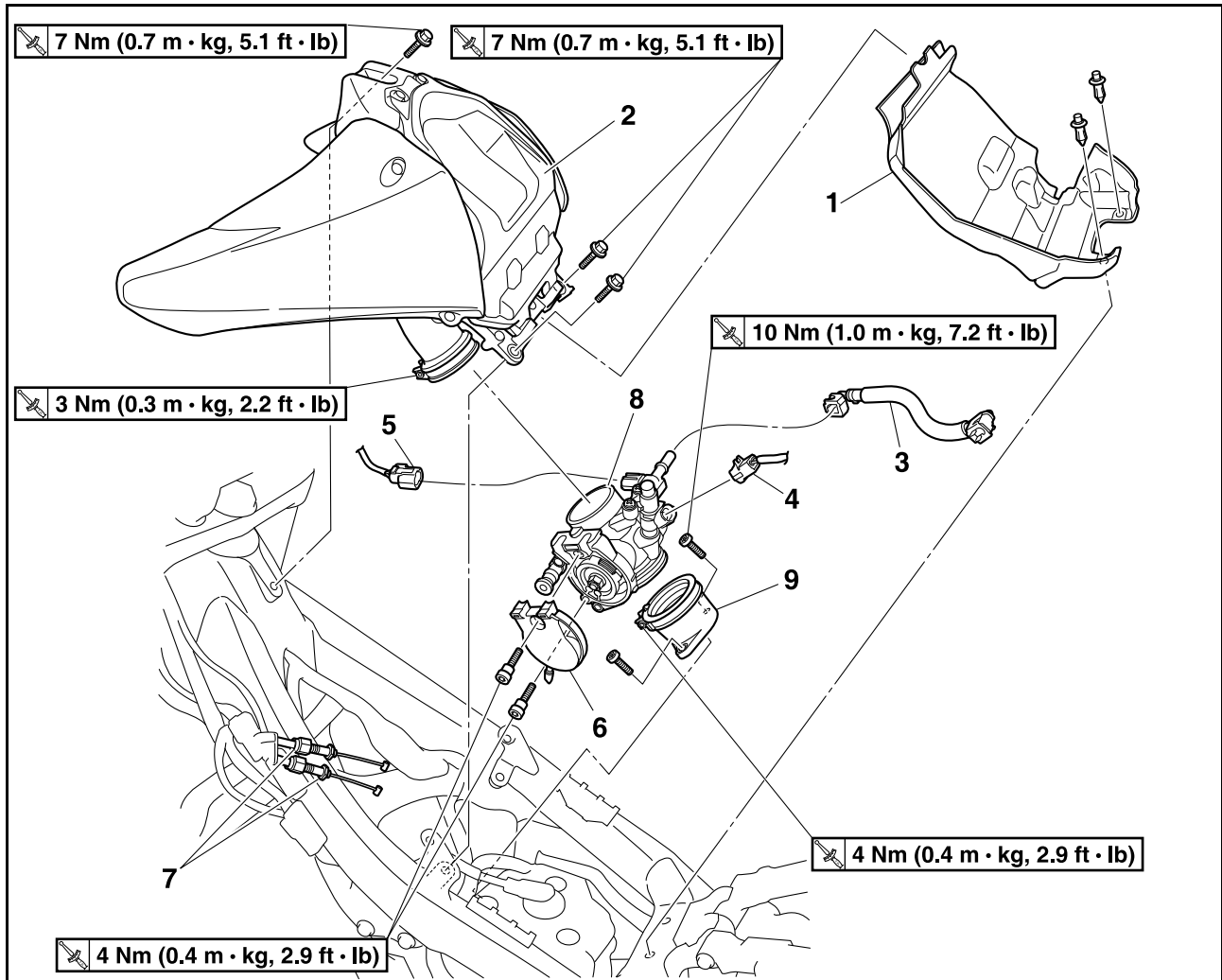

Order	Part name	Q'ty	Remarks
	Seat		Refer to "SEAT AND SIDE COVERS" section in the chapter 4.
	Air scoop (left/right)		Refer to "SEAT AND SIDE COVERS" section in the chapter 4.
	Fuel tank		Refer to "FUEL TANK" section.
1	Cover	1	
2	Air filter case	1	
3	Fuel hose	1	
4	Fuel injector coupler	1	Disconnect.
5	Intake air pressure sensor coupler	1	Disconnect. (I.D. MARK "2")
6	Throttle cable cover	1	
7	Throttle cable	2	
8	Throttle body	1	
9	Throttle body joint	1	

THROTTLE BODY

DISASSEMBLING THE THROTTLE BODY

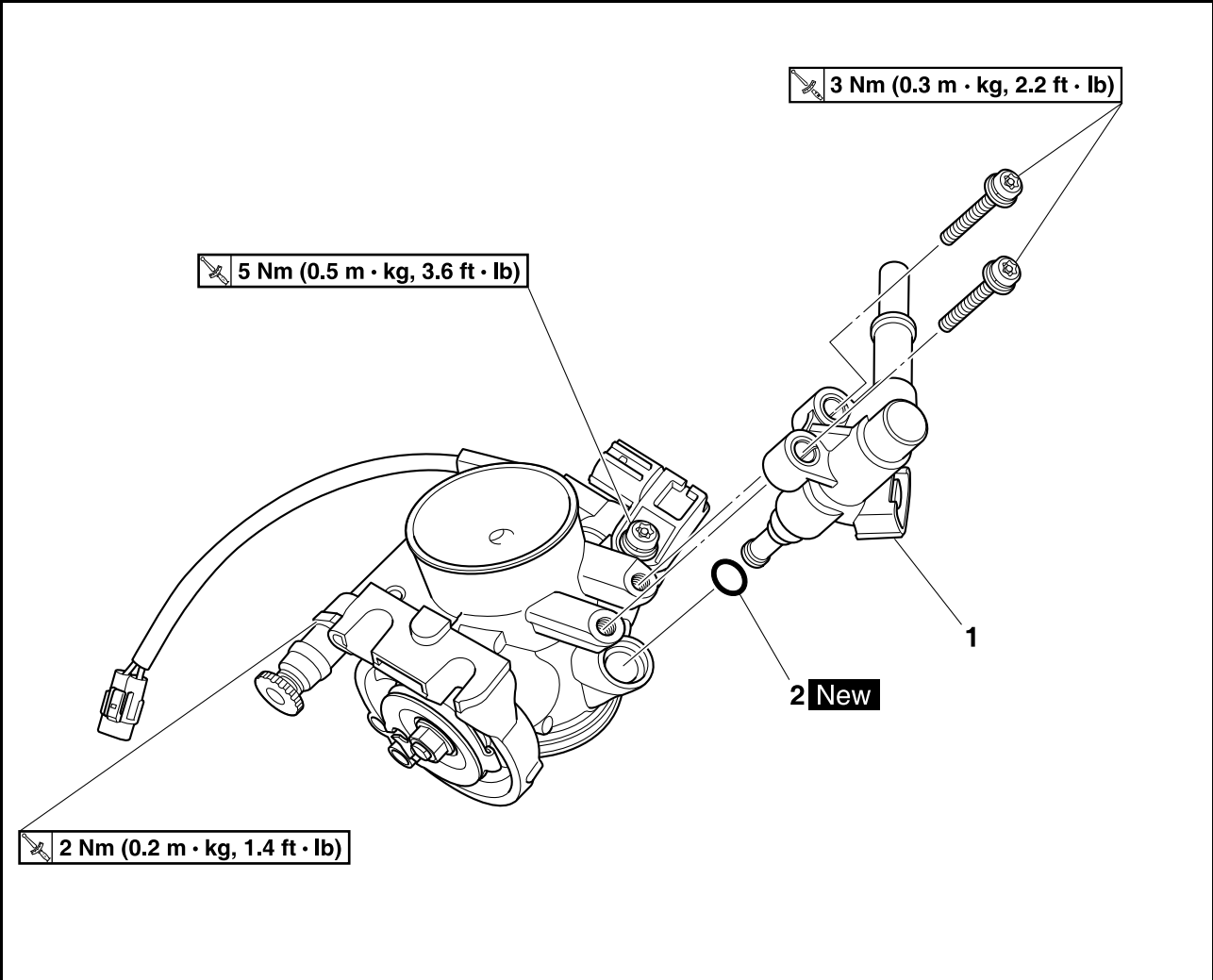

Order	Part name	Q'ty	Remarks
1	Injector	1	
2	Gasket	2	

THROTTLE BODY

CHECKING THE INJECTOR

⚠ WARNING

Replace the fuel injector with a new one if you have dropped or impacted it.

1. Check:
 - Injectors
 - Damage → Replace.

CHECKING THE THROTTLE BODY

NOTICE

- Before removing the throttle body, clean the area around the throttle body to prevent dirt and other foreign material from falling into the engine.
- If the throttle body is subject to strong shocks or dropped during cleaning, replace it.
- Do not use any caustic carburetor cleaning solution.
- Do not directly push the throttle valves to open them.
- Do not loosen the throttle valve stopper screw "1", throttle valve pulley nut "2", or throttle valve screw "3". Otherwise, a loss of performance may occur.
- Do not use compressed air to clean the throttle body. Otherwise, foreign material may adhere to the intake air pressure sensor passage "a" and fuel injector "b" in the throttle body.

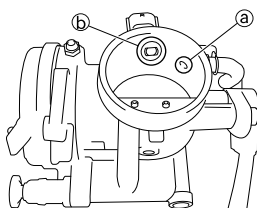
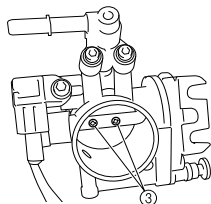
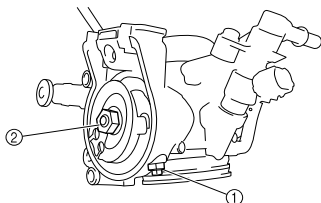

1. Check:
 - Throttle body
 - Cracks/damage → Replace the throttle body as a set.
2. Check:
 - Starter knob/ idle screw delivery passages "a"
 - Obstructions → Blow out with compressed air.

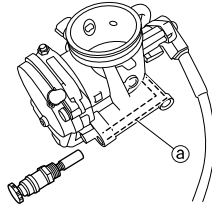

ASSEMBLING THE THROTTLE BODY

1. Install:
 - O-ring "1" **New**
 - Injector "2"
 - Bolt "3"

	Bolt (injector) 3 Nm (0.3 kg•m, 2.2 ft•lb)
---	--

NOTICE

Always use a new O-ring.

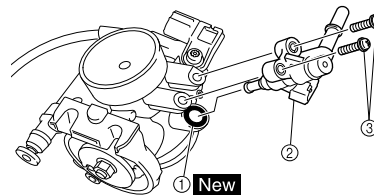

INSTALLING THE THROTTLE BODY

1. Install:
 - Throttle body joint "1"
 - Throttle body "2"

TIP

- Face the slot "a" in the throttle body joint toward the bottom of the vehicle.
- Align the slot "a" on the throttle body joint with the projection "b" on the throttle body.

	Throttle body joint clamp screw 3 Nm (0.3 m•kg, 2.2 ft•lb)
---	--

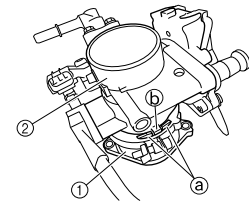

2. Install the water-resistant cover "1" onto the throttle body.

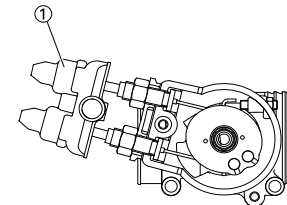

CHECKING AND REPLACING THE PROTECTOR

1. Check:
 - Protector "1"
 - Wear/damage → Replace.

TIP

Affix the protector as shown.

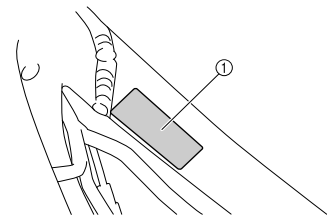

ELECTRICAL COMPONENTS AND WIRING DIAGRAM

ELECTRICAL

TIP

This section is intended for those who have basic knowledge and skill concerning the servicing of Yamaha motorcycles (e.g., Yamaha dealers, service engineers, etc.) Those who have little knowledge and skill concerning servicing are requested not to undertake inspection, adjustment, disassembly, or reassembly only by reference to this manual. It may lead to servicing trouble and mechanical damage.

ELECTRICAL COMPONENTS AND WIRING DIAGRAM

ELECTRICAL COMPONENTS

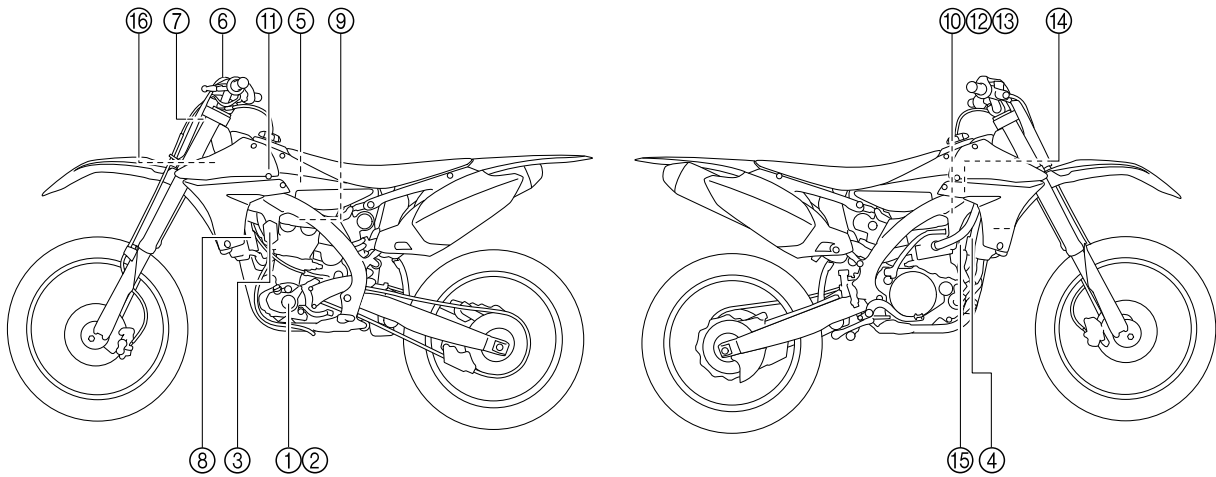

- | | |
|-------------------------------|--|
| 1. Crankshaft position sensor | 9. Spark plug |
| 2. AC magneto | 10. Fuel injector |
| 3. Rectifier/regulator | 11. Intake air temperature sensor |
| 4. Condenser | 12. Intake air pressure sensor |
| 5. Fuel pump | 13. Throttle position sensor |
| 6. Engine stop switch | 14. Atmospheric pressure sensor |
| 7. ECU | 15. Coolant temperature sensor |
| 8. Ignition coil | 16. Coupler for connecting optional part |

ELECTRICAL COMPONENTS AND WIRING DIAGRAM

WIRING DIAGRAM

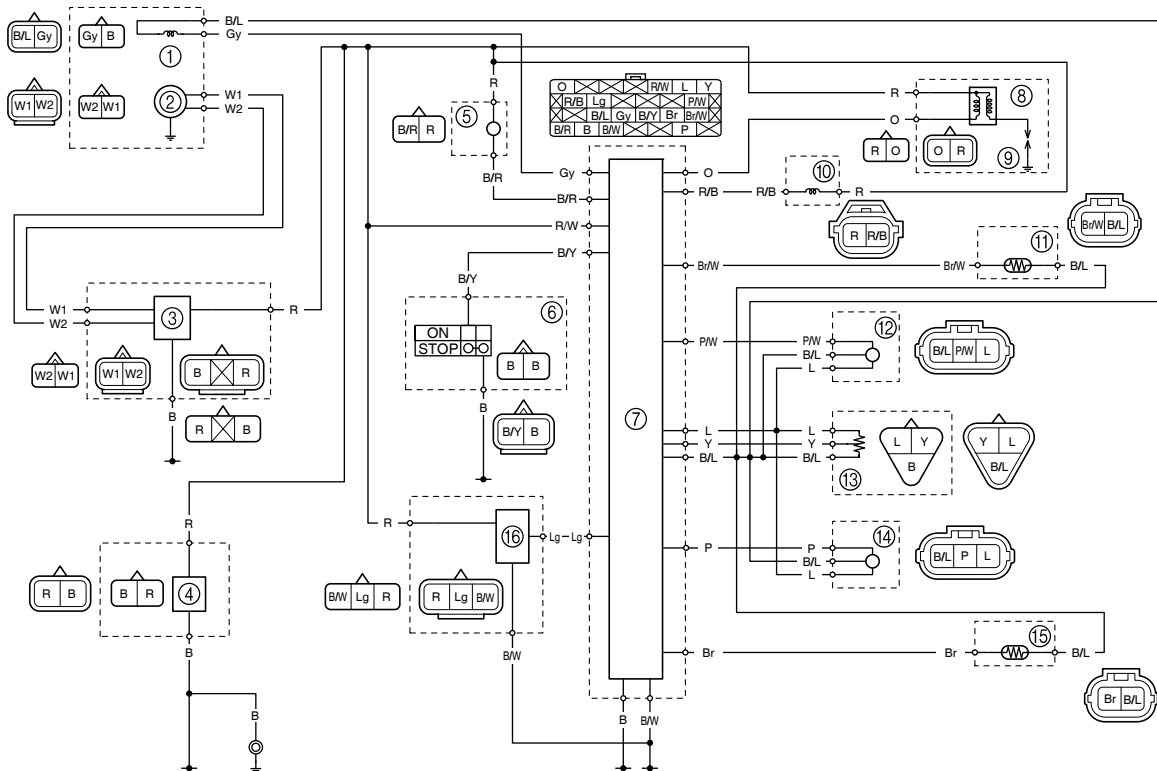

1. Crankshaft position sensor
2. AC magneto
3. Rectifier/regulator
4. Condenser
5. Fuel pump
6. Engine stop switch
7. ECU
8. Ignition coil
9. Spark plug
10. Fuel injector
11. Intake air temperature sensor
12. Intake air pressure sensor
13. Throttle position sensor
14. Atmospheric pressure sensor
15. Coolant temperature sensor
16. Coupler for connecting optional part

COLOR CODE

B	Black
Br	Brown
Gy	Gray
L	Blue
Lg	Light green
O	Orange
P	Pink
R	Red
W	White
Y	Yellow
B/L	Black/Blue
B/R	Black/Red
B/W	Black/White
B/Y	Black/Yellow
Br/W	Brown/White
P/W	Pink/White
R/B	Red/Black
R/W	Red/White

IGNITION SYSTEM

IGNITION SYSTEM

INSPECTION STEPS

Use the following steps for checking the possibility of the malfunctioning engine being attributable to ignition system failure and for checking the spark plug which will not spark.

Spark gap test	Spark →	<ul style="list-style-type: none"> • *Clean or replace spark plug. • Check the connection of the spark plug cap to the spark plug.
No spark ↓		
Check entire ignition system for connection. (couplers, leads and ignition coil)	No good →	Repair or replace.
OK ↓		
Check engine stop switch.	No good →	Replace.
OK ↓		
Check ignition coil. (primary coil and secondary coil)	No good →	Replace.
OK ↓		
Check AC magneto. (crankshaft position sensor and stator coil)	No good →	Replace.
OK ↓		
Replace ECU.		

***marked: Only when the ignition checker is used.**

TIP

- Remove the following parts before inspection.
 1. Seat
 2. Fuel tank
- Use the following special tools in this inspection.

	Dynamic spark tester: YM-34487 Ignition checker: 90890-06754 Pocket tester: YU-03112-C/90890-03112
---	---

SPARK GAP TEST

1. Disconnect the spark plug cap from spark plug.
2. Connect the dynamic spark tester "1" (ignition checker "2") as shown.
 - Spark plug cap "3"
 - Spark plug "4"

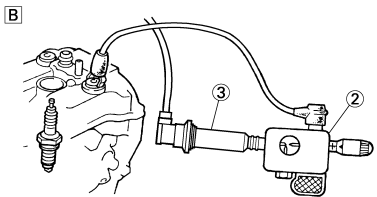
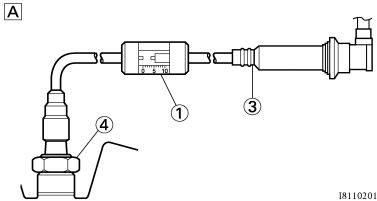

- A. For USA and CDN
 B. Except for USA and CDN

3. Kick the kickstarter crank.
4. Check the ignition spark gap.
5. Start engine, and increase spark gap until misfire occurs. (for USA and CDN only)

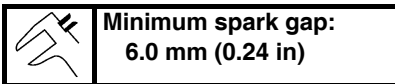

6. Inspect:
 - Sealed portion of spark plug cap "a"
 - Spark plug terminal pin "b"
 - Threaded portion of spark plug "c"

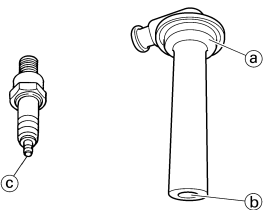

7. Inspect:
 - Installed condition of spark plug and spark plug cap
 Push in the spark plug cap, making sure that it is securely fitted into the hole in the cylinder head cover.

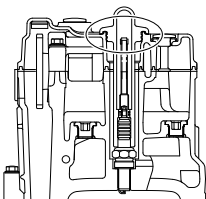

CHECKING THE COUPLERS AND LEADS CONNECTION

1. Check:
 - Couplers and leads connection
 Rust/dust/looseness/short-circuit
 → Repair or replace.

CHECKING THE ENGINE STOP SWITCH

1. Inspect:
 - Engine stop switch conduction

Tester (+) lead → Black lead "1"
 Tester (-) lead → Black lead "2"

	Result Conductive (while the engine stop switch is pushed)
--	--

Not conductive while it is pushed → Replace.

Conductive while it is freed → Replace.

TIP
 Set the tester selection position to " $\Omega \times 1$ ".

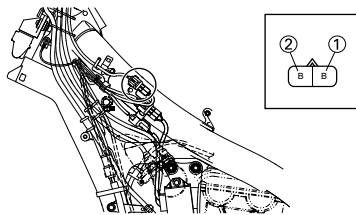

CHECKING THE IGNITION COIL

1. Remove the ignition coil cap.
2. Inspect:
 - Primary coil resistance
 Out of specification → Replace.

Tester (+) lead → Orange lead "1"
 Tester (-) lead → Red lead "2"

	Primary coil resistance	Tester selector position
	3.57–4.83 Ω at 20°C (68°F)	$\Omega \times 1$

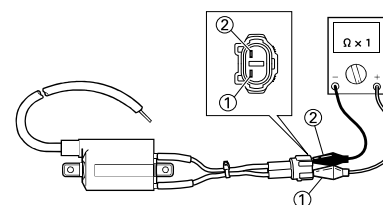

3. Inspect:
 - Secondary coil resistance
 Out of specification → Replace.

Tester (+) lead → Orange lead "1"
 Tester (-) lead → Spark plug terminal "2"

	Secondary coil resistance	Tester selector position
	10.71–14.49 k Ω at 20°C (68°F)	k $\Omega \times 1$

TIP
 Disconnect the spark plug cap before measuring the secondary coil resistance.

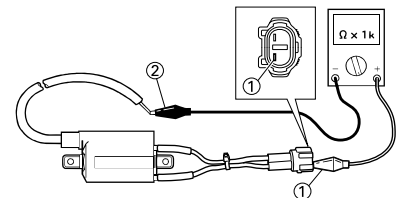

CHECKING THE AC MAGNETO

1. Inspect:
 - Crankshaft position sensor resistance
 Out of specification → Replace.

Tester (+) lead → Gray lead "1"
 Tester (-) lead → Black lead "2"

	Crankshaft position sensor resistance	Tester selector position
	248–372 Ω at 20°C (68°F)	$\Omega \times 100$

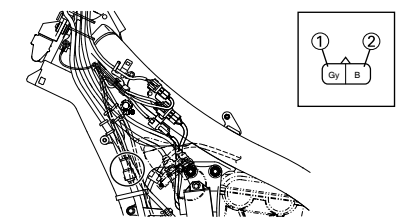

2. Inspect:

- Stator coil resistance
Out of specification → Replace.

Tester (+) lead → White lead "1"
Tester (-) lead → White lead "2"

	Stator coil resistance	Tester selector position
	0.60–0.90 Ω at 20°C (68°F)	$\Omega \times 10$

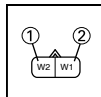
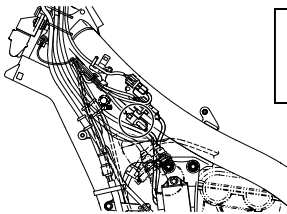

CHECKING THE ECU

1. Check:
 - All electrical components.
2. Check:
 - ECU installation status
Make sure that the ECU is installed correctly.

TIP

- The lean angle sensor is built into the ECU.
- The lean angle sensor stops the engine in case of a turnover.
- To ensure that the lean angle sensor operates correctly, do not change the installation position of the sensor.

3. Check:

- ECU
If no fault is found, replace the ECU.

THROTTLE POSITION SENSOR SYSTEM

THROTTLE POSITION SENSOR SYSTEM

INSPECTION STEPS

If the throttle position sensor will not operate, use the following inspection steps.

Check entire ignition system for connection.	No good →	Repair or replace.
OK ↓		
Check throttle position sensor.	No good →	Replace.
OK ↓		
*Check AC magneto.	No good →	Replace.
OK ↓		
Check ECU. (Throttle position sensor input voltage)	No good →	Replace.

*marked: Refer to "IGNITION SYSTEM" section.

TIP

Use the following special tools in this inspection.

	Model 88 Multimeter with tacometer: YU-A1927 Digital circuit tester: 90890-03174 Test harness-speed sensor (3P): YU-03208/90890-03208
---	---

THROTTLE POSITION SENSOR SYSTEM

HANDLING NOTE

NOTICE

Do not loosen the screw (throttle position sensor) "1" except when changing the throttle position sensor due to failure because it will cause a drop in engine performance.

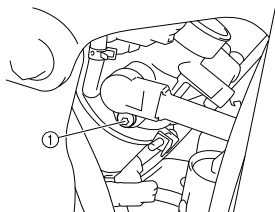

CHECKING THE COUPLERS AND LEADS CONNECTION

- Check:
 - Couplers and leads connection
 - Rust/dust/looseness/short-circuit
 → Repair or replace.

CHECKING THE THROTTLE POSITION SENSOR

- Inspect:
 - Throttle position sensor resistance
 Out of specification → Replace.

Tester (+) lead → Blue lead "1"
Tester (-) lead → Black lead "2"

	Throttle position sensor coil resistance	Tester selector position
	4-6 kΩ at 20°C (68 °F)	kΩ x1

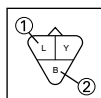
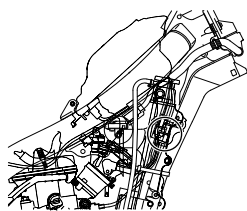

- Inspect:
 - Throttle position sensor variable resistance
 Check that the resistance is increased as the throttle grip is moved from the full close position to the full open position.
Out of specification → Replace.

Tester (+) lead → Yellow lead "1"
Tester (-) lead → Black lead "2"

	Throttle position sensor coil variable resistance		Tester selector position
	Full closed	Full opened	kΩ x1
	Zero -2 kΩ at 20°C (68°F)	4-6 kΩ at 20°C (68°F)	

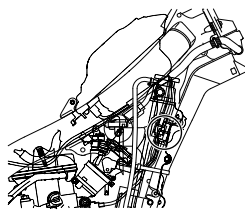

CHANGING AND ADJUSTING THE THROTTLE POSITION SENSOR

- Remove:
 - Throttle position sensor coupler
- Remove:
 - Screw (throttle position sensor) "1"
 - Throttle position sensor "2"

TIP

Loosen the screw (throttle position sensor) using the T25 bit.

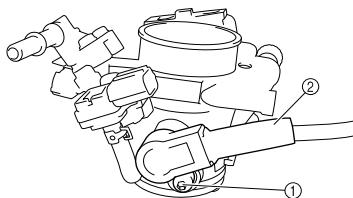

- Replace:
 - Throttle position sensor
- Install:
 - Throttle position sensor "1"
 - Screw (throttle position sensor) "2"

TIP

- Align the projection "b" on the throttle body with the slot "a" in the throttle position sensor.
- Temporarily tighten the screw (throttle position sensor).

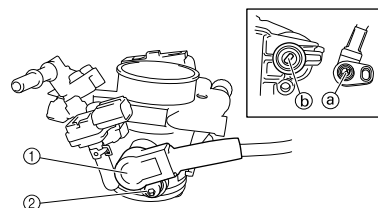

- Make sure that the throttle grip is in the fully closed position.
- Install:
 - Throttle position sensor coupler
- Connect the FI diagnostic tool. (Refer to "CONNECTING THE FI DIAGNOSTIC TOOL".)
- Set the FI diagnostic tool to the diagnostic mode, and then select diagnostic code No. D01. (Refer to "SETTING THE DIAGNOSTIC MODE".)
- Adjust the position of the throttle position sensor so that the angle displayed on the LCD of the FI diagnostic tool is 12-21°.
- After adjusting the throttle position sensor angle, tighten the throttle position sensor screw "1".

TIP

Tighten the screw (throttle position sensor) using the T25 bit.

	Screw (throttle position sensor) 3 Nm (0.3 m•kg, 2.2 ft•lb)
--	--

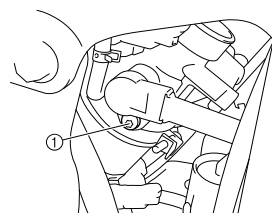

THROTTLE POSITION SENSOR SYSTEM

CHECKING THE THROTTLE POSITION SENSOR INPUT VOLTAGE

1. Disconnect the throttle position sensor coupler.
2. Connect the test harness-speed sensor (3P) "1" as shown.

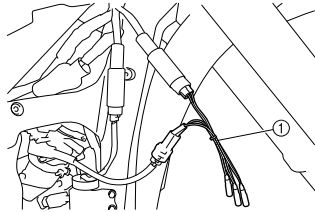
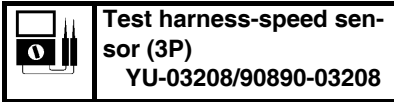

3. Start the engine.
4. Inspect:
 - Throttle position sensor input voltage
Out of specification → Replace the ECU.

Tester (+) lead → Blue lead (wire harness color)
Tester (-) lead → Black/Blue lead (wire harness color)

	Throttle position sensor input voltage	Tester selector position
	4-6 V	DCV-20

FUEL INJECTION SYSTEM

TROUBLESHOOTING METHOD

Engine starting problems, engine idling speed problems, and medium and high-speed performance problems

- CHECK:
 - Refer to "TROUBLESHOOTING" section in the chapter 3.
- Connect the FI diagnostic tool. (Refer to "CONNECTING THE FI DIAGNOSTIC TOOL".)
- Check the fault code number. (Refer to "TROUBLESHOOTING DETAILS".)

TIP

- Check the fault code number that is displayed on the LCD of the FI diagnostic tool.
- Identify the system with the malfunction. (Refer to "TROUBLESHOOTING DETAILS".)

- Checking and repair the probable case of malfunction.

- Fault code No. YES. Check and repair. Refer to "TROUBLESHOOTING DETAILS". Refer to "SENSOR OPERATION TABLE".

- Fault code No. NO. Check each sensor and actuator in the diagnostic mode. Refer to "SETTING THE DIAGNOSTIC MODE". Refer to "SENSOR OPERATION TABLE".

If the sensors or actuators are damaged, check and, if necessary, repair or replace all faulty parts.

If the sensors or actuators are not damaged, check and, if necessary, repair or replace the engine inner parts.

- Perform ECU reinstatement action. Refer to "Reinstatement method" of table in "TROUBLESHOOTING DETAILS".

- Set the switch on the FI diagnostic tool sub-wire harness from "OFF" to "ON", and then check whether a fault code number is displayed again.

TIP

If other fault code displayed, repeat steps (2) to (5) until all fault code number is not displayed.

- Set the switch on the FI diagnostic tool sub-wire harness to "OFF", and then disconnect the FI diagnostic tool, FI diagnostic tool sub-wire harness, and battery. Place the accessory coupler in its original position.

TIP

The malfunction history is stored even if the switch on the FI diagnostic tool sub-wire harness is set to "OFF". Erase the malfunction history in the diagnostic mode. (Refer to "DIAGNOSTIC CODE TABLE (Diagnostic code No. D62)".)

CONNECTING THE FI DIAGNOSTIC TOOL

- Connect the following items to the accessory coupler as shown.
 - FI diagnostic tool "1"
 - FI diagnostic tool sub-wire harness "2"
 - Battery "3"

TIP

- Because this vehicle is not equipped with a battery, a 12 V battery is required to use the FI diagnostic tool.
- Make sure that the switch on the FI diagnostic tool sub-wire harness is set to "OFF".
- The "POWER" LED (green) comes on.

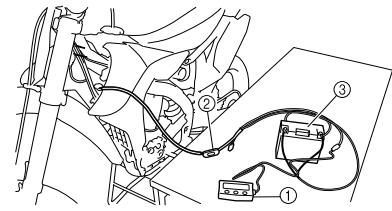

CHECKING THE FAULT CODES

- Set the switch on the FI diagnostic tool subwire harness to "ON".

TIP

When the switch on the FI diagnostic tool sub-wire harness is set to "ON", make sure that "Waiting for connection" is displayed on the LCD of the FI diagnostic tool.

- Check:
 - Fault code number

TIP

- If a malfunction is detected in the system, the fault code appears on the LCD of the FI diagnostic tool and the "WARNING" LED (orange) comes on.
- To start the engine, set the switch on the FI diagnostic tool sub-wire harness to "OFF".
- When the engine is running, fault code numbers will not be displayed on the LCD of the FI diagnostic tool even if a malfunction is detected in the system. The "WARNING" LED (orange) comes on.

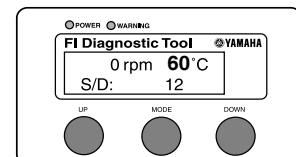
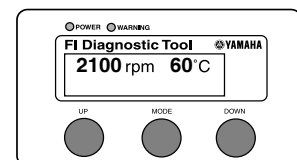

- Set the switch on the FI diagnostic tool subwire harness to "OFF".

	FI diagnostic tool
	YU-03182/90890-03182
	FI diagnostic tool sub-wire harness
	YU-03212/90890-03212

SETTING THE DIAGNOSTIC MODE

TIP

When the FI diagnostic tool is set to the diagnostic mode, the sensor output data can be displayed and the operation of the actuators can be checked.

1. While pressing the "MODE" button, set the switch on the FI diagnostic tool sub-wire harness to "ON".

TIP

- When the switch on the FI diagnostic tool sub-wire harness is set to "ON", make sure that "Waiting for connection" is displayed on the LCD of the FI diagnostic tool.
- "DIAG" appears on the LCD of the FI diagnostic tool.

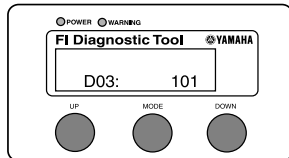

2. Select the diagnostic mode "DIAG" by pressing the "UP" button.
3. After selecting "DIAG", press the "MODE" button.
4. Select the diagnostic code number corresponding to the fault code number by pressing the "UP" and "DOWN" buttons.

TIP

- Select the diagnostic code number corresponding to the fault code number by pressing the "UP" and "DOWN" buttons.
- To decrease the selected diagnostic code number, press the "DOWN" button. Press the "DOWN" button for 1 second or more to automatically decrease the diagnostic code numbers.
- To increase the selected diagnostic code number, press the "UP" button. Press the "UP" button for 1 second or more to automatically increase the diagnostic code numbers.

5. Check the operation of the sensor or actuator.
 - Sensor display: Data indicating the sensor status is displayed on the LCD of the FI diagnostic tool.
 - Actuator operation: Press the "MODE" button to operate the actuator.
6. Set the switch on the FI diagnostic tool sub-wire harness to "OFF".

FUEL INJECTION SYSTEM

SENSOR OPERATION TABLE

Diagnostic code No.	Item	Actuation or display	Checking method	Actuation or LCD standard display values
D01	Throttle angle	Display	Displays the throttle angle. Check with throttle fully closed. Check with throttle fully open.	0–125° When throttle is fully closed:15–19° When throttle is fully opened:95–101 °
D02	Atmosphere	Display	Displays the atmospheric pressure. • Measure the atmospheric pressure.	0–126 kPa Displays the atmospheric pressure according to the elevation and weather. Example 0 m above sea level: Approx: 101 kPa 3000 m above sea level:Approx: 70 kPa
D03	Intake air pressure	Display	Displays the intake air pressure. • Check the intake manifold pressure. • Check that the intake air pressure changes while the engine is being cranked.	0–126 kPa While the engine is stopped: Displays the atmospheric pressure according to the elevation and weather. Example 0 m above sea level: Approx: 101 kPa 3000 m above sea level:Approx: 70 kPa While the engine is being cranked: Displays the intake air pressure.
D05	Intake air temperature	Display	Displays the intake air temperature. • Check the temperature in the intake manifold.	-20–100°C Cold engine: Displayed temperature is close to the ambient temperature. Warm engine: Displayed temperature is approximately 20 °C higher than the ambient temperature.
D06	Coolant temperature	Display	Displays the coolant temperature. • Check the coolant temperature.	-20–150°C Cold engine: Displayed temperature is close to the ambient temperature. Warm engine: Displayed temperature is the current coolant temperature.
D08	Lean angle sensor	Display	Displays the lean angle sensor output voltage. Remove the ECU and incline it 45° or more.	0–5.0 V 1.0 V: Upright 4.0 V: Overturned
D30	Ignition coil	Actuation	Check that power is supplied to the ignition coil. • Check that a spark is generated. • Illuminates the engine trouble warning light.	Actuates the ignition coil for five times every second. The "WARNING" LED on the FI diagnostic tool comes on each time the fuel injector is actuated.

FUEL INJECTION SYSTEM

Diagnostic code No.	Item	Actuation or display	Checking method	Actuation or LCD standard display values
D36	Injectors	Actuation	<p>Check that power is supplied to the fuel injector.</p> <ul style="list-style-type: none"> Check the fuel injector operation by listening for the operating sound or by confirming the operation visually. 	<p>Actuates the injector for five times every second.</p> <p>The "WARNING" LED on the FI diagnostic tool comes on each time the fuel injector is actuated.</p>
D60	EEPROM fault code display.	Display	<p>Displays the abnormal portion of the data in the EEPROM that has been detected as a fault code No. 44.</p> <p>If code numbers more than one are detected, the display alternates every two seconds to show all the detected code numbers. When all code numbers are shown, the display repeats the same process.</p>	<p>00: No fault</p> <p>01: CO adjustment valve</p> <p>07: Power Tuner adjustment values 0–8 for fuel injection amount or ignition timing</p>
D61	Malfunction history code display.	Display	<p>Displays the fault code numbers that are stored in the malfunction history.</p> <p>If code numbers more than one are detected, the display alternates every two seconds to show all the detected code numbers. When all code numbers are shown, the display repeats the same process.</p>	<p>00: No history</p> <p>12–50: History exists</p> <ul style="list-style-type: none"> Refer to the fault code number.
D62	Malfunction history code erasure	Actuation and display	<p>Displays the total number of malfunctions, including the current malfunction, that have occurred since the history was last erased. In addition, deletes the fault code numbers from the history if the corresponding items are currently operating normally.</p>	<p>00: No history</p> <p>1–15: History exists</p> <p>When this diagnostic code number is selected, fault code numbers for previously detected malfunctions are deleted from the history if the corresponding items are currently operating normally.</p>
D64	Setting history display	Display	<p>Displays whether or not history exists for settings that were made using the Power Tuner.</p>	<p>00: There is no setting history.</p> <p>01: There is setting history.</p> <p>02: Whether or not setting history data exists cannot be determined (damage to history data).</p>
D65	Setting map erasure	Display	<p>Erases the settings that were made using the Power Tuner.</p>	<p>00: There are no settings that were made using the Power Tuner.</p> <p>01: There are settings that were made using the Power Tuner.</p>
D70	Program version number	Display	<p>Check the version number of the program.</p>	<p>0–254</p>

FUEL INJECTION SYSTEM

TROUBLESHOOTING DETAILS

This section describes the countermeasures per fault code number displayed on the FI diagnostic tool. Check and service the items or components that are the probable cause of the malfunction following the order given. After the check and service of the malfunctioning part have been completed, reset the FI diagnostic tool display according to the "Reinstatement method".

Fault code No.

Fault code number displayed on the FI diagnostic tool when the engine failed to work normally. Refer to "FAULT CODE TABLE".

Diagnostic code No.

Diagnostic code number to be used when the diagnostic mode is operated. Refer to "DIAGNOSTIC CODE TABLE".

Fault code No.	12		
Symptom	No normal signals are received from the crankshaft position sensor.		
Fail-safe system	Able to start		
	Able to drive		
Diagnostic code No.	—		
FI diagnostic tool display	—		
Checking method	—		
Item	Item/components and probable cause	Check or maintenance job	Checking method
1	Check the connection and locking condition of the crankshaft position sensor coupler. Disconnect the coupler and check the pins. (bent or broken terminals and locking condition of the pins)	Poor connection → Properly connect, repair, or replace.	Crank the engine and check the fault code display. Fault code number is not displayed → Service is finished. Fault code number is displayed → Refer to item 2.
2	Check the connection and locking condition of the wire harness ECU coupler. Disconnect the coupler and check the pins. (bent or broken terminals and locking condition of the pins)	Poor connection → Properly connect, repair, or replace.	Crank the engine and check the fault code display. Fault code number is not displayed → Service is finished. Fault code number is displayed → Refer to item 3.
3	Continuity of harness	Open or short circuit → Replace. Between the crankshaft position sensor coupler and ECU coupler. (Gray–Gray) (Black/Blue–Black/Blue)	Crank the engine and check the fault code display. Fault code number is not displayed → Service is finished. Fault code number is displayed → Refer to item 4.
4	Installed condition of sensor. Check that the gap between the crankshaft position sensor and the rotor is 0.85 mm.	Check that the sensor is installed securely and that there are no pinched leads. Check that the ECU is installed securely and that there are no pinched leads. Incorrect installation → Reinstall or repair.	Crank the engine and check the fault code display. Fault code number is not displayed → Service is finished. Fault code number is displayed → Refer to item 5.

FUEL INJECTION SYSTEM

Fault code No.	12		
Symptom	No normal signals are received from the crankshaft position sensor.		
Fail-safe system	Able to start		
	Able to drive		
Diagnostic code No.	—		
FI diagnostic tool display	—		
Checking method	—		
Item	Item/components and probable cause	Check or maintenance job	Checking method
5	Defective crankshaft position sensor.	Sensor malfunction → Replace. Refer to "CHECKING THE AC MAGNETO" section.	Crank the engine and check the fault code display. Fault code number is not displayed → Service is finished. Fault code number is displayed → Refer to item 6.
6	Malfunction in ECU.	Replace the ECU.	

NOTICE

If fault code Nos. 13 and 14 are both displayed, perform the checks and maintenance jobs for fault code No. 13 first.

Fault code No.	13		
Symptom	Intake air pressure sensor signal is not received properly.		
Fail-safe system	Able to start		
	Able to drive		
Diagnostic code No.	D03		
FI diagnostic tool display	Intake air pressure		
Checking method	Crank the engine. (If the display value changes, the performance is OK.)		
Item	Item/components and probable cause	Check or maintenance job	Checking method
1	Check the connection and locking condition of the intake air pressure sensor coupler. Disconnect the coupler and check the pins. (bent or broken terminals and locking condition of the pins)	Poor connection → Properly connect, repair, or replace.	Set the switch on the FI diagnostic tool sub-wire harness to "ON", and then check the fault code display. Fault code number is not displayed → Service is finished. Fault code number is displayed → Refer to item 2.
2	Check the connection and locking condition of the wire harness ECU coupler. Disconnect the coupler and check the pins. (bent or broken terminals and locking condition of the pins)	Poor connection → Properly connect, repair, or replace.	Set the switch on the FI diagnostic tool sub-wire harness to "ON", and then check the fault code display. Fault code number is not displayed → Service is finished. Fault code number is displayed → Refer to item 3.

FUEL INJECTION SYSTEM

Fault code No.	13		
Symptom	Intake air pressure sensor signal is not received properly.		
Fail-safe system	Able to start		
	Able to drive		
Diagnostic code No.	D03		
FI diagnostic tool display	Intake air pressure		
Checking method	Crank the engine. (If the display value changes, the performance is OK.)		
Item	Item/components and probable cause	Check or maintenance job	Checking method
3	Continuity of harness	Open or short circuit → Replace. Between the intake air pressure sensor coupler and ECU coupler. (Black/Blue–Black/Blue) (Pink/White–Pink/White) (Blue–Blue)	Set the switch on the FI diagnostic tool sub-wire harness to "ON", and then check the fault code display. Fault code number is not displayed → Service is finished. Fault code number is displayed → Refer to item 4.
4	Installed condition of sensor. Make sure that the installation position is correct.	Check that the sensor is installed securely and that there are no pinched leads. Check that the ECU is installed securely and that there are no pinched leads. Incorrect installation → Reinstall or repair. Incorrect installation position → Properly install.	Set the switch on the FI diagnostic tool sub-wire harness to "ON", and then check the fault code display. Fault code number is not displayed → Service is finished. Fault code number is displayed → Refer to item 5.
5	Defective intake air pressure sensor.	Execute the diagnostic mode (diagnostic code No. D03). When the engine is stopped, displays the atmospheric pressure according to the elevation and weather. 0 m above sea level: Approx. 101 kPa 1000 m above sea level: Approx. 90 kPa 2000 m above sea level: Approx. 80 kPa 3000 m above sea level: Approx. 70 kPa Check that the value changes while the engine is being cranked. Displayed value is incorrect → Replace.	Set the switch on the FI diagnostic tool sub-wire harness to "ON", and then check the fault code display. Fault code number is not displayed → Service is finished. Fault code number is displayed → Refer to item 6.
6	Malfunction in ECU.	Replace the ECU.	

FUEL INJECTION SYSTEM

NOTICE

If fault code Nos. 13 and 14 are both displayed, perform the checks and maintenance jobs for fault code No. 13 first.

Fault code No.	14		
Symptom	Intake air pressure sensor system malfunction detected. (clogged hole or disconnected sensor)		
Fail-safe system	Able to start		
	Able to drive		
Diagnostic code No.	D03		
FI diagnostic tool display	Intake air pressure		
Checking method	Crank the engine. (If the display value changes, the performance is OK.)		
Item	Item/components and probable cause	Check or maintenance job	Checking method
1	Intake air pressure sensor hose is clogged, damaged, disconnected, kinked, pinched, or twisted.	Repair or replace.	Start the engine and let it idle for approximately 5 seconds with the throttle fully closed. After completing the above operation, check whether a fault code number is displayed. Fault code number is not displayed → Service is finished. Fault code number is displayed → Refer to item 2.
2	Defective intake air pressure sensor.	Execute the diagnostic mode (diagnostic code No. D03). When the engine is stopped, displays the atmospheric pressure according to the elevation and weather. 0 m above sea level: Approx. 101 kPa 1000 m above sea level: Approx. 90 kPa 2000 m above sea level: Approx. 80 kPa 3000 m above sea level: Approx. 70 kPa Display value does not change → Replace the sensor.	

FUEL INJECTION SYSTEM

Fault code No.	15		
Symptom	Throttle position sensor signal is not received properly.		
Fail-safe system	Able to start		
	Able to drive		
Diagnostic code No.	D01		
FI diagnostic tool display	<ul style="list-style-type: none"> • 15–19° (Fully closed position) • 95–101° (Fully opened position) 		
Checking method	<ul style="list-style-type: none"> • Check with throttle valves fully closed. • Check with throttle valves fully open. 		
Item	Item/components and probable cause	Check or maintenance job	Checking method
1	Check the connection and locking condition of the throttle position sensor coupler. Disconnect the coupler and check the pins. (bent or broken terminals and locking condition of the pins)	Poor connection → Properly connect, repair, or replace.	Set the switch on the FI diagnostic tool sub-wire harness to "ON", and then check the fault code display. Fault code number is not displayed → Service is finished. Fault code number is displayed → Refer to item 2.
2	Check the connection and locking condition of the wire harness ECU coupler. Disconnect the coupler and check the pins. (bent or broken terminals and locking condition of the pins)	Poor connection → Properly connect, repair, or replace.	Set the switch on the FI diagnostic tool sub-wire harness to "ON", and then check the fault code display. Fault code number is not displayed → Service is finished. Fault code number is displayed → Refer to item 3.
3	Continuity of harness	Open or short circuit → Replace. Between throttle position sensor coupler and ECU coupler. (Black/Blue–Black/Blue) (Yellow–Yellow) (Blue–Blue)	Set the switch on the FI diagnostic tool sub-wire harness to "ON", and then check the fault code display. Fault code number is not displayed → Service is finished. Fault code number is displayed → Refer to item 4.
4	Installed condition of sensor. <ul style="list-style-type: none"> • Make sure that the installation position is correct. • Make sure that there are no problems with the installation. 	Check that the sensor is installed securely and that there are no pinched leads. Check that the ECU is installed securely and that there are no pinched leads. Incorrect installation → Reinstall or repair. Incorrect installation position → Properly install.	Set the switch on the FI diagnostic tool sub-wire harness to "ON", and then check the fault code display. Fault code number is not displayed → Service is finished. Fault code number is displayed → Refer to item 5.

FUEL INJECTION SYSTEM

Fault code No.	15			
Symptom	Throttle position sensor signal is not received properly.			
Fail-safe system	Able to start			
	Able to drive			
Diagnostic code No.	D01			
FI diagnostic tool display	<ul style="list-style-type: none"> • 15–19° (Fully closed position) • 95–101° (Fully opened position) 			
Checking method	<ul style="list-style-type: none"> • Check with throttle valves fully closed. • Check with throttle valves fully open. 			
Item	Item/components and probable cause	Check or maintenance job		Checking method
5	Applied voltage of throttle position sensor lead	Measure the output voltage. Refer to "CHECKING THE THROTTLE POSITION SENSOR".		Set the switch on the FI diagnostic tool sub-wire harness to "ON", and then check the fault code display. Fault code number is not displayed → Service is finished. Fault code number is displayed → Refer to item 6.
		Open circuit item	Applied voltage	
		Ground wire open circuit	5 V	
		Output wire open circuit	0 V	
		Power supply wire open circuit	0 V	
6	Defective throttle position sensor.	Execute the diagnostic mode (diagnostic code No. D01). When throttle is fully closed: A value of 15–19 is indicated. When throttle is fully opened: A value of 95–101 is indicated. Displayed value is out of specification → Replace.		Set the switch on the FI diagnostic tool sub-wire harness to "ON", and then check the fault code display. Fault code number is not displayed → Service is finished. Fault code number is displayed → Refer to item 7.
7	Malfunction in ECU.	Replace the ECU.		

FUEL INJECTION SYSTEM

Fault code No.	16		
Symptom	Signal from throttle position sensor does not change.		
Fail-safe system	Able to start		
	Able to drive		
Diagnostic code No.	D01		
FI diagnostic tool display	<ul style="list-style-type: none"> • 15–19° (Fully closed position) • 95–101° (Fully opened position) 		
Checking method	<ul style="list-style-type: none"> • Check with throttle valves fully closed. • Check with throttle valves fully open. 		
Item	Item/components and probable cause	Check or maintenance job	Checking method
1	Installed condition of sensor. <ul style="list-style-type: none"> • Make sure that the installation position is correct. • Make sure that there are no problems with the installation. 	Check that the sensor is installed securely and that there are no pinched leads. Check that the ECU is installed securely and that there are no pinched leads. Incorrect installation → Reinstall or repair. Incorrect installation position → Properly install.	Set the switch on the FI diagnostic tool sub-wire harness to "ON", and then operate the throttle. After completing the above operation, check whether a fault code number is displayed. Fault code number is not displayed → Service is finished. Fault code number is displayed → Refer to item 2.
2	Defective throttle position sensor.	Execute the diagnostic mode (diagnostic code No. D01). When throttle is fully closed: A value of 15–19 is indicated. When throttle is fully opened: A value of 95–101 is indicated. Displayed value is out of specification → Replace.	Set the switch on the FI diagnostic tool sub-wire harness to "ON", and then operate the throttle. After completing the above operation, check whether a fault code number is displayed. Fault code number is not displayed → Service is finished. Fault code number is displayed → Refer to item 3.
3	Malfunction in ECU.	Replace the ECU.	

FUEL INJECTION SYSTEM

NOTICE

Make sure that the engine is completely cool before checking the coolant temperature sensor.

Fault code No.	21		
Symptom	Coolant temperature sensor signal is not received properly.		
Fail-safe system	Able to start		
	Able to drive		
Diagnostic code No.	D06		
FI diagnostic tool display	-20–150°C Cold engine: Displayed temperature is close to the ambient temperature. Warm engine: Displayed temperature is the current coolant temperature.		
Checking method	Check the coolant temperature.		
Item	Item/components and probable cause	Check or maintenance job	Checking method
1	Check the connection and locking condition of the coolant temperature sensor coupler. Disconnect the coupler and check the pins (bent or broken terminals and locking condition of the pins).	Poor connection → Properly connect, repair, or replace.	Set the switch on the FI diagnostic tool sub-wire harness to "ON", and then check the fault code display. Fault code number is not displayed → Service is finished. Fault code number is displayed → Refer to item 2.
2	Check the connection and locking condition of the wire harness ECU coupler. Disconnect the coupler and check the pins. (bent or broken terminals and locking condition of the pins)	Poor connection → Properly connect, repair, or replace.	Set the switch on the FI diagnostic tool sub-wire harness to "ON", and then check the fault code display. Fault code number is not displayed → Service is finished. Fault code number is displayed → Refer to item 3.
3	Continuity of harness	Open or short circuit → Replace. Between coolant temperature sensor coupler and ECU coupler (Brown–Brown) (Black/Blue–Black/Blue)	Set the switch on the FI diagnostic tool sub-wire harness to "ON", and then check the fault code display. Fault code number is not displayed → Service is finished. Fault code number is displayed → Refer to item 4.
4	Installed condition of sensor.	Check that the sensor is installed securely and that there are no pinched leads. Check that the ECU is installed securely and that there are no pinched leads. Incorrect installation → Reinstall or repair.	Set the switch on the FI diagnostic tool sub-wire harness to "ON", and then check the fault code display. Fault code number is not displayed → Service is finished. Fault code number is displayed → Refer to item 5.

FUEL INJECTION SYSTEM

Fault code No.	21		
Symptom	Coolant temperature sensor signal is not received properly.		
Fail-safe system	Able to start		
	Able to drive		
Diagnostic code No.	D06		
FI diagnostic tool display	-20–150°C Cold engine: Displayed temperature is close to the ambient temperature. Warm engine: Displayed temperature is the current coolant temperature.		
Checking method	Check the coolant temperature.		
Item	Item/components and probable cause	Check or maintenance job	Checking method
5	Defective coolant temperature sensor.	Execute the diagnostic mode (diagnostic code No. D06). Cold engine: Displayed temperature is close to the ambient temperature. Displayed value is incorrect → Replace.	Set the switch on the FI diagnostic tool sub-wire harness to "ON", and then check the fault code display. Fault code number is not displayed → Service is finished. Fault code number is displayed → Refer to item 6.
6	Malfunction in ECU.	Replace the ECU.	

NOTICE

Make sure that the engine is completely cool before checking the intake air temperature sensor.

Fault code No.	22		
Symptom	Intake air temperature sensor signal is not received properly.		
Fail-safe system	Able to start		
	Able to drive		
Diagnostic code No.	D05		
FI diagnostic tool display	-20–100°C Cold engine: Displayed temperature is close to the ambient temperature. Warm engine: Displayed temperature is approximately 20°C higher than the ambient temperature.		
Checking method	Check the temperature in the intake manifold.		
Item	Item/components and probable cause	Check or maintenance job	Checking method
1	Check the connection and locking condition of the intake air temperature sensor coupler. Disconnect the coupler and check the pins. (bent or broken terminals and locking condition of the pins)	Poor connection → Properly connect, repair, or replace.	Set the switch on the FI diagnostic tool sub-wire harness to "ON", and then check the fault code display. Fault code number is not displayed → Service is finished. Fault code number is displayed → Refer to item 2.

FUEL INJECTION SYSTEM

Fault code No.	22		
Symptom	Intake air temperature sensor signal is not received properly.		
Fail-safe system	Able to start		
	Able to drive		
Diagnostic code No.	D05		
FI diagnostic tool display	-20–100°C Cold engine: Displayed temperature is close to the ambient temperature. Warm engine: Displayed temperature is approximately 20°C higher than the ambient temperature.		
Checking method	Check the temperature in the intake manifold.		
Item	Item/components and probable cause	Check or maintenance job	Checking method
2	Check the connection and locking condition of the wire harness ECU coupler. Disconnect the coupler and check the pins. (bent or broken terminals and locking condition of the pins)	Poor connection → Properly connect, repair, or replace.	Set the switch on the FI diagnostic tool sub-wire harness to "ON", and then check the fault code display. Fault code number is not displayed → Service is finished. Fault code number is displayed → Refer to item 3.
3	Continuity of harness	Open or short circuit → Replace. Between the intake air temperature sensor coupler and ECU coupler. (Brown/White–Brown/White) (Black/Blue–Black/Blue)	Set the switch on the FI diagnostic tool sub-wire harness to "ON", and then check the fault code display. Fault code number is not displayed → Service is finished. Fault code number is displayed → Refer to item 4.
4	Installed condition of sensor.	Check that the sensor is installed securely and that there are no pinched leads. Check that the ECU is installed securely and that there are no pinched leads. Incorrect installation → Reinstall or repair.	Set the switch on the FI diagnostic tool sub-wire harness to "ON", and then check the fault code display. Fault code number is not displayed → Service is finished. Fault code number is displayed → Refer to item 5.
5	Defective intake temperature sensor.	Execute the diagnostic mode (diagnostic code No. D05). Cold engine: Displayed temperature is close to the ambient temperature. Displayed value is incorrect → Replace.	Set the switch on the FI diagnostic tool sub-wire harness to "ON", and then check the fault code display. Fault code number is not displayed → Service is finished. Fault code number is displayed → Refer to item 6.
6	Malfunction in ECU.	Replace the ECU.	

FUEL INJECTION SYSTEM

Fault code No.	23		
Symptom	Atmospheric pressure sensor signal is not received properly.		
Fail-safe system	Able to start		
	Able to drive		
Diagnostic code No.	D02		
FI diagnostic tool display	Atmosphere		
Checking method	Measure the atmospheric pressure.		
Item	Item/components and probable cause	Check or maintenance job	Checking method
1	Check the connection and locking condition of the atmospheric pressure sensor coupler. Disconnect the coupler and check the pins. (bent or broken terminals and locking condition of the pins)	Poor connection → Properly connect, repair, or replace.	Set the switch on the FI diagnostic tool sub-wire harness to "ON", and then check the fault code display. Fault code number is not displayed → Service is finished. Fault code number is displayed → Refer to item 2.
2	Check the connection and locking condition of the wire harness ECU coupler. Disconnect the coupler and check the pins. (bent or broken terminals and locking condition of the pins)	Poor connection → Properly connect, repair, or replace.	Set the switch on the FI diagnostic tool sub-wire harness to "ON", and then check the fault code display. Fault code number is not displayed → Service is finished. Fault code number is displayed → Refer to item 3.
3	Continuity of harness	Open or short circuit → Replace. Between atmospheric pressure sensor coupler and ECU coupler. (Black/Blue–Black/Blue) (Pink–Pink) (Blue–Blue)	Set the switch on the FI diagnostic tool sub-wire harness to "ON", and then check the fault code display. Fault code number is not displayed → Service is finished. Fault code number is displayed → Refer to item 4.
4	Installed condition of sensor.	Check that the sensor is installed securely and that there are no pinched leads. Check that the ECU is installed securely and that there are no pinched leads. Incorrect installation → Reinstall or repair.	Set the switch on the FI diagnostic tool sub-wire harness to "ON", and then check the fault code display. Fault code number is not displayed → Service is finished. Fault code number is displayed → Refer to item 5.

FUEL INJECTION SYSTEM

Fault code No.	23		
Symptom	Atmospheric pressure sensor signal is not received properly.		
Fail-safe system	Able to start		
	Able to drive		
Diagnostic code No.	D02		
FI diagnostic tool display	Atmosphere		
Checking method	Measure the atmospheric pressure.		
Item	Item/components and probable cause	Check or maintenance job	Checking method
5	Defective atmospheric pressure sensor.	Execute the diagnostic mode (diagnostic code No. D02). When the engine is stopped, displays the atmospheric pressure according to the elevation and weather. 0 m above sea level: Approx. 101 kPa 1000 m above sea level: Approx. 90 kPa 2000 m above sea level: Approx. 80 kPa 3000 m above sea level: Approx. 70 kPa Displayed value is incorrect → Replace.	Set the switch on the FI diagnostic tool sub-wire harness to "ON", and then check the fault code display. Fault code number is not displayed → Service is finished. Fault code number is displayed → Refer to item 6.
6	Malfunction in ECU.	Replace the ECU.	

FUEL INJECTION SYSTEM

Fault code No.	30		
Symptom	Turnover of vehicle		
Fail-safe system	Able to start		
	Unable to drive		
Diagnostic code No.	D08		
FI diagnostic tool display	Lean angle sensor • 1.0 V (Upright) • 4.0 V (Overturned)		
Checking method	Remove the ECU and incline it 45° or more.		
Item	Item/components and probable cause	Check or maintenance job	Checking method
1	The vehicle has overturned.	Raise the vehicle upright.	Set the switch on the FI diagnostic tool sub-wire harness to "ON", and then check the fault code display. Fault code number is not displayed → Service is finished. Fault code number is displayed → Refer to item 2.
2	Installed condition of ECU. •Make sure that the installation position is correct.	Check that the sensor is installed securely and that there are no pinched leads. Check that the ECU is installed securely and that there are no pinched leads. Incorrect installation → Reinstall or repair. Incorrect installation position → Properly install.	Set the switch on the FI diagnostic tool sub-wire harness to "ON", and then check the fault code display. Fault code number is not displayed → Service is finished. Fault code number is displayed → Refer to item 3.
3	Defective lean angle sensor.	Execute the diagnostic mode (diagnostic code No. D30). Upright: 1.0 V Overturned: 4.0 V Displayed value is incorrect → Replace the ECU.	Set the switch on the FI diagnostic tool sub-wire harness to "ON", and then check the fault code display. Fault code number is not displayed → Service is finished. Fault code number is displayed → Refer to item 4.
4	Malfunction in ECU.	Replace the ECU.	

FUEL INJECTION SYSTEM

Fault code No.		33	
Symptom		Ignition system circuit signal is not received properly.	
Fail-safe system		Unable to start	
		Unable to drive	
Diagnostic code No.		D30	
FI diagnostic tool display		Actuates the ignition coil for five times every second. The "WARNING" LED on the FI diagnostic tool comes on each time the ignition coil is actuated.	
Checking method		Check the spark five times. • Connect an ignition checker.	
Item	Item/components and probable cause	Check or maintenance job	Checking method
1	Check the connection and locking condition of the ignition coil coupler. Disconnect the coupler and check the pins. (bent or broken terminals and locking condition of the pins)	Poor connection → Properly connect, repair, or replace.	Start the engine and let it idle for approximately 5 seconds. After completing the above operation, check whether a fault code number is displayed. Fault code number is not displayed → Service is finished. Fault code number is displayed → Refer to item 2.
2	Check the connection and locking condition of the wire harness ECU coupler. Disconnect the coupler and check the pins. (bent or broken terminals and locking condition of the pins)	Poor connection → Properly connect, repair, or replace.	Start the engine and let it idle for approximately 5 seconds. After completing the above operation, check whether a fault code number is displayed. Fault code number is not displayed → Service is finished. Fault code number is displayed → Refer to item 3.
3	Continuity of harness	Open or short circuit → Replace. Between Ignition coil coupler and ECU coupler. (Orange–Orange)	Start the engine and let it idle for approximately 5 seconds. After completing the above operation, check whether a fault code number is displayed. Fault code number is not displayed → Service is finished. Fault code number is displayed → Refer to item 4.

FUEL INJECTION SYSTEM

Fault code No.	33		
Symptom	Ignition system circuit signal is not received properly.		
Fail-safe system	Unable to start		
	Unable to drive		
Diagnostic code No.	D30		
FI diagnostic tool display	Actuates the ignition coil for five times every second. The "WARNING" LED on the FI diagnostic tool comes on each time the ignition coil is actuated.		
Checking method	Check the spark five times. • Connect an ignition checker.		
Item	Item/components and probable cause	Check or maintenance job	Checking method
4	Installed condition of ignition coil	Check that the sensor is installed securely and that there are no pinched leads. Check that the ECU is installed securely and that there are no pinched leads. Incorrect installation → Reinstall or repair.	Start the engine and let it idle for approximately 5 seconds. After completing the above operation, check whether a fault code number is displayed. Fault code number is not displayed → Service is finished. Fault code number is displayed → Refer to item 5.
5	Defective ignition coil. (test the primary coils for continuity)	Defective → Replace. Refer to "CHECKING THE IGNITION COIL".	Start the engine and let it idle for approximately 5 seconds. After completing the above operation, check whether a fault code number is displayed. Fault code number is not displayed → Service is finished. Fault code number is displayed → Refer to item 6.
6	Malfunction in ECU.	Execute the diagnostic mode (diagnostic code No. D30). No spark → Replace the ECU.	

FUEL INJECTION SYSTEM

Fault code No.	39		
Symptom	Injection system circuit signal is not received properly.		
Fail-safe system	Unable to start		
	Unable to drive		
Diagnostic code No.	D36		
FI diagnostic tool display	Actuates the injector for five times every second. The "WARNING" LED on the FI diagnostic tool comes on each time the fuel injector is actuated.		
Checking method	Check the operating sound of the injector five times.		
Item	Item/components and probable cause	Check or maintenance job	Checking method
1	Check the connection and locking condition of the fuel injector coupler. Disconnect the coupler and check the pins. (bent or broken terminals and locking condition of the pins)	Poor connection → Properly connect, repair, or replace.	Start the engine and let it idle for approximately 5 seconds. After completing the above operation, check whether a fault code number is displayed. Fault code number is not displayed → Service is finished. Fault code number is displayed → Refer to item 2.
2	Faulty injector	Defective → Replace. Refer to "CHECKING THE FUEL INJECTORS"	Start the engine and let it idle for approximately 5 seconds. After completing the above operation, check whether a fault code number is displayed. Fault code number is not displayed → Service is finished. Fault code number is displayed → Refer to item 3.
3	Check the connection and locking condition of the wire harness ECU coupler. Disconnect the coupler and check the pins. (bent or broken terminals and locking condition of the pins)	Poor connection → Properly connect, repair, or replace.	Start the engine and let it idle for approximately 5 seconds. After completing the above operation, check whether a fault code number is displayed. Fault code number is not displayed → Service is finished. Fault code number is displayed → Refer to item 4.

FUEL INJECTION SYSTEM

Fault code No.	39		
Symptom	Injection system circuit signal is not received properly.		
Fail-safe system	Unable to start		
	Unable to drive		
Diagnostic code No.	D36		
FI diagnostic tool display	Actuates the injector for five times every second. The "WARNING" LED on the FI diagnostic tool comes on each time the fuel injector is actuated.		
Checking method	Check the operating sound of the injector five times.		
Item	Item/components and probable cause	Check or maintenance job	Checking method
4	Continuity of harness	Open or short circuit → Replace. Between injector coupler and ECU coupler. (Red-Red) (Red/Black-Red/Black)	Start the engine and let it idle for approximately 5 seconds. After completing the above operation, check whether a fault code number is displayed. Fault code number is not displayed → Service is finished. Fault code number is displayed → Refer to item 5.
5	Malfunction in ECU.	Replace the ECU.	

Fault code No.	41		
Symptom	Lean angle sensor malfunction. (the sensor is built into the ECU)		
Fail-safe system	Unable to start		
	Unable to drive		
Diagnostic code No.	D08		
FI diagnostic tool display	Lean angle sensor • 1.0 V (Upright) • 4.0 V (Overturned)		
Checking method	Remove the ECU and incline it 45 ° or more.		
Item	Item/components and probable cause	Check or maintenance job	Checking method
1	Malfunction in ECU.	Replace the ECU.	

FUEL INJECTION SYSTEM

Fault code No.	44		
Symptom	Error is detected while reading or writing on EEPROM.		
Fail-safe system	Able to start engine (depending on circumstances)		
	Able to drive vehicle (depending on circumstances)		
Diagnostic code No.	D60		
FI diagnostic tool display	00: No fault 01: CO adjustment valve 07: Power Tuner adjustment values 0–8 for fuel injection amount or ignition timing		
Checking method	—		
Item	Item/components and probable cause	Check or maintenance job	Checking method
1	Determine the area of the problem	Execute the diagnostic mode (diagnostic code No. D60). 00 is displayed: Refer to item 4. 01 is displayed: Refer to item 2. 07 is displayed: Refer to item 3.	Set the switch on the FI diagnostic tool sub-wire harness to "ON", and then check the fault code display. Fault code number is not displayed → Service is finished. Fault code number is displayed → Repeat item 1. If the fault code number is still displayed, refer to item 3.
2	EEPROM data error (CO adjustment value)	Change the CO density and write the changed setting on EEPROM.	Set the switch on the FI diagnostic tool sub-wire harness to "ON", and then check the fault code display. Fault code number is not displayed → Service is finished. Fault code number is displayed → Repeat item 1. If the fault code number is still displayed, refer to item 4.
3	EEPROM data error (Power Tuner adjustment values for fuel injection amount or ignition timing)	Erase the setting map in the diagnostic mode (diagnostic code No. D65).	Set the switch on the FI diagnostic tool sub-wire harness to "ON", and then check the fault code display. Fault code number is not displayed → Service is finished. Fault code number is displayed → Refer to item 1.
4	Malfunction in ECU.	Replace the ECU.	

FUEL INJECTION SYSTEM

Fault code No.	46		
Symptom	Power supply to the ECU is not normal.		
Fail-safe system	Able to start (depending on circumstances)		
	Able to drive vehicle (depending on circumstances)		
Diagnostic code No.	—		
FI diagnostic tool display	—		
Checking method	—		
Item	Item/components and probable cause	Check or maintenance job	Checking method
1	Check the connection and locking condition of the ECU coupler. Disconnect the coupler and check the pins. (bent or broken terminals and locking condition of the pins)	Poor connection → Properly connect, repair, or replace.	Start the engine, set the switch on the FI diagnostic tool sub-wire harness to "OFF" while the engine is idling, and let the engine continue to idle for 5 seconds or more. After completing the above operation, check whether a fault code number is displayed. Fault code number is not displayed → Service is finished. Fault code number is displayed → Refer to item 2.
2	Continuity of harness	Open or short circuit → Replace. Between Rectifier/regulator and the ECU (Red-Red/White) Between Rectifier/regulator and the condenser. (Red-Red)	Start the engine, set the switch on the FI diagnostic tool sub-wire harness to "OFF" while the engine is idling, and let the engine continue to idle for 5 seconds or more. After completing the above operation, check whether a fault code number is displayed. Fault code number is not displayed → Service is finished. Fault code number is displayed → Refer to item 3.
3	Malfunction of the rectifier/regulator.	Defective → Replace. Refer to "CHECKING THE RECTIFIER/REGULATOR" section.	Start the engine, set the switch on the FI diagnostic tool sub-wire harness to "OFF" while the engine is idling, and let the engine continue to idle for 5 seconds or more. After completing the above operation, check whether a fault code number is displayed. Fault code number is not displayed → Service is finished. Fault code number is displayed → Refer to item 4.

FUEL INJECTION SYSTEM

Fault code No.	46		
Symptom	Power supply to the ECU is not normal.		
Fail-safe system	Able to start (depending on circumstances)		
	Able to drive vehicle (depending on circumstances)		
Diagnostic code No.	—		
FI diagnostic tool display	—		
Checking method	—		
Item	Item/components and probable cause	Check or maintenance job	Checking method
4	Defective AC magneto.	Defective → Replace. Refer to "CHECKING THE AC MAGNETO" section.	Start the engine, set the switch on the FI diagnostic tool sub-wire harness to "OFF" while the engine is idling, and let the engine continue to idle for 5 seconds or more. After completing the above operation, check whether a fault code number is displayed. Fault code number is not displayed → Service is finished. Fault code number is displayed → Refer to item 5.
5	Malfunction in ECU.	Replace the ECU.	

Fault code No.	50		
Symptom	ECU internal malfunction		
Fail-safe system	Unable to start		
	Unable to drive		
Diagnostic code No.	—		
FI diagnostic tool display	—		
Checking method	—		
Item	Item/components and probable cause	Check or maintenance job	Checking method
1	Malfunction in ECU.	Replace the ECU.	Set the switch on the FI diagnostic tool sub-wire harness to "ON", and then check the fault code display. Fault code number is not displayed → Service is finished.

FUEL INJECTION SYSTEM

Fault code No.	waiting for connection		
Symptom	Communication signal is not received.		
Fail-safe system	Able to start (unable when ECU is malfunctioning)		
	Able to drive vehicle (unable when ECU is malfunctioning)		
Diagnostic code No.	—		
FI diagnostic tool display	—		
Checking method	—		
Item	Item/components and probable cause	Check or maintenance job	Checking method
1	Check the connection and locking condition of the FI diagnostic tool coupler. Disconnect the coupler and check the pins. (bent or broken terminals and locking condition of the pins)	Poor connection → Properly connect, repair, or replace.	Set the switch on the FI diagnostic tool sub-wire harness to "ON", and then check the fault code display. Fault code number is not displayed → Service is finished. Fault code number is displayed → Refer to item 2.
2	Check the connection and locking condition of the wire harness ECU coupler. Disconnect the coupler and check the pins. (bent or broken terminals and locking condition of the pins)	Poor connection → Properly connect, repair, or replace.	Set the switch on the FI diagnostic tool sub-wire harness to "ON", and then check the fault code display. Fault code number is not displayed → Service is finished. Fault code number is displayed → Refer to item 3.
3	Continuity of harness	Open or short circuit → Replace. Between FI diagnostic tool coupler and ECU coupler. (Light green—Light green)	Set the switch on the FI diagnostic tool sub-wire harness to "ON", and then check the fault code display. Fault code number is not displayed → Service is finished. Fault code number is displayed → Refer to item 4.
4	FI diagnostic tool malfunction	Replace the FI diagnostic tool.	Set the switch on the FI diagnostic tool sub-wire harness to "ON", and then check the fault code display. Fault code number is not displayed → Service is finished. Fault code number is displayed → Refer to item 5.
5	Malfunction in ECU.	Replace the ECU.	

FUEL INJECTION SYSTEM

Fault code No.		Er-4	
Symptom		Registered data cannot be received from the FI diagnostic tool.	
Fail-safe system		Able to start	
		Able to drive	
Diagnostic code No.		—	
FI diagnostic tool display		—	
Checking method		—	
Item	Item/components and probable cause	Check or maintenance job	Checking method
1	Check the connection and locking condition of the FI diagnostic tool coupler. Disconnect the coupler and check the pins. (bent or broken terminals and locking condition of the pins)	Poor connection → Properly connect, repair, or replace.	Set the switch on the FI diagnostic tool sub-wire harness to "ON", and then check the fault code display. Fault code number is not displayed → Service is finished. Fault code number is displayed → Refer to item 2.
2	Check the connection and locking condition of the wire harness ECU coupler. Disconnect the coupler and check the pins. (bent or broken terminals and locking condition of the pins)	Poor connection → Properly connect, repair, or replace.	Set the switch on the FI diagnostic tool sub-wire harness to "ON", and then check the fault code display. Fault code number is not displayed → Service is finished. Fault code number is displayed → Refer to item 3.
3	Continuity of harness	Open or short circuit → Replace. Between FI diagnostic tool coupler and ECU coupler. (Light green—Light green)	Set the switch on the FI diagnostic tool sub-wire harness to "ON", and then check the fault code display. Fault code number is not displayed → Service is finished. Fault code number is displayed → Refer to item 4.
4	FI diagnostic tool malfunction	Replace the FI diagnostic tool.	Set the switch on the FI diagnostic tool sub-wire harness to "ON", and then check the fault code display. Fault code number is not displayed → Service is finished. Fault code number is displayed → Refer to item 5.
5	Malfunction in ECU.	Replace the ECU.	

FUEL PUMP SYSTEM

FUEL PUMP SYSTEM

INSPECTION STEPS

If the fuel pump is not operating normally, perform the following procedures in the order given.

Check engine stop switch.	No good →	Replace.
OK ↓		
Checking the couplers and leads connections	No good →	Repair or replace.
OK ↓		
Check the fuel pump.(Checking the fuel pump body)	No good →	Replace the fuel pump assembly.
OK ↓		
Replace the ECU.		

TIP

- Remove the following parts before inspection.
 1. Seat
 2. Side cover (right/left)
 3. Fuel tank
- Use the following special tools in this inspection.

	Pocket tester: YU-03112-C/90890-03112 Test harness S-pressure sensor (3P): YU-03207/90890-03207
---	--

ELECTRICAL COMPONENTS

CHECKING THE COOLANT TEMPERATURE SENSOR

1. Remove:

- Coolant temperature sensor
Refer to "REMOVING THE CYLINDER HEAD" section in the CHAPTER 4.

⚠ WARNING

- Handle the coolant temperature sensor with special care.
- Never subject the coolant temperature sensor to strong shocks. If the coolant temperature sensor is dropped, replace it.

2. Check:

- Coolant temperature sensor resistance

3. Connect:

- Tester
Tester (+) lead → Brown lead "1"
Tester (-) lead → Black/Blue lead "2"

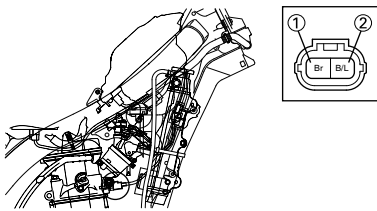

4. Immerse the coolant temperature sensor in a container filled with coolant.

TIP

Make sure the coolant temperature sensor terminals do not get wet.

5. Place a thermometer "3" in the coolant.

6. Slowly heat the coolant, and then let it cool to the specified temperature indicated in the table.

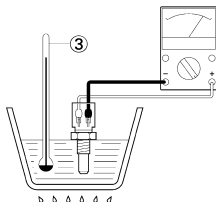

	Coolant temperature sensor resistance	Tester selector position
	210–220 Ω (100°C, 212°F)	Ω ×100
	2.51–2.78 kΩ (20°C, 68°F)	kΩ ×1

Out of specification → Replace.

CHECKING THE INTAKE AIR PRESSURE SENSOR

1. Check:

- Intake air pressure sensor output voltage

2. Connect:

- Test harness S–pressure sensor (3P) "1"
- Tester
Tester (+) lead → Pink/White lead (wire harness color)
Tester (-) lead → Black/Blue lead (wire harness color)

	Test harness S–pressure sensor (3P) YU-03207/90890-03207
--	---

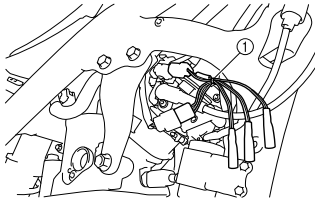

3. Connect the FI diagnostic tool sub-wire harness to a battery, and then set the switch on the harness to "ON".

NOTICE

When checking the intake air pressure sensor, do not start the engine.

4. Measure the intake air pressure sensor output voltage.

	Output voltage	Tester selector position
	3.4–3.8 V	DCV

Out of specification → Replace

CHECKING THE INTAKE AIR TEMPERATURE SENSOR

1. Remove:

- Intake air temperature sensor (from the air filter case.)

⚠ WARNING

- Handle the intake air temperature sensor with special care.
- Never subject the intake air temperature sensor to strong shocks. If the intake air temperature sensor is dropped, replace it.

2. Check:

- Intake air temperature sensor resistance

3. Connect:

- Tester
Tester (+) lead → Brown/White lead "1"
Tester (-) lead → Black/Blue lead (wire harness color) "2"

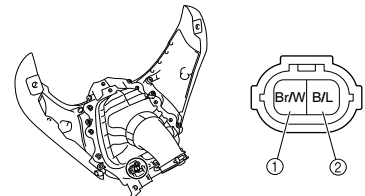

	Intake air temperature sensor resistance	Tester selector position
	5.4–6.6 kΩ (0°C, 32°F)	kΩ ×1
	290–390 Ω (80°C, 176°F)	Ω ×100

Out of specification → Replace.

CHECKING THE ATMOSPHERIC PRESSURE SENSOR

1. Check:

- Atmospheric pressure sensor output voltage

2. Connect:

- Test harness S–pressure sensor (3P) "1"
- Tester
Tester (+) lead → Pink lead (wire harness color)
Tester (-) lead → Black/Blue lead (wire harness color)

	Test harness S–pressure sensor (3P): YU-03207/90890-03207
---	--

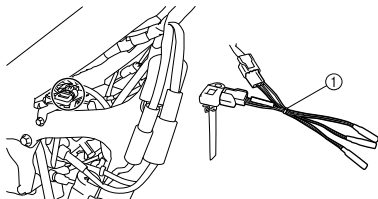

3. Connect the FI diagnostic tool sub-wire harness to a battery, and then set the switch on the harness to "ON".

NOTICE

When checking the atmospheric pressure sensor, do not start the engine.

4. Measure the atmospheric pressure sensor output voltage.

	Output voltage	Tester selector position
	3.4–3.8 V	DCV

Out of specification → Replace.

CHECKING THE RECTIFIER/REGULATOR

1. Connect:

- Connect the tester to the coupler for connecting optional part
Tester (+) lead → Red lead "1"
Tester (-) lead → Black/White lead "2"

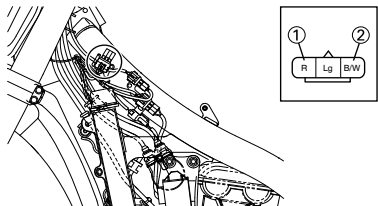

2. Start the engine.

3. Check:

- Rectifier/regulator output voltage

	Output voltage	Tester selector position
	14.1–14.9 V	DCV

Out of specification → Replace.

4. Stop the engine.

CHECKING THE FUEL INJECTORS

1. Remove:

- Seat
- Fuel tank
- Air filter case

2. Check:

- Injector resistance

3. Connect:

- Tester
Tester (+) lead → Injector terminal "1"
Tester (-) lead → Injector terminal "2"

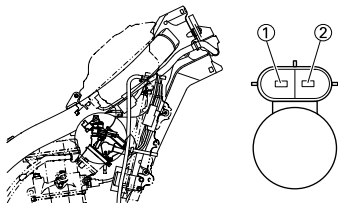

	Injector resistance	Tester selector position
	12.0 Ω (20°C, 68°F)	Ω ×10

Out of specification → Replace.

TUNING CHASSIS

SELECTION OF THE SECONDARY REDUCTION RATIO (SPROCKET)

Secondary reduction ratio = Number of rear wheel sprocket teeth/Number of drive sprocket teeth	
Standard secondary reduction ratio	3.692 (48/13) * 3.769 (49/13)

* Except for USA and CDN

<Requirement for selection of secondary gear reduction ratio>

- It is generally said that the secondary gear ratio should be reduced for a longer straight portion of a speed course and should be increased for a course with many corners. Actually, however, as the speed depends on the ground condition of the day of the race, be sure to run through the circuit to set the machine suitable for the entire course.
- In actuality, it is very difficult to achieve settings suitable for the entire course and some settings may be sacrificed. Thus, the settings should be matched to the portion of the course that has the greatest effect on the race result. In such a case, run through the entire course while making notes of lap times to find the best balance; then, determine the secondary reduction ratio.
- If a course has a long straight portion where a machine can run at maximum speed, the machine is generally set such that it can develop its maximum revolutions toward the end of the straight line, with care taken to avoid the engine over-revving.

TIP

Riding technique varies from rider to rider and the performance of a machine also vary from machine to machine. Therefore, do not imitate other rider's settings from the beginning but choose your own setting according to the level of your riding technique.

DRIVE AND REAR WHEEL SPROCKETS SETTING PARTS

Part name	Size	Part number
Drive sprocket "1"	(STD)	13T 9383E-13233
Rear wheel sprocket "2"	47T	17D-25447-50
	(STD)	48T 17D-25448-50
	* (STD)	49T 17D-25449-50
	50T	17D-25450-50
	51T	17D-25451-50
	52T	17D-25452-50

* Except for USA and CDN

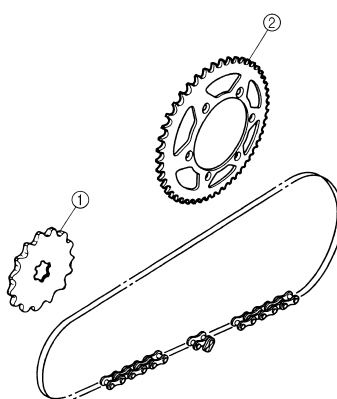

TIRE PRESSURE

Tire pressure should be adjusted to suit the road surface condition of the circuit.

	Standard tire pressure: 100 kPa (1.0 kgf/cm², 15 psi)
--	---

- Under a rainy, muddy, sandy, or slippery condition, the tire pressure should be lower for a larger area of contact with the road surface.

	Extent of adjustment: 60–80 kPa (0.6–0.8 kgf/cm², 9.0–12 psi)
--	---

- Under a stony or hard road condition, the tire pressure should be higher to prevent a flat tire.

	Extent of adjustment: 100–120 kPa (1.0–1.2 kgf/cm², 15–18 psi)
--	--

FRONT FORK SETTING

The front fork setting should be made depending on the rider's feeling of an actual run and the circuit conditions. The front fork setting includes the following three factors:

- Setting of air spring characteristics
 - Change the fork oil amount.
- Setting of spring preload
 - Change the spring.
- Setting of damping force
 - Change the compression damping.
 - Change the rebound damping.

The spring acts on the load and the damping force acts on the cushion travel speed.

CHANGE IN AMOUNT AND CHARACTERISTICS OF FORK OIL

Damping characteristic near the final stroke can be changed by changing the fork oil amount.

⚠ WARNING

Adjust the oil amount in 5 cm³ (0.2 Imp oz, 0.2 US oz) increments or decrements. Too small oil amount causes the front fork to produce a noise at full rebound or the rider to feel some pressure on his hands or body. Alternatively, too large oil amount will cause the air spring characteristics to have a tendency to be stiffer with the consequent deteriorated performance and characteristics. Therefore, adjust the front fork within the specified range.

	Standard oil amount: 355 cm³ (12.5 Imp oz, 12.0 US oz) Extent of adjustment: 300–365 cm³ (10.6–12.8 Imp oz, 10.1–12.3 US oz)
--	---

A

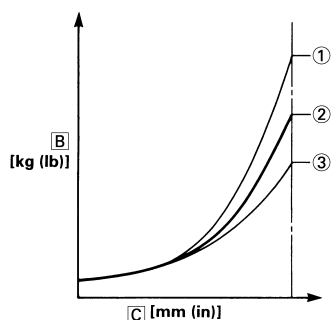

- A. Air spring characteristics in relation to oil amount change
- B. Load
- C. Stroke
1. Max. oil amount
 2. Standard oil amount
 3. Min. oil amount

SETTING OF SPRING AFTER REPLACEMENT

As the front fork setting can be easily affected by rear suspension, take care so that the machine front and rear are balanced (in position, etc.) when setting the front fork.

1. Use of soft spring
 - Change the rebound damping. Turn out one or two clicks.
 - Change the compression damping. Turn in one or two clicks.

TIP

Generally a soft spring gives a soft riding feeling. Rebound damping tends to become stronger and the front fork may sink deeply over a series of gaps.

2. Use of stiff spring
 - Change the rebound damping. Turn in one or two clicks.
 - Change the compression damping. Turn out one or two clicks.

TIP

Generally a stiff spring gives a stiff riding feeling. Rebound damping tends to become weaker, resulting in lack of a sense of contact with the road surface or in a vibrating handlebar.

FRONT FORK SETTING PARTS

- Front fork spring "1"

TYPE	SPRING RATE	SPRING PART NUMBER	I.D. MARK (slits)
SOFT	0.459	33D-23141-20	I-II
STANDARD	0.469	33D-23141-30 33D-23141-D0	I-III —
STIFF	0.479	33D-23141-40	I-IV

TIP

The I.D. mark (slits) "a" is proved on the end of the spring.

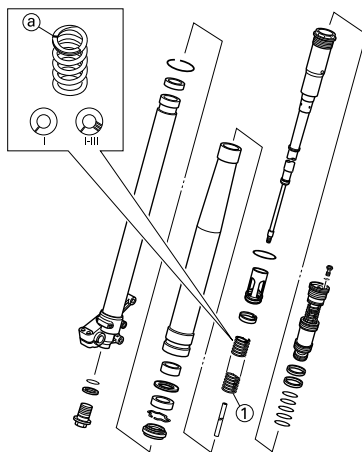

REAR SUSPENSION SETTING

The rear suspension setting should be made depending on the rider's feeling of an actual run and the circuit conditions.

The rear suspension setting includes the following two factors:

1. Setting of spring preload
 - Change the set length of the spring.
 - Change the spring.
2. Setting of damping force
 - Change the rebound damping.
 - Change the compression damping.

CHOOSING SET LENGTH

1. Place a stand or block under the engine to put the rear wheel above the floor, and measure the length "a" between the rear wheel axle center and the rear fender holding bolt.

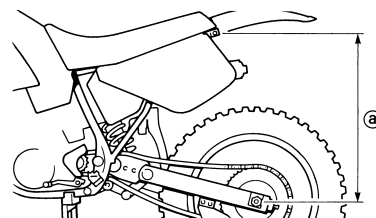

2. Remove the stand or block from the engine and with a rider astride the seat, measure the sunken length "b" between the rear wheel axle center and the rear fender holding bolt.

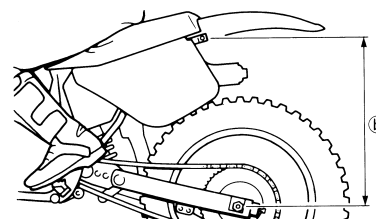

3. Loosen the locknut "1" and make adjustment by turning the spring adjuster "2" to achieve the standard figure from the subtraction of the length "b" from the length "a".

Standard figure:
90–100 mm (3.5–3.9 in)

TIP

- If the machine is new and after it is broken in, the same set length of the spring may change because of the initial fatigue, etc. of the spring. Therefore, be sure to make reevaluation.
- If the standard figure cannot be achieved by adjusting the spring adjuster and changing the spring set length, replace the spring with an optional one and make readjustment.

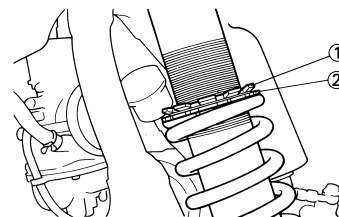

SETTING OF SPRING AFTER REPLACEMENT

After replacement, be sure to adjust the spring to the set length [sunken length 90–100 mm (3.5–3.9 in)] and set it.

1. Use of soft spring
 - Set the soft spring for less rebound damping to compensate for its less spring load. Run with the rebound damping adjuster one or two clicks on the softer side and readjust it to suit your preference.
2. Use of stiff spring
 - Set the soft spring for more rebound damping to compensate for its greater spring load. Run with the rebound damping adjuster one or two clicks on the stiffer side and readjust it to suit your preference.

TIP

Adjusting the rebound damping will be followed more or less by a change in the compression damping. For correction, turn the low compression damping adjuster on the softer side.

⚠ WARNING

When using a rear shock absorber other than currently installed, use the one whose overall length "a" does not exceed the standard as it may result in faulty performance. Never use one whose overall length is greater than standard.

 Length "a" of standard shock:
459 mm (18.07 in)

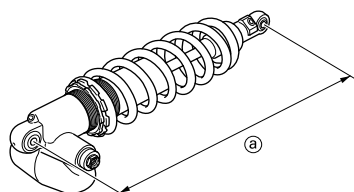

REAR SHOCK ABSORBER SETTING PARTS

- Rear shock spring "1"

TYPE	SPRING RATE	SPRING PART NUMBER (-22212-)	I.D. MARK
SOFT	5.3	33D-10	Yellow
		(Blue)	
		33D-B0	
		(Red)	
* STD	5.5	33D-20	Pink
		(Blue)	
		33D-C0	
		(Red)	
STD	5.7	33D-30	White
		(Blue)	
		33D-D0	
		(Red)	
STIFF	5.9	33D-40	Silver
		(Blue)	
		33D-E0	
		(Red)	

* Except for USA and CDN

TIP

- The I.D. mark "a" is marked at the end of the spring.
- Spring specification varies according to the color and quantity of I.D. marks.

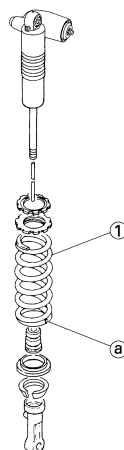

- Extent of adjustment (spring preload)

SPRING PART NUMBER (-22212-)	Maximum	Minimum
33D-10 33D-20 33D-30 33D-40 33D-B0 33D-C0 33D-D0 33D-E0	Position in which the spring is turned in 18 mm (0.71 in) from its free length.	Position in which the spring is turned in 1.5 mm (0.06 in) from its free length.

TIP

For the spring preload adjustment, refer to "ADJUSTING THE REAR SHOCK ABSORBER SPRING PRELOAD" in the CHAPTER 3.

SUSPENSION SETTING (FRONT FORK)

TIP

- If any of the following symptoms is experienced with the standard position as the base, make resetting by reference to the adjustment procedure given in the same chart.
- Before any change, set the rear shock absorber sunken length to the standard figure 90–100 mm (3.5–3.9 in).

Symptom	Section				Check	Adjust
	Jump	Large gap	Medium gap	Small gap		
Stiff over entire range	○	○	○		Compression damping	Turn adjuster counterclockwise (about 2 clicks) to decrease damping.
					Oil amount	Decrease oil amount by about 5–10 cm ³ (0.2–0.4 Imp oz, 0.2–0.3 US oz).
					Spring	Replace with soft spring.
Unsmooth movement over entire range	○	○	○	○	Outer tube	Check for any bends, dents, and other noticeable scars, etc. If any, replace affected parts.
					Inner tube	
					Slide metal	Replace with a new one for extended use.
					Piston metal	Replace with a new one for extended use.
					Under bracket tightening torque	Retighten to specified torque.
Poor initial movement				○	Rebound damping	Turn adjuster counterclockwise (about 2 clicks) to decrease damping.
					Oil seal	Apply grease in oil seal wall.
Soft over entire range, bottoming out	○	○			Compression damping	Turn adjuster clockwise (about 2 clicks) to increase damping.
					Oil amount	Increase oil amount by about 5–10 cm ³ (0.2–0.4 Imp oz, 0.2–0.3 US oz).
					Spring	Replace with stiff spring.
Stiff toward stroke end	○				Oil amount	Decrease oil amount by about 5 cm ³ (0.2 Imp oz, 0.2 US oz).
Soft toward stroke end, bottoming out	○				Oil amount	Increase oil amount by about 5 cm ³ (0.2 Imp oz, 0.2 US oz).
Stiff initial movement	○	○	○	○	Compression damping	Turn adjuster counterclockwise (about 2 clicks) to decrease damping.
Low front, tending to lower front posture			○	○	Compression damping	Turn adjuster clockwise (about 2 clicks) to increase damping.
					Rebound damping	Turn adjuster counterclockwise (about 2 clicks) to decrease damping.
					Balance with rear end	Set sunken length for 95–100 mm (3.7–3.9 in) when one passenger is astride seat (lower rear posture).
					Oil amount	Increase oil amount by about 5 cm ³ (0.2 Imp oz, 0.2 US oz).
"Obtrusive" front, tending to upper front posture			○	○	Compression damping	Turn adjuster counterclockwise (about 2 clicks) to decrease damping.
					Balance with rear end	Set sunken length for 90–95 mm (3.5–3.7 in) when one passenger is astride seat (upper rear posture).
					Spring	Replace with soft spring.
					Oil amount	Decrease oil amount by about 5–10 cm ³ (0.2–0.4 Imp oz, 0.2–0.3 US oz).

SUSPENSION SETTING (REAR SHOCK ABSORBER)

TIP

- If any of the following symptoms is experienced with the standard position as the base, make resetting by reference to the adjustment procedure given in the same chart.
- Adjust the rebound damping in 2-click increments or decrements.
- Adjust the low compression damping in 1-click increments or decrements.
- Adjust the high compression damping in 1/6 turn increments or decrements.

Symptom	Section				Check	Adjust
	Jump	Large gap	Medium gap	Small gap		
Stiff, tending to sink			○	○	Rebound damping	Turn adjuster counterclockwise (about 2 clicks) to decrease damping.
					Spring set length	Set sunken length for 90–100 mm (3.5–3.9 in) when one passenger is astride seat.
Spongy and unstable			○	○	Rebound damping	Turn adjuster clockwise (about 2 clicks) to increase damping.
					Low compression damping	Turn adjuster clockwise (about 1 click) to increase damping.
					Spring	Replace with stiff spring.
Heavy and dragging			○	○	Rebound damping	Turn adjuster counterclockwise (about 2 clicks) to decrease damping.
					Spring	Replace with soft spring.
Poor road gripping				○	Rebound damping	Turn adjuster counterclockwise (about 2 clicks) to decrease damping.
					Low compression damping	Turn adjuster clockwise (about 1 clicks) to increase damping.
					High compression damping	Turn adjuster clockwise (about 1/6 turn) to increase damping.
					Spring set length	Set sunken length for 90–100 mm (3.5–3.9 in) when one passenger is astride seat.
					Spring	Replace with soft spring.
Bottoming out	○	○			High compression damping	Turn adjuster clockwise (about 1/6 turn) to increase damping.
					Spring set length	Set sunken length for 90–100 mm (3.5–3.9 in) when one passenger is astride seat.
					Spring	Replace with stiff spring.
Bouncing	○	○			Rebound damping	Turn adjuster clockwise (about 2 clicks) to increase damping.
					Spring	Replace with soft spring.
Stiff travel	○	○			High compression damping	Turn adjuster counterclockwise (about 1/6 turn) to decrease damping.
					Spring set length	Set sunken length for 90–100 mm (3.5–3.9 in) when one passenger is astride seat.
					Spring	Replace with soft spring.

