



OWNER'S MANUAL

*Virago*

**XV250W**

2UJ-28199-24



Welcome to the Yamaha world of motorcycling!

As the owner of the XV250W, you are benefiting from Yamaha's vast experience and newest technology regarding the design and manufacture of high-quality products, which have earned Yamaha a reputation for dependability.

Please take the time to read this manual thoroughly, so as to enjoy all advantages of your XV250W. The owner's manual does not only instruct you in how to operate, inspect and maintain your motorcycle, but also in how to safeguard yourself and others from trouble and injury.

In addition, the many tips given in this manual will help keep your motorcycle in the best possible condition. If you have any further questions, do not hesitate to contact your Yamaha dealer.

The Yamaha team wishes you many safe and pleasant rides. So, remember to put safety first!

# IMPORTANT MANUAL INFORMATION

---

---

EAU10151

Particularly important information is distinguished in this manual by the following notations:

	<b>The Safety Alert Symbol means ATTENTION! BECOME ALERT! YOUR SAFETY IS INVOLVED!</b>
	<b>Failure to follow WARNING instructions could result in severe injury or death to the motorcycle operator, a bystander, or a person inspecting or repairing the motorcycle.</b>
<b>CAUTION:</b>	<b>A CAUTION indicates special precautions that must be taken to avoid damage to the motorcycle.</b>
<b>NOTE:</b>	A NOTE provides key information to make procedures easier or clearer.

## NOTE:

- This manual should be considered a permanent part of this motorcycle and should remain with it even if the motorcycle is subsequently sold.
- Yamaha continually seeks advancements in product design and quality. Therefore, while this manual contains the most current product information available at the time of printing, there may be minor discrepancies between your motorcycle and this manual. If you have any questions concerning this manual, please consult your Yamaha dealer.

EWA10030

## **WARNING**

**PLEASE READ THIS MANUAL CAREFULLY AND COMPLETELY BEFORE OPERATING THIS MOTORCYCLE.**

---

\*Product and specifications are subject to change without notice.

# IMPORTANT MANUAL INFORMATION

---

---

EAU10200

**XV250W  
OWNER'S MANUAL  
©2006 by Yamaha Motor Co., Ltd.  
1st edition, May 2006  
All rights reserved.  
Any reprinting or unauthorized use  
without the written permission of  
Yamaha Motor Co., Ltd.  
is expressly prohibited.  
Printed in Japan.**

# TABLE OF CONTENTS

---

---

<b>SAFETY INFORMATION</b> .....	1-1	<b>PRE-OPERATION CHECKS</b> .....	4-1	Spoke wheels .....	6-14
Location of important labels .....	1-5	Pre-operation check list .....	4-2	Adjusting the clutch lever free play .....	6-14
<b>DESCRIPTION</b> .....	2-1	<b>OPERATION AND IMPORTANT</b>		Adjusting the brake lever free play .....	6-15
Left view .....	2-1	<b>RIDING POINTS</b> .....	5-1	Adjusting the brake pedal position and free play .....	6-16
Right view .....	2-2	Starting and warming up a cold engine .....	5-1	Adjusting the rear brake light switch .....	6-17
Controls and instruments.....	2-3	Starting a warm engine .....	5-2	Checking the front brake pads and rear brake shoes .....	6-18
<b>INSTRUMENT AND CONTROL</b>		Shifting .....	5-2	Checking the front brake fluid level .....	6-18
<b>FUNCTIONS</b> .....	3-1	Tips for reducing fuel consumption .....	5-3	Changing the brake fluid .....	6-19
Main switch .....	3-1	Engine break-in .....	5-3	Drive chain slack .....	6-20
Indicator lights .....	3-1	Parking .....	5-4	Cleaning and lubricating the drive chain .....	6-22
Speedometer unit .....	3-2	<b>PERIODIC MAINTENANCE AND</b>		Checking and lubricating the cables .....	6-22
Handlebar switches .....	3-2	<b>MINOR REPAIR</b> .....	6-1	Checking and lubricating the throttle grip and cable .....	6-23
Clutch lever .....	3-3	Owner's tool kit .....	6-1	Checking and lubricating the brake and shift pedals .....	6-23
Shift pedal .....	3-4	Periodic maintenance and lubrication chart .....	6-2	Checking and lubricating the brake and clutch levers .....	6-23
Brake lever .....	3-4	Removing and installing the panel .....	6-5	Checking and lubricating the sidestand .....	6-24
Brake pedal .....	3-4	Checking the spark plugs .....	6-5	Lubricating the swingarm pivots .....	6-24
Fuel tank cap .....	3-5	Engine oil and oil filter element .....	6-7	Checking the front fork .....	6-24
Fuel .....	3-5	Cleaning the air filter element .....	6-9	Checking the steering .....	6-25
Fuel cock .....	3-6	Adjusting the carburetor .....	6-11		
Starter (choke) lever .....	3-7	Adjusting the engine idling speed .....	6-11		
Steering lock .....	3-8	Checking the throttle cable free play .....	6-12		
Rider seat .....	3-8	Valve clearance .....	6-12		
Helmet holder .....	3-9	Tires .....	6-12		
Adjusting the shock absorber assemblies .....	3-9				
Sidestand .....	3-10				
Ignition circuit cut-off system .....	3-11				

# TABLE OF CONTENTS

---

---

Checking the wheel bearings .....	6-26
Battery .....	6-26
Replacing the fuses .....	6-28
Replacing the headlight bulb .....	6-28
Replacing the tail/brake light bulb .....	6-30
Replacing a turn signal light bulb .....	6-30
Supporting the motorcycle .....	6-31
Front wheel .....	6-32
Rear wheel .....	6-33
Troubleshooting .....	6-35
Troubleshooting chart .....	6-36

## **MOTORCYCLE CARE AND**

<b>STORAGE</b> .....	7-1
Care .....	7-1
Storage .....	7-3

## **SPECIFICATIONS** .....

8-1

## **CONSUMER INFORMATION**.....

9-1

Identification numbers .....	9-1
Motorcycle noise regulation (for Australia) .....	9-2

# SAFETY INFORMATION

EAU10251

1

MOTORCYCLES ARE SINGLE TRACK VEHICLES. THEIR SAFE USE AND OPERATION ARE DEPENDENT UPON THE USE OF PROPER RIDING TECHNIQUES AS WELL AS THE EXPERTISE OF THE OPERATOR. EVERY OPERATOR SHOULD KNOW THE FOLLOWING REQUIREMENTS BEFORE RIDING THIS MOTORCYCLE.

HE OR SHE SHOULD:

- OBTAIN THOROUGH INSTRUCTIONS FROM A COMPETENT SOURCE ON ALL ASPECTS OF MOTORCYCLE OPERATION.
- OBSERVE THE WARNINGS AND MAINTENANCE REQUIREMENTS IN THE OWNER'S MANUAL.
- OBTAIN QUALIFIED TRAINING IN SAFE AND PROPER RIDING TECHNIQUES.
- OBTAIN PROFESSIONAL TECHNICAL SERVICE AS INDICATED BY THE OWNER'S MANUAL

AND/OR WHEN MADE NECESSARY BY MECHANICAL CONDITIONS.

## Safe riding

- Always make pre-operation checks. Careful checks may help prevent an accident.
- This motorcycle is designed to carry the operator and a passenger.
- The failure of motorists to detect and recognize motorcycles in traffic is the predominating cause of automobile/motorcycle accidents. Many accidents have been caused by an automobile driver who did not see the motorcycle. Making yourself conspicuous appears to be very effective in reducing the chance of this type of accident.

## Therefore:

- Wear a brightly colored jacket.
- Use extra caution when approaching and passing through intersections, since intersections are the most likely places for motorcycle accidents to occur.

- Ride where other motorists can see you. Avoid riding in another motorist's blind spot.
- Many motorcycle accidents involve inexperienced operators. In fact, many operators who have been involved in accidents do not even have a current motorcycle license.
- Make sure that you are qualified and that you only lend your motorcycle to other qualified operators.
- Know your skills and limits. Staying within your limits may help you to avoid an accident.
- We recommend that you practice riding your motorcycle where there is no traffic until you have become thoroughly familiar with the motorcycle and all of its controls.
- Many motorcycle accidents have been caused by error of the motorcycle operator. A typical error made by the operator is veering



wide on a turn due to EXCESSIVE SPEED or undercornering (insufficient lean angle for the speed).

- Always obey the speed limit and never travel faster than warranted by road and traffic conditions.
- Always signal before turning or changing lanes. Make sure that other motorists can see you.
- The posture of the operator and passenger is important for proper control.
  - The operator should keep both hands on the handlebar and both feet on the operator footrests during operation to maintain control of the motorcycle.
  - The passenger should always hold onto the operator, seat strap, or grab bar, if equipped, with both hands and keep both feet on the passenger footrests.
  - Never carry a passenger unless he or she can firmly place both feet on the passenger footrests.
- Never ride under the influence of alcohol or other drugs.

- This motorcycle is designed for on-road use only, therefore, it is not suitable for off-road use.

### **Protective apparel**

The majority of fatalities from motorcycle accidents are the result of head injuries. The use of a safety helmet is the single most critical factor in the prevention or reduction of head injuries.

- Always wear an approved helmet.
- Wear a face shield or goggles. Wind in your unprotected eyes could contribute to an impairment of vision which could delay seeing a hazard.
- The use of a jacket, heavy boots, trousers, gloves, etc., is effective in preventing or reducing abrasions or lacerations.
- Never wear loose-fitting clothes, otherwise they could catch on the control levers, footrests, or wheels and cause injury or an accident.
- Never touch the engine or exhaust system during or after operation. They become very hot and can

cause burns. Always wear protective clothing that covers your legs, ankles, and feet.

- Passengers should also observe the precautions mentioned above.

### **Modifications**

Modifications made to this motorcycle not approved by Yamaha, or the removal of original equipment, may render the motorcycle unsafe for use and may cause severe personal injury. Modifications may also make your motorcycle illegal to use.

### **Loading and accessories**

Adding accessories or cargo to your motorcycle can adversely affect stability and handling if the weight distribution of the motorcycle is changed. To avoid the possibility of an accident, use extreme caution when adding cargo or accessories to your motorcycle. Use extra care when riding a motorcycle that has added cargo or accessories. Here are some general guidelines to follow if loading cargo or adding accessories to your motorcycle:

# SAFETY INFORMATION

## Loading

The total weight of the operator, passenger, accessories and cargo must not exceed the maximum load limit.

**Maximum load:**  
196 kg (432 lb)

When loading within this weight limit, keep the following in mind:

- Cargo and accessory weight should be kept as low and close to the motorcycle as possible. Make sure to distribute the weight as evenly as possible on both sides of the motorcycle to minimize imbalance or instability.
- Shifting weights can create a sudden imbalance. Make sure that accessories and cargo are securely attached to the motorcycle before riding. Check accessory mounts and cargo restraints frequently.
- Never attach any large or heavy items to the handlebar, front fork, or front fender. These items, including such cargo as sleeping

bags, duffel bags, or tents, can create unstable handling or slow steering response.

## Accessories

Genuine Yamaha accessories have been specifically designed for use on this motorcycle. Since Yamaha cannot test all other accessories that may be available, you must personally be responsible for the proper selection, installation and use of non-Yamaha accessories. Use extreme caution when selecting and installing any accessories.

Keep the following guidelines in mind, as well as those provided under “Loading” when mounting accessories.

- Never install accessories or carry cargo that would impair the performance of your motorcycle. Carefully inspect the accessory before using it to make sure that it does not in any way reduce ground clearance or cornering clearance,

limit suspension travel, steering travel or control operation, or obscure lights or reflectors.

- Accessories fitted to the handlebar or the front fork area can create instability due to improper weight distribution or aerodynamic changes. If accessories are added to the handlebar or front fork area, they must be as lightweight as possible and should be kept to a minimum.
- Bulky or large accessories may seriously affect the stability of the motorcycle due to aerodynamic effects. Wind may attempt to lift the motorcycle, or the motorcycle may become unstable in cross winds. These accessories may also cause instability when passing or being passed by large vehicles.
- Certain accessories can displace the operator from his or her normal riding position. This improper position limits the freedom of movement of the opera-

tor and may limit control ability, therefore, such accessories are not recommended.

- Use caution when adding electrical accessories. If electrical accessories exceed the capacity of the motorcycle's electrical system, an electric failure could result, which could cause a dangerous loss of lights or engine power.

### **Gasoline and exhaust gas**

- **GASOLINE IS HIGHLY FLAMMABLE:**
  - Always turn the engine off when refueling.
  - Take care not to spill any gasoline on the engine or exhaust system when refueling.
  - Never refuel while smoking or in the vicinity of an open flame.
- Never start the engine or let it run for any length of time in a closed area. The exhaust fumes are poisonous and may cause loss of consciousness and death within a short time. Always operate your motorcycle in an area that has adequate ventilation.

- Always turn the engine off before leaving the motorcycle unattended and remove the key from the main switch. When parking the motorcycle, note the following:
  - The engine and exhaust system may be hot, therefore, park the motorcycle in a place where pedestrians or children are not likely to touch these hot areas.
  - Do not park the motorcycle on a slope or soft ground, otherwise it may fall over.
  - Do not park the motorcycle near a flammable source (e.g. a kerosene heater, or near an open flame), otherwise it could catch fire.
- When transporting the motorcycle in another vehicle, make sure that it is kept upright and that the fuel cock is turned to "ON" or "RES" (for vacuum type) / "OFF" (for manual type). If it should lean over, gasoline may leak out of the carburetor or fuel tank.
- If you should swallow any gasoline, inhale a lot of gasoline vapor, or allow gasoline to get into your

eyes, see your doctor immediately. If any gasoline spills on your skin or clothing, immediately wash the affected area with soap and water and change your clothes.

# SAFETY INFORMATION

EAU10381



## Location of important labels

Please read the following important labels carefully before operating this vehicle.

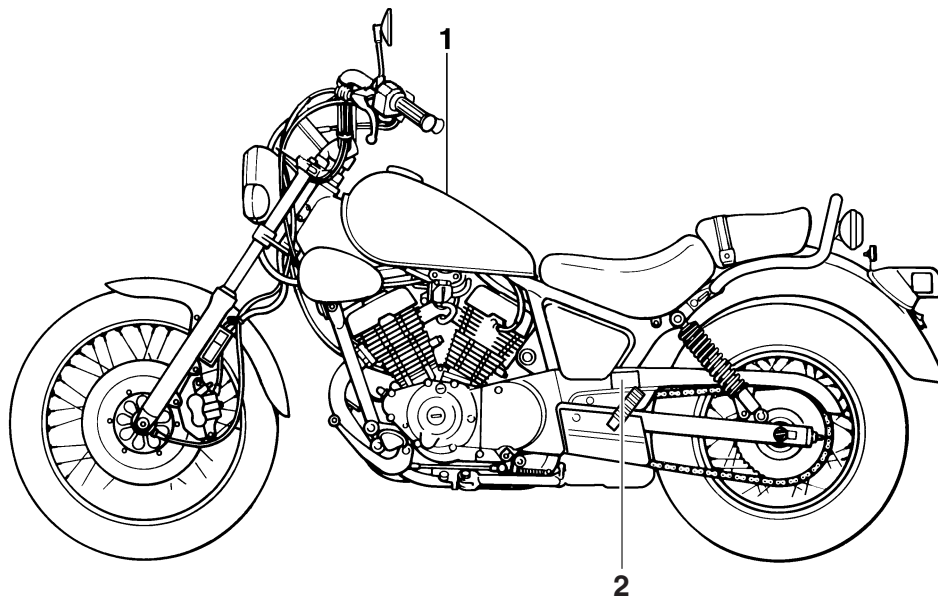
1



1

	<ul style="list-style-type: none"><li>• Before you operate this vehicle, read the owner's manual.</li><li>• Prima di usare il veicolo, leggete il manuale di istruzioni.</li><li>• Lire le manuel du propriétaire avant d'utiliser ce véhicule.</li><li>• Lesen Sie die Bedienungsanleitung bevor Sie dieses Fahrzeug fahren.</li><li>• Antes de conducir este vehículo, lea el Manual del Propietario.</li></ul>
	

5RU-21568-00

2

<b>TIRE INFORMATION</b>	
Cold tire normal pressure should be set as follows.	
● Up to 90 kg (198 lbs) load	
<b>FRONT</b>	: 175 kPa, {1.75 kgf/cm <sup>2</sup> }, 25psi
<b>REAR</b>	: 200 kPa, {2.00 kgf/cm <sup>2</sup> }, 29psi
● 90 kg (198 lbs) ~ maximum load	
<b>FRONT</b>	: 200 kPa, {2.00 kgf/cm <sup>2</sup> }, 29psi
<b>REAR</b>	: 225 kPa, {2.25 kgf/cm <sup>2</sup> }, 33psi

3CK-21668-A1

# DESCRIPTION

EAU10410

## Left view

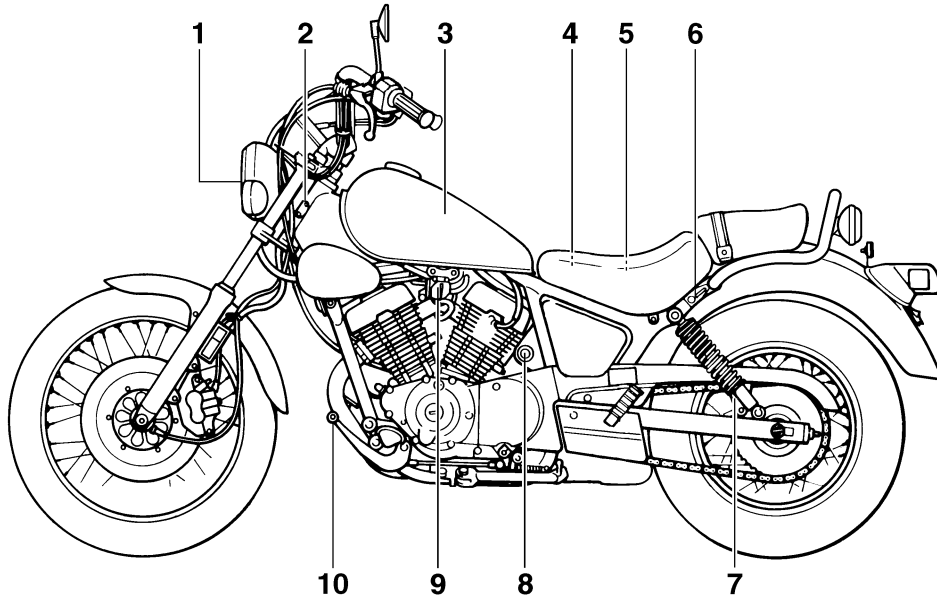

1. Headlight (page 6-28)

2. Steering lock (page 3-8)

3. Fuel tank (page 3-5)

4. Battery (page 6-26)

5. Fuses (page 6-28)

6. Helmet holder (page 3-9)

7. Shock absorber assembly spring preload adjusting ring (page 3-9)

8. Main switch (page 3-1)

9. Fuel cock (page 3-6)

10. Shift pedal (page 3-4)

## Right view

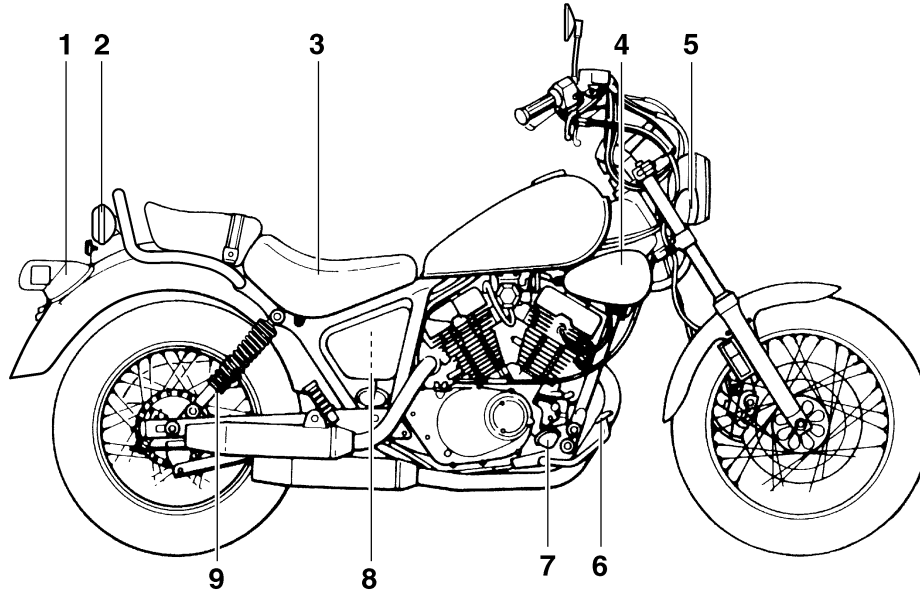

1. Tail/brake light (page 6-30)
2. Rear turn signal lights (page 6-30)
3. Rider seat (page 3-8)
4. Air filter element (page 6-9)
5. Front turn signal light (page 6-30)
6. Brake pedal (page 3-4)
7. Footrest
8. Owner's tool kit (page 6-1)

9. Shock absorber assembly spring preload adjusting ring (page 3-9)

# DESCRIPTION

EAU10430

## Controls and instruments

2

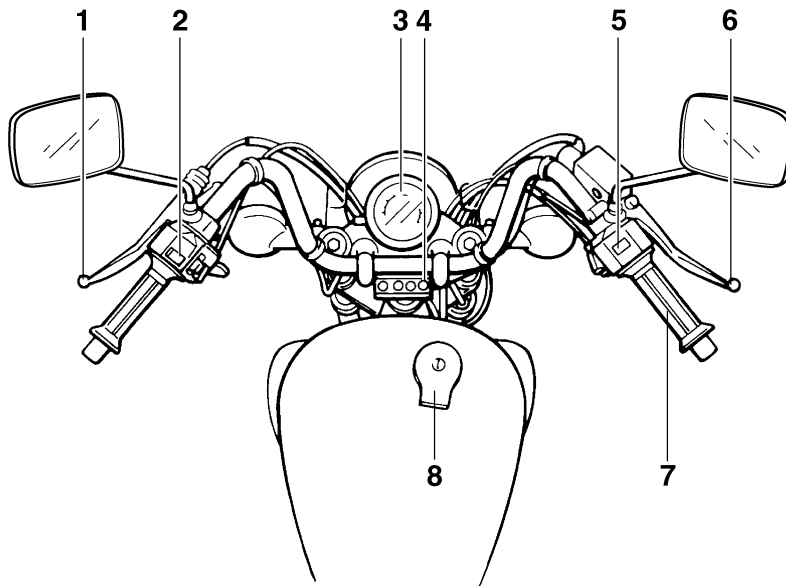

1. Clutch lever (page 3-3)
2. Left handlebar switches (page 3-2)
3. Speedometer unit (page 3-2)
4. Indicator lights (page 3-1)
5. Right handlebar switches (page 3-2)
6. Brake lever (page 3-4)
7. Throttle grip (page 6-12)
8. Fuel tank cap (page 3-5)



# INSTRUMENT AND CONTROL FUNCTIONS

## Main switch

EAU10450

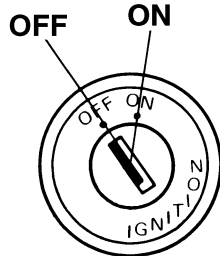

The main switch controls the ignition and lighting systems. The various main switch positions are described below.

### ON

EAU10480

All electrical systems are supplied with power, and the headlight, meter lighting and taillight come on, and the engine can be started. The key cannot be removed.

### OFF

EAU10660

All electrical systems are off. The key can be removed.

## Indicator lights

EAU10980

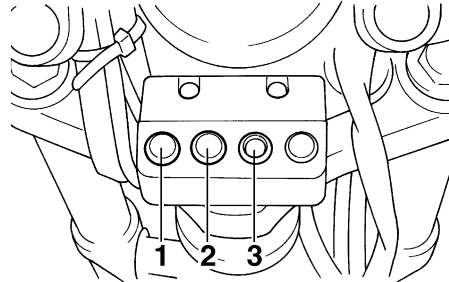

1. High beam indicator light "HIGH BEAM"
2. Neutral indicator light "NEUTRAL"
3. Turn signal indicator light "TURN"

### Turn signal indicator light "TURN"

EAU11040

This indicator light flashes when the turn signal switch is pushed to the left or right.

### Neutral indicator light "NEUTRAL"

EAU11070

This indicator light comes on when the transmission is in the neutral position.

### High beam indicator light "HIGH BEAM"

EAU11090

This indicator light comes on when the high beam of the headlight is switched on.

# INSTRUMENT AND CONTROL FUNCTIONS

## Speedometer unit

EAU11630

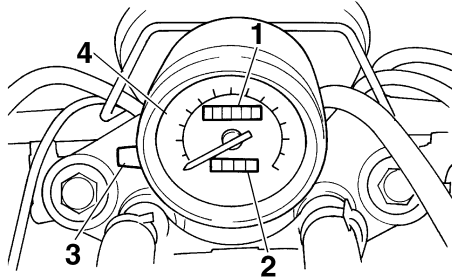

1. Odometer
2. Tripmeter
3. Tripmeter reset knob
4. Speedometer

The speedometer unit is equipped with a speedometer, an odometer and a tripmeter. The speedometer shows riding speed. The odometer shows the total distance traveled. The tripmeter shows the distance traveled since it was last set to zero with the reset knob. The tripmeter can be used to estimate the distance that can be traveled with a full tank of fuel. This information will enable you to plan future fuel stops.

## Handlebar switches

EAU12346

### Left

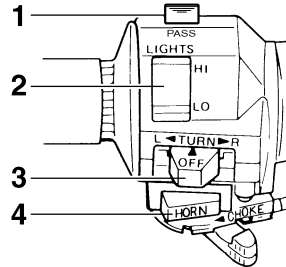

1. Pass switch "PASS"
2. Dimmer switch "LIGHTS"
3. Turn signal switch "TURN"
4. Horn switch "HORN"

### Right

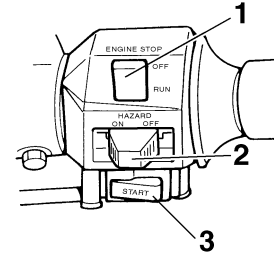

1. Engine stop switch "ENGINE STOP"
2. Hazard switch "HAZARD"
3. Start switch "START"

### Pass switch "PASS"

EAU12360

Press this switch to flash the headlight.

### Dimmer switch "LIGHTS"

EAU12410

Set the switch to "HI" for the high beam and to "LO" for the low beam.

### Turn signal switch "TURN"

EAU12440

To signal a right-hand turn, push this switch to the right. To signal a left-hand turn, push this switch to the left. When released, the switch returns to the cen-

ter position. To cancel the turn signal lights, push the switch in after it has returned to the center position.

## Horn switch “HORN”

EAU12510

Press this switch to sound the horn.

## Engine stop switch “ENGINE STOP”

EAU12650

Set this switch to “RUN” before starting the engine. Set this switch to “OFF” to stop the engine in case of an emergency, such as when the vehicle overturns or when the throttle cable is stuck.

## Start switch “START”

EAU12690

Push this switch to crank the engine with the starter.

ECA10050

### CAUTION:

**See page 5-1 for starting instructions prior to starting the engine.**

## Hazard switch “HAZARD”

EAU12752

With the key in the “ON” position, use this switch to turn on the hazard lights (simultaneous flashing of all turn signal lights).

The hazard lights are used in case of an emergency or to warn other drivers when your vehicle is stopped where it might be a traffic hazard.

### CAUTION:

**Do not use the hazard lights for an extended length of time with the engine not running, otherwise the battery may discharge.**

## Clutch lever

EAU12820

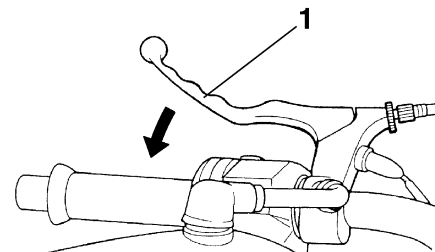

1. Clutch lever

The clutch lever is located at the left handlebar grip. To disengage the clutch, pull the lever toward the handlebar grip. To engage the clutch, release the lever. The lever should be pulled rapidly and released slowly for smooth clutch operation.

The clutch lever is equipped with a clutch switch, which is part of the ignition circuit cut-off system. (See page 3-11.)

# INSTRUMENT AND CONTROL FUNCTIONS

## Shift pedal

EAU12870

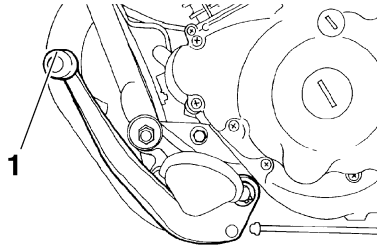

1. Shift pedal

The shift pedal is located on the left side of the engine and is used in combination with the clutch lever when shifting the gears of the 5-speed constant-mesh transmission equipped on this motorcycle.

## Brake lever

EAU12890

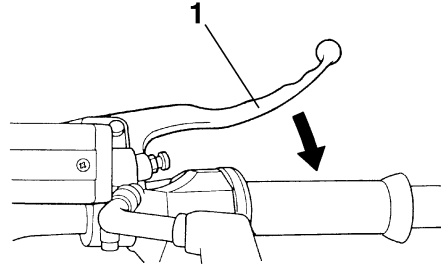

1. Brake lever

The brake lever is located at the right handlebar grip. To apply the front brake, pull the lever toward the handlebar grip.

## Brake pedal

EAU12941

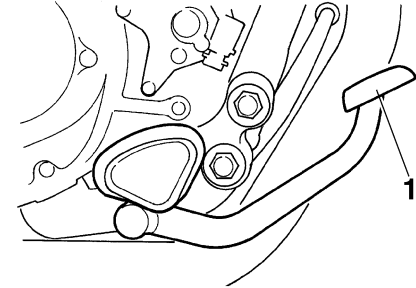

1. Brake pedal

The brake pedal is on the right side of the motorcycle. To apply the rear brake, press down on the brake pedal.

## Fuel tank cap

EAU13040

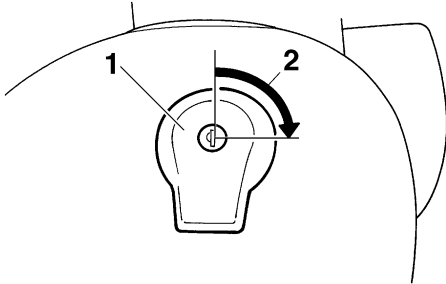

1. Fuel tank cap
2. Unlock.

### To open the fuel tank cap

Insert the key into the lock and turn it 1/4 turn clockwise. The lock will be released and the fuel tank cap can be opened.

### To close the fuel tank cap

1. Push the fuel tank cap into position with the key inserted in the lock.
2. Turn the key counterclockwise to the original position, and then remove it.

**NOTE:** \_\_\_\_\_  
The fuel tank cap cannot be closed unless the key is in the lock. In addition, the key cannot be removed if the cap is not properly closed and locked.

EWA11090

### **WARNING**

**Make sure that the fuel tank cap is properly closed before riding.**

## Fuel

EAU13211

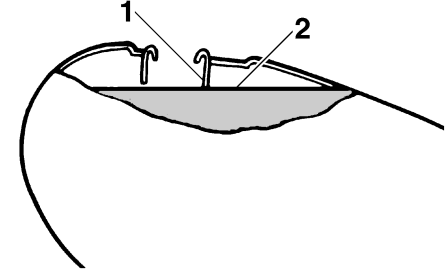

1. Fuel tank filler tube
2. Fuel level

Make sure that there is sufficient fuel in the tank. Fill the fuel tank to the bottom of the filler tube as shown.

EWA10880

### **WARNING**

- Do not overfill the fuel tank, otherwise it may overflow when the fuel warms up and expands.
- Avoid spilling fuel on the hot engine.

# INSTRUMENT AND CONTROL FUNCTIONS

ECA10070

## CAUTION:

Immediately wipe off spilled fuel with a clean, dry, soft cloth, since fuel may deteriorate painted surfaces or plastic parts.

EAU13330

### Recommended fuel:

UNLEADED GASOLINE ONLY

### Fuel tank capacity:

9.5 L (2.51 US gal) (2.09 Imp.gal)

### Fuel reserve amount:

2.6 L (0.69 US gal) (0.57 Imp.gal)

ECA11400

## CAUTION:

Use only unleaded gasoline. The use of leaded gasoline will cause severe damage to internal engine parts, such as the valves and piston rings, as well as to the exhaust system.

Your Yamaha engine has been designed to use regular unleaded gasoline with a research octane number of 91 or higher. If knocking (or pinging) occurs, use a gasoline of a different brand

or premium unleaded fuel. Use of unleaded fuel will extend spark plug life and reduce maintenance costs.

## Fuel cock

EAU13581

This model is equipped with a negative pressure fuel cock. The fuel cock supplies fuel from the tank to the carburetor while also filtering it.

The fuel cock lever positions are explained as follows and shown in the illustrations.

## ON

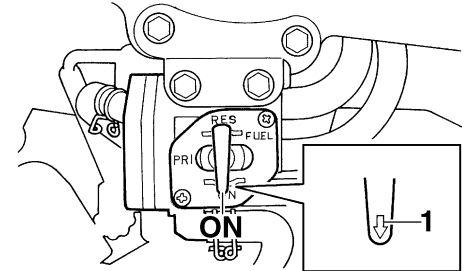

1. Arrow mark positioned over "ON"

With the fuel cock lever in this position, fuel flows to the carburetor when the engine is running. Turn the fuel cock lever to this position when starting the engine and riding.

# INSTRUMENT AND CONTROL FUNCTIONS

EAU13630

## RES

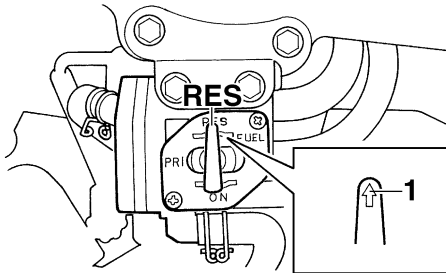

1. Arrow mark positioned over "RES"

This indicates reserve. With the fuel cock lever in this position, the fuel reserve is made available. Quickly turn the fuel cock lever to this position if you run out of fuel while riding, otherwise the engine may stall and will have to be primed (see "PRI"). After turning the fuel cock lever to "RES", refuel as soon as possible and be sure to turn the fuel cock lever back to "ON"!

## PRI

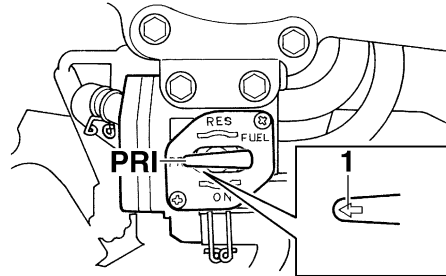

1. Arrow mark positioned over "PRI"

This indicates prime. With the fuel cock lever in this position, the engine can be "primed". Turn the fuel cock lever to this position when the engine has been allowed to run out of fuel. This sends fuel directly to the carburetor, which will make starting easier. After the engine has started, be sure to turn the lever to "ON" (or "RES" if you have not refueled yet).

## Starter (choke) lever

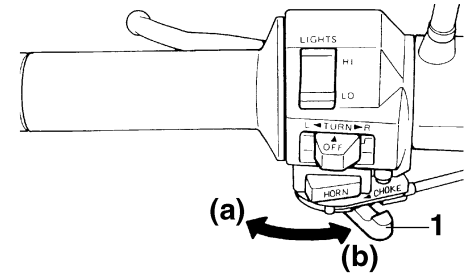

1. Starter (choke) lever

Starting a cold engine requires a richer air-fuel mixture, which is supplied by the starter (choke). Move the lever in direction (a) to turn on the starter (choke). Move the lever in direction (b) to turn off the starter (choke).

# INSTRUMENT AND CONTROL FUNCTIONS

## Steering lock

EAU13730

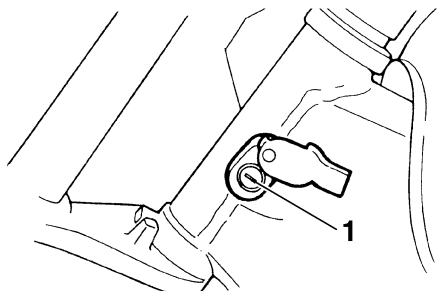

3

1. Steering lock

### To lock the steering

1. Turn the handlebar all the way to the right.
2. Open the steering lock cover, and then insert the key.
3. Turn the key 1/8 turn counterclockwise, push it in while turning the handlebar slightly to the left, and then turn the key 1/8 turn clockwise.
4. Check that the steering is locked, remove the key, and then close the lock cover.

### To unlock the steering

1. Open the steering lock cover, and then insert the key.
2. Push the key in, turn it 1/8 turn counterclockwise so that it moves out, and then release it.
3. Remove the key, and then close the lock cover.

## Rider seat

EAU14220

### To remove the rider seat

Remove the bolts, and then pull the rider seat off.

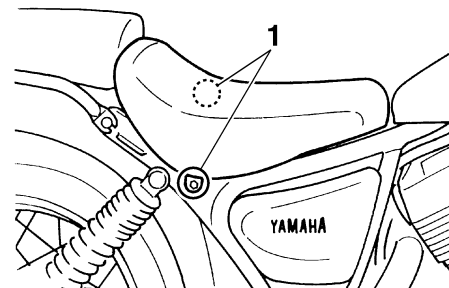

1. Bolt

### To install the rider seat

1. Insert the projection on the front of the rider seat into the seat holder as shown.



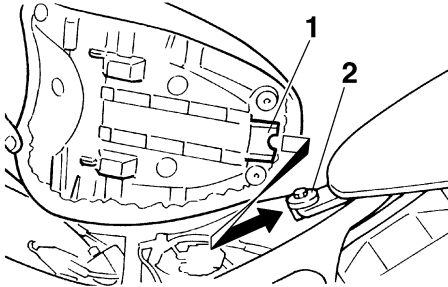

1. Projection
2. Seat holder

2. Place the rider seat in the original position, and then tighten the bolts.

**NOTE:** \_\_\_\_\_  
Make sure that the rider seat is properly secured before riding.  
\_\_\_\_\_

## Helmet holder

EAU14281

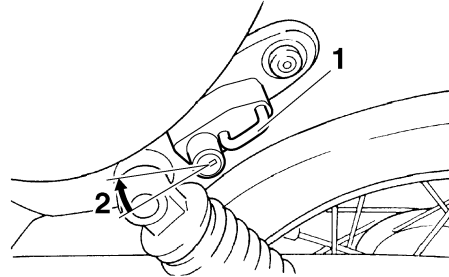

1. Helmet holder
2. Unlock.

To open the helmet holder, insert the key into the lock, and then turn the key as shown.

To lock the helmet holder, place it in the original position, and then remove the key.

## **! WARNING** \_\_\_\_\_

EWA10160

**Never ride with a helmet attached to the helmet holder, since the helmet may hit objects, causing loss of control and possibly an accident.**  
\_\_\_\_\_

## Adjusting the shock absorber assemblies

EAU14880

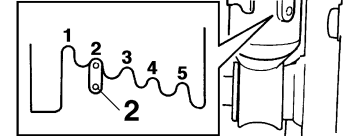
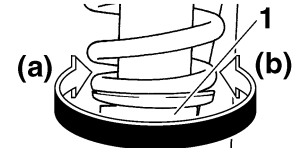

1. Spring preload adjusting ring
2. Position indicator

Each shock absorber assembly is equipped with a spring preload adjusting ring.

ECA10100

## **CAUTION:** \_\_\_\_\_

**Never attempt to turn an adjusting mechanism beyond the maximum or minimum settings.**  
\_\_\_\_\_

# INSTRUMENT AND CONTROL FUNCTIONS

EWA10210



## WARNING

**Always adjust both shock absorber assemblies equally, otherwise poor handling and loss of stability may result.**

Adjust the spring preload as follows.

To increase the spring preload and thereby harden the suspension, turn the adjusting ring on each shock absorber assembly in direction (a). To decrease the spring preload and thereby soften the suspension, turn the adjusting ring on each shock absorber assembly in direction (b).

### NOTE:

Align the appropriate notch in the adjusting ring with the position indicator on the shock absorber.

#### Spring preload setting:

Minimum (soft):

1

Standard:

2

Maximum (hard):

5

EAU15301

## Sidestand

The sidestand is located on the left side of the frame. Raise the sidestand or lower it with your foot while holding the vehicle upright.

### NOTE:

The built-in sidestand switch is part of the ignition circuit cut-off system, which cuts the ignition in certain situations. (See further down for an explanation of the ignition circuit cut-off system.)

EWA10240



## WARNING

**The vehicle must not be ridden with the sidestand down, or if the sidestand cannot be properly moved up (or does not stay up), otherwise the sidestand could contact the ground and distract the operator, resulting in a possible loss of control. Yamaha's ignition circuit cut-off system has been designed to assist the operator in fulfilling the responsibility of raising the sidestand before starting off. Therefore, check this system regularly as described**

**below and have a Yamaha dealer repair it if it does not function properly.**

EAU15311

## Ignition circuit cut-off system

The ignition circuit cut-off system (comprising the sidestand switch, clutch switch and neutral switch) has the following functions.

- It prevents starting when the transmission is in gear and the sidestand is up, but the clutch lever is not pulled.
- It prevents starting when the transmission is in gear and the clutch lever is pulled, but the sidestand is still down.
- It cuts the running engine when the transmission is in gear and the sidestand is moved down.

Periodically check the operation of the ignition circuit cut-off system according to the following procedure.

EWA10250



---

**If a malfunction is noted, have a Yamaha dealer check the system before riding.**

---

# INSTRUMENT AND CONTROL FUNCTIONS

3

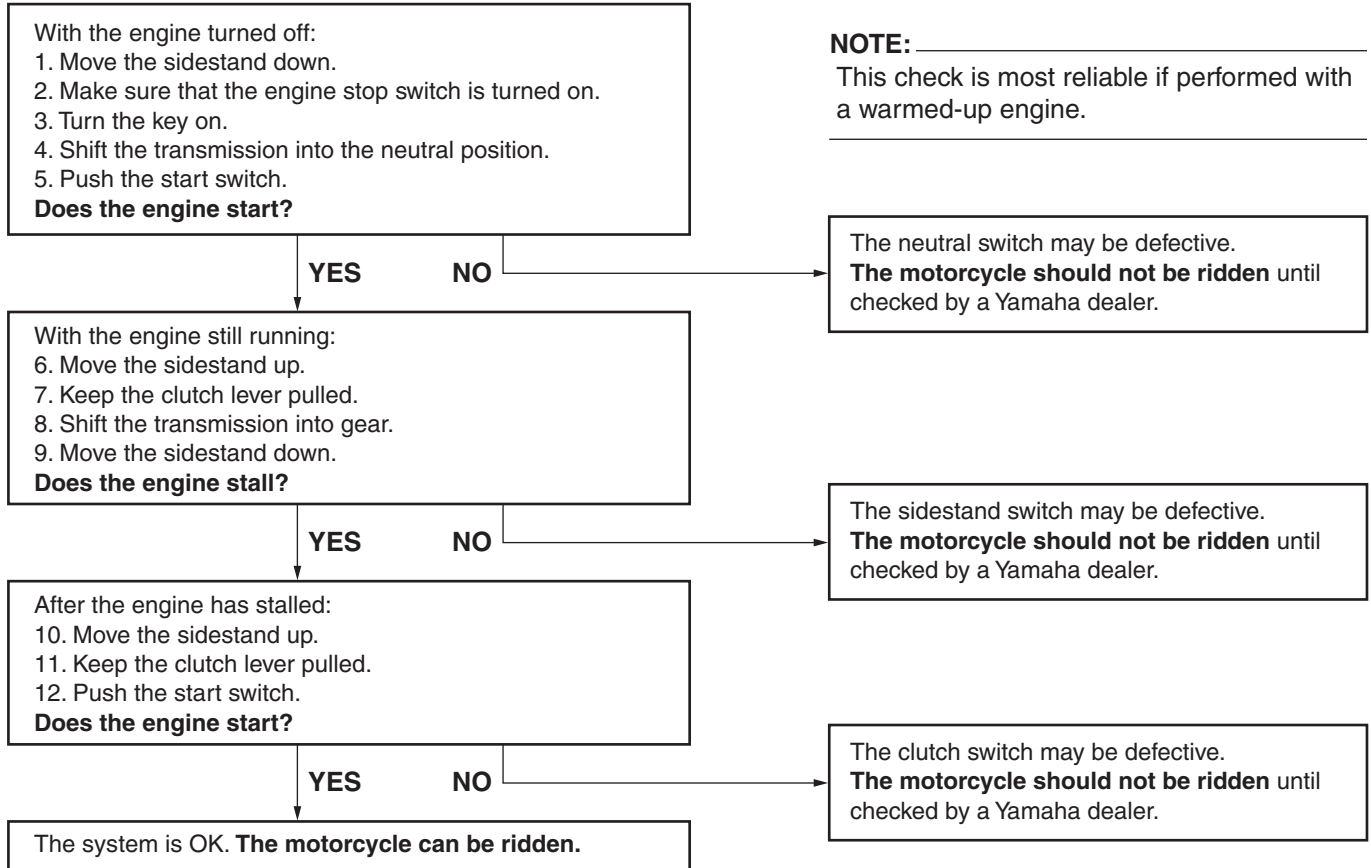

# PRE-OPERATION CHECKS

---

---

EAU15591

The condition of a vehicle is the owner's responsibility. Vital components can start to deteriorate quickly and unexpectedly, even if the vehicle remains unused (for example, as a result of exposure to the elements). Any damage, fluid leakage or loss of tire air pressure could have serious consequences. Therefore, it is very important, in addition to a thorough visual inspection, to check the following points before each ride.

**NOTE:** \_\_\_\_\_

Pre-operation checks should be made each time the vehicle is used. Such an inspection can be accomplished in a very short time; and the added safety it assures is more than worth the time involved.

---

EWA11150



**If any item in the Pre-operation check list is not working properly, have it inspected and repaired before operating the vehicle.**

---

# PRE-OPERATION CHECKS

EAU15605

## Pre-operation check list

ITEM	CHECKS	PAGE
Fuel	<ul style="list-style-type: none"><li>• Check fuel level in fuel tank.</li><li>• Refuel if necessary.</li><li>• Check fuel line for leakage.</li></ul>	3-5
Engine oil	<ul style="list-style-type: none"><li>• Check oil level in engine.</li><li>• If necessary, add recommended oil to specified level.</li><li>• Check vehicle for oil leakage.</li></ul>	6-7
Front brake	<ul style="list-style-type: none"><li>• Check operation.</li><li>• If soft or spongy, have Yamaha dealer bleed hydraulic system.</li><li>• Check lever free play.</li><li>• Adjust if necessary.</li><li>• Check brake pads for wear.</li><li>• Replace if necessary.</li><li>• Check fluid level in reservoir.</li><li>• If necessary, add recommended brake fluid to specified level.</li><li>• Check hydraulic system for leakage.</li></ul>	6-15, 6-18, 6-18
Rear brake	<ul style="list-style-type: none"><li>• Check operation.</li><li>• Lubricate cable if necessary.</li><li>• Check pedal free play.</li><li>• Adjust if necessary.</li></ul>	6-16, 6-18
Clutch	<ul style="list-style-type: none"><li>• Check operation.</li><li>• Lubricate cable if necessary.</li><li>• Check lever free play.</li><li>• Adjust if necessary.</li></ul>	6-14
Throttle grip	<ul style="list-style-type: none"><li>• Make sure that operation is smooth.</li><li>• Check cable free play.</li><li>• If necessary, have Yamaha dealer adjust cable free play and lubricate cable and grip housing.</li></ul>	6-12, 6-23
Control cables	<ul style="list-style-type: none"><li>• Make sure that operation is smooth.</li><li>• Lubricate if necessary.</li></ul>	6-22

4

# PRE-OPERATION CHECKS

ITEM	CHECKS	PAGE
<b>Drive chain</b>	<ul style="list-style-type: none"> <li>• Check chain slack.</li> <li>• Adjust if necessary.</li> <li>• Check chain condition.</li> <li>• Lubricate if necessary.</li> </ul>	6-20, 6-22
<b>Wheels and tires</b>	<ul style="list-style-type: none"> <li>• Check for damage.</li> <li>• Check tire condition and tread depth.</li> <li>• Check air pressure.</li> <li>• Correct if necessary.</li> </ul>	6-12, 6-14
<b>Brake and shift pedals</b>	<ul style="list-style-type: none"> <li>• Make sure that operation is smooth.</li> <li>• Lubricate pedal pivoting points if necessary.</li> </ul>	6-23
<b>Brake and clutch levers</b>	<ul style="list-style-type: none"> <li>• Make sure that operation is smooth.</li> <li>• Lubricate lever pivoting points if necessary.</li> </ul>	6-23
<b>Sidestand</b>	<ul style="list-style-type: none"> <li>• Make sure that operation is smooth.</li> <li>• Lubricate pivot if necessary.</li> </ul>	6-24
<b>Chassis fasteners</b>	<ul style="list-style-type: none"> <li>• Make sure that all nuts, bolts and screws are properly tightened.</li> <li>• Tighten if necessary.</li> </ul>	—
<b>Instruments, lights, signals and switches</b>	<ul style="list-style-type: none"> <li>• Check operation.</li> <li>• Correct if necessary.</li> </ul>	—
<b>Sidestand switch</b>	<ul style="list-style-type: none"> <li>• Check operation of ignition circuit cut-off system.</li> <li>• If system is defective, have Yamaha dealer check vehicle.</li> </ul>	3-10
<b>Battery</b>	<ul style="list-style-type: none"> <li>• Check fluid level.</li> <li>• Fill with distilled water if necessary.</li> </ul>	6-26

# OPERATION AND IMPORTANT RIDING POINTS

---

EAU15950

EAU32630

EWA10270

## **WARNING**

- **Become thoroughly familiar with all operating controls and their functions before riding. Consult a Yamaha dealer regarding any control or function that you do not thoroughly understand.**
- **Never start the engine or operate it in a closed area for any length of time. Exhaust fumes are poisonous, and inhaling them can cause loss of consciousness and death within a short time. Always make sure that there is adequate ventilation.**
- **Before starting out, make sure that the sidestand is up. If the sidestand is not raised completely, it could contact the ground and distract the operator, resulting in a possible loss of control.**

## **Starting and warming up a cold engine**

In order for the ignition circuit cut-off system to enable starting, one of the following conditions must be met:

- The transmission is in the neutral position.
- The transmission is in gear with the clutch lever pulled and the sidestand up.

EWA10290

## **WARNING**

- **Before starting the engine, check the function of the ignition circuit cut-off system according to the procedure described on page 3-11.**
- **Never ride with the sidestand down.**

1. Turn the fuel cock lever to “ON”.
2. Turn the key to “ON” and make sure that the engine stop switch is set to “RUN”.
3. Shift the transmission into the neutral position.

## **NOTE:** \_\_\_\_\_

When the transmission is in the neutral position, the neutral indicator light should be on, otherwise have a Yamaha dealer check the electrical circuit.

4. Turn the starter (choke) on and completely close the throttle. (See page 3-7.)
5. Start the engine by pushing the start switch.

## **NOTE:** \_\_\_\_\_

If the engine fails to start, release the start switch, wait a few seconds, and then try again. Each starting attempt should be as short as possible to preserve the battery. Do not crank the engine more than 10 seconds on any one attempt.

6. After starting the engine, move the starter (choke) back halfway.



# OPERATION AND IMPORTANT RIDING POINTS

ECA11130

## CAUTION:

**For maximum engine life, always warm the engine up before starting off. Never accelerate hard when the engine is cold!**

7. When the engine is warm, turn the starter (choke) off.

## NOTE:

The engine is warm when it responds normally to the throttle with the starter (choke) turned off.

EAU16640

## Starting a warm engine

Follow the same procedure as for starting a cold engine with the exception that the starter (choke) is not required when the engine is warm.

EAU16671

## Shifting

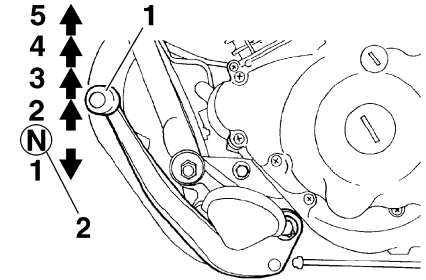

1. Shift pedal
2. Neutral position

Shifting gears lets you control the amount of engine power available for starting off, accelerating, climbing hills, etc.

The gear positions are shown in the illustration.

## NOTE:

To shift the transmission into the neutral position, press the shift pedal down repeatedly until it reaches the end of its travel, and then slightly raise it.

# OPERATION AND IMPORTANT RIDING POINTS

---

ECA10260

## CAUTION:

- Even with the transmission in the neutral position, do not coast for long periods of time with the engine off, and do not tow the motorcycle for long distances. The transmission is properly lubricated only when the engine is running. Inadequate lubrication may damage the transmission.
  - Always use the clutch while changing gears to avoid damaging the engine, transmission, and drive train, which are not designed to withstand the shock of forced shifting.
- 

EAU16800

## Tips for reducing fuel consumption

Fuel consumption depends largely on your riding style. Consider the following tips to reduce fuel consumption:

- Turn the starter (choke) off as soon as possible.
- Shift up swiftly, and avoid high engine speeds during acceleration.
- Do not rev the engine while shifting down, and avoid high engine speeds with no load on the engine.
- Turn the engine off instead of letting it idle for an extended length of time (e.g., in traffic jams, at traffic lights or at railroad crossings).

EAU16841

## Engine break-in

There is never a more important period in the life of your engine than the period between 0 and 1600 km (1000 mi). For this reason, you should read the following material carefully.

Since the engine is brand new, do not put an excessive load on it for the first 1600 km (1000 mi). The various parts in the engine wear and polish themselves to the correct operating clearances. During this period, prolonged full-throttle operation or any condition that might result in engine overheating must be avoided.

EAU17021

### 0–1000 km (0–600 mi)

Avoid prolonged operation above 1/3 throttle.

### 1000–1600 km (600–1000 mi)

Avoid prolonged operation above 1/2 throttle.

# OPERATION AND IMPORTANT RIDING POINTS

ECA11281

## CAUTION:

**After 1000 km (600 mi) of operation, the engine oil must be changed, and the oil filter cartridge or element replaced.**

## 1600 km (1000 mi) and beyond

The vehicle can now be operated normally.

ECA10270

## CAUTION:

**If any engine trouble should occur during the engine break-in period, immediately have a Yamaha dealer check the vehicle.**

EAU17200

## Parking

When parking, stop the engine, and then remove the key from the main switch.

EWA10310

## WARNING

- **Since the engine and exhaust system can become very hot, park in a place where pedestrians or children are not likely to touch them.**
- **Do not park on a slope or on soft ground, otherwise the vehicle may overturn.**

# PERIODIC MAINTENANCE AND MINOR REPAIR

EAU17240

EAU17340

EWA10350

Safety is an obligation of the owner. Periodic inspection, adjustment and lubrication will keep your vehicle in the safest and most efficient condition possible. The most important points of inspection, adjustment, and lubrication are explained on the following pages. The intervals given in the periodic maintenance and lubrication chart should be simply considered as a general guide under normal riding conditions. However, **DEPENDING ON THE WEATHER, TERRAIN, GEOGRAPHICAL LOCATION, AND INDIVIDUAL USE, THE MAINTENANCE INTERVALS MAY NEED TO BE SHORTENED.**

6

## **! WARNING**

**If you are not familiar with maintenance work, have a Yamaha dealer do it for you.**

EWA10320

## Owner's tool kit

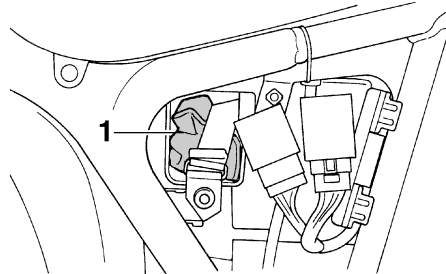

1. Owner's tool kit

The owner's tool kit is located behind panel A. (See page 6-5.)

The service information included in this manual and the tools provided in the owner's tool kit are intended to assist you in the performance of preventive maintenance and minor repairs. However, additional tools such as a torque wrench may be necessary to perform certain maintenance work correctly.

## **NOTE:**

If you do not have the tools or experience required for a particular job, have a Yamaha dealer perform it for you.

## **! WARNING**

**Modifications not approved by Yamaha may cause loss of performance and render the vehicle unsafe for use. Consult a Yamaha dealer before attempting any changes.**

# PERIODIC MAINTENANCE AND MINOR REPAIR

EAU17705

## Periodic maintenance and lubrication chart

### NOTE:

- The annual checks must be performed every year, except if a kilometer-based maintenance is performed instead.
- From 50000 km, repeat the maintenance intervals starting from 10000 km.
- Items marked with an asterisk should be performed by a Yamaha dealer as they require special tools, data and technical skills.

NO.	ITEM	CHECK OR MAINTENANCE JOB	ODOMETER READING (× 1000 km)					ANNUAL CHECK
			1	10	20	30	40	
1	* Fuel line	• Check fuel and vacuum hoses for cracks or damage.		√	√	√	√	√
2	Spark plugs	• Check condition. • Clean and regap.		√		√		
		• Replace.			√		√	
3	* Valves	• Check valve clearance. • Adjust.		√	√	√	√	
4	Air filter element	• Clean.		√		√		
		• Replace.			√		√	
5	* Battery	• Check electrolyte level and specific gravity. • Make sure that the breather hose is properly routed.		√	√	√	√	√
6	Clutch	• Check operation. • Adjust.	√	√	√	√	√	
7	* Front brake	• Check operation, fluid level and vehicle for fluid leakage.	√	√	√	√	√	√
		• Replace brake pads.	Whenever worn to the limit					
8	* Rear brake	• Check operation and adjust brake pedal free play.	√	√	√	√	√	√
		• Replace brake shoes.	Whenever worn to the limit					

# PERIODIC MAINTENANCE AND MINOR REPAIR

NO.	ITEM	CHECK OR MAINTENANCE JOB	ODOMETER READING (× 1000 km)					ANNUAL CHECK
			1	10	20	30	40	
9	*	<b>Brake hose</b> • Check for cracks or damage. • Replace.		√	√	√	√	√
			Every 4 years					
10	*	<b>Wheels</b> • Check runout, spoke tightness and for damage. • Tighten spokes if necessary.		√	√	√	√	
11	*	<b>Tires</b> • Check tread depth and for damage. • Replace if necessary. • Check air pressure. • Correct if necessary.		√	√	√	√	√
12	*	<b>Wheel bearings</b> • Check bearing for looseness or damage.		√	√	√	√	
13	*	<b>Swingarm pivot bushes</b> • Check bush assemblies for looseness. • Lubricate with lithium-soap-based grease.		√	√	√	√	
			Every 50000 km					
14		<b>Drive chain</b> • Check chain slack, alignment and condition. • Adjust and lubricate chain with a special O-ring chain lubricant thoroughly.	Every 1000 km and after washing the motorcycle or riding in the rain					
15	*	<b>Steering bearings</b> • Check bearing play and steering for roughness. • Lubricate with lithium-soap-based grease.	√	√	√	√	√	
			Every 20000 km					
16	*	<b>Chassis fasteners</b> • Make sure that all nuts, bolts and screws are properly tightened.		√	√	√	√	√
17		<b>Sidestand</b> • Check operation. • Lubricate.		√	√	√	√	√
18	*	<b>Sidestand switch</b> • Check operation.	√	√	√	√	√	√
19	*	<b>Front fork</b> • Check operation and for oil leakage.		√	√	√	√	
20	*	<b>Shock absorber assemblies</b> • Check operation and shock absorbers for oil leakage.		√	√	√	√	
21	*	<b>Carburetor</b> • Check starter (choke) operation. • Adjust engine idling speed.	√	√	√	√	√	√

# PERIODIC MAINTENANCE AND MINOR REPAIR

NO.	ITEM	CHECK OR MAINTENANCE JOB	ODOMETER READING (× 1000 km)					ANNUAL CHECK
			1	10	20	30	40	
22	Engine oil	<ul style="list-style-type: none"> <li>• Change.</li> <li>• Check oil level and vehicle for oil leakage.</li> </ul>	√	√	√	√	√	√
23	Engine oil filter element	<ul style="list-style-type: none"> <li>• Replace.</li> </ul>	√		√		√	
24	* Front and rear brake switches	<ul style="list-style-type: none"> <li>• Check operation.</li> </ul>	√	√	√	√	√	√
25	Moving parts and cables	<ul style="list-style-type: none"> <li>• Lubricate.</li> </ul>		√	√	√	√	√
26	* Throttle grip housing and cable	<ul style="list-style-type: none"> <li>• Check operation and free play.</li> <li>• Adjust the throttle cable free play if necessary.</li> <li>• Lubricate the throttle grip housing and cable.</li> </ul>		√	√	√	√	√
27	* Lights, signals and switches	<ul style="list-style-type: none"> <li>• Check operation.</li> <li>• Adjust headlight beam.</li> </ul>	√	√	√	√	√	√

EAU18660

6

**NOTE:** \_\_\_\_\_

- The air filter needs more frequent service if you are riding in unusually wet or dusty areas.
- Hydraulic brake service
  - Regularly check and, if necessary, correct the brake fluid level.
  - Every two years replace the internal components of the brake master cylinder and caliper, and change the brake fluid.
  - Replace the brake hoses every four years and if cracked or damaged.

# PERIODIC MAINTENANCE AND MINOR REPAIR

## Removing and installing the panel

EAU18751

The panel shown needs to be removed to perform some of the maintenance jobs described in this chapter. Refer to this section each time the panel needs to be removed and installed.

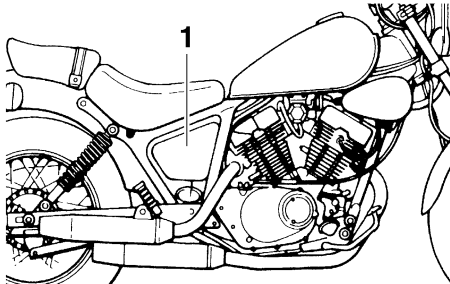

1. Panel A

## Panel A

EAU19510

### To remove the panel

Pull the rear of the panel out, and then slide the panel forward to release it in the front.

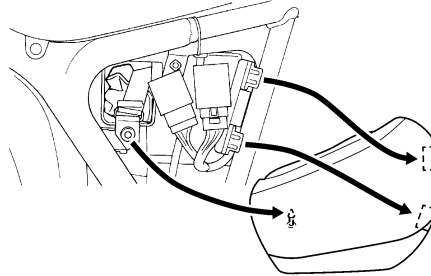

### To install the panel

Secure the front of the panel, and then push the rear of the panel in.

## Checking the spark plugs

EAU19544

The spark plugs are important engine components, which are easy to check. Since heat and deposits will cause any spark plug to slowly erode, the spark plugs should be removed and checked in accordance with the periodic maintenance and lubrication chart. In addition, the condition of the spark plugs can reveal the condition of the engine.

### To remove a spark plug

1. Remove the spark plug cap.

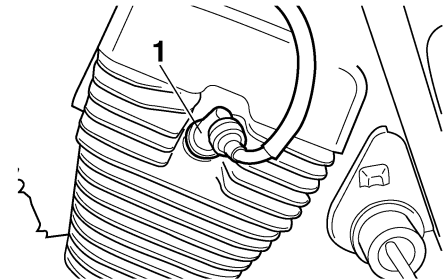

1. Spark plug cap

2. Remove the spark plug as shown, with the spark plug wrench included in the owner's tool kit.



# PERIODIC MAINTENANCE AND MINOR REPAIR

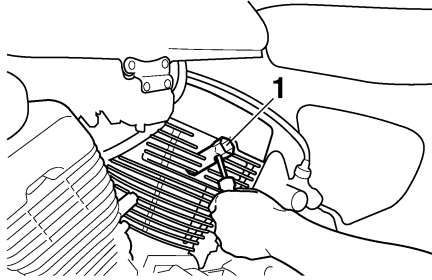

1. Spark plug wrench

## To check the spark plugs

1. Check that the porcelain insulator around the center electrode on each spark plug is a medium-to-light tan (the ideal color when the vehicle is ridden normally).
2. Check that all spark plugs installed in the engine have the same color.

## NOTE:

If any spark plug shows a distinctly different color, the engine could be operating improperly. Do not attempt to diagnose such problems yourself. Instead, have a Yamaha dealer check the vehicle.

3. Check each spark plug for electrode erosion and excessive carbon or other deposits, and replace it if necessary.

## Specified spark plug:

NGK/C6HSA  
DENSO/U20FS-U

## To install a spark plug

1. Measure the spark plug gap with a wire thickness gauge and, if necessary, adjust the gap to specification.

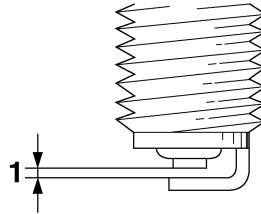

1. Spark plug gap

## Spark plug gap:

0.6–0.7 mm (0.024–0.028 in)

2. Clean the surface of the spark plug gasket and its mating surface, and then wipe off any grime from the spark plug threads.
3. Install the spark plug with the spark plug wrench, and then tighten it to the specified torque.

## Tightening torque:

Spark plug:  
12.5 Nm (1.25 m·kgf, 9.0 ft·lbf)

## NOTE:

If a torque wrench is not available when installing a spark plug, a good estimate of the correct torque is 1/4–1/2 turn past finger tight. However, the spark plug should be tightened to the specified torque as soon as possible.

4. Install the spark plug cap.

# PERIODIC MAINTENANCE AND MINOR REPAIR

EAU19751

## Engine oil and oil filter element

The engine oil level should be checked before each ride. In addition, the oil must be changed and the oil filter element replaced at the intervals specified in the periodic maintenance and lubrication chart.

### To check the engine oil level

1. Place the vehicle on a level surface and hold it in an upright position.

### NOTE:

Make sure that the vehicle is positioned straight up when checking the oil level. A slight tilt to the side can result in a false reading.

2. Start the engine, warm it up for several minutes, and then turn it off.
3. Wait a few minutes until the oil settles, and then check the oil level through the check window located at the bottom-right side of the crankcase.

### NOTE:

The engine oil should be between the minimum and maximum level marks.

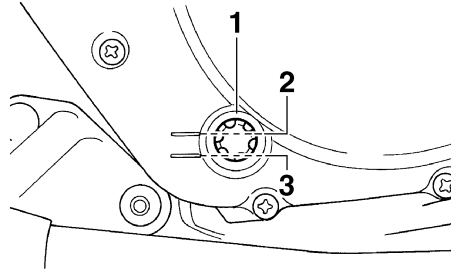

1. Engine oil level check window
2. Maximum level mark
3. Minimum level mark

4. If the engine oil is below the minimum level mark, add sufficient oil of the recommended type to raise it to the correct level.

### To change the engine oil (with or without oil filter element replacement)

1. Start the engine, warm it up for several minutes, and then turn it off.

2. Place an oil pan under the engine to collect the used oil.
3. Remove the engine oil filler cap and drain bolt to drain the oil from the crankcase.

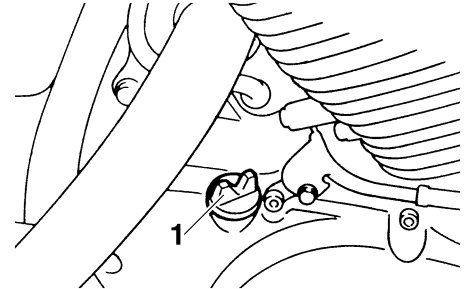

1. Engine oil filler cap

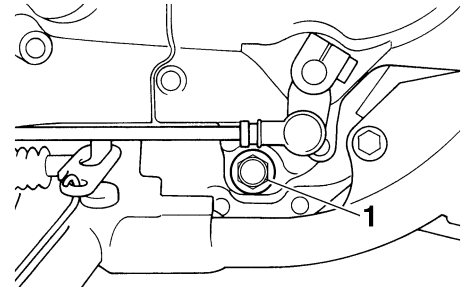

1. Engine oil drain bolt

# PERIODIC MAINTENANCE AND MINOR REPAIR

**NOTE:** \_\_\_\_\_

Skip steps 4–6 if the oil filter element is not being replaced.

4. Remove the oil filter element cover by removing the bolts.

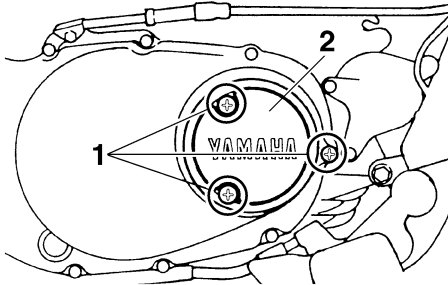

1. Bolt
2. Oil filter element cover

5. Remove and replace the oil filter element and O-ring.

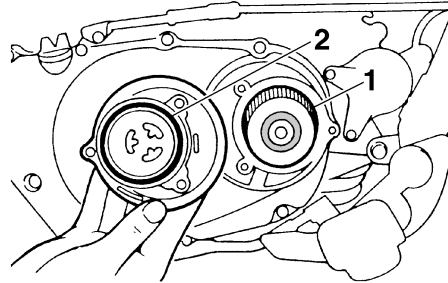

1. Oil filter element
2. O-ring

6. Install the oil filter element cover by installing the bolts, then tightening them to the specified torque.

**Tightening torque:**

Oil filter element cover bolt:  
7.0 Nm (0.7 m·kgf, 5.1 ft·lbf)

**NOTE:** \_\_\_\_\_

Make sure that the O-ring is properly seated.

7. Install the engine oil drain bolt, and then tighten it to the specified torque.

**Tightening torque:**

Engine oil drain bolt:  
34 Nm (3.4 m·kgf, 24 ft·lbf)

8. Add the specified amount of the recommended engine oil, and then install and tighten the oil filler cap.

**Recommended engine oil:**

See page 8-1.

**Oil quantity:**

With oil filter element replacement:  
1.60 L (1.69 US qt) (1.41 Imp.qt)  
Without oil filter element replacement:  
1.40 L (1.48 US qt) (1.23 Imp.qt)

ECA11620

**CAUTION:** \_\_\_\_\_

- In order to prevent clutch slippage (since the engine oil also lubricates the clutch), do not mix any chemical additives. Do not use oils with a diesel specification of “CD” or oils of a higher quality than specified. In addition, do not use oils labeled “ENERGY CONSERVING II” or higher.

# PERIODIC MAINTENANCE AND MINOR REPAIR

- **Make sure that no foreign material enters the crankcase.**

9. Start the engine, and then let it idle for several minutes while checking it for oil leakage. If oil is leaking, immediately turn the engine off and check for the cause.
10. Turn the engine off, and then check the oil level and correct it if necessary.

## Cleaning the air filter element

EAU32733

The air filter element should be cleaned at the intervals specified in the periodic maintenance and lubrication chart. Clean the air filter element more frequently if you are riding in unusually wet or dusty areas.

1. Remove the bolts and loosen the air filter case joint clamp screw.

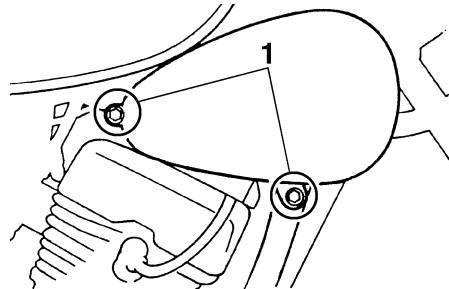

1. Bolt

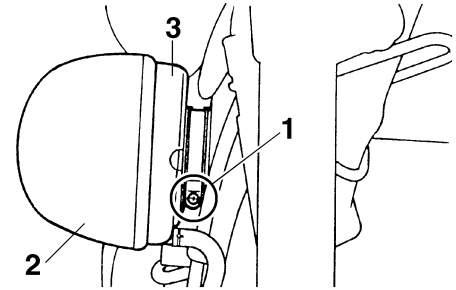

1. Air filter case joint clamp screw
2. Air filter case cover
3. Air filter case

2. Disconnect the hoses from the air filter case, and then remove the air filter case.

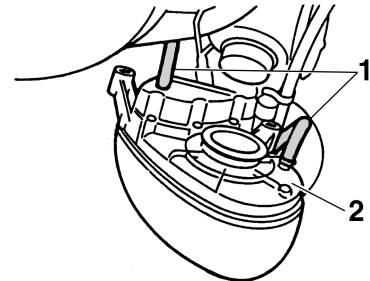

1. Hose
2. Air filter case

# PERIODIC MAINTENANCE AND MINOR REPAIR

3. Remove the air filter case cover by removing the screws.

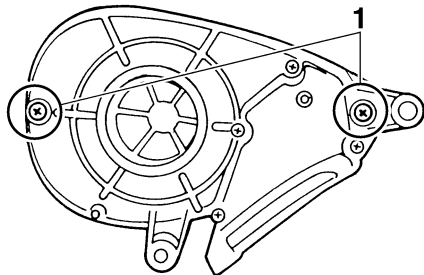

1. Screw

4. Remove the air filter element by removing the wing nut.

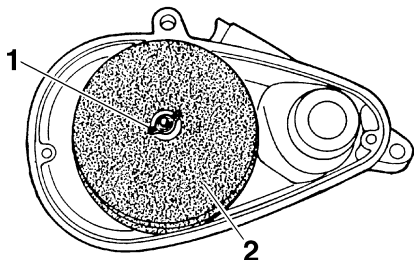

1. Wing nut  
2. Air filter element

5. Remove the sponge material from the air filter element frame, clean it with solvent, and then squeeze the remaining solvent out.

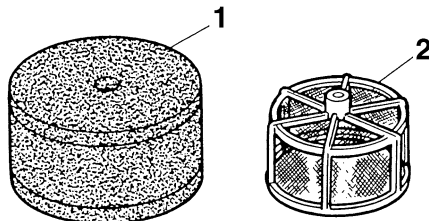

1. Sponge material  
2. Air filter element frame

6. Apply oil of the recommended type to the entire surface of the sponge material, and then squeeze the excess oil out.

**NOTE:** \_\_\_\_\_  
The air filter element should be wet but not dripping.

## Recommended oil:

Yamaha foam air filter oil or other quality foam air filter oil

7. Pull the sponge material over the air filter element frame.
8. Insert the element into the air filter case, and then tighten the wing nut.

ECA10480

## CAUTION:

- Make sure that the air filter element is properly seated in the air filter case.
- The engine should never be operated without the air filter element installed, otherwise the piston(s) and/or cylinder(s) may become excessively worn.

9. Install the air filter case cover by installing the screws.
10. Connect the hoses to the air filter case.
11. Push the air filter case onto the air filter case joint, and then tighten the clamp screw.
12. Install the air filter case bolts.

# PERIODIC MAINTENANCE AND MINOR REPAIR

## Adjusting the carburetor

EAU21280

The carburetor is an important part of the engine and requires very sophisticated adjustment. Therefore, most carburetor adjustments should be left to a Yamaha dealer, who has the necessary professional knowledge and experience. The adjustment described in the following section, however, may be serviced by the owner as part of routine maintenance.

ECA10550

### CAUTION:

**The carburetor has been set and extensively tested at the Yamaha factory. Changing these settings without sufficient technical knowledge may result in poor performance of or damage to the engine.**

6

## Adjusting the engine idling speed

EAU21340

The engine idling speed must be checked and, if necessary, adjusted as follows at the intervals specified in the periodic maintenance and lubrication chart.

The engine should be warm before making this adjustment.

### NOTE:

- The engine is warm when it quickly responds to the throttle.
- A diagnostic tachometer is needed to make this adjustment.

1. Attach the tachometer to the spark plug lead.
2. Check the engine idling speed and, if necessary, adjust it to specification by turning the throttle stop screw. To increase the engine idling speed, turn the screw in direction (a). To decrease the engine idling speed, turn the screw in direction (b).

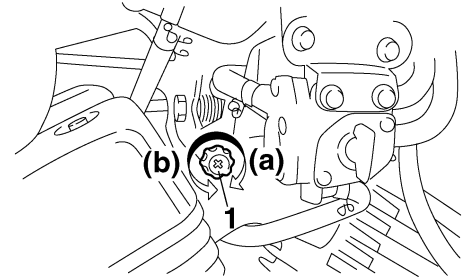

1. Throttle stop screw

**Engine idling speed:**  
1250–1350 r/min

### NOTE:

If the specified idling speed cannot be obtained as described above, have a Yamaha dealer make the adjustment.

## Checking the throttle cable free play

EAU21381

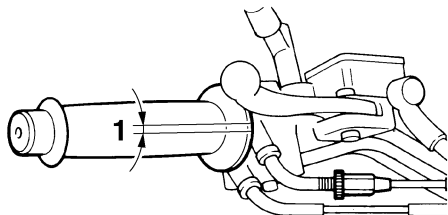

### 1. Throttle cable free play

The throttle cable free play should measure 3.0–5.0 mm (0.12–0.20 in) at the throttle grip. Periodically check the throttle cable free play and, if necessary, have a Yamaha dealer adjust it.

## Valve clearance

EAU21401

The valve clearance changes with use, resulting in improper air-fuel mixture and/or engine noise. To prevent this from occurring, the valve clearance must be adjusted by a Yamaha dealer at the intervals specified in the periodic maintenance and lubrication chart.

## Tires

EAU32771

To maximize the performance, durability, and safe operation of your motorcycle, note the following points regarding the specified tires.

### Tire air pressure

The tire air pressure should be checked and, if necessary, adjusted before each ride.

EWA10500

### **⚠ WARNING**

- The tire air pressure must be checked and adjusted on cold tires (i.e., when the temperature of the tires equals the ambient temperature).
- The tire air pressure must be adjusted in accordance with the riding speed and with the total weight of rider, passenger, cargo, and accessories approved for this model.

# PERIODIC MAINTENANCE AND MINOR REPAIR

**Tire air pressure (measured on cold tires):**

**0–90 kg (0–198 lb):**

Front:

175 kPa (25 psi) (1.75 kgf/cm<sup>2</sup>)

Rear:

200 kPa (29 psi) (2.00 kgf/cm<sup>2</sup>)

**90–196 kg (198–432 lb):**

Front:

200 kPa (29 psi) (2.00 kgf/cm<sup>2</sup>)

Rear:

225 kPa (33 psi) (2.25 kgf/cm<sup>2</sup>)

**Maximum load\*:**

196 kg (432 lb)

\* Total weight of rider, passenger, cargo and accessories

EWA10510

## **WARNING**

Proper loading of your vehicle is important for several characteristics of your vehicle, such as handling, braking, performance and safety. Do not carry loosely packed items that can shift. Securely pack your heaviest items close to the center of the vehicle, and distribute the weight evenly from side to side. Properly adjust the suspension for your load, and check the condition and pressure of your tires. **NEVER OVER-**

**LOAD YOUR VEHICLE.** Make sure that the total weight of the cargo, rider, passenger, and accessories (cowling, saddlebags, etc. if approved for this model) does not exceed the maximum load of the vehicle. Operation of an overloaded vehicle could cause tire damage, an accident, or even injury.

## Tire inspection

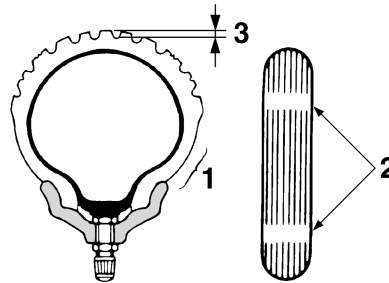

1. Tire sidewall
2. Tire wear indicator
3. Tire tread depth

Always check the tires before operating the motorcycle. If a tire tread shows crosswise lines (minimum tread depth), if the tire has a nail or glass fragments

in it, or if the sidewall is cracked, contact a Yamaha dealer immediately and have the tire replaced.

**Minimum tire tread depth (front and rear):**  
1.0 mm (0.04 in)

## NOTE:

The tire tread depth limits may differ from country to country. Always comply with the local regulations.

EWA10560

## **WARNING**

- It is dangerous to ride with a worn-out tire. When a tire tread begins to show crosswise lines, have a Yamaha dealer replace the tire immediately.
- The replacement of all wheel- and brake-related parts, including the tires, should be left to a Yamaha dealer, who has the necessary professional knowledge and experience.
- It is not recommended to patch a punctured tube. If unavoidable, however, patch the tube



# PERIODIC MAINTENANCE AND MINOR REPAIR

very carefully and replace it as soon as possible with a high-quality product.

## Tire information

This motorcycle is equipped with spoke wheels and tube tires.

EWA10460

### **WARNING**

- The front and rear tires should be of the same make and design, otherwise the handling characteristics of the vehicle cannot be guaranteed.
- After extensive tests, only the tires listed below have been approved for this model by Yamaha Motor Co., Ltd.

#### Front tire:

Size:

3.00-18 47P

Manufacturer/model:

CHENG SHIN/C-916

#### Rear tire:

Size:

130/90-15M/C 66P

Manufacturer/model:

CHENG SHIN/C-915

## Spoke wheels

EAU21940

To maximize the performance, durability, and safe operation of your motorcycle, note the following points regarding the specified wheels.

- The wheel rims should be checked for cracks, bends or warpage, and the spokes for looseness or damage before each ride. If any damage is found, have a Yamaha dealer replace the wheel. Do not attempt even the smallest repair to the wheel. A deformed or cracked wheel must be replaced.
- The wheel should be balanced whenever either the tire or wheel has been changed or replaced. An unbalanced wheel can result in poor performance, adverse handling characteristics, and a shortened tire life.
- Ride at moderate speeds after changing a tire since the tire surface must first be “broken in” for it to develop its optimal characteristics.

## Adjusting the clutch lever free play

EAU22041

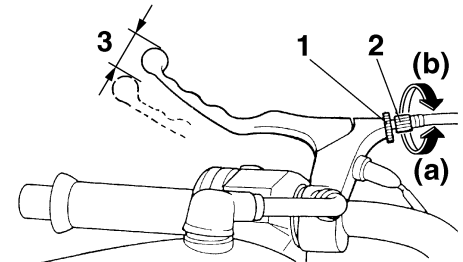

1. Locknut
2. Clutch lever free play adjusting bolt
3. Clutch lever free play

The clutch lever free play should measure 10.0–15.0 mm (0.39–0.59 in) as shown. Periodically check the clutch lever free play and, if necessary, adjust it as follows.

1. Loosen the locknut at the clutch lever.
2. To increase the clutch lever free play, turn the adjusting bolt in direction (a). To decrease the clutch lever free play, turn the adjusting bolt in direction (b).

# PERIODIC MAINTENANCE AND MINOR REPAIR

## NOTE:

If the specified clutch lever free play could be obtained as described above, tighten the locknut and skip the rest of the procedure, otherwise proceed as follows.

3. Fully turn the adjusting bolt at the clutch lever in direction (a) to loosen the clutch cable.
4. Loosen the locknut at the crankcase.

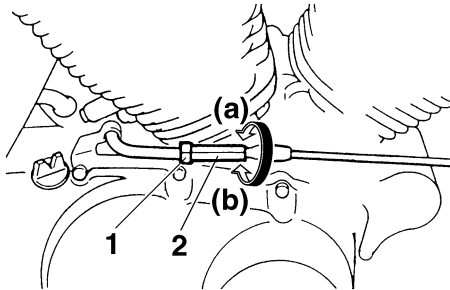

1. Locknut
2. Clutch lever free play adjusting nut (crankcase)

5. To increase the clutch lever free play, turn the adjusting nut in direction (a). To decrease the clutch lever free play, turn the adjusting nut in direction (b).
6. Tighten the locknut at the clutch lever and the crankcase.

## Adjusting the brake lever free play

EAU22092

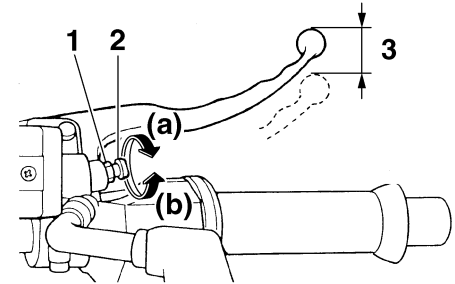

1. Locknut
2. Brake lever free play adjusting screw
3. Brake lever free play

The brake lever free play should measure 2.0–5.0 mm (0.08–0.20 in) as shown. Periodically check the brake lever free play and, if necessary, adjust it as follows.

1. Loosen the locknut at the brake lever.
2. To increase the brake lever free play, turn the adjusting screw in direction (a). To decrease the brake lever free play, turn the adjusting screw in direction (b).
3. Tighten the locknut.

# PERIODIC MAINTENANCE AND MINOR REPAIR

## **WARNING**

EWA10630

- After adjusting the brake lever free play, check the free play and make sure that the brake is working properly.
- A soft or spongy feeling in the brake lever can indicate the presence of air in the hydraulic system. If there is air in the hydraulic system, have a Yamaha dealer bleed the system before operating the motorcycle. Air in the hydraulic system will diminish the braking performance, which may result in loss of control and an accident.

## Adjusting the brake pedal position and free play

EAU22201

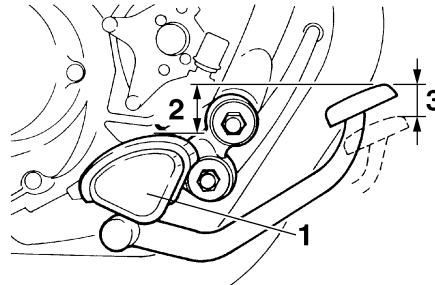

1. Footrest
2. Distance between brake pedal and footrest
3. Brake pedal free play

## **WARNING**

EWA10670

It is advisable to have a Yamaha dealer make these adjustments.

### Brake pedal position

The top of the brake pedal should be positioned approximately 60.0 mm (2.36 in) above the top of the footrest as shown. Periodically check the brake pedal position and, if necessary, adjust it as follows.

1. Loosen the locknut at the brake pedal.
2. To raise the brake pedal, turn the adjusting bolt in direction (a). To lower the brake pedal, turn the adjusting bolt in direction (b).

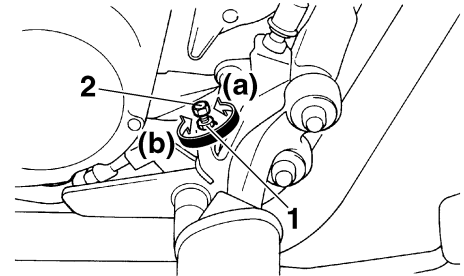

1. Locknut
2. Brake pedal position adjusting bolt
3. Tighten the locknut.

## **WARNING**

EWA11230

After adjusting the brake pedal position, the brake pedal free play must be adjusted.

# PERIODIC MAINTENANCE AND MINOR REPAIR

## Brake pedal free play

The brake pedal free play should measure 20.0–30.0 mm (0.79–1.18 in) at the brake pedal end. Periodically check the brake pedal free play and, if necessary, adjust it as follows.

To increase the brake pedal free play, turn the adjusting nut at the brake rod in direction (a). To decrease the brake pedal free play, turn the adjusting nut in direction (b).

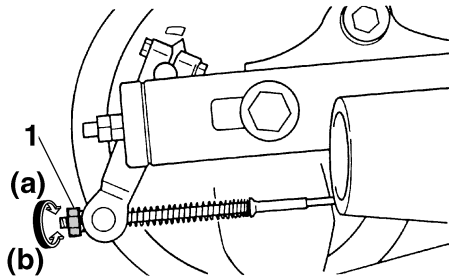

1. Brake pedal free play adjusting nut

EWA10680

### WARNING

- After adjusting the drive chain slack or removing and installing the rear wheel, always check the brake pedal free play.

- If proper adjustment cannot be obtained as described, have a Yamaha dealer make this adjustment.
- After adjusting the brake pedal free play, check the operation of the brake light.

## Adjusting the rear brake light switch

EAU22270

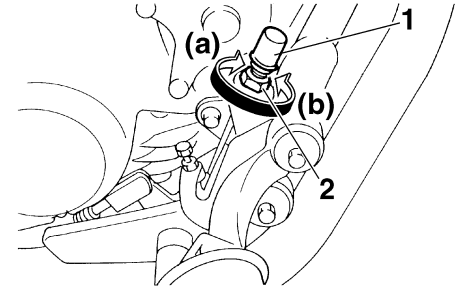

1. Rear brake light switch
2. Rear brake light switch adjusting nut

The rear brake light switch, which is activated by the brake pedal, is properly adjusted when the brake light comes on just before braking takes effect. If necessary, adjust the brake light switch as follows.

Turn the adjusting nut while holding the rear brake light switch in place. To make the brake light come on earlier, turn the adjusting nut in direction (a). To make the brake light come on later, turn the adjusting nut in direction (b).

## Checking the front brake pads and rear brake shoes

EAU22380

The front brake pads and the rear brake shoes must be checked for wear at the intervals specified in the periodic maintenance and lubrication chart.

### Front brake pads

EAU22420

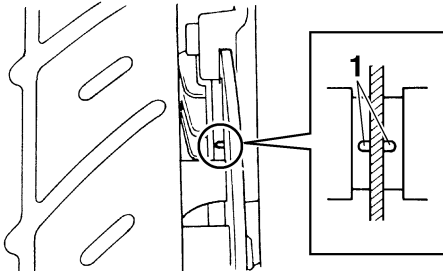

1. Brake pad wear indicator groove

Each front brake pad is provided with a wear indicator groove, which allows you to check the brake pad wear without having to disassemble the brake. To check the brake pad wear, check the wear indicator groove. If a brake pad has worn to the point that the wear

indicator groove has almost disappeared, have a Yamaha dealer replace the brake pads as a set.

### Rear brake shoes

EAU22540

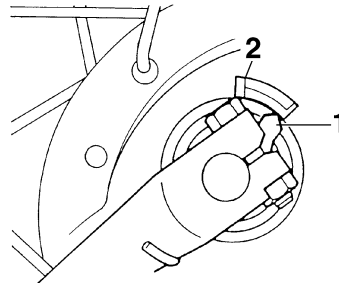

1. Brake shoe wear indicator
2. Brake shoe wear limit line

The rear brake is provided with a wear indicator, which allows you to check the brake shoe wear without having to disassemble the brake. To check the brake shoe wear, check the position of the wear indicator while applying the brake. If a brake shoe has worn to the point that the wear indicator reaches the wear limit line, have a Yamaha dealer replace the brake shoes as a set.

## Checking the front brake fluid level

EAU32343

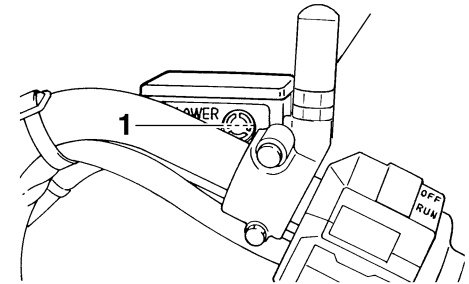

1. Minimum level mark

Insufficient brake fluid may allow air to enter the brake system, possibly causing it to become ineffective.

Before riding, check that the brake fluid is above the minimum level mark and replenish if necessary. A low brake fluid level may indicate worn brake pads and/or brake system leakage. If the brake fluid level is low, be sure to check the brake pads for wear and the brake system for leakage.

Observe these precautions:

# PERIODIC MAINTENANCE AND MINOR REPAIR

---

- When checking the fluid level, make sure that the top of the master cylinder is level by turning the handlebars.
- Use only the recommended quality brake fluid, otherwise the rubber seals may deteriorate, causing leakage and poor braking performance.

## Recommended brake fluid:

DOT 4

- Refill with the same type of brake fluid. Mixing fluids may result in a harmful chemical reaction and lead to poor braking performance.
- Be careful that water does not enter the master cylinder when refilling. Water will significantly lower the boiling point of the fluid and may result in vapor lock.
- Brake fluid may deteriorate painted surfaces or plastic parts. Always clean up spilled fluid immediately.
- As the brake pads wear, it is normal for the brake fluid level to gradually go down. However, if the

brake fluid level goes down suddenly, have a Yamaha dealer check the cause.

## Changing the brake fluid

EAU22720

Have a Yamaha dealer change the brake fluid at the intervals specified in the NOTE after the periodic maintenance and lubrication chart. In addition, have the oil seals of the brake master cylinder and caliper as well as the brake hose replaced at the intervals listed below or whenever they are damaged or leaking.

- Oil seals: Replace every two years.
- Brake hose: Replace every four years.

# PERIODIC MAINTENANCE AND MINOR REPAIR

## Drive chain slack

EAU22760

The drive chain slack should be checked before each ride and adjusted if necessary.

## To check the drive chain slack

EAU22771

1. Place the motorcycle on the side-stand.

### NOTE:

When checking and adjusting the drive chain slack, there should be no weight on the motorcycle.

2. Shift the transmission into the neutral position.
3. Move the rear wheel by pushing the motorcycle to locate the tightest portion of the drive chain, and then measure the drive chain slack as shown.

### Drive chain slack:

30.0–40.0 mm (1.18–1.57 in)

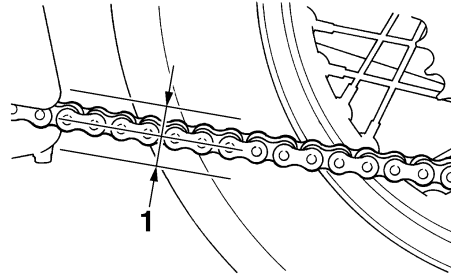

1. Drive chain slack

4. If the drive chain slack is incorrect, adjust it as follows.

## To adjust the drive chain slack

EAU22860

1. Loosen the brake pedal free play adjusting nut.

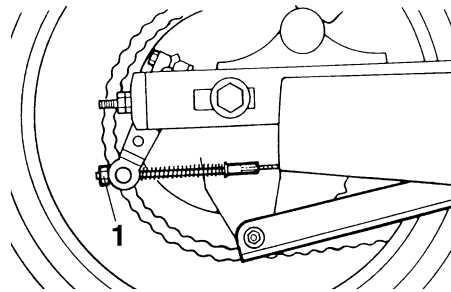

1. Brake pedal free play adjusting nut

2. Remove the cotter pin from the axle nut, and then loosen the axle nut.
3. Loosen the chain puller locknut at each end of the swingarm.
4. To tighten the drive chain, turn the adjusting nut at each end of the swingarm in direction (a). To loosen the drive chain, turn the adjusting nut at each end of the swingarm in direction (b), and then push the rear wheel forward.

### NOTE:

Using the alignment marks on each side of the swingarm, make sure that both chain pullers are in the same position for proper wheel alignment.

# PERIODIC MAINTENANCE AND MINOR REPAIR

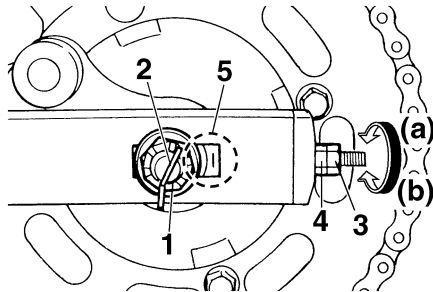

1. Axle nut
2. Cotter pin
3. Chain puller locknut
4. Drive chain slack adjusting nut
5. Alignment marks

ECA10570

6

## CAUTION:

**Improper drive chain slack will overload the engine as well as other vital parts of the motorcycle and can lead to chain slippage or breakage. To prevent this from occurring, keep the drive chain slack within the specified limits.**

5. Tighten the locknuts, and then tighten the axle nut to the specified torque.

## Tightening torque:

Axle nut:  
104 Nm (10.4 m·kgf, 75 ft·lbf)

6. Insert a new cotter pin into the axle nut, and then bend its ends as shown.

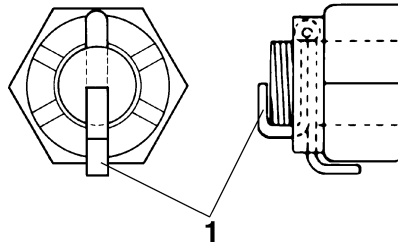

1. Cotter pin

## NOTE:

Make sure that two notches in the axle nut are aligned with the hole through the wheel axle, otherwise further tighten the axle nut until they are.

EWA10700

## WARNING

**Always use a new cotter pin for the axle nut.**

7. Adjust the brake pedal free play. (See page 6-16.)

EWA10660

## WARNING

**After adjusting the brake pedal free play, check the operation of the brake light.**



# PERIODIC MAINTENANCE AND MINOR REPAIR

## Cleaning and lubricating the drive chain

EAU23022

The drive chain must be cleaned and lubricated at the intervals specified in the periodic maintenance and lubrication chart, otherwise it will quickly wear out, especially when riding in dusty or wet areas. Service the drive chain as follows.

### CAUTION:

ECA10581

**The drive chain must be lubricated after washing the motorcycle and riding in the rain.**

1. Clean the drive chain with kerosene and a small soft brush.

### CAUTION:

ECA11120

**To prevent damaging the O-rings, do not clean the drive chain with steam cleaners, high-pressure washers or inappropriate solvents.**

2. Wipe the drive chain dry.
3. Thoroughly lubricate the drive chain with a special O-ring chain lubricant.

### CAUTION:

ECA11110

**Do not use engine oil or any other lubricants for the drive chain, as they may contain substances that could damage the O-rings.**

## Checking and lubricating the cables

EAU23100

The operation of all control cables and the condition of the cables should be checked before each ride, and the cables and cable ends should be lubricated if necessary. If a cable is damaged or does not move smoothly, have a Yamaha dealer check or replace it.

### Recommended lubricant:

Engine oil

EWA10720

### WARNING

**Damage to the outer sheath may interfere with proper cable operation and will cause the inner cable to rust. Replace a damaged cable as soon as possible to prevent unsafe conditions.**

# PERIODIC MAINTENANCE AND MINOR REPAIR

---

## Checking and lubricating the throttle grip and cable

EAU23111

The operation of the throttle grip should be checked before each ride. In addition, the cable should be lubricated at the intervals specified in the periodic maintenance chart.

## Checking and lubricating the brake and shift pedals

EAU23131

The operation of the brake and shift pedals should be checked before each ride, and the pedal pivots should be lubricated if necessary.

### Recommended lubricant:

Lithium-soap-based grease (all-purpose grease)

## Checking and lubricating the brake and clutch levers

EAU23140

The operation of the brake and clutch levers should be checked before each ride, and the lever pivots should be lubricated if necessary.

### Recommended lubricant:

Lithium-soap-based grease (all-purpose grease)

# PERIODIC MAINTENANCE AND MINOR REPAIR

## Checking and lubricating the sidestand

EAU23200

The operation of the sidestand should be checked before each ride, and the sidestand pivot and metal-to-metal contact surfaces should be lubricated if necessary.

EWA10730



If the sidestand does not move up and down smoothly, have a Yamaha dealer check or repair it.

### Recommended lubricant:

Lithium-soap-based grease (all-purpose grease)

## Lubricating the swingarm pivots

EAUM1650

The swingarm pivots must be lubricated at the intervals specified in the periodic maintenance and lubrication chart.

### Recommended lubricant:

Lithium-soap-based grease

## Checking the front fork

EAU23271

The condition and operation of the front fork must be checked as follows at the intervals specified in the periodic maintenance and lubrication chart.

### To check the condition

EWA10750



Securely support the vehicle so that there is no danger of it falling over.

Check the inner tubes for scratches, damage and excessive oil leakage.

### To check the operation

1. Place the vehicle on a level surface and hold it in an upright position.
2. While applying the front brake, push down hard on the handlebars several times to check if the front fork compresses and rebounds smoothly.

# PERIODIC MAINTENANCE AND MINOR REPAIR

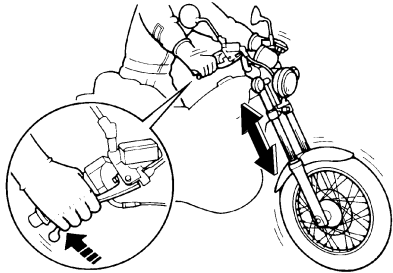

ECA10590

## CAUTION:

If any damage is found or the front fork does not operate smoothly, have a Yamaha dealer check or repair it.

6

## Checking the steering

EAU23280

Worn or loose steering bearings may cause danger. Therefore, the operation of the steering must be checked as follows at the intervals specified in the periodic maintenance and lubrication chart.

1. Place a stand under the engine to raise the front wheel off the ground.

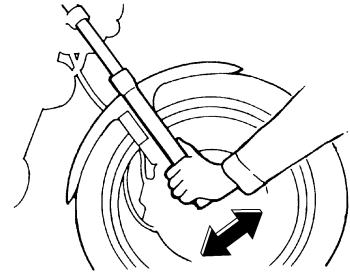

EWA10750

## WARNING

Securely support the vehicle so that there is no danger of it falling over.

2. Hold the lower ends of the front fork legs and try to move them forward and backward. If any free play can be felt, have a Yamaha dealer check or repair the steering.

# PERIODIC MAINTENANCE AND MINOR REPAIR

EAU23290

## Checking the wheel bearings

The front and rear wheel bearings must be checked at the intervals specified in the periodic maintenance and lubrication chart. If there is play in the wheel hub or if the wheel does not turn smoothly, have a Yamaha dealer check the wheel bearings.

EAU23310

## Battery

A poorly maintained battery will corrode and discharge quickly. The electrolyte level, battery lead connections and breather hose routing should be checked before each ride and at the intervals specified in the periodic maintenance and lubrication chart.

### To check the electrolyte level

1. Place the vehicle on a level surface and hold it in an upright position.

**NOTE:** \_\_\_\_\_

Make sure that the vehicle is positioned straight up when checking the electrolyte level.

2. Check the electrolyte level in the battery.

**NOTE:** \_\_\_\_\_

The electrolyte should be between the minimum and maximum level marks.

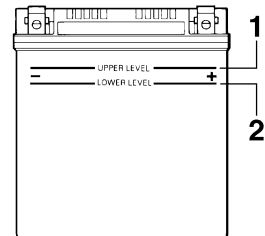

1. Maximum level mark
2. Minimum level mark
3. If the electrolyte is at or below the minimum level mark, add distilled water to raise it to the maximum level mark.

EWA10770

### **WARNING**

- **Electrolyte is poisonous and dangerous since it contains sulfuric acid, which causes severe burns. Avoid any contact with skin, eyes or clothing and always shield your eyes when working near batteries. In case of contact, administer the following FIRST AID.**
  - **EXTERNAL:** Flush with plenty of water.

# PERIODIC MAINTENANCE AND MINOR REPAIR

- **INTERNAL:** Drink large quantities of water or milk and immediately call a physician.
- **EYES:** Flush with water for 15 minutes and seek prompt medical attention.
- Batteries produce explosive hydrogen gas. Therefore, keep sparks, flames, cigarettes, etc., away from the battery and provide sufficient ventilation when charging it in an enclosed space.
- Take care not to spill electrolyte on the drive chain, as this may weaken it, shorten chain life and possibly result in an accident.
- **KEEP THIS AND ALL BATTERIES OUT OF THE REACH OF CHILDREN.**

ECA10610

## CAUTION:

Use only distilled water, as tap water contains minerals that are harmful to the battery.

4. Check and, if necessary, tighten the battery lead connections and correct the breather hose routing.

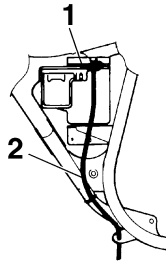

1. Battery
2. Battery breather hose

## To store the battery

1. If the motorcycle will not be used for more than one month, remove the battery, fully charge it, and then place it in a cool, dry place.
2. If the battery will be stored for more than two months, check the specific gravity of the electrolyte at least once a month and fully charge the battery whenever necessary.
3. Fully charge the battery before installation.
4. After installation, make sure that the battery leads are properly connected to the battery terminals and

that the breather hose is properly routed, in good condition, and not obstructed.

ECA10600

## CAUTION:

If the breather hose is positioned in such a way that the frame is exposed to electrolyte or gas expelled from the battery, the frame could suffer structural and external damages.

# PERIODIC MAINTENANCE AND MINOR REPAIR

## Replacing the fuses

EAU23600

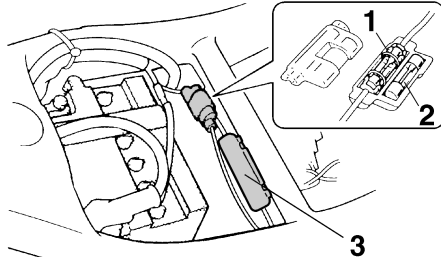

1. Main fuse
2. Spare main fuse
3. Signaling system fuse

The main fuse and the signaling system fuse holders are located under the rider seat. (See page 3-8.)

If a fuse is blown, replace it as follows.

1. Turn the key to "OFF" and turn off the electrical circuit in question.
2. Remove the blown fuse, and then install a new fuse of the specified amperage.

### Specified fuses:

Main fuse:  
20.0 A

Signaling system fuse:  
10.0 A

### CAUTION:

**Do not use a fuse of a higher amperage rating than recommended to avoid causing extensive damage to the electrical system and possibly a fire.**

3. Turn the key to "ON" and turn on the electrical circuit in question to check if the device operates.
4. If the fuse immediately blows again, have a Yamaha dealer check the electrical system.

ECA10640

## Replacing the headlight bulb

EAU23780

This model is equipped with a quartz bulb headlight. If the headlight bulb burns out, replace it as follows.

1. Remove the headlight unit by removing the screws.

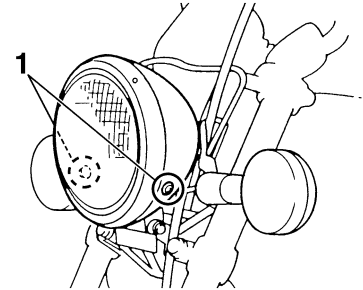

1. Screw

2. Disconnect the headlight coupler, and then remove the bulb cover.

# PERIODIC MAINTENANCE AND MINOR REPAIR

EWA10790

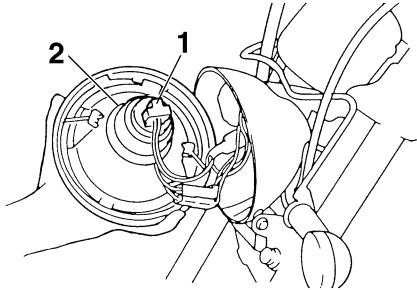

1. Headlight coupler
2. Headlight bulb cover
3. Remove the headlight bulb holder by turning it counterclockwise, and then remove the defective bulb.

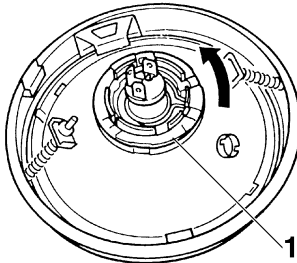

1. Headlight bulb holder

## **WARNING**

Headlight bulbs get very hot. Therefore, keep flammable products away from a lit headlight bulb, and do not touch the bulb until it has cooled down.

4. Place a new headlight bulb into position, and then secure it with the bulb holder.

ECA10660

## **CAUTION:**

Do not touch the glass part of the headlight bulb to keep it free from oil, otherwise the transparency of the glass, the luminosity of the bulb, and the bulb life will be adversely affected. Thoroughly clean off any dirt and fingerprints on the headlight bulb using a cloth moistened with alcohol or thinner.

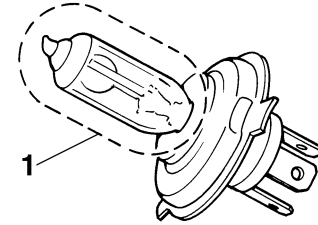

1. Do not touch the glass part of the bulb.
5. Install the headlight bulb cover, and then connect the coupler.
6. Install the headlight unit by installing the screws.
7. Have a Yamaha dealer adjust the headlight beam if necessary.



# PERIODIC MAINTENANCE AND MINOR REPAIR

## Replacing the tail/brake light bulb

EAU24131

1. Remove the tail/brake light lens by removing the screws.

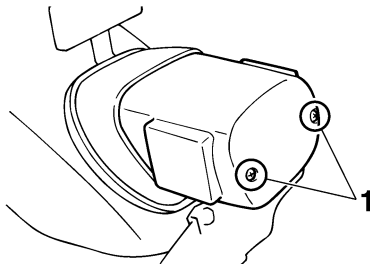

1. Screw

2. Remove the defective bulb by pushing it in and turning it counter-clockwise.

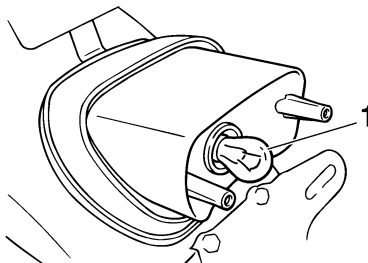

1. Tail/brake light bulb

3. Insert a new bulb into the socket, push it in, and then turn it clockwise until it stops.
4. Install the lens by installing the screws.

**CAUTION:** \_\_\_\_\_

**Do not overtighten the screws, otherwise the lens may break.**

ECA10680

## Replacing a turn signal light bulb

EAU24210

1. Remove the turn signal lens by removing the screws.

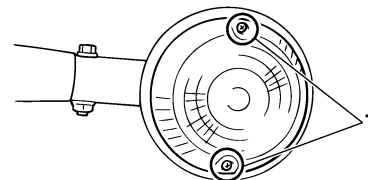

1. Screw

2. Remove the defective bulb by pushing it in and turning it counter-clockwise.

# PERIODIC MAINTENANCE AND MINOR REPAIR

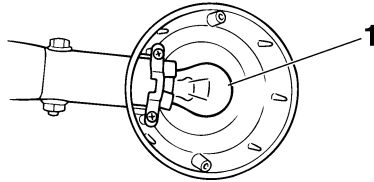

1. Turn signal light bulb
3. Insert a new bulb into the socket, push it in, and then turn it clockwise until it stops.
4. Install the lens by installing the screws.

ECA10680

## **CAUTION:**

**Do not overtighten the screws, otherwise the lens may break.**

EAU24350

## **Supporting the motorcycle**

Since this model is not equipped with a centerstand, follow these precautions when removing the front and rear wheel or performing other maintenance requiring the motorcycle to stand upright. Check that the motorcycle is in a stable and level position before starting any maintenance. A strong wooden box can be placed under the engine for added stability.

a jack either under each side of the frame in front of the rear wheel or under each side of the swingarm.

## **To service the front wheel**

1. Stabilize the rear of the motorcycle by using a motorcycle stand or, if an additional motorcycle stand is not available, by placing a jack under the frame in front of the rear wheel.
2. Raise the front wheel off the ground by using a motorcycle stand.

## **To service the rear wheel**

Raise the rear wheel off the ground by using a motorcycle stand or, if a motorcycle stand is not available, by placing

# PERIODIC MAINTENANCE AND MINOR REPAIR

## Front wheel

EAU24360

### To remove the front wheel

EAU24600

EWA10820

#### **WARNING**

- It is advisable to have a Yamaha dealer service the wheel.
- Securely support the motorcycle so that there is no danger of it falling over.

1. Disconnect the speedometer cable from the front wheel.

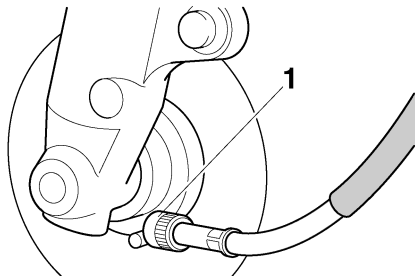

1. Speedometer cable

2. Loosen the front wheel axle pinch bolt, then the wheel axle.

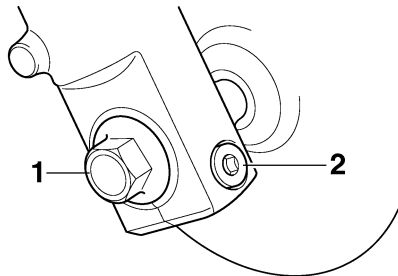

1. Wheel axle
2. Front wheel axle pinch bolt

3. Lift the front wheel off the ground according to the procedure on page 6-31.
4. Pull the wheel axle out, and then remove the wheel.

ECA11070

#### **CAUTION:**

**Do not apply the brake after the wheel has been removed together with the brake disc, otherwise the brake pads will be forced shut.**

EAU24932

### To install the front wheel

1. Install the speedometer gear unit into the wheel hub so that the projections mesh with the slots.

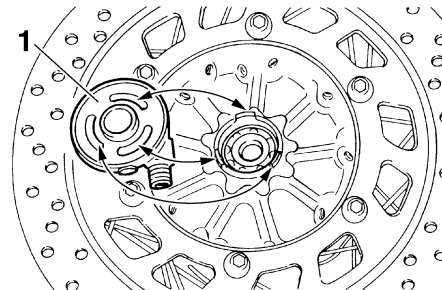

1. Speedometer gear unit

2. Lift the wheel up between the fork legs.

#### **NOTE:**

Make sure that there is enough space between the brake pads before inserting the brake disc and that the slot in the speedometer gear unit fits over the retainer on the fork leg.

# PERIODIC MAINTENANCE AND MINOR REPAIR

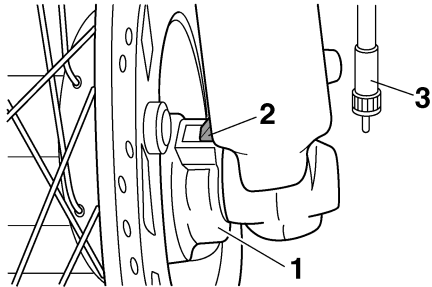

1. Speedometer gear unit
2. Retainer
3. Speedometer cable

3. Insert the wheel axle.
4. Lower the front wheel so that it is on the ground.
5. Tighten the wheel axle to the specified torque.

## Tightening torque:

Wheel axle:  
59 Nm (5.9 m·kgf, 43 ft·lbf)

6. Tighten the front wheel axle pinch bolt to the specified torque.

## Tightening torque:

Front wheel axle pinch bolt:  
20 Nm (2.0 m·kgf, 14 ft·lbf)

7. While applying the front brake, push down hard on the handlebars several times to check if the front fork compresses and rebounds smoothly.
8. Connect the speedometer cable.

## Rear wheel

EAU25080

### To remove the rear wheel

EAU32750

EWA10820

#### **⚠ WARNING**

- It is advisable to have a Yamaha dealer service the wheel.
- Securely support the motorcycle so that there is no danger of it falling over.

1. Remove the axle nut cotter pin.
2. Loosen the chain puller locknut and the drive chain slack adjusting nut on both ends of the swingarm.

# PERIODIC MAINTENANCE AND MINOR REPAIR

EAU32760

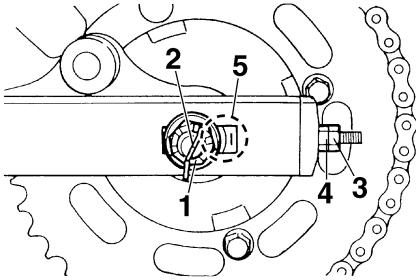

1. Axle nut
2. Axle nut cotter pin
3. Chain puller locknut
4. Drive chain slack adjusting nut
5. Alignment marks

3. Loosen the axle nut and the brake torque rod nut at the brake shoe plate.
4. Lift the rear wheel off the ground according to the procedure on page 6-31.
5. Remove the brake pedal free play adjusting nut, and then disconnect the brake rod at the brake camshaft lever.
6. Disconnect the brake torque rod from the brake shoe plate by removing the nut and the bolt.

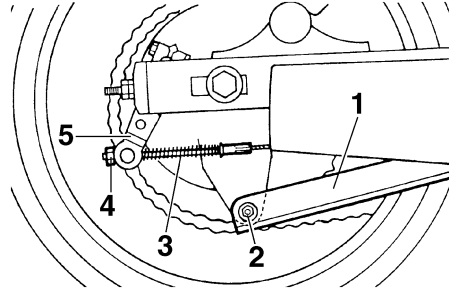

1. Brake torque rod
2. Brake torque rod bolt and nut
3. Brake rod
4. Brake pedal free play adjusting nut
5. Brake camshaft lever

7. Push the wheel forward, and then remove the drive chain from the rear sprocket.

**NOTE:** \_\_\_\_\_  
The drive chain does not need to be disassembled in order to remove and install the rear wheel.

8. Remove the axle nut.
9. Pull the wheel axle out, and then remove the wheel.

## To install the rear wheel

1. Install the drive chain onto the rear sprocket, and then install the wheel by inserting the wheel axle from the right-hand side.
2. Install the brake rod onto the brake camshaft lever, and then install the brake pedal free play adjusting nut onto the brake rod.
3. Connect the brake torque rod to the brake shoe plate by installing the bolt and nut, and then tighten the bolt to the specified torque.

### Tightening torque:

Brake torque rod bolt:  
23 Nm (2.3 m·kgf, 17 ft·lbf)

4. Adjust the drive chain slack. (See page 6-20.)
5. Install the axle nut, and then lower the rear wheel so that it is on the ground.
6. Tighten the axle nut to the specified torque, and then insert a new cotter pin into the axle nut.

# PERIODIC MAINTENANCE AND MINOR REPAIR

---

## Tightening torque:

Axle nut:

104 Nm (10.4 m·kgf, 75 ft·lbf)

EWA10700



## WARNING

**Always use a new cotter pin for the axle nut.**

7. Adjust the brake pedal position and free play. (See page 6-16.)

EWA10660



## WARNING

**After adjusting the brake pedal free play, check the operation of the brake light.**

6

EAU25850

## Troubleshooting

Although Yamaha motorcycles receive a thorough inspection before shipment from the factory, trouble may occur during operation. Any problem in the fuel, compression, or ignition systems, for example, can cause poor starting and loss of power.

The following troubleshooting chart represents a quick and easy procedure for checking these vital systems yourself. However, should your motorcycle require any repair, take it to a Yamaha dealer, whose skilled technicians have the necessary tools, experience, and know-how to service the motorcycle properly.

Use only genuine Yamaha replacement parts. Imitation parts may look like Yamaha parts, but they are often inferior, have a shorter service life and can lead to expensive repair bills.

# PERIODIC MAINTENANCE AND MINOR REPAIR

EAU25931

## Troubleshooting chart

EWA10840



**WARNING**

Keep away open flames and do not smoke while checking or working on the fuel system.

### 1. Fuel

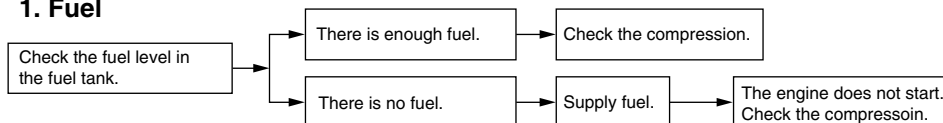

### 2. Compression

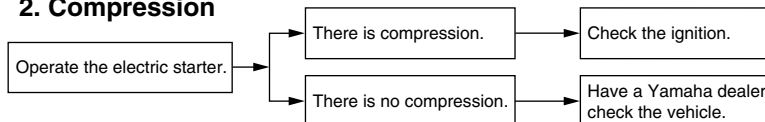

### 3. Ignition

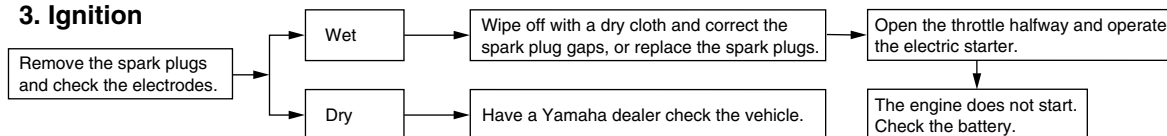

### 4. Battery

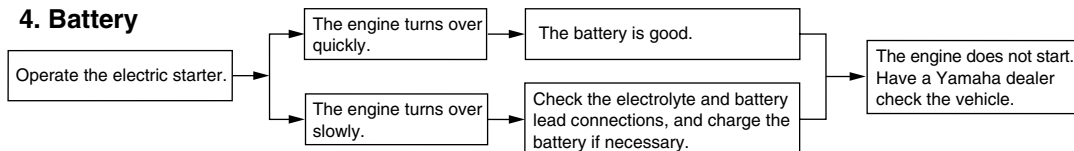

# MOTORCYCLE CARE AND STORAGE

---

EAU26041

## Care

While the open design of a motorcycle reveals the attractiveness of the technology, it also makes it more vulnerable. Rust and corrosion can develop even if high-quality components are used. A rusty exhaust pipe may go unnoticed on a car, however, it detracts from the overall appearance of a motorcycle. Frequent and proper care does not only comply with the terms of the warranty, but it will also keep your motorcycle looking good, extend its life and optimize its performance.

## Before cleaning

1. Cover the muffler outlets with plastic bags after the engine has cooled down.
2. Make sure that all caps and covers as well as all electrical couplers and connectors, including the spark plug caps, are tightly installed.
3. Remove extremely stubborn dirt, like oil burnt onto the crankcase, with a degreasing agent and a brush, but never apply such prod-

ucts onto seals, gaskets, sprockets, the drive chain and wheel axles. Always rinse the dirt and degreaser off with water.

## Cleaning

ECA10770

### CAUTION:

- **Avoid using strong acidic wheel cleaners, especially on spoked wheels. If such products are used on hard-to-remove dirt, do not leave the cleaner on the affected area any longer than instructed. Also, thoroughly rinse the area off with water, immediately dry it, and then apply a corrosion protection spray.**
- **Improper cleaning can damage windshields, cowlings, panels and other plastic parts. Use only a soft, clean cloth or sponge with mild detergent and water to clean plastic.**
- **Do not use any harsh chemical products on plastic parts. Be sure to avoid using cloths or sponges which have been in contact with strong or abrasive**

cleaning products, solvent or thinner, fuel (gasoline), rust removers or inhibitors, brake fluid, antifreeze or electrolyte.

- **Do not use high-pressure washers or steam-jet cleaners since they cause water seepage and deterioration in the following areas: seals (of wheel and swing-arm bearings, fork and brakes), electric components (couplers, connectors, instruments, switches and lights), breather hoses and vents.**
- **For motorcycles equipped with a windshield: Do not use strong cleaners or hard sponges as they will cause dulling or scratching. Some cleaning compounds for plastic may leave scratches on the windshield. Test the product on a small hidden part of the windshield to make sure that it does not leave any marks. If the windshield is scratched, use a quality plastic polishing compound after washing.**



# MOTORCYCLE CARE AND STORAGE

## After normal use

Remove dirt with warm water, a mild detergent, and a soft, clean sponge, and then rinse thoroughly with clean water. Use a toothbrush or bottlebrush for hard-to-reach areas. Stubborn dirt and insects will come off more easily if the area is covered with a wet cloth for a few minutes before cleaning.

## After riding in the rain, near the sea or on salt-sprayed roads

Since sea salt or salt sprayed on roads during winter are extremely corrosive in combination with water, carry out the following steps after each ride in the rain, near the sea or on salt-sprayed roads.

### **NOTE:** \_\_\_\_\_

Salt sprayed on roads in the winter may remain well into spring.

1. Clean the motorcycle with cold water and a mild detergent, after the engine has cooled down.

ECA10790

### **CAUTION:** \_\_\_\_\_

**Do not use warm water since it increases the corrosive action of the salt.**

2. After drying the motorcycle, apply a corrosion protection spray on all metal, including chrome- and nickel-plated, surfaces to prevent corrosion.

### **After cleaning**

1. Dry the motorcycle with a chamois or an absorbing cloth.
2. Immediately dry the drive chain and lubricate it to prevent it from rusting.
3. Use a chrome polish to shine chrome, aluminum and stainless-steel parts, including the exhaust system. (Even the thermally induced discoloring of stainless-steel exhaust systems can be removed through polishing.)

4. To prevent corrosion, it is recommended to apply a corrosion protection spray on all metal, including chrome- and nickel-plated, surfaces.
5. Use spray oil as a universal cleaner to remove any remaining dirt.
6. Touch up minor paint damage caused by stones, etc.
7. Wax all painted surfaces.
8. Let the motorcycle dry completely before storing or covering it.

EWA11130

### **WARNING** \_\_\_\_\_

- **Make sure that there is no oil or wax on the brakes or tires.**
- **If necessary, clean the brake discs and brake linings with a regular brake disc cleaner or acetone, and wash the tires with warm water and a mild detergent. Before riding at higher speeds, test the motorcycle's braking performance and cornering behavior.**

# MOTORCYCLE CARE AND STORAGE

---

ECA10800

## CAUTION:

- Apply spray oil and wax sparingly and make sure to wipe off any excess.
- Never apply oil or wax to any rubber and plastic parts, but treat them with a suitable care product.
- Avoid using abrasive polishing compounds as they will wear away the paint.

## NOTE:

Consult a Yamaha dealer for advice on what products to use.

EAU26211

## Storage

### Short-term

Always store your motorcycle in a cool, dry place and, if necessary, protect it against dust with a porous cover.

ECA10810

## CAUTION:

- Storing the motorcycle in a poorly ventilated room or covering it with a tarp, while it is still wet, will allow water and humidity to seep in and cause rust.
- To prevent corrosion, avoid damp cellars, stables (because of the presence of ammonia) and areas where strong chemicals are stored.

### Long-term

Before storing your motorcycle for several months:

1. Follow all the instructions in the “Care” section of this chapter.
2. Turn the fuel cock lever to “ON”.

3. Drain the carburetor float chambers by loosening the drain bolts; this will prevent fuel deposits from building up. Pour the drained fuel into the fuel tank.
4. Fill up the fuel tank and add fuel stabilizer (if available) to prevent the fuel tank from rusting and the fuel from deteriorating.
5. Perform the following steps to protect the cylinders, piston rings, etc. from corrosion.
  - a. Remove the spark plug caps and spark plugs.
  - b. Pour a teaspoonful of engine oil into each spark plug bore.
  - c. Install the spark plug caps onto the spark plugs, and then place the spark plugs on the cylinder head so that the electrodes are grounded. (This will limit sparking during the next step.)
  - d. Turn the engine over several times with the starter. (This will coat the cylinder walls with oil.)
  - e. Remove the spark plug caps from the spark plugs, and then install the spark plugs and the spark plug caps.

# MOTORCYCLE CARE AND STORAGE

EWA10950

## **WARNING**

**To prevent damage or injury from sparking, make sure to ground the spark plug electrodes while turning the engine over.**

6. Lubricate all control cables and the pivoting points of all levers and pedals as well as of the side-stand/centerstand.
7. Check and, if necessary, correct the tire air pressure, and then lift the motorcycle so that both of its wheels are off the ground. Alternatively, turn the wheels a little every month in order to prevent the tires from becoming degraded in one spot.
8. Cover the muffler outlets with plastic bags to prevent moisture from entering them.
9. Remove the battery and fully charge it. Store it in a cool, dry place and charge it once a month. Do not store the battery in an excessively cold or warm place [less than 0 °C (30 °F) or more than 30

°C (90 °F)]. For more information on storing the battery, see page 6-26.

**NOTE:** \_\_\_\_\_  
Make any necessary repairs before storing the motorcycle.

# SPECIFICATIONS

## Dimensions:

Overall length:  
2190 mm (86.2 in)  
Overall width:  
815 mm (32.1 in)  
Overall height:  
1140 mm (44.9 in)  
Seat height:  
685 mm (27.0 in)  
Wheelbase:  
1490 mm (58.7 in)  
Ground clearance:  
145 mm (5.71 in)  
Minimum turning radius:  
2800 mm (110.2 in)

## Weight:

With oil and fuel:  
147.0 kg (324 lb)

## Engine:

Engine type:  
Air cooled 4-stroke, SOHC  
Cylinder arrangement:  
V-type 2-cylinder  
Displacement:  
249.0 cm<sup>3</sup>  
Bore × stroke:  
49.0 × 66.0 mm (1.93 × 2.60 in)  
Compression ratio:  
10.00 :1  
Starting system:  
Electric starter  
Lubrication system:  
Wet sump

## Engine oil:

Type:  
SAE10W30, SAE10W40, SAE15W40,  
SAE20W40 or SAE20W50

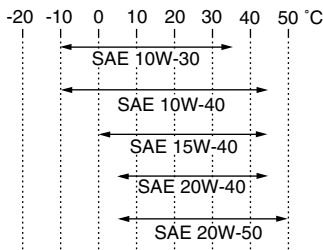

Recommended engine oil grade:  
API service SG type or higher, JASO  
standard MA  
Engine oil quantity:  
Without oil filter element replacement:  
1.40 L (1.48 US qt) (1.23 Imp.qt)  
With oil filter element replacement:  
1.60 L (1.69 US qt) (1.41 Imp.qt)

## Air filter:

Air filter element:  
Wet element

## Fuel:

Recommended fuel:  
Unleaded gasoline only  
Fuel tank capacity:  
9.5 L (2.51 US gal) (2.09 Imp.gal)  
Fuel reserve amount:  
2.6 L (0.69 US gal) (0.57 Imp.gal)

## Carburetor:

Manufacturer:  
MIKUNI  
Type × quantity:  
BDS26 x 1

## Spark plug (s):

Manufacturer/model:  
NGK/C6HSA  
Manufacturer/model:  
DENSO/U20FS-U  
Spark plug gap:  
0.6–0.7 mm (0.024–0.028 in)

## Clutch:

Clutch type:  
Wet, multiple-disc

## Transmission:

Primary reduction system:  
Spur gear  
Primary reduction ratio:  
72/23 (3.130)  
Secondary reduction system:  
Chain drive  
Secondary reduction ratio:  
45/16 (2.812)  
Transmission type:  
Constant mesh 5-speed  
Operation:  
Left foot operation  
Gear ratio:  
1st:  
37/14 (2.643)  
2nd:  
32/19 (1.684)

3rd:  
29/23 (1.261)  
4th:  
26/26 (1.000)  
5th:  
23/28 (0.821)

## Chassis:

Frame type:  
Double cradle  
Caster angle:  
32.00 °  
Trail:  
120.0 mm (4.72 in)

## Front tire:

Type:  
With tube  
Size:  
3.00-18 47P  
Manufacturer/model:  
CHENG SHIN/C-916

## Rear tire:

Type:  
With tube  
Size:  
130/90-15M/C 66P  
Manufacturer/model:  
CHENG SHIN/C-915

## Loading:

Maximum load:  
196 kg (432 lb)  
(Total weight of rider, passenger, cargo and accessories)

## Tire air pressure (measured on cold tires):

Loading condition:  
0–90 kg (0–198 lb)  
Front:  
175 kPa (25 psi) (1.75 kgf/cm<sup>2</sup>)  
Rear:  
200 kPa (29 psi) (2.00 kgf/cm<sup>2</sup>)  
Loading condition:  
90–196 kg (198–432 lb)  
Front:  
200 kPa (29 psi) (2.00 kgf/cm<sup>2</sup>)  
Rear:  
225 kPa (33 psi) (2.25 kgf/cm<sup>2</sup>)

## Front wheel:

Wheel type:  
Spoke wheel  
Rim size:  
18x1.60

## Rear wheel:

Wheel type:  
Spoke wheel  
Rim size:  
15M/C x MT2.75

## Front brake:

Type:  
Single disc brake  
Operation:  
Right hand operation  
Recommended fluid:  
DOT 4

## Rear brake:

Type:  
Drum brake

Operation:  
Right foot operation

## Front suspension:

Type:  
Telescopic fork  
Spring/shock absorber type:  
Coil spring/oil damper  
Wheel travel:  
140.0 mm (5.51 in)

## Rear suspension:

Type:  
Swingarm  
Spring/shock absorber type:  
Coil spring/oil damper  
Wheel travel:  
100.0 mm (3.94 in)

## Electrical system:

Ignition system:  
Transistorized coil ignition (digital)  
Charging system:  
AC magneto

## Battery:

Model:  
YB10L-A  
Voltage, capacity:  
12 V, 10.0 Ah

## Headlight:

Bulb type:  
Halogen bulb

## Bulb voltage, wattage × quantity:

Headlight:  
12 V, 60 W/55.0 W × 1  
Tail/brake light:  
12 V, 5.0 W/21.0 W × 1

# SPECIFICATIONS

---

Front turn signal light:

12 V, 21.0 W × 2

Rear turn signal light:

12 V, 21.0 W × 2

Meter lighting:

14 V, 3.0 W × 1

Neutral indicator light:

14 V, 3.0 W × 1

High beam indicator light:

12 V, 1.7 W × 1

Turn signal indicator light:

14 V, 3.0 W × 1

## **Fuses:**

Main fuse:

20.0 A

Signaling system fuse:

10.0 A

EAU26351

## Identification numbers

Record the key identification number, vehicle identification number and model label information in the spaces provided below for assistance when ordering spare parts from a Yamaha dealer or for reference in case the vehicle is stolen.

KEY IDENTIFICATION NUMBER:

VEHICLE IDENTIFICATION NUMBER:

MODEL LABEL INFORMATION:

## Key identification number

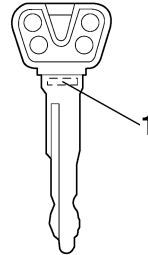

1. Key identification number

The key identification number is stamped into the key. Record this number in the space provided and use it for reference when ordering a new key.

EAU26390

## Vehicle identification number

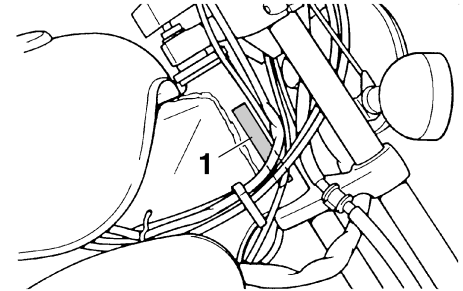

1. Vehicle identification number

The vehicle identification number is stamped into the steering head pipe. Record this number in the space provided.

**NOTE:** \_\_\_\_\_

The vehicle identification number is used to identify your motorcycle and may be used to register your motorcycle with the licensing authority in your area.

\_\_\_\_\_

# CONSUMER INFORMATION

## Model label

EAU26470

EAU26570

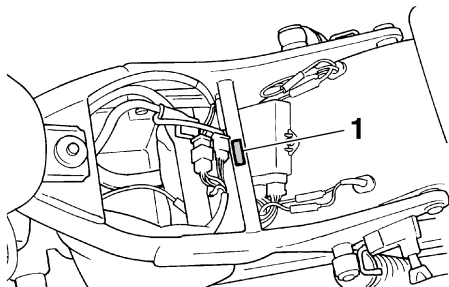

1. Model label

The model label is affixed to the frame under the rider seat. (See page 3-8.) Record the information on this label in the space provided. This information will be needed when ordering spare parts from a Yamaha dealer.

## Motorcycle noise regulation (for Australia)

### TAMPERING WITH NOISE CONTROL SYSTEM PROHIBITED:

Owners are warned that the law may prohibit:

- a. The removal or rendering inoperative by any person other than for purposes of maintenance, repair or replacement, of any device or element of design incorporated into any new vehicle for the purpose of noise control prior to its sale or delivery to the ultimate purchaser or while it is in use; and
- b. The use of the vehicle after such device or element of design has been removed or rendered inoperative by any person.



- A**  
 Air filter element, cleaning ..... 6-9
- B**  
 Battery ..... 6-26  
 Brake and clutch levers, checking  
 and lubricating ..... 6-23  
 Brake and shift pedals, checking  
 and lubricating ..... 6-23  
 Brake fluid, changing ..... 6-19  
 Brake fluid level, checking ..... 6-18  
 Brake lever ..... 3-4  
 Brake lever free play, adjusting ..... 6-15  
 Brake pads and shoes, checking ..... 6-18  
 Brake pedal ..... 3-4  
 Brake pedal position and free play,  
 adjusting ..... 6-16
- C**  
 Cables, checking and lubricating ..... 6-22  
 Carburetor, adjusting ..... 6-11  
 Care ..... 7-1  
 Clutch lever ..... 3-3  
 Clutch lever free play, adjusting ..... 6-14
- D**  
 Dimmer switch ..... 3-2  
 Drive chain, cleaning and lubricating .... 6-22  
 Drive chain slack ..... 6-20
- E**  
 Engine break-in ..... 5-3  
 Engine idling speed ..... 6-11  
 Engine oil and oil filter element ..... 6-7  
 Engine, starting a warm ..... 5-2  
 Engine stop switch ..... 3-3
- F**  
 Front fork, checking ..... 6-24
- Fuel ..... 3-5  
 Fuel cock ..... 3-6  
 Fuel consumption, tips for reducing ..... 5-3  
 Fuel tank cap ..... 3-5  
 Fuses, replacing ..... 6-28
- H**  
 Handlebar switches ..... 3-2  
 Hazard switch ..... 3-3  
 Headlight bulb, replacing ..... 6-28  
 Helmet holder ..... 3-9  
 High beam indicator light ..... 3-1  
 Horn switch ..... 3-3
- I**  
 Identification numbers ..... 9-1  
 Ignition circuit cut-off system ..... 3-11  
 Indicator lights ..... 3-1
- K**  
 Key identification number ..... 9-1
- L**  
 Labels, location of ..... 1-5
- M**  
 Main switch ..... 3-1  
 Model label ..... 9-2
- N**  
 Neutral indicator light ..... 3-1  
 Noise regulation (for Australia) ..... 9-2
- P**  
 Panel, removing and installing ..... 6-5  
 Parking ..... 5-4  
 Part locations ..... 2-1  
 Pass switch ..... 3-2  
 Periodic maintenance and  
 lubrication chart ..... 6-2  
 Pre-operation check list ..... 4-2
- R**  
 Rear brake light switch, adjusting ..... 6-17  
 Rider seat ..... 3-8
- S**  
 Safety information ..... 1-1  
 Shifting ..... 5-2  
 Shift pedal ..... 3-4  
 Shock absorber assemblies, adjusting ... 3-9  
 Sidestand ..... 3-10  
 Sidestand, checking and lubricating .... 6-24  
 Spark plugs, checking ..... 6-5  
 Specifications ..... 8-1  
 Speedometer unit ..... 3-2  
 Starter (choke) lever ..... 3-7  
 Starting and warming up a cold  
 engine ..... 5-1  
 Start switch ..... 3-3  
 Steering, checking ..... 6-25  
 Steering lock ..... 3-8  
 Storage ..... 7-3  
 Supporting the motorcycle ..... 6-31  
 Swingarm pivots, lubricating ..... 6-24
- T**  
 Tail/brake light bulb, replacing ..... 6-30  
 Throttle cable free play, checking ..... 6-12  
 Throttle grip and cable, checking  
 and lubricating ..... 6-23  
 Tires ..... 6-12  
 Tool kit ..... 6-1  
 Troubleshooting ..... 6-35  
 Troubleshooting chart ..... 6-36  
 Turn signal indicator light ..... 3-1  
 Turn signal light bulb, replacing ..... 6-30  
 Turn signal switch ..... 3-2

# INDEX

---

## V

- Valve clearance .....6-12
- Vehicle identification number ..... 9-1

## W

- Wheel bearings, checking.....6-26
- Wheel (front) ..... 6-32
- Wheel (rear) ..... 6-33
- Wheels ..... 6-14





PRINTED ON RECYCLED PAPER

PRINTED IN JAPAN  
2006.05-0.3×1 CR  
(E)