



OWNER'S MANUAL



XVS1100AN

5KS-28199-22

Congratulations on your purchase of the Yamaha XVS1100A. This model is the result of Yamaha's vast experience in the production of fine sporting, touring, and pacesetting racing machines. It represents the high degree of craftsmanship and reliability that have made Yamaha a leader in these fields.

This manual will give you an understanding of the operation, inspection, and basic maintenance of this motorcycle. If you have any questions concerning the operation or maintenance of your motorcycle, please consult a Yamaha dealer.

IMPORTANT MANUAL INFORMATION

Particularly important information is distinguished in this manual by the following notations:



The Safety Alert Symbol means **ATTENTION! BECOME ALERT! YOUR SAFETY IS INVOLVED!**



Failure to follow **WARNING** instructions could result in severe injury or death to the motorcycle operator, a bystander, or a person inspecting or repairing the motorcycle.

CAUTION:

A **CAUTION** indicates special precautions that must be taken to avoid damage to the motorcycle.

NOTE:

A **NOTE** provides key information to make procedures easier or clearer.

NOTE: _____

- This manual should be considered a permanent part of this motorcycle and should remain with it even if the motorcycle is subsequently sold.
 - Yamaha continually seeks advancements in product design and quality. Therefore, while this manual contains the most current product information available at the time of printing, there may be minor discrepancies between your motorcycle and this manual. If you have any questions concerning this manual, please consult your Yamaha dealer.
-

IMPORTANT MANUAL INFORMATION

EW000002

 **WARNING**

PLEASE READ THIS MANUAL CAREFULLY AND COMPLETELY BEFORE OPERATING THIS MOTORCYCLE.

IMPORTANT MANUAL INFORMATION

EAU03337

**XVS1100A
OWNER'S MANUAL
© 2000 by Yamaha Motor Co., Ltd.
1st Edition, July 2000
All rights reserved.
Any reprinting or unauthorized use
without the written permission of
Yamaha Motor Co., Ltd.
is expressly prohibited.
Printed in Japan.**

1 SAFETY INFORMATION	1
2 DESCRIPTION	2
3 INSTRUMENT AND CONTROL FUNCTIONS	3
4 PRE-OPERATION CHECKS	4
5 OPERATION AND IMPORTANT RIDING POINTS	5
6 PERIODIC MAINTENANCE AND MINOR REPAIR	6
7 MOTORCYCLE CARE AND STORAGE	7
8 SPECIFICATIONS	8
9 CONSUMER INFORMATION	9
INDEX	

Safe riding 1-1
Protective apparel 1-3
Modifications 1-3
Loading and accessories 1-3
Gasoline and exhaust gas..... 1-5
Location of important labels 1-7



MOTORCYCLES ARE SINGLE TRACK VEHICLES. THEIR SAFE USE AND OPERATION ARE DEPENDENT UPON THE USE OF PROPER RIDING TECHNIQUES AS WELL AS THE EXPERTISE OF THE OPERATOR. EVERY OPERATOR SHOULD KNOW THE FOLLOWING REQUIREMENTS BEFORE RIDING THIS MOTORCYCLE.

HE OR SHE SHOULD:

1. OBTAIN THOROUGH INSTRUCTIONS FROM A COMPETENT SOURCE ON ALL ASPECTS OF MOTORCYCLE OPERATION.
2. OBSERVE THE WARNINGS AND MAINTENANCE REQUIREMENTS IN THE OWNER'S MANUAL.
3. OBTAIN QUALIFIED TRAINING IN SAFE AND PROPER RIDING TECHNIQUES.
4. OBTAIN PROFESSIONAL TECHNICAL SERVICE AS INDICATED BY THE OWNER'S MANUAL AND/OR WHEN MADE NECESSARY BY MECHANICAL CONDITIONS.

Safe riding

1. Always make pre-operation checks. Careful checks may help prevent an accident.
2. This motorcycle is designed to carry the operator and a passenger.
3. The failure of motorists to detect and recognize motorcycles in traffic is the predominating cause of automobile/motorcycle accidents. Many accidents have been caused by an automobile driver who did not see the motorcycle. Making yourself conspicuous appears to be very effective in reducing the chance of this type of accident.

Therefore:

- a. Wear a brightly colored jacket.
- b. Use extra caution when approaching and passing through intersections, since intersections are the most likely places for motorcycle accidents to occur.
- c. Ride where other motorists can see you. Avoid riding in another motorist's blind spot.

4. Many motorcycle accidents involve inexperienced operators. In fact, many operators who have been involved in accidents do not even have a current motorcycle license.
 - a. Make sure that you are qualified and that you only lend your motorcycle to other qualified operators.
 - b. Know your skills and limits. Staying within your limits may help you to avoid an accident.
 - c. We recommend that you practice riding your motorcycle where there is no traffic until you have become thoroughly familiar with the motorcycle and all of its controls.
5. Many motorcycle accidents have been caused by error of the motorcycle operator. A typical error made by the operator is veering wide on a turn due to EXCESSIVE SPEED or undercornering (insufficient lean angle for the speed).
 - a. Always obey the speed limit and never travel faster than warranted by road and traffic conditions.
 - b. Always signal before turning or changing lanes. Make sure that other motorists can see you.
6. The posture of the operator and passenger is important for proper control.
 - a. The operator should keep both hands on the handlebar and both feet on the operator footrests during operation to maintain control of the motorcycle.
 - b. The passenger should always hold onto the operator, seat strap, or grab bar, if equipped, with both hands and keep both feet on the passenger footrests.
 - c. Never carry a passenger unless he or she can firmly place both feet on the passenger footrests.
7. Never ride under the influence of alcohol or other drugs.
8. This motorcycle is designed for on-road use only, therefore, it is not suitable for off-road use.



SAFETY INFORMATION

Protective apparel

The majority of fatalities from motorcycle accidents are the result of head injuries. The use of a safety helmet is the single most critical factor in the prevention or reduction of head injuries.

1. Always wear an approved helmet.
2. Wear a face shield or goggles. Wind in your unprotected eyes could contribute to an impairment of vision which could delay seeing a hazard.
3. The use of a jacket, heavy boots, trousers, gloves, etc., is effective in preventing or reducing abrasions or lacerations.
4. Never wear loose-fitting clothes, otherwise they could catch on the control levers, footrests, or wheels and cause injury or an accident.
5. Never touch the engine or exhaust system during or after operation. They become very hot and can cause burns. Always wear protective clothing that covers your legs, ankles, and feet.
6. Passengers should also observe the precautions mentioned above.

Modifications

Modifications made to this motorcycle not approved by Yamaha, or the removal of original equipment, may render the motorcycle unsafe for use and may cause severe personal injury. Modifications may also make your motorcycle illegal to use.

Loading and accessories

Adding accessories or cargo to your motorcycle can adversely affect stability and handling if the weight distribution of the motorcycle is changed. To avoid the possibility of an accident, use extreme caution when adding cargo or accessories to your motorcycle. Use extra care when riding a motorcycle that has added cargo or accessories. Here are some general guidelines to follow if loading cargo or adding accessories to your motorcycle:

Loading

The total weight of the operator, passenger, accessories and cargo must not exceed the maximum load limit of 200 kg (441 lb). When loading within this weight limit, keep the following in mind:

1. Cargo and accessory weight should be kept as low and close to the motorcycle as possible. Make sure to distribute the weight as evenly as possible on both sides of the motorcycle to minimize imbalance or instability.
2. Shifting weights can create a sudden imbalance. Make sure that accessories and cargo are securely attached to the motorcycle before riding. Check accessory mounts and cargo restraints frequently.
3. Never attach any large or heavy items to the handlebar, front fork, or front fender. These items, including such cargo as sleeping bags, duffel bags, or tents, can create unstable handling or slow steering response.

Accessories

Genuine Yamaha accessories have been specifically designed for use on this motorcycle. Since Yamaha cannot test all other accessories that may be available, you must personally be responsible for the proper selection, installation and use of non-Yamaha accessories. Use extreme caution when selecting and installing any accessories.

Keep the following guidelines in mind, as well as those provided under “Loading” when mounting accessories.

1. Never install accessories or carry cargo that would impair the performance of your motorcycle. Carefully inspect the accessory before using it to make sure that it does not in any way reduce ground clearance or cornering clearance, limit suspension travel, steering travel or control operation, or obscure lights or reflectors.



SAFETY INFORMATION

- a. Accessories fitted to the handlebar or the front fork area can create instability due to improper weight distribution or aerodynamic changes. If accessories are added to the handlebar or front fork area, they must be as lightweight as possible and should be kept to a minimum.
 - b. Bulky or large accessories may seriously affect the stability of the motorcycle due to aerodynamic effects. Wind may attempt to lift the motorcycle, or the motorcycle may become unstable in cross winds. These accessories may also cause instability when passing or being passed by large vehicles.
 - c. Certain accessories can displace the operator from his or her normal riding position. This improper position limits the freedom of movement of the operator and may limit control ability, therefore, such accessories are not recommended.
2. Use caution when adding electrical accessories. If electrical accessories exceed the capacity of the motorcycle's electrical system, an electric failure could result, which could cause a dangerous loss of lights or engine power.

Gasoline and exhaust gas

1. GASOLINE IS HIGHLY FLAMMABLE:
 - a. Always turn the engine off when refueling.
 - b. Take care not to spill any gasoline on the engine or exhaust system when refueling.
 - c. Never refuel while smoking or in the vicinity of an open flame.
2. Never start the engine or let it run for any length of time in a closed area. The exhaust fumes are poisonous and may cause loss of consciousness and death within a short time. Always operate your motorcycle in an area that has adequate ventilation.
3. Always turn the engine off before leaving the motorcycle unattended and remove the key from the main switch. When parking the motorcycle, note the following:

- a. The engine and exhaust system may be hot, therefore, park the motorcycle in a place where pedestrians or children are not likely to touch these hot areas.
 - b. Do not park the motorcycle on a slope or soft ground, otherwise it may fall over.
 - c. Do not park the motorcycle near a flammable source (e.g. a kerosene heater, or near an open flame), otherwise it could catch fire.
4. When transporting the motorcycle in another vehicle, make sure that it is kept upright and that the fuel cock is turned to “ON” or “RES” (for vacuum type) / “OFF” (for manual type). If it should lean over, gasoline may leak out of the carburetor or fuel tank.
 5. If you should swallow any gasoline, inhale a lot of gasoline vapor, or allow gasoline to get into your eyes, see your doctor immediately. If any gasoline spills on your skin or clothing, immediately wash the affected area with soap and water and change your clothes.

SAFETY INFORMATION

EAU02977

Location of important labels

Please read the following important labels carefully before operating this motorcycle.

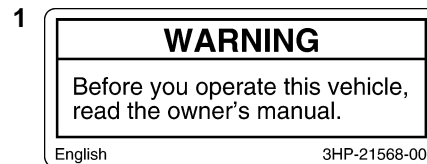
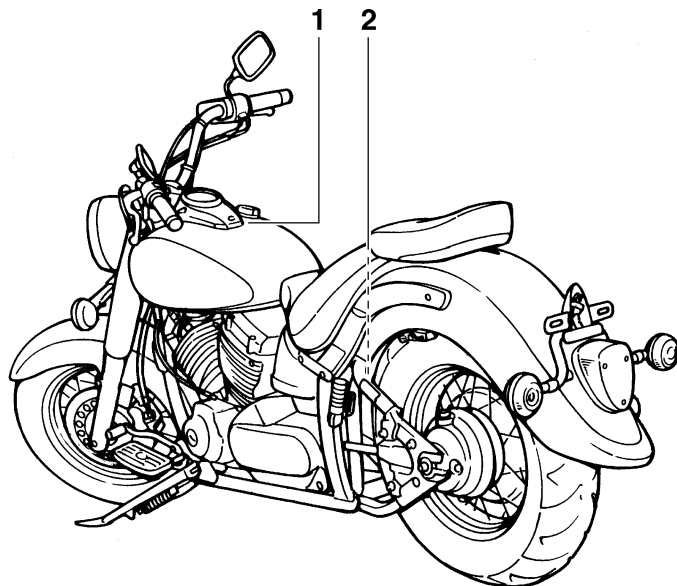

Left view	2-1
Right view.....	2-2
Controls and instruments	2-3

Left view

2

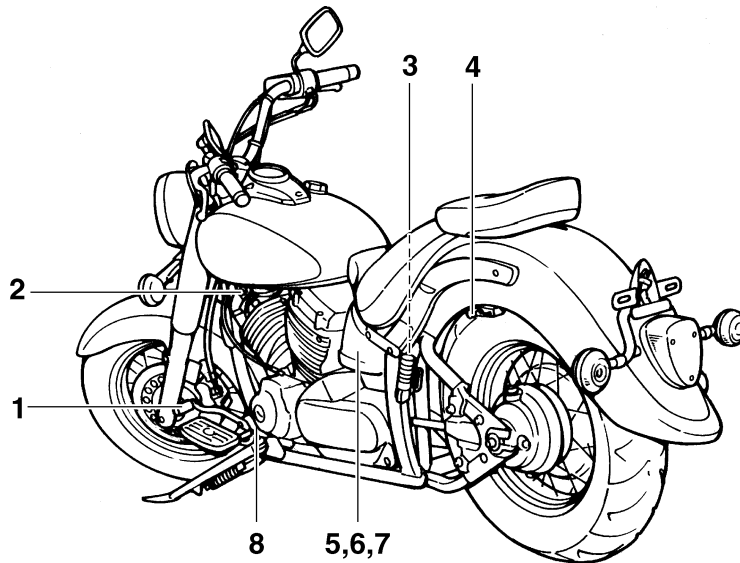

- | | |
|--|-------------|
| 1. Shift pedal | (page 3-5) |
| 2. Fuel cock | (page 3-7) |
| 3. Spring preload adjusting ring (shock absorber assembly) | (page 3-13) |
| 4. Helmet holder | (page 3-11) |
| 5. Storage compartment | (page 3-11) |
| 6. Owner's tool kit | (page 6-1) |
| 7. Fuses | (page 6-27) |
| 8. Engine oil level check window | (page 6-7) |

Right view

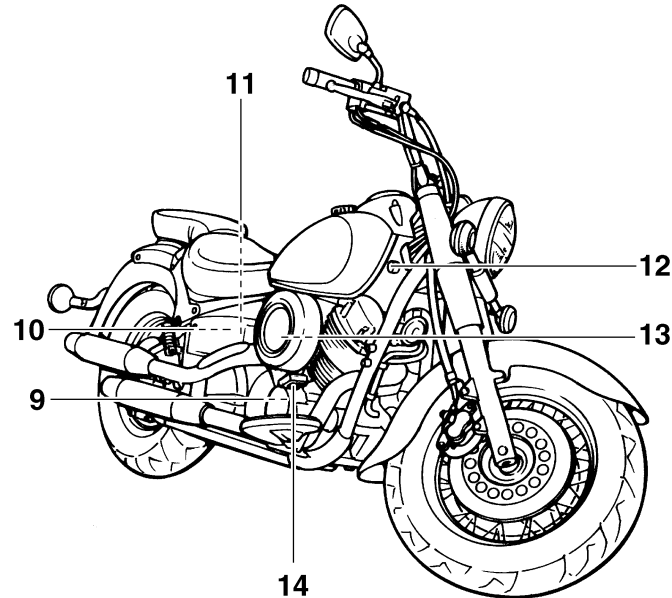

- | | |
|-------------------------------|-------------|
| 9. Engine oil filter element | (page 6-7) |
| 10. Battery | (page 6-25) |
| 11. Main fuse | (page 6-27) |
| 12. Main switch/steering lock | (page 3-1) |
| 13. Air filter element | (page 6-11) |
| 14. Brake pedal | (page 3-6) |

DESCRIPTION

Controls and instruments

2

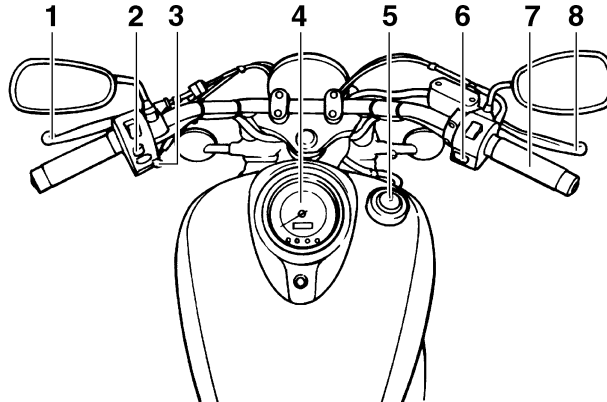

- | | |
|-----------------------------|-------------|
| 1. Clutch lever | (page 3-5) |
| 2. Left handlebar switches | (page 3-3) |
| 3. Starter (choke) lever | (page 3-9) |
| 4. Speedometer unit | (page 3-3) |
| 5. Fuel tank cap | (page 3-6) |
| 6. Right handlebar switches | (page 3-4) |
| 7. Throttle grip | (page 6-13) |
| 8. Brake lever | (page 3-5) |

INSTRUMENT AND CONTROL FUNCTIONS

Main switch/steering lock	3-1
Indicator and warning lights	3-2
Speedometer unit	3-3
Handlebar switches	3-3
Clutch lever	3-5
Shift pedal	3-5
Brake lever	3-5
Brake pedal	3-6
Fuel tank cap	3-6
Fuel	3-7
Fuel cock	3-7
Starter (choke) lever	3-9
Seats	3-9
Helmet holder	3-11
Storage compartment	3-11
Adjusting the shock absorber assembly	3-13
Luggage strap holders	3-15
Sidestand	3-15
Ignition circuit cut-off system	3-16

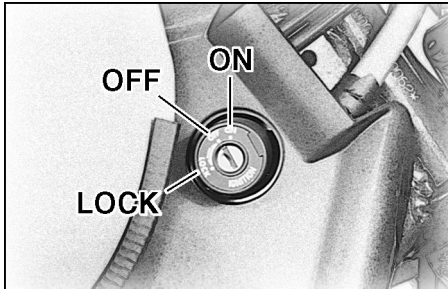

EAU00029

Main switch/steering lock

The main switch/steering lock controls the ignition and lighting systems, and is used to lock the steering. The various positions are described below.

ON

EAU00030

All electrical systems are supplied with power, the headlight, meter lighting and taillight come on, and the engine can be started. The key cannot be removed.

OFF

EAU00038

All electrical systems are off. The key can be removed.

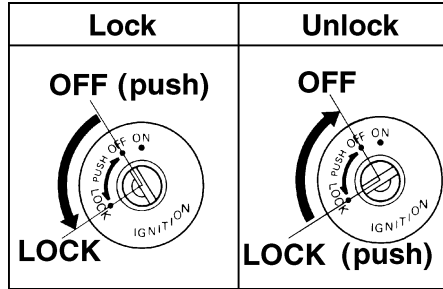

EAU00040

LOCK

The steering is locked, and all electrical systems are off. The key can be removed.

To lock the steering

1. Turn the handlebars all the way to the left.
2. Push the key in from the "OFF" position, and then turn it to "LOCK" while still pushing it.
3. Remove the key.

To unlock the steering

Push the key in, and then turn it to "OFF" while still pushing it.

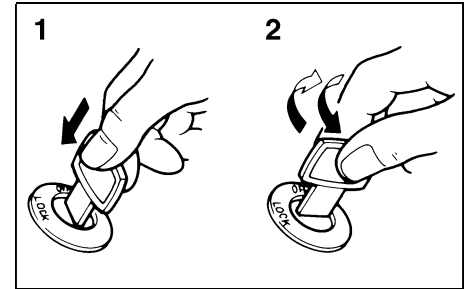

1. Push.
2. Turn.

EW000016

! WARNING

Never turn the key to "OFF" or "LOCK" while the motorcycle is moving, otherwise the electrical systems will be switched off, which may result in loss of control or an accident. Make sure that the motorcycle is stopped before turning the key to "OFF" or "LOCK".

INSTRUMENT AND CONTROL FUNCTIONS

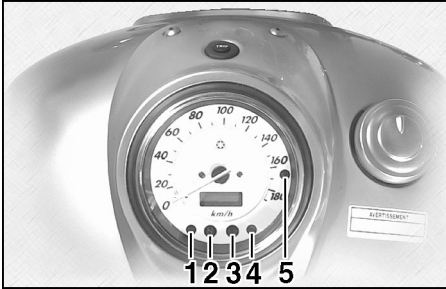

1. Oil level warning light “”
2. Neutral indicator light “N”
3. Turn signal indicator light “ ”
4. Engine trouble warning light “”
5. High beam indicator light “”

EAU03034

Indicator and warning lights

EAU03201

Oil level warning light “”

This warning light comes on when the engine oil level is low.

The electrical circuit of the warning light can be checked according to the following procedure.

1. Set the engine stop switch to “” and turn the key to “ON”.
2. Shift the transmission into the neutral position or pull the clutch lever.

3. Push the start switch. If the warning light does not come on while pushing the start switch, have a Yamaha dealer check the electrical circuit.

NOTE:

Even if the oil level is sufficient, the warning light may flicker when riding on a slope or during sudden acceleration or deceleration, but this is not a malfunction.

EAU00061

Neutral indicator light “N”

This indicator light comes on when the transmission is in the neutral position.

EAU00057

Turn signal indicator light “ ”

This indicator light flashes when the turn signal switch is pushed to the left or right.

EAU03192

Engine trouble warning light “”

This warning light comes on or flashes when an electrical circuit monitoring the engine is defective. When this occurs, have the Yamaha dealer check the self-diagnosis system.

The electrical circuit of the warning light can be checked according to the following procedure.

1. Set the engine stop switch to “”.
2. Turn the key to “ON”. If the warning light does not come on, have a Yamaha dealer check the electrical circuit.

EAU00063

High beam indicator light “”

This indicator light comes on when the high beam of the headlight is switched on.

INSTRUMENT AND CONTROL FUNCTIONS

3

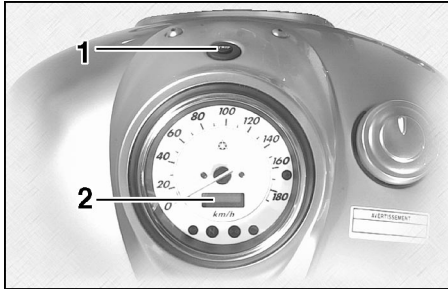

1. "TRIP" button
2. Odometer/tripmeter

EAU03193

Speedometer unit

The speedometer unit is equipped with a digital odometer and a tripmeter. The speedometer shows riding speed. The odometer shows the total distance traveled. The tripmeter shows the distance traveled since it was last set to zero.

Pushing the "TRIP" button switches the display between the odometer mode "ODO" and the tripmeter mode "TRIP".

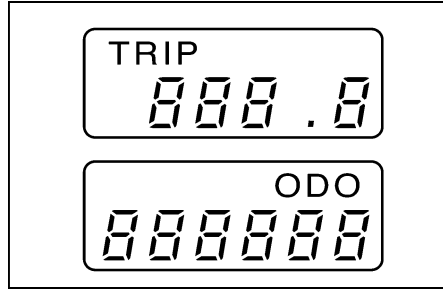

To reset the tripmeter, select it by pushing the "TRIP" button, and then push the "TRIP" button again and hold it down for at least one second. The tripmeter can be used to estimate the distance that can be traveled with a full tank of fuel. This information will enable you to plan future fuel stops.

NOTE: This motorcycle is not equipped with a tachometer; however, it has a built-in speed limiter, which prevents the engine speed from exceeding approximately 6,800 r/min and the vehicle speed from exceeding approximately 175 km/h.

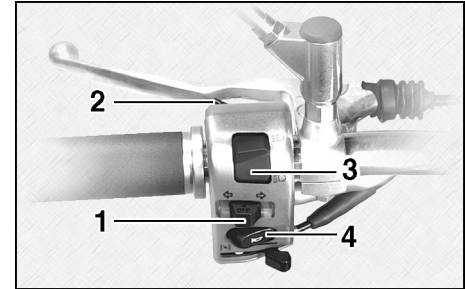

1. Turn signal switch
2. Pass switch "≡D"
3. Dimmer switch
4. Horn switch "📢"

EAU00118

Handlebar switches

EAU00127

Turn signal switch

To signal a right-hand turn, push this switch to "⇨". To signal a left-hand turn, push this switch to "⇧". When released, the switch returns to the center position. To cancel the turn signal lights, push the switch in after it has returned to the center position.

INSTRUMENT AND CONTROL FUNCTIONS

Pass switch “≡○”

EAU00119

Press this switch to flash the headlight.

Dimmer switch

EAU00121

Set this switch to “≡○” for the high beam and to “≡○” for the low beam.

Horn switch “📢”

EAU00129

Press this switch to sound the horn.

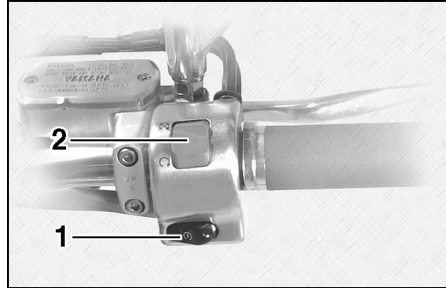

1. Start switch “📢”
2. Engine stop switch

Engine stop switch

EAU00138

Set this switch to “⊗” to stop the engine in case of an emergency, such as when the motorcycle overturns or when the throttle cable is stuck.

Start switch “📢”

EAU00143

Push this switch to crank the engine with the starter.

CAUTION:

See page 5-1 for starting instructions prior to starting the engine.

INSTRUMENT AND CONTROL FUNCTIONS

3

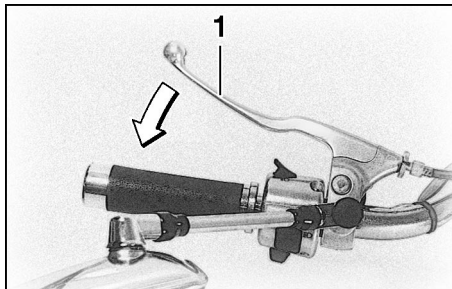

1. Clutch lever

EAU00152

Clutch lever

The clutch lever is located at the left handlebar grip. To disengage the clutch, pull the lever toward the handlebar grip. To engage the clutch, release the lever. The lever should be pulled rapidly and released slowly for smooth clutch operation.

The clutch lever is equipped with a clutch switch, which is part of the ignition circuit cut-off system. (See page 3-16 for an explanation of the ignition circuit cut-off system.)

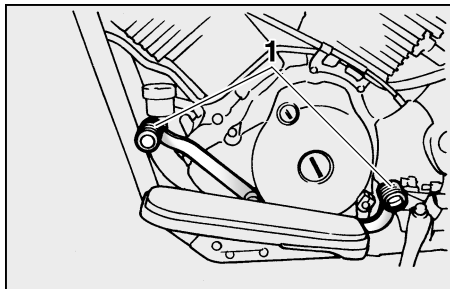

1. Shift pedal

EAU01215

Shift pedal

The shift pedal is located on the left side of the engine and is used in combination with the clutch lever when shifting the gears of the 5-speed constant-mesh transmission equipped on this motorcycle.

NOTE: _____
Use your toes or heel to shift up and your toes to shift down.

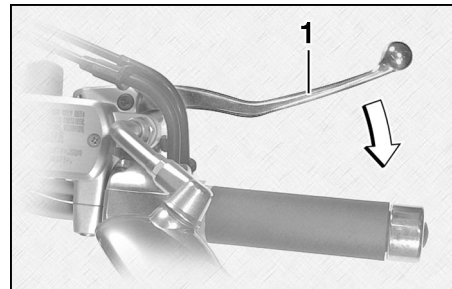

1. Brake lever

EAU00158

Brake lever

The brake lever is located at the right handlebar grip. To apply the front brake, pull the lever toward the handlebar grip.

INSTRUMENT AND CONTROL FUNCTIONS

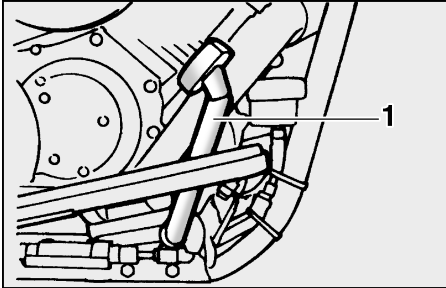

1. Brake pedal

EAU00162

Brake pedal

The brake pedal is on the right side of the motorcycle. To apply the rear brake, press down on the brake pedal.

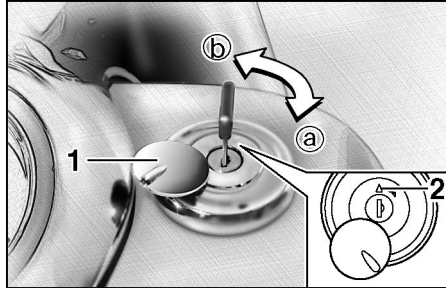

1. Fuel tank cap lock cover
2. "△" mark
 - a. Unlock.
 - b. Lock.

EAU02917

Fuel tank cap

To remove the fuel tank cap

Slide the lock cover open, insert the key into the lock, and then turn it 1/4 turn clockwise. The lock will be released and the fuel tank cap can be removed.

To install the fuel tank cap

1. Insert the fuel tank cap into the tank opening with the key inserted in the lock and with the "△" mark facing forward.

2. Turn the key counterclockwise to the original position, remove it, and then close the lock cover.

NOTE:

The fuel tank cap cannot be installed unless the key is in the lock. In addition, the key cannot be removed if the cap is not properly installed and locked.

EW000024



WARNING

Make sure that the fuel tank cap is properly installed before riding.

INSTRUMENT AND CONTROL FUNCTIONS

3

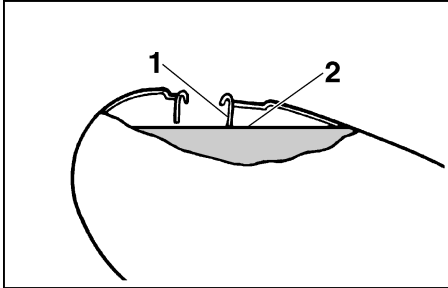

1. Fuel tank filler tube
2. Fuel level

EAU001183

Fuel

Make sure that there is sufficient fuel in the tank. Fill the fuel tank to the bottom of the filler tube as shown in the illustration.

EW000130

! WARNING

- Do not overfill the fuel tank, otherwise it may overflow when the fuel warms up and expands.
- Avoid spilling fuel on the hot engine.

EAU00185

CAUTION:

Immediately wipe off spilled fuel with a clean, dry, soft cloth, since fuel may deteriorate painted surfaces or plastic parts.

EAU00192

Recommended fuel:

Regular gasoline

For Australia:

Unleaded fuel only

Fuel tank capacity:

Total amount:

17 L

Reserve amount:

45 L

Off position

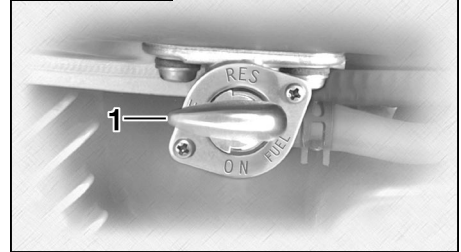

1. Pointed end positioned over "OFF"

EAU02969

Fuel cock

The fuel cock supplies fuel from the tank to the carburetors while also filtering it.

The fuel cock lever positions are explained as follows and shown in the illustrations.

OFF

With the fuel cock lever in this position, fuel will not flow. Always turn the fuel cock lever to this position when the engine is not running.

INSTRUMENT AND CONTROL FUNCTIONS

Normal position

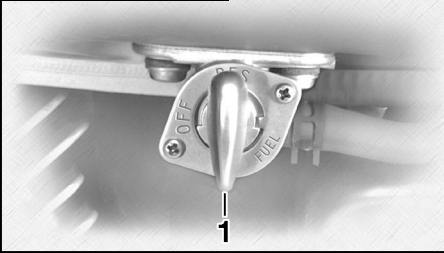

1. Pointed end positioned over "ON"

ON

With the fuel cock lever in this position, fuel flows to the carburetors. Turn the fuel cock lever to this position when starting the engine and riding.

Reserve position

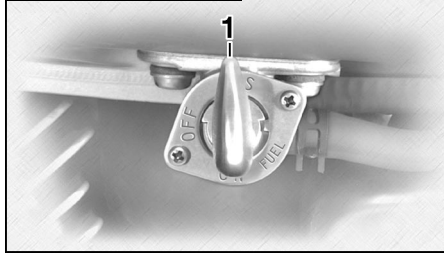

1. Pointed end positioned over "RES"

RES

This indicates reserve. With the fuel cock lever in this position, the fuel reserve is made available. Turn the fuel cock lever to this position if you run out of fuel while riding. When this occurs, refuel as soon as possible and be sure to turn the fuel cock lever back to "ON"!

INSTRUMENT AND CONTROL FUNCTIONS

3

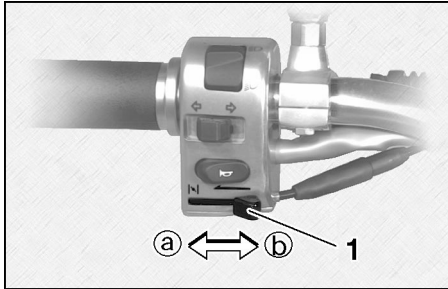

1. Starter (choke) lever

EAU02973

Starter (choke) lever

Starting a cold engine requires a richer air-fuel mixture, which is supplied by the starter (choke).

Move the lever in direction ① to turn on the starter (choke).

Move the lever in direction ② to turn off the starter (choke).

ECA00038

CAUTION:

Do not use the starter (choke) for more than 3 minutes as the exhaust pipe may discolor from excessive heat. In addition, extended use of the starter (choke) will cause after-burning. If this occurs, turn off the starter (choke).

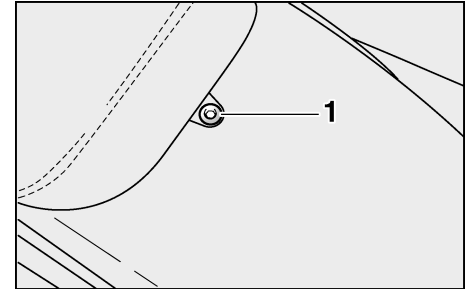

1. Bolt

EAU03202

Seats

Passenger seat

To remove the passenger seat

Remove the bolt, and then pull the passenger seat up.

INSTRUMENT AND CONTROL FUNCTIONS

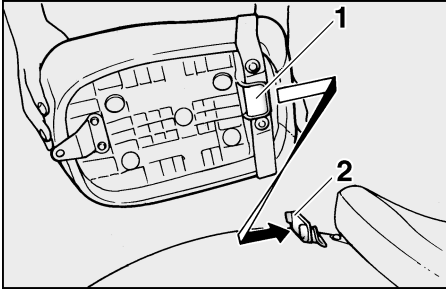

1. Projection
2. Seat holder

To install the passenger seat

Insert the projection on the front of the passenger seat into the holder as shown, place the seat in the original position, and then install the bolt.

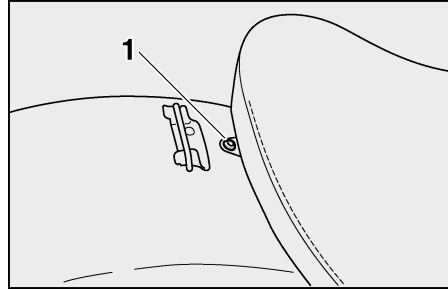

1. Bolt

Rider seat

To remove the rider seat

1. Remove the passenger seat.
2. Remove the bolt, and then pull the rider seat up.

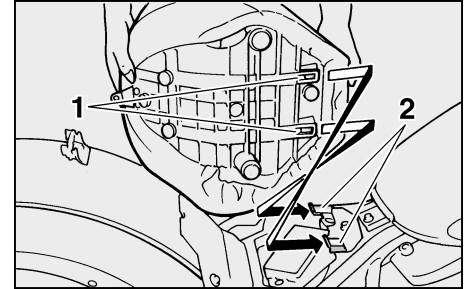

1. Projection (× 2)
2. Seat holder (× 2)

To install the rider seat

1. Insert the projections on the front of the rider seat into the holders as shown, place the seat in the original position, and then install the bolt.
2. Install the passenger seat.

NOTE: _____
Make sure that the seats are properly secured before riding.

INSTRUMENT AND CONTROL FUNCTIONS

3

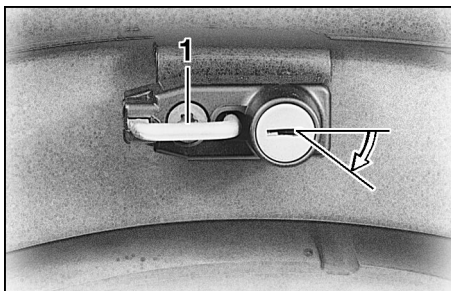

1. Helmet holder

EAU00260

Helmet holder

To open the helmet holder, insert the key into the lock, and then turn the key as shown.

To lock the helmet holder, place it in the original position, and then remove the key.

EW000030

WARNING

Never ride with a helmet attached to the helmet holder, since the helmet may hit objects, causing loss of control and possibly an accident.

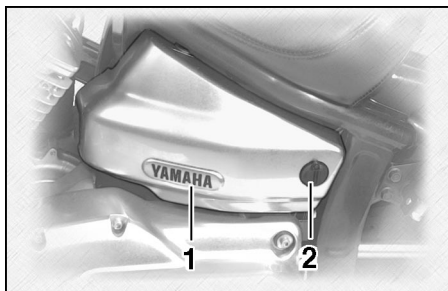

1. Storage compartment cover
2. Storage compartment lock

EAU01869

Storage compartment

The storage compartment is located on the left side of the motorcycle.

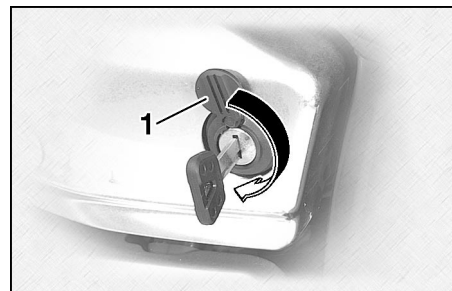

1. Storage compartment lock cover

To open the storage compartment

1. Slide the lock cover open, insert the key into the lock, and then turn it clockwise.

INSTRUMENT AND CONTROL FUNCTIONS

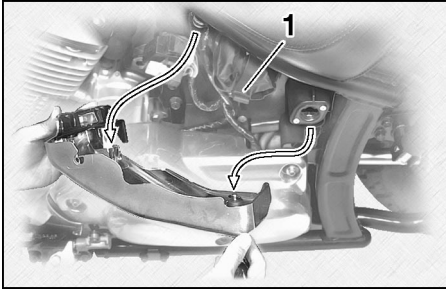

1. Storage compartment cover

2. Pull the storage compartment cover out as shown.

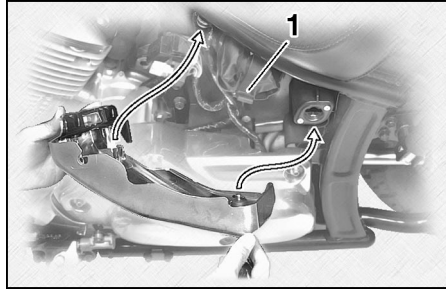

1. Storage compartment cover

To close the storage compartment

1. Place the storage compartment cover in its original position as shown.
2. Turn the key counterclockwise, remove it, and then close the lock cover.

INSTRUMENT AND CONTROL FUNCTIONS

Adjusting the shock absorber assembly

EAU03194

The shock absorber assembly is located under the rider seat and is equipped with a spring preload adjusting ring.

EC000015

CAUTION:

Never attempt to turn an adjusting mechanism beyond the maximum or minimum settings.

Adjust the spring preload as follows.

1. Remove the rider seat. (See page 3-10 for rider seat removal and installation procedures.)

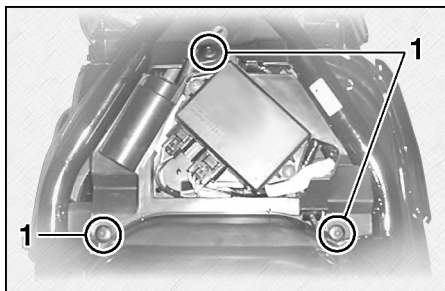

1. Quick fastener (× 3)

2. Remove each quick fastener from the ignitor unit panel by pushing the center in with a screwdriver, then pulling the fastener out.

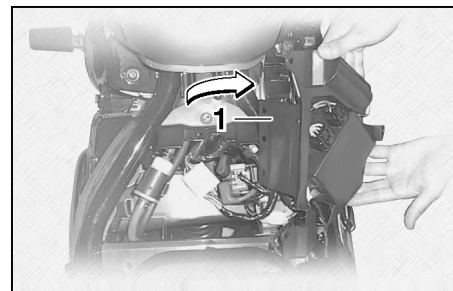

1. Ignitor unit panel

3. Pull the ignitor unit panel out to the right.

INSTRUMENT AND CONTROL FUNCTIONS

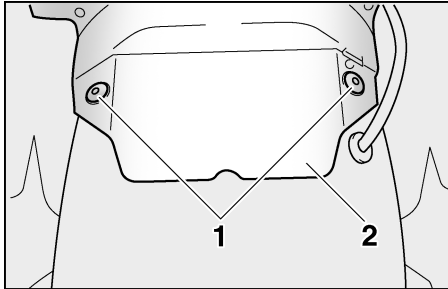

1. Quick fastener (× 2)
 2. Mudguard
4. Remove the mudguard by removing each quick fastener.

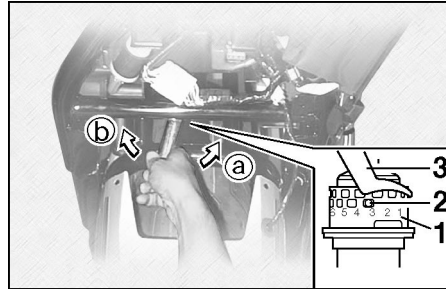

1. Spring preload adjusting ring
 2. Position indicator
 3. Special wrench
5. To increase the spring preload and thereby harden the suspension, turn the adjusting ring in direction Ⓐ. To decrease the spring preload and thereby soften the suspension, turn the adjusting ring in direction Ⓑ.

- NOTE:**
- Align the appropriate notch in the adjusting ring with the position indicator on the shock absorber.
 - Use the special wrench included in the owner's tool kit to make the adjustment.

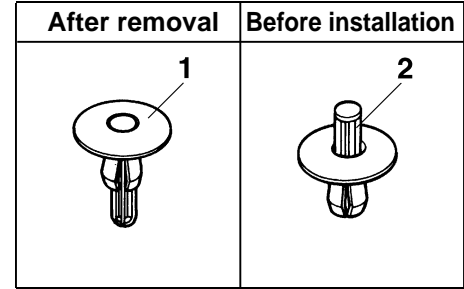

1. Quick fastener
2. Pin

Setting	Minimum (soft)		Standard	Maximum (hard)			
	1	2	3	4	5	6	7
Setting	1	2	3	4	5	6	7

6. Install the mudguard and ignitor unit panel by installing the quick fasteners.

NOTE: To install a quick fastener, push the pin back so that it will protrude from the fastener head, and then insert the fastener and push the protruding pin in until it is flush with the fastener head.

7. Install the rider seat.

INSTRUMENT AND CONTROL FUNCTIONS

EAU00315

⚠ WARNING

This shock absorber contains highly pressurized nitrogen gas. For proper handling, read and understand the following information before handling the shock absorber. The manufacturer cannot be held responsible for property damage or personal injury that may result from improper handling.

- Do not tamper with or attempt to open the gas cylinder.
- Do not subject the shock absorber to an open flame or other high heat sources, otherwise it may explode due to excessive gas pressure.
- Do not deform or damage the gas cylinder in any way, as this will result in poor damping performance.
- Always have a Yamaha dealer service the shock absorber.

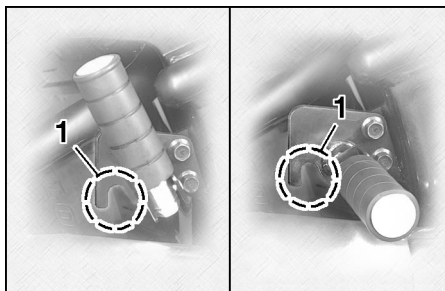

1. Luggage strap holder (x 2)

EAU01172

Luggage strap holders

There is a luggage strap holder on each passenger footrest.

EAU00330

Sidestand

The sidestand is located on the left side of the frame. Raise the sidestand or lower it with your foot while holding the motorcycle upright.

NOTE:

The built-in sidestand switch is part of the ignition circuit cut-off system, which cuts the ignition in certain situations. (See further down for an explanation of the ignition circuit cut-off system.)

EW000044

WARNING

The motorcycle must not be ridden with the sidestand down, or if the sidestand cannot be properly moved up (or does not stay up), otherwise the sidestand could contact the ground and distract the operator, resulting in a possible loss of control. Yamaha's ignition circuit cut-off system has been designed to assist the operator in fulfilling the responsibility of raising the sidestand before starting off. Therefore, check this system regularly as described below and have a Yamaha dealer repair it if it does not function properly.

EAU03720

Ignition circuit cut-off system

The ignition circuit cut-off system (comprising the sidestand switch, clutch switch and neutral switch) has the following functions.

- It prevents starting when the transmission is in gear and the sidestand is up, but the clutch lever is not pulled.
- It prevents starting when the transmission is in gear and the clutch lever is pulled, but the sidestand is still down.
- It cuts the running engine when the transmission is in gear and the sidestand is moved down.

Periodically check the operation of the ignition circuit cut-off system according to the following procedure.

EW000045

WARNING

If a malfunction is noted, have a Yamaha dealer check the system before riding.

INSTRUMENT AND CONTROL FUNCTIONS

3

With the engine turned off:
1. Move the sidestand down.
2. Make sure that the engine stop switch is set to “O”.
3. Turn the key to “ON”.
4. Shift the transmission into the neutral position.
5. Push the start switch.
Does the engine start?

YES NO

NOTE: _____
This check is most reliable if performed with
a warmed-up engine.

The neutral switch may be defective.
The motorcycle should not be ridden until
checked by a Yamaha dealer.

With the engine still running:
6. Move the sidestand up.
7. Keep the clutch lever pulled.
8. Shift the transmission into gear.
9. Move the sidestand down.
Does the engine stall?

YES NO

The sidestand switch may be defective.
The motorcycle should not be ridden until
checked by a Yamaha dealer.

After the engine has stalled:
10. Move the sidestand up.
11. Keep the clutch lever pulled.
12. Push the start switch.
Does the engine start?

YES NO

The clutch switch may be defective.
The motorcycle should not be ridden until
checked by a Yamaha dealer.

The system is OK. **The motorcycle can be ridden.**

Pre-operation check list 4-1

PRE-OPERATION CHECKS

The condition of a vehicle is the owner's responsibility. Vital components can start to deteriorate quickly and unexpectedly, even if the vehicle remains unused (for example, as a result of exposure to the elements). Any damage, fluid leakage or loss of tire air pressure could have serious consequences. Therefore, it is very important, in addition to a thorough visual inspection, to check the following points before each ride.

Pre-operation check list

ITEM	CHECKS	PAGE
Fuel	<ul style="list-style-type: none">• Check fuel level in fuel tank.• Refuel if necessary.• Check fuel line for leakage.	3-7
Engine oil	<ul style="list-style-type: none">• Check oil level in engine.• If necessary, add recommended oil to specified level.• Check vehicle for oil leakage.	6-7-6-9
Final gear oil	<ul style="list-style-type: none">• Check vehicle for oil leakage.	6-9-6-10
Front brake	<ul style="list-style-type: none">• Check operation.• If soft or spongy, have Yamaha dealer bleed hydraulic system.• Check lever free play.• Adjust if necessary.• Check fluid level in reservoir.• If necessary, add recommended brake fluid to specified level.• Check hydraulic system for leakage.	6-17, 6-19-6-20
Rear brake	<ul style="list-style-type: none">• Check operation.• If soft or spongy, have Yamaha dealer bleed hydraulic system.• Check fluid level in reservoir.• If necessary, add recommended brake fluid to specified level.• Check hydraulic system for leakage.	6-18-6-20
Clutch	<ul style="list-style-type: none">• Check operation.• Lubricate cable if necessary.• Check lever free play.• Adjust if necessary.	6-16

4

PRE-OPERATION CHECKS

ITEM	CHECKS	PAGE
Throttle grip	<ul style="list-style-type: none"> • Make sure that operation is smooth. • Lubricate throttle grip, housing and cables if necessary. • Check free play. • If necessary, have Yamaha dealer make adjustment. 	6-13, 6-21
Control cables	<ul style="list-style-type: none"> • Make sure that operation is smooth. • Lubricate if necessary. 	6-21
Wheels and tires	<ul style="list-style-type: none"> • Check for damage. • Check tire condition and tread depth. • Check air pressure. • Correct if necessary. 	6-13–6-15
Brake and shift pedals	<ul style="list-style-type: none"> • Make sure that operation is smooth. • Lubricate pedal pivoting points if necessary. 	6-22
Brake and clutch levers	<ul style="list-style-type: none"> • Make sure that operation is smooth. • Lubricate lever pivoting points if necessary. 	6-22
Sidestand	<ul style="list-style-type: none"> • Make sure that operation is smooth. • Lubricate pivot if necessary. 	6-22
Chassis fasteners	<ul style="list-style-type: none"> • Make sure that all nuts, bolts and screws are properly tightened. • Tighten if necessary. 	—
Instruments, lights, signals and switches	<ul style="list-style-type: none"> • Check operation. • Correct if necessary. 	—
Engine stop switch	<ul style="list-style-type: none"> • Check operation. 	3-4
Sidestand switch	<ul style="list-style-type: none"> • Check operation of ignition circuit cut-off system. • If system is defective, have Yamaha dealer check vehicle. 	3-15

NOTE: _____
 Pre-operation checks should be made each time the motorcycle is used. Such an inspection can be accomplished in a very short time; and the added safety it assures is more than worth the time involved.

PRE-OPERATION CHECKS

EWA00033

WARNING

If any item in the Pre-operation check list is not working properly, have it inspected and repaired before operating the motorcycle.

OPERATION AND IMPORTANT RIDING POINTS

Starting and warming up a cold engine	5-1
Starting a warm engine	5-3
Shifting	5-3
Tips for reducing fuel consumption	5-4
Engine break-in	5-4
Parking	5-5

EAU00373

EAU01715*

⚠ WARNING

- Become thoroughly familiar with all operating controls and their functions before riding. Consult a Yamaha dealer regarding any control or function that you do not thoroughly understand.
- Never start the engine or operate it in a closed area for any length of time. Exhaust fumes are poisonous, and inhaling them can cause loss of consciousness and death within a short time. Always make sure that there is adequate ventilation.
- Before starting out, make sure that the sidestand is up. If the sidestand is not raised completely, it could contact the ground and distract the operator, resulting in a possible loss of control.

Starting and warming up a cold engine

In order for the ignition circuit cut-off system to enable starting, one of the following conditions must be met:

- The transmission is in the neutral position.
- The transmission is in gear with the clutch lever pulled and the sidestand up.

EW000054

⚠ WARNING

- Before starting the engine, check the function of the ignition circuit cut-off system according to the procedure described on page 3-17.
- Never ride with the sidestand down.

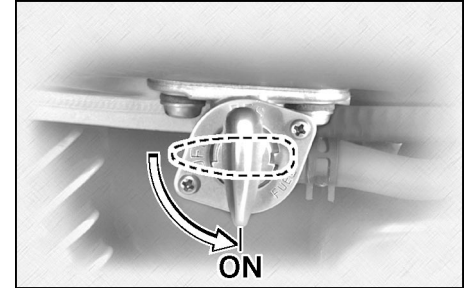

1. Turn the fuel cock lever to “ON”.
2. Turn the key to “ON” and make sure that the engine stop switch is set to “ \bigcirc ”.
3. Shift the transmission into the neutral position.

NOTE:

When the transmission is in the neutral position, the neutral indicator light should be on, otherwise have a Yamaha dealer check the electrical circuit.

OPERATION AND IMPORTANT RIDING POINTS

ECA00023

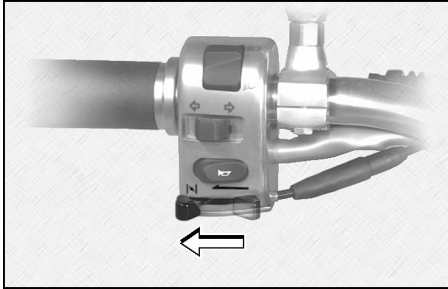

4. Turn the starter (choke) on and completely close the throttle. (See page 3-9 for starter (choke) operation.)
5. Start the engine by pushing the start switch.

NOTE: _____
If the engine fails to start, release the start switch, wait a few seconds, and then try again. Each starting attempt should be as short as possible to preserve the battery. Do not crank the engine more than 10 seconds on any one attempt.

CAUTION: _____

The oil level warning light should come on when the key is turned to “ON”, and then go off after two to three seconds. If the oil level warning light flickers or remains on after starting, immediately stop the engine, and then check the engine oil level and the vehicle for oil leakage. If necessary, add engine oil, and then check the warning light again. If the warning light does not come on when turning the key to “ON”, or if it does not go off after starting the engine with sufficient engine oil, have a Yamaha dealer check the electrical circuit.

6. After starting the engine, move the starter (choke) lever back halfway.

ECA00055

CAUTION: _____

For maximum engine life, always warm the engine up before starting off. Never accelerate hard when the engine is cold!

7. When the engine is warm, turn the starter (choke) off.

NOTE: _____

The engine is warm when it responds normally to the throttle with the starter (choke) turned off.

OPERATION AND IMPORTANT RIDING POINTS

EAU01258

Starting a warm engine

Follow the same procedure as for starting a cold engine with the exception that the starter (choke) is not required when the engine is warm.

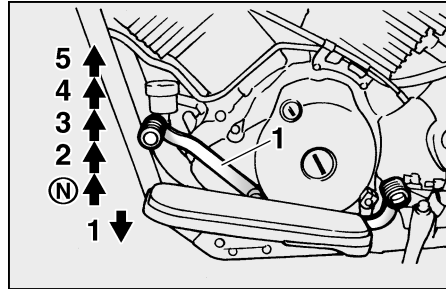

- 1. Shift pedal
- N. Neutral position

EAU00423

Shifting

Shifting gears lets you control the amount of engine power available for starting off, accelerating, climbing hills, etc.

The gear positions are shown in the illustration.

NOTE:

To shift the transmission into the neutral position, press the shift pedal down repeatedly until it reaches the end of its travel, and then slightly raise it.

EC000048

CAUTION:

- Even with the transmission in the neutral position, do not coast for long periods of time with the engine off, and do not tow the motorcycle for long distances. The transmission is properly lubricated only when the engine is running. Inadequate lubrication may damage the transmission.
- Always use the clutch while changing gears to avoid damaging the engine, transmission, and drive train, which are not designed to withstand the shock of forced shifting.

OPERATION AND IMPORTANT RIDING POINTS

Tips for reducing fuel consumption

EAU00424

Fuel consumption depends largely on your riding style. Consider the following tips to reduce fuel consumption:

- Thoroughly warm up the engine.
- Turn the starter (choke) off as soon as possible.
- Shift up swiftly, and avoid high engine speeds during acceleration.
- Do not rev the engine while shifting down, and avoid high engine speeds with no load on the engine.
- Turn the engine off instead of letting it idle for an extended length of time (e.g., in traffic jams, at traffic lights or at railroad crossings).

Engine break-in

EAU01128

There is never a more important period in the life of your engine than the period between 0 and 1,600 km. For this reason, you should read the following material carefully.

Since the engine is brand new, do not put an excessive load on it for the first 1,600 km. The various parts in the engine wear and polish themselves to the correct operating clearances. During this period, prolonged full-throttle operation or any condition that might result in engine overheating must be avoided.

0–1,000 km

EAU01171*

Avoid prolonged operation above 1/3 throttle.

1,000–1,600 km

Avoid prolonged operation above 1/2 throttle.

EC000056*

CAUTION:

After 1,000 km of operation, the engine oil and final gear oil must be changed, and the oil filter element replaced.

1,600 km and beyond

The vehicle can now be operated normally.

EC000049

CAUTION:

If any engine trouble should occur during the engine break-in period, immediately have a Yamaha dealer check the vehicle.

OPERATION AND IMPORTANT RIDING POINTS

EAU00457

Parking

When parking, stop the engine, remove the key from the main switch, and then turn the fuel cock lever to “OFF”.

EW000058

WARNING

- Since the engine and exhaust system can become very hot, park in a place where pedestrians or children are not likely to touch them.
 - Do not park on a slope or on soft ground, otherwise the motorcycle may overturn.
-

PERIODIC MAINTENANCE AND MINOR REPAIR

Owner's tool kit	6-1	Changing the brake fluid	6-20
Periodic maintenance and lubrication chart	6-2	Checking and lubricating the cables	6-21
Removing and installing the panel	6-5	Checking and lubricating the throttle grip and cable	6-21
Checking the spark plugs	6-6	Checking and lubricating the brake and shift pedals	6-22
Engine oil and oil filter element	6-7	Checking and lubricating the brake and clutch levers	6-22
Final gear oil	6-9	Checking and lubricating the sidestand	6-22
Cleaning the air filter element	6-11	Checking the front fork	6-23
Adjusting the carburetors	6-12	Checking the steering	6-23
Adjusting the engine idling speed	6-12	Checking the wheel bearings	6-24
Adjusting the throttle cable free play	6-13	Battery	6-25
Adjusting the valve clearance	6-13	Replacing the fuses	6-27
Tires	6-13	Replacing the headlight bulb	6-29
Spoke wheels	6-15	Replacing a turn signal light bulb or the tail/brake light bulb	6-30
Adjusting the clutch lever free play	6-16	Troubleshooting	6-31
Adjusting the brake lever free play	6-17	Troubleshooting chart	6-32
Adjusting the brake pedal position	6-18		
Adjusting the rear brake light switch	6-18		
Checking the front and rear brake pads	6-19		
Checking the brake fluid level	6-19		

Safety is an obligation of the owner. Periodic inspection, adjustment and lubrication will keep your vehicle in the safest and most efficient condition possible. The most important points of inspection, adjustment, and lubrication are explained on the following pages.

The intervals given in the periodic maintenance and lubrication chart should be simply considered as a general guide under normal riding conditions. However, **DEPENDING ON THE WEATHER, TERRAIN, GEOGRAPHICAL LOCATION, AND INDIVIDUAL USE, THE MAINTENANCE INTERVALS MAY NEED TO BE SHORTENED.**

EAU00464

EW000060

⚠ WARNING

If you are not familiar with motorcycle maintenance work, have a Yamaha dealer do it for you.

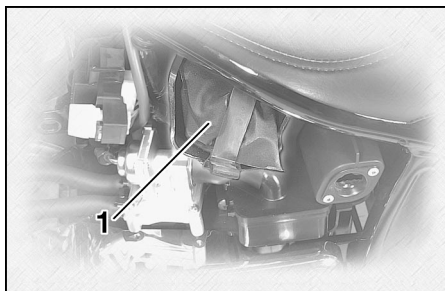

1. Owner's tool kit

EAU01129

Owner's tool kit

The owner's tool kit is located inside the storage compartment. (See page 3-11 for storage compartment opening procedures.)

The service information included in this manual and the tools provided in the owner's tool kit are intended to assist you in the performance of preventive maintenance and minor repairs. However, additional tools such as a torque wrench may be necessary to perform certain maintenance work correctly.

NOTE:

If you do not have the tools or experience required for a particular job, have a Yamaha dealer perform it for you.

EW000063

⚠ WARNING

Modifications not approved by Yamaha may cause loss of performance and render the vehicle unsafe for use. Consult a Yamaha dealer before attempting any changes.

PERIODIC MAINTENANCE AND MINOR REPAIR

EAU03685

Periodic maintenance and lubrication chart

NOTE:

- The annual checks must be performed every year, except if a kilometer-based maintenance is performed instead.
- From 50,000 km, repeat the maintenance intervals starting from 10,000 km.
- Items marked with an asterisk should be performed by a Yamaha dealer as they require special tools, data and technical skills.

NO.	ITEM	CHECK OR MAINTENANCE JOB	ODOMETER READING (× 1,000 km)					ANNUAL CHECK
			1	10	20	30	40	
1	* Fuel line	• Check fuel hoses for cracks or damage.		√	√	√	√	√
2	* Fuel filter	• Check condition.			√		√	
3	Spark plugs	• Check condition. • Clean and regap.		√		√		
		• Replace.			√		√	
4	* Valves	• Check valve clearance. • Adjust.		√	√	√	√	
5	Air filter element	• Clean.		√		√		
		• Replace.			√		√	
6	Clutch	• Check operation. • Adjust.	√	√	√	√	√	
7	* Front brake	• Check operation, fluid level and vehicle for fluid leakage. (See NOTE on page 6-4.)	√	√	√	√	√	√
		• Replace brake pads.	Whenever worn to the limit					
8	* Rear brake	• Check operation, fluid level and vehicle for fluid leakage. (See NOTE on page 6-4.)	√	√	√	√	√	√
		• Replace brake pads.	Whenever worn to the limit					
9	* Brake hose	• Check for cracks or damage.		√	√	√	√	√
		• Replace. (See NOTE on page 6-4.)	Every 4 years					

PERIODIC MAINTENANCE AND MINOR REPAIR

NO.	ITEM	CHECK OR MAINTENANCE JOB	ODOMETER READING ($\times 1,000$ km)					ANNUAL CHECK
			1	10	20	30	40	
10	* Wheels	<ul style="list-style-type: none"> • Check runout, spoke tightness and for damage. • Tighten spokes if necessary. 		√	√	√	√	
11	* Tires	<ul style="list-style-type: none"> • Check tread depth and for damage. • Replace if necessary. • Check air pressure. • Correct if necessary. 		√	√	√	√	
12	* Wheel bearings	<ul style="list-style-type: none"> • Check bearing for looseness or damage. 		√	√	√	√	
13	* Steering bearings	<ul style="list-style-type: none"> • Check bearing play and steering for roughness. 	√	√	√	√	√	
		<ul style="list-style-type: none"> • Lubricate with lithium-soap-based grease. 	Every 20,000 km					
14	* Chassis fasteners	<ul style="list-style-type: none"> • Make sure that all nuts, bolts and screws are properly tightened. 		√	√	√	√	√
15	Sidestand	<ul style="list-style-type: none"> • Check operation. • Lubricate. 		√	√	√	√	√
16	* Sidestand switch	<ul style="list-style-type: none"> • Check operation. 	√	√	√	√	√	√
17	* Front fork	<ul style="list-style-type: none"> • Check operation and for oil leakage. 		√	√	√	√	
18	* Rear shock absorber assembly	<ul style="list-style-type: none"> • Check operation and shock absorber for oil leakage. 		√	√	√	√	
		<ul style="list-style-type: none"> • Lubricate the pivoting points with molybdenum disulfide grease. 			√		√	
19	* Carburetors	<ul style="list-style-type: none"> • Check starter (choke) operation. • Adjust engine idling speed and synchronization. 	√	√	√	√	√	√
20	Engine oil	<ul style="list-style-type: none"> • Change. 	√	√	√	√	√	√
21	* Engine oil filter element	<ul style="list-style-type: none"> • Replace. 	√		√		√	
22	Final gear oil	<ul style="list-style-type: none"> • Check oil level and vehicle for oil leakage. 	√	√		√		
		<ul style="list-style-type: none"> • Change. 	√		√		√	
23	Moving parts and cables	<ul style="list-style-type: none"> • Lubricate. 		√	√	√	√	√
24	* Lights, signals and switches	<ul style="list-style-type: none"> • Check operation. • Adjust headlight beam. 	√	√	√	√	√	√

PERIODIC MAINTENANCE AND MINOR REPAIR

EAU03541

NOTE:

- The air filter needs more frequent service if you are riding in unusually wet or dusty areas.
 - Hydraulic brake service
 - Regularly check and, if necessary, correct the brake fluid level.
 - Every two years replace the internal components of the brake master cylinder and caliper, and change the brake fluid.
 - Replace the brake hoses every four years and if cracked or damaged.
-

PERIODIC MAINTENANCE AND MINOR REPAIR

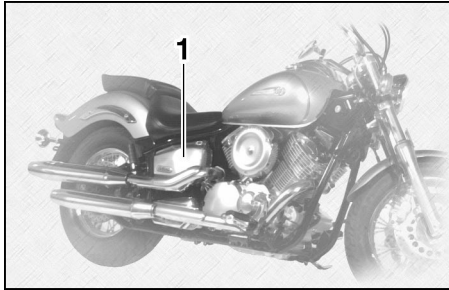

1. Panel A

EAU01777

Removing and installing the panel

The panel shown above needs to be removed to perform some of the maintenance jobs described in this chapter. Refer to this section each time the panel needs to be removed and installed.



1. Bolt

EAU00491

Panel A

To remove the panel

Remove the bolt, and then pull the panel off as shown.

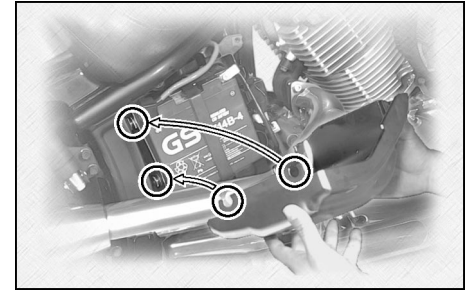

To install the panel

Place the panel in the original position, and then install the bolt.

PERIODIC MAINTENANCE AND MINOR REPAIR

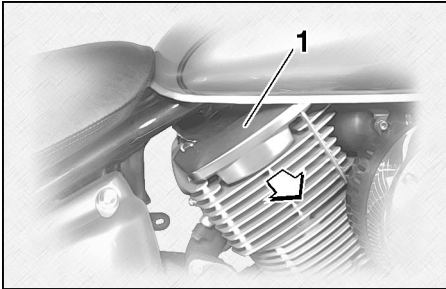

1. Spark plug cover

EAU01673

Checking the spark plugs

The spark plugs are important engine components, which are easy to check. Since heat and deposits will cause any spark plug to slowly erode, the spark plugs should be removed and checked in accordance with the periodic maintenance and lubrication chart. In addition, the condition of the spark plugs can reveal the condition of the engine.

To remove a spark plug

1. Remove the appropriate spark plug cover (rear right or front left) by pulling it off as shown.
2. Remove the spark plug cap.

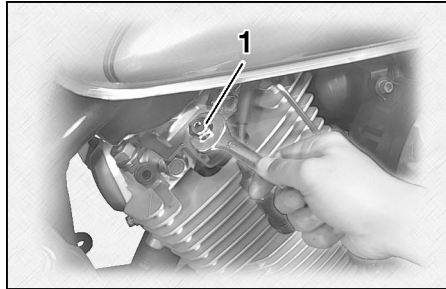

1. Spark plug wrench

3. Remove the spark plug as shown, with the spark plug wrench included in the owner's tool kit.

To check the spark plugs

1. Check that the porcelain insulator around the center electrode on each spark plug is a medium-to-light tan (the ideal color when the motorcycle is ridden normally).
2. Check that all spark plugs installed in the engine have the same color.

NOTE:

If any spark plug shows a distinctly different color, the engine could be defective. Do not attempt to diagnose such problems yourself. Instead, have a Yamaha dealer check the motorcycle.

3. Check each spark plug for electrode erosion and excessive carbon or other deposits, and replace it if necessary.

Specified spark plug:
BPR7ES (NGK) or
W22EPR-U (DENSO)

PERIODIC MAINTENANCE AND MINOR REPAIR

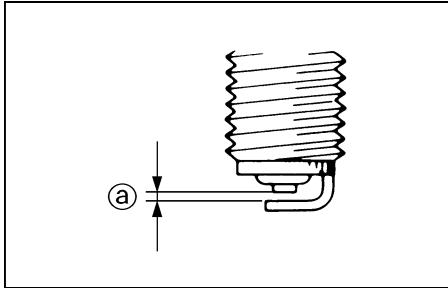

a. Spark plug gap

To install a spark plug

1. Measure the spark plug gap with a wire thickness gauge and, if necessary, adjust the gap to specification.

Spark plug gap:
0.7–0.8 mm

2. Clean the surface of the spark plug gasket and its mating surface, and then wipe off any grime from the spark plug threads.
3. Install the spark plug with the spark plug wrench, and then tighten it to the specified torque.

Tightening torque:
Spark plug:
20 Nm (2.0 m·kg)

NOTE: _____
If a torque wrench is not available when installing a spark plug, a good estimate of the correct torque is 1/4–1/2 turn past finger tight. However, the spark plug should be tightened to the specified torque as soon as possible.

4. Install the spark plug cap.
5. Place the spark plug cover in the original position.

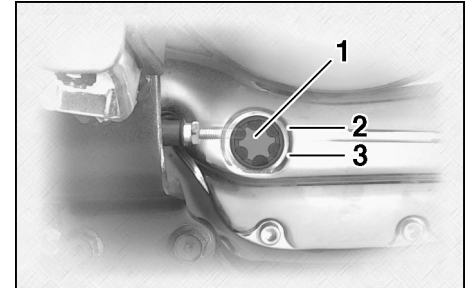

1. Engine oil level check window
2. Maximum level mark
3. Minimum level mark

EAU01712

Engine oil and oil filter element

The engine oil level should be checked before each ride. In addition, the oil must be changed and the oil filter element replaced at the intervals specified in the periodic maintenance and lubrication chart.

To check the engine oil level

1. Place the motorcycle on a level surface and hold it in an upright position.

PERIODIC MAINTENANCE AND MINOR REPAIR

NOTE:

Make sure that the motorcycle is positioned straight up when checking the oil level. A slight tilt to the side can result in a false reading.

2. Start the engine, warm it up for several minutes, and then turn it off.
3. Wait a few minutes until the oil settles, and then check the oil level through the check window located at the bottom-left side of the crankcase.

NOTE:

The engine oil should be between the minimum and maximum level marks.

4. If the engine oil is below the minimum level mark, add sufficient oil of the recommended type to raise it to the correct level.

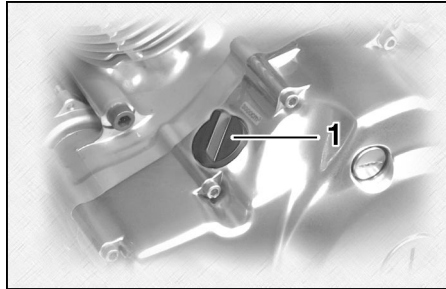

1. Engine oil filler cap

To change the engine oil without oil filter element replacement

1. Start the engine, warm it up for several minutes, and then turn it off.
2. Place an oil pan under the engine to collect the used oil.
3. Remove the engine oil filler cap and drain bolt to drain the oil from the crankcase.

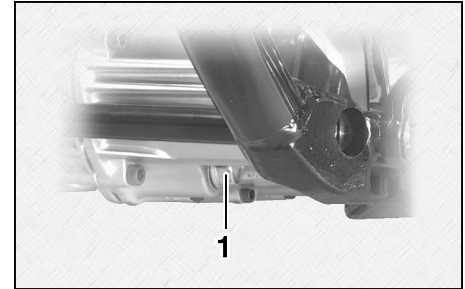

1. Engine oil drain bolt

4. Install the engine oil drain bolt, and then tighten it to the specified torque.

Tightening torque:
Engine oil drain bolt:
43 Nm (4.3 m·kg)

5. Add the specified amount of the recommended engine oil, and then install and tighten the oil filler cap.

PERIODIC MAINTENANCE AND MINOR REPAIR

Recommended engine oil:

See page 8-1.

Oil quantity:

Without oil filter element
replacement:

3.0 L

With oil filter element
replacement:

3.1 L

Total amount (dry engine):

3.6 L

EC000072

CAUTION:

- In order to prevent clutch slip-page (since the engine oil also lubricates the clutch), do not mix any chemical additives with the oil or use oils of a higher grade than “CD”. In addition, do not use oils labeled “ENERGY CONSERVING II” or higher.
- Make sure that no foreign material enters the crankcase.

6. Start the engine, and then let it idle for several minutes while checking it for oil leakage. If oil is leaking, immediately turn the engine off and check for the cause.

NOTE:

After the engine is started, the engine oil level warning light should go off if the oil level is sufficient.

EC000067

CAUTION:

If the oil level warning light flickers or remains on, immediately turn the engine off and have a Yamaha dealer check the vehicle.

7. Turn the engine off, and then check the oil level and correct it if necessary.

NOTE:

Have a Yamaha dealer replace the oil filter element when necessary.

EAU02943

Final gear oil

The final gear case must be checked for oil leakage before each ride. If any leakage is found, have a Yamaha dealer check and repair the motorcycle. In addition, the final gear oil level must be checked and the oil changed as follows at the intervals specified in the periodic maintenance and lubrication chart.

EW000066

WARNING

- Make sure that no foreign material enters the final gear case.
- Make sure that no oil gets on the tire or wheel.

PERIODIC MAINTENANCE AND MINOR REPAIR

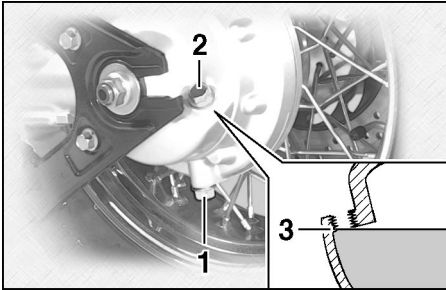

1. Final gear oil drain bolt
2. Final gear oil filler bolt
3. Correct oil level

To check the final gear oil level

1. Place the motorcycle on a level surface and hold it in an upright position.

NOTE:

- The final gear oil level must be checked on a cold engine.
- Make sure that the motorcycle is positioned straight up when checking the oil level. A slight tilt to the side can result in a false reading.

2. Remove the oil filler bolt, and then check the oil level in the final gear case.

NOTE:

The oil level should be at the brim of the filler hole.

3. If the oil is below the brim of the filler hole, add sufficient oil of the recommended type to raise it to the correct level.

To change the final gear oil

1. Place an oil pan under the final gear case to collect the used oil.
2. Remove the oil filler bolt and drain bolt to drain the oil from the final gear case.
3. Install the final gear oil drain bolt, and then tighten it to the specified torque.

Tightening torque:

Final gear oil drain bolt:
23 Nm (2.3 m·kg)

4. Add the recommended final gear oil to the brim of the filler hole.

Recommended final gear oil:

Hypoid gear oil SAE 80 (API GL4)
or multigrade hypoid gear oil SAE
80W-90

Oil quantity:
0.2 L

NOTE:

GL4 is a quality rating. Hypoid gear oils rated GL5 or GL6 may also be used.

5. Install and tighten the filler bolt to the specified torque.

Tightening torque:

Final gear oil filler bolt:
23 Nm (2.3 m·kg)

6. Check the final gear case for oil leakage. If oil is leaking, check for the cause.

PERIODIC MAINTENANCE AND MINOR REPAIR

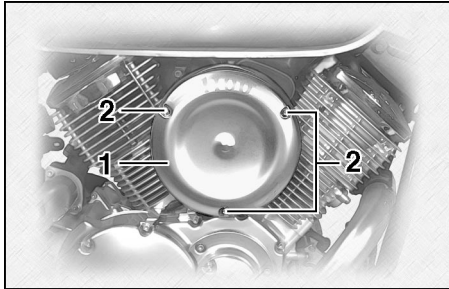

1. Air filter case cover
2. Screw (× 3)

EAU03195

Cleaning the air filter element

The air filter element should be cleaned as follows at the intervals specified in the periodic maintenance and lubrication chart. Clean the air filter element more frequently if you are riding in unusually wet or dusty areas.

1. Remove the air filter case cover by removing the screws.
2. Pull the air filter element out.



3. Lightly tap the air filter element to remove most of the dust and dirt, and then blow the remaining dirt out with compressed air as shown. If the air filter element is damaged, replace it.

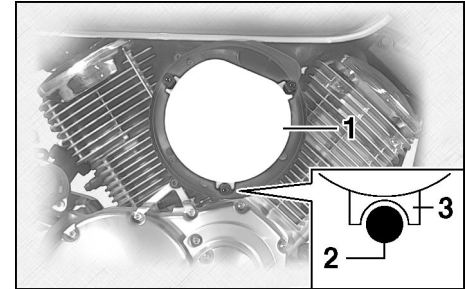

1. Air filter element
2. Projection
3. Tab

4. Insert the air filter element into the air filter case as shown.

EC000082

CAUTION:

- Make sure that the air filter element is properly seated in the air filter case.
- The engine should never be operated without the air filter element installed, otherwise the piston(s) and/or cylinder(s) may become excessively worn.

5. Install the air filter case cover by installing the screws.

PERIODIC MAINTENANCE AND MINOR REPAIR

Adjusting the carburetors

EAU00630

The carburetors are important parts of the engine and require very sophisticated adjustment. Therefore, most carburetor adjustments should be left to a Yamaha dealer, who has the necessary professional knowledge and experience. The adjustment described in the following section, however, may be serviced by the owner as part of routine maintenance.

EC000095

CAUTION:

The carburetors have been set and extensively tested at the Yamaha factory. Changing these settings without sufficient technical knowledge may result in poor performance of or damage to the engine.

Adjusting the engine idling speed

EAU01168

The engine idling speed must be checked and, if necessary, adjusted as follows at the intervals specified in the periodic maintenance and lubrication chart.

NOTE:

A diagnostic tachometer is needed to make this adjustment.

1. Attach the tachometer to the spark plug lead.
2. Start the engine and warm it up for several minutes at 1,000–2,000 r/min while occasionally revving it to 4,000–5,000 r/min.

NOTE:

The engine is warm when it quickly responds to the throttle.

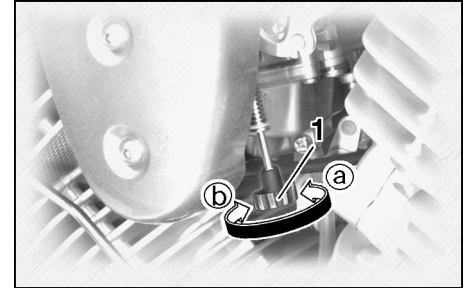

1. Throttle stop screw

3. Check the engine idling speed and, if necessary, adjust it to specification by turning the throttle stop screw. To increase the engine idling speed, turn the screw in direction Ⓐ. To decrease the engine idling speed, turn the screw in direction Ⓑ.

Engine idling speed:
950–1,050 r/min

NOTE:

If the specified idling speed cannot be obtained as described above, have a Yamaha dealer make the adjustment.

PERIODIC MAINTENANCE AND MINOR REPAIR

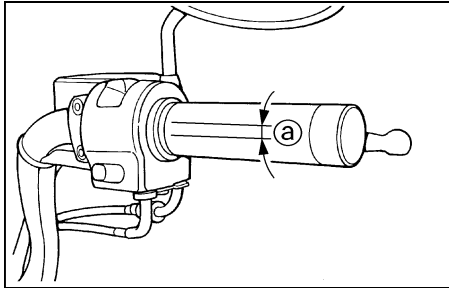

a. Throttle cable free play

EAU00635

Adjusting the throttle cable free play

The throttle cable free play should measure 4–6 mm at the throttle grip. Periodically check the throttle cable free play and, if necessary, have a Yamaha dealer adjust it.

EAU00637

Adjusting the valve clearance

The valve clearance changes with use, resulting in improper air-fuel mixture and/or engine noise. To prevent this from occurring, the valve clearance must be adjusted by a Yamaha dealer at the intervals specified in the periodic maintenance and lubrication chart.

EAU01543*

Tires

To ensure maximum performance, long service and safe operation, note the following:

Tire air pressure

Always check and adjust the tire pressure before operating the motorcycle.

EW000082

WARNING

- The tire air pressure must be checked and adjusted on cold tires (i.e., when the temperature of the tires equals the ambient temperature).
- The tire air pressure must be adjusted in accordance with the riding speed and with the total weight of rider, passenger, cargo, and accessories approved for this model.

PERIODIC MAINTENANCE AND MINOR REPAIR

Tire air pressure (measured on cold tires)		
Load*	Front	Rear
Up to 90 kg	225 kPa 2.25 kgf/cm ² 2.25 bar	225 kPa 2.25 kgf/cm ² 2.25 bar
90 kg–maximum	225 kPa 2.25 kgf/cm ² 2.25 bar	250 kPa 2.50 kgf/cm ² 2.50 bar

Maximum load*	200 kg
---------------	--------

* Total weight of rider, passenger, cargo and accessories

EW000083

⚠ WARNING

Proper loading of your motorcycle is important for several characteristics of your motorcycle, such as handling, braking, performance and safety. Do not carry loosely packed items that can shift. Securely pack your heaviest items close to the center of the motorcycle, and distribute the weight evenly from side to side. Properly adjust the suspension for your load, and check the condition and pressure of your tires. **NEVER OVERLOAD YOUR MOTORCYCLE.**

Make sure that the total weight of the cargo, rider, passenger, and accessories (cowling, saddlebags, etc. if approved for this model) does not exceed the maximum load of the motorcycle. Operation of an overloaded motorcycle could cause tire damage, an accident, or even injury.

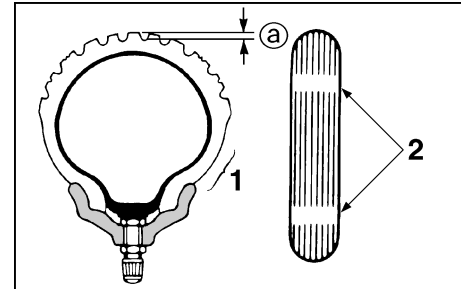

1. Tire sidewall
2. Tire wear indicator
- a. Tire tread depth

Tire inspection

Always check the tires before operating the motorcycle. If a tire tread shows crosswise lines (minimum tread depth), if the tire has a nail or glass fragments in it, or if the side wall is cracked, contact a Yamaha dealer immediately and have the tire replaced.

PERIODIC MAINTENANCE AND MINOR REPAIR

EAU00680

EAU00685

FRONT

Manufacturer	Size	Model
DUNLOP	130/90-16 67S	D404F

REAR

Manufacturer	Size	Model
DUNLOP	170/80-15 M/C 77S	D404G

Minimum tire tread depth (front and rear)	1.0 mm
--	--------

WARNING

- **It is dangerous to ride with a worn-out tire. When a tire tread begins to show crosswise lines, have a Yamaha dealer replace the tire immediately.**
- **The replacement of all wheel- and brake-related parts, including the tires, should be left to a Yamaha dealer, who has the necessary professional knowledge and experience.**
- **It is not recommended to patch a punctured tube. If unavoidable, however, patch the tube very carefully and replace it as soon as possible with a high-quality product.**

Spoke wheels

To maximize the performance, durability, and safe operation of your motorcycle, note the following points regarding the specified wheels.

- The wheel rims should be checked for cracks, bends or warpage, and the spokes for looseness or damage before each ride. If any damage is found, have a Yamaha dealer replace the wheel. Do not attempt even the smallest repair to the wheel. A deformed or cracked wheel must be replaced.
- The wheel should be balanced whenever either the tire or wheel has been changed or replaced. An unbalanced wheel can result in poor performance, adverse handling characteristics, and a shortened tire life.
- Ride at moderate speeds after changing a tire since the tire surface must first be “broken in” for it to develop its optimal characteristics.

PERIODIC MAINTENANCE AND MINOR REPAIR

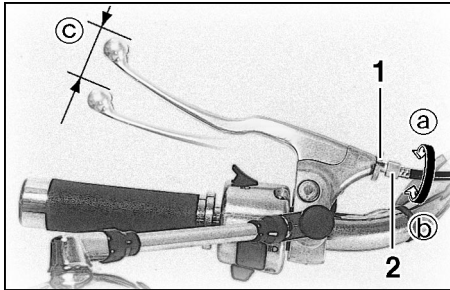

1. Locknut
2. Clutch lever free adjusting bolt
- c. Clutch lever free play

EAU00692

Adjusting the clutch lever free play

The clutch lever free play should measure 5–10 mm as shown. Periodically check the clutch lever free play and, if necessary, adjust it as follows.

1. Loosen the locknut at the clutch lever.
2. To increase the clutch lever free play, turn the adjusting bolt in direction (a). To decrease the clutch lever free play, turn the adjusting bolt in direction (b).
3. Tighten the locknut.

NOTE: _____
If the specified free play cannot be obtained as described above or if the clutch does not operate correctly, have a Yamaha dealer check the internal clutch mechanism.

PERIODIC MAINTENANCE AND MINOR REPAIR

EW000099

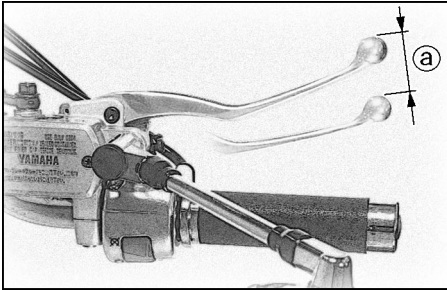

a. Brake lever free play

EAU00696

Adjusting the brake lever free play

The brake lever free play should measure 5–8 mm as shown. Periodically check the brake lever free play and, if necessary, adjust it as follows.

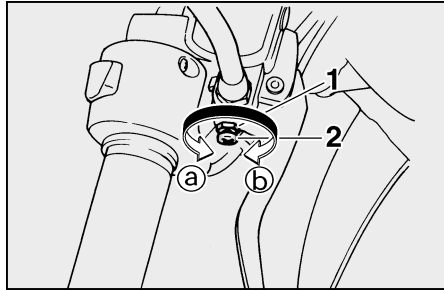

1. Locknut
2. Brake lever free play adjusting bolt

1. Loosen the locknut at the brake lever.
2. To increase the brake lever free play, turn the adjusting bolt in direction **a**. To decrease the brake lever free play, turn the adjusting bolt in direction **b**.
3. Tighten the locknut.

! WARNING

- After adjusting the brake lever free play, check the free play and make sure that the brake is working properly.
- A soft or spongy feeling in the brake lever can indicate the presence of air in the hydraulic system. If there is air in the hydraulic system, have a Yamaha dealer bleed the system before operating the motorcycle. Air in the hydraulic system will diminish the braking performance, which may result in loss of control and an accident.

EW000109

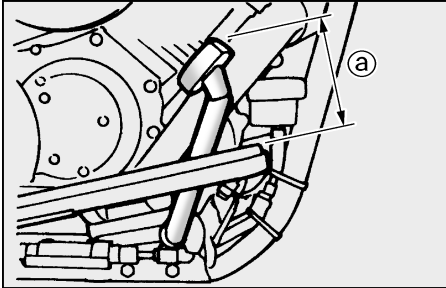

a. Distance between brake pedal and footrest

EAU01746

Adjusting the brake pedal position

The top of the brake pedal should be positioned approximately 98.5 mm above the top of the footrest as shown. Periodically check the brake pedal position and, if necessary, have a Yamaha dealer adjust it.

⚠ WARNING

A soft or spongy feeling in the brake pedal can indicate the presence of air in the hydraulic system. If there is air in the hydraulic system, have a Yamaha dealer bleed the system before operating the motorcycle. Air in the hydraulic system will diminish the braking performance, which may result in loss of control and an accident.

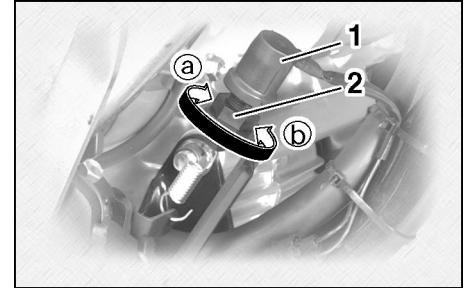

1. Brake light switch
2. Brake light switch adjusting nut

EAU00713

Adjusting the rear brake light switch

The rear brake light switch, which is activated by the brake pedal, is properly adjusted when the brake light comes on just before braking takes effect. If necessary, adjust the brake light switch as follows.

Turn the adjusting nut while holding the rear brake light switch in place. To make the brake light come on earlier, turn the adjusting nut in direction Ⓐ. To make the brake light come on later, turn the adjusting nut in direction Ⓑ.

PERIODIC MAINTENANCE AND MINOR REPAIR

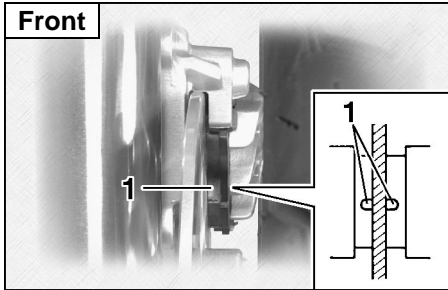

1. Brake pad wear indicator groove

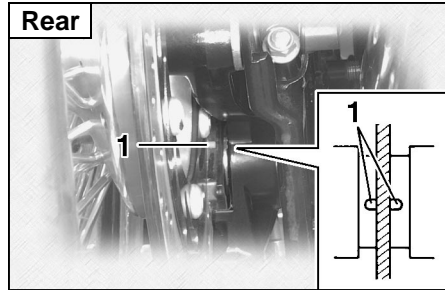

1. Brake pad wear indicator groove

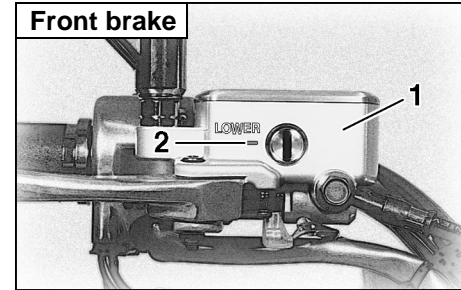

1. Front brake fluid reservoir
2. Minimum level mark

EAU01314

Checking the front and rear brake pads

The front and rear brake pads must be checked for wear at the intervals specified in the periodic maintenance and lubrication chart. Each brake pad is provided with a wear indicator groove, which allows you to check the brake pad wear without having to disassemble the brake. To check the brake pad wear, check the wear indicator grooves. If a brake pad has worn to the point that the wear indicator groove has almost disappeared, have a Yamaha dealer replace the brake pads as a set.

EAU03607*

Checking the brake fluid level

Insufficient brake fluid may allow air to enter the brake system, possibly causing it to become ineffective.

Before riding, check that the brake fluid is above the minimum level mark and replenish if necessary. A low brake fluid level may indicate worn brake pads and/or brake system leakage. If the brake level is low, be sure to check the brake pads for wear and the brake system for leakage.

PERIODIC MAINTENANCE AND MINOR REPAIR

EAU03238

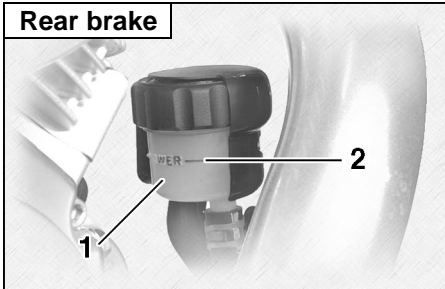

1. Rear brake fluid reservoir
2. Minimum level mark

Observe these precautions:

- When checking the fluid level, make sure that the top of the brake fluid reservoir is level.
- Use only the recommended quality brake fluid, otherwise the rubber seals may deteriorate, causing leakage and poor braking performance.

Recommended brake fluid: DOT 4

- Refill with the same type of brake fluid. Mixing fluids may result in a harmful chemical reaction and lead to poor braking performance.
- Be careful that water does not enter the brake fluid reservoir when refilling. Water will significantly lower the boiling point of the fluid and may result in vapor lock.
- Brake fluid may deteriorate painted surfaces or plastic parts. Always clean up spilled fluid immediately.
- As the brake pads wear, it is normal for the brake fluid level to gradually go down. However, if the brake fluid level goes down suddenly, have a Yamaha dealer check the cause.

Changing the brake fluid

Have a Yamaha dealer change the brake fluid at the intervals specified in the periodic maintenance and lubrication chart. In addition, have the oil seals of the brake master cylinder and caliper as well as the brake hose replaced at the intervals listed below or whenever they are damaged or leaking.

- Oil seals: Replace every two years.
- Brake hose: Replace every four years.

PERIODIC MAINTENANCE AND MINOR REPAIR

Checking and lubricating the cables

EAU02962

The operation of all control cables and the condition of the cables should be checked before each ride, and the cables and cable ends should be lubricated if necessary. If a cable is damaged or does not move smoothly, have a Yamaha dealer check or replace it.

Recommended lubricant:
Engine oil

EW000112

WARNING

Damage to the outer sheath may interfere with proper cable operation and will cause the inner cable to rust. Replace a damaged cable as soon as possible to prevent unsafe conditions.

Checking and lubricating the throttle grip and cable

EAU03764

The operation of the throttle grip and the condition of the throttle cable should be checked before each ride, and the cable should be lubricated or replaced if necessary.

NOTE: _____
Since the throttle grip must be removed to access the throttle cable end, the throttle grip and the cable should always be lubricated at the same time.

1. Remove the throttle grip by removing the screws.
2. Hold up the throttle cable and then apply several drops of oil to the cable, allowing it to trickle into the sheath.
3. Grease the inside of the throttle grip housing.

4. Grease the metal-to-metal contact surface of the throttle grip, and then install the grip by installing the screws.

Recommended lubricant:

Throttle cable:

Engine oil

Throttle grip housing and grip:

Lithium-soap-based grease
(all-purpose grease)

PERIODIC MAINTENANCE AND MINOR REPAIR

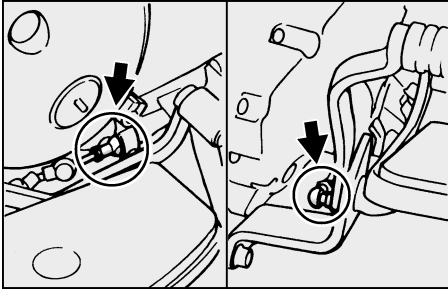

EAU03370

Checking and lubricating the brake and shift pedals

The operation of the brake and shift pedals should be checked before each ride, and the pedal pivots should be lubricated if necessary.

Recommended lubricant:
Lithium-soap-based grease
(all-purpose grease)

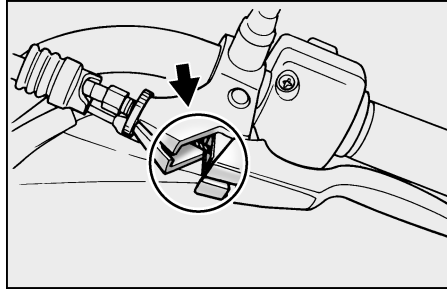

EAU03164

Checking and lubricating the brake and clutch levers

The operation of the brake and clutch levers should be checked before each ride, and the lever pivots should be lubricated if necessary.

Recommended lubricant:
Lithium-soap-based grease
(all-purpose grease)

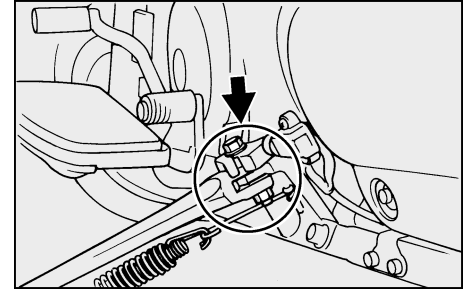

EAU03165

Checking and lubricating the sidestand

The operation of the sidestand should be checked before each ride, and the sidestand pivot and metal-to-metal contact surfaces should be lubricated if necessary.

EW000113

⚠ WARNING

If the sidestand does not move up and down smoothly, have a Yamaha dealer check or repair it.

Recommended lubricant:
Lithium-soap-based grease
(all-purpose grease)

PERIODIC MAINTENANCE AND MINOR REPAIR

Checking the front fork

The condition and operation of the front fork must be checked as follows at the intervals specified in the periodic maintenance and lubrication chart.

EAU02939

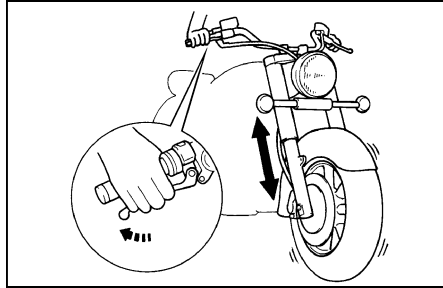

To check the condition

EW000115

⚠ WARNING

Securely support the motorcycle so that there is no danger of it falling over.

Check the inner tubes for scratches, damage and excessive oil leakage.

To check the operation

1. Place the motorcycle on a level surface and hold it in an upright position.
2. While applying the front brake, push down hard on the handlebars several times to check if the front fork compresses and rebounds smoothly.

EC000098

CAUTION:

If any damage is found or the front fork does not operate smoothly, have a Yamaha dealer check or repair it.

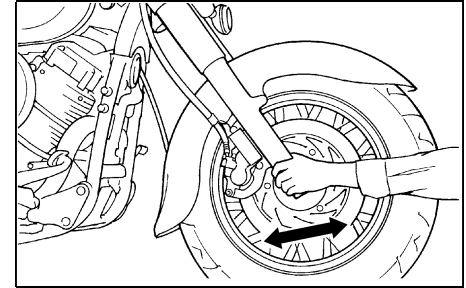

EAU00794

Checking the steering

Worn or loose steering bearings may cause danger. Therefore, the operation of the steering must be checked as follows at the intervals specified in the periodic maintenance and lubrication chart.

1. Place a stand under the engine to raise the front wheel off the ground.

EW000115

⚠ WARNING

Securely support the motorcycle so that there is no danger of it falling over.

PERIODIC MAINTENANCE AND MINOR REPAIR

2. Hold the lower ends of the front fork legs and try to move them forward and backward. If any free play can be felt, have a Yamaha dealer check or repair the steering.

EAU01144

Checking the wheel bearings

The front and rear wheel bearings must be checked at the intervals specified in the periodic maintenance and lubrication chart. If there is play in the wheel hub or if the wheel does not turn smoothly, have a Yamaha dealer check the wheel bearings.

PERIODIC MAINTENANCE AND MINOR REPAIR

Battery

EAU00800

This motorcycle is equipped with a sealed-type (MF) battery, which does not require any maintenance. There is no need to check the electrolyte or to add distilled water.

EC000101

CAUTION:

Never attempt to remove the battery cell seals, as this would permanently damage the battery.

EW000116

WARNING

- **Electrolyte is poisonous and dangerous since it contains sulfuric acid, which causes severe burns. Avoid any contact with skin, eyes or clothing and always shield your eyes when working near batteries. In case of contact, administer the following FIRST AID.**
 - **EXTERNAL:** Flush with plenty of water.
 - **INTERNAL:** Drink large quantities of water or milk and immediately call a physician.
 - **EYES:** Flush with water for 15 minutes and seek prompt medical attention.
- **Batteries produce explosive hydrogen gas. Therefore, keep sparks, flames, cigarettes, etc., away from the battery and provide sufficient ventilation when charging it in an enclosed space.**

- **KEEP THIS AND ALL BATTERIES OUT OF THE REACH OF CHILDREN.**
-

PERIODIC MAINTENANCE AND MINOR REPAIR

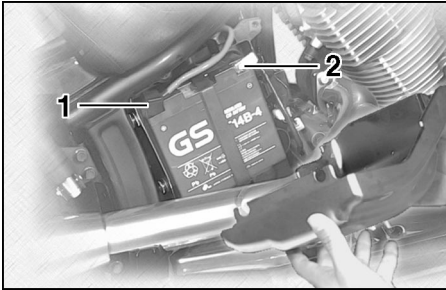

1. Positive battery terminal
2. Negative battery terminal

To charge the battery

Have a Yamaha dealer charge the battery as soon as possible if it seems to have discharged. Keep in mind that the battery tends to discharge more quickly if the motorcycle is equipped with optional electrical accessories.

To store the battery

1. If the motorcycle will not be used for more than one month, remove the battery, fully charge it, and then place it in a cool, dry place.

2. If the battery will be stored for more than two months, check it at least once a month and fully charge it if necessary.
3. Fully charge the battery before installation.
4. After installation, make sure that the battery leads are properly connected to the battery terminals.

EC000102

CAUTION:

- Always keep the battery charged. Storing a discharged battery can cause permanent battery damage.
- To charge a sealed-type (MF) battery, a special (constant-voltage) battery charger is required. Using a conventional battery charger will damage the battery. If you do not have access to a sealed-type (MF) battery charger, have a Yamaha dealer charge your battery.

PERIODIC MAINTENANCE AND MINOR REPAIR

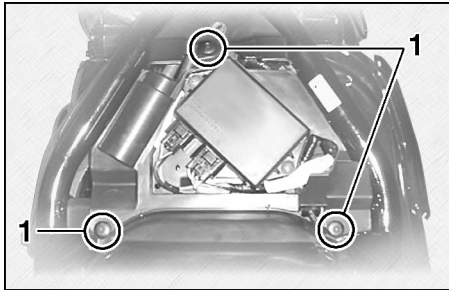

1. Quick fastener (× 3)

EAU01711

Replacing the fuses

The main fuse box is located under the rider seat. To access the main fuse box, proceed as follows.

1. Remove the rider seat. (See page 3-10 for rider seat removal and installation procedures.)
2. Remove each of the quick fasteners shown by pushing the center in with a screwdriver, then pulling the fastener out.

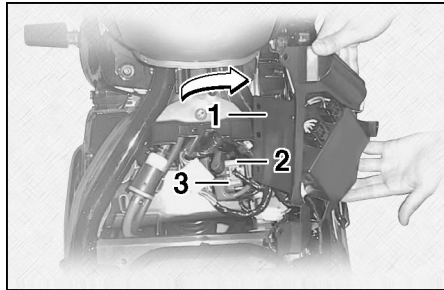

1. Ignitor unit panel
2. Spare main fuse
3. Main fuse

3. Pull the ignitor unit panel outward to the right.

NOTE:

To install a quick fastener, push its pin back so that it will protrude from the fastener head, then insert the fastener and push the protruding pin in until it is flush with the fastener head.

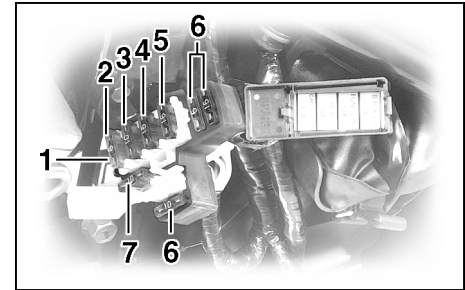

1. Fuse box
2. Odometer fuse
3. Ignition fuse
4. Headlight fuse
5. Carburetor heater fuse
6. Spare fuse (× 3)
7. Signaling system fuse

The fuse box, which contains the fuses for the individual circuits, is located inside the storage compartment. (See page 3-11 for storage compartment cover removal and installation procedures.)

PERIODIC MAINTENANCE AND MINOR REPAIR

If a fuse is blown, replace it as follows.

1. Turn the key to "OFF" and turn off the electrical circuit in question.
2. Remove the blown fuse, and then install a new fuse of the specified amperage.

Specified fuses:

Main fuse:	30 A
Odometer fuse:	5 A
Ignition fuse:	10 A
Headlight fuse:	15 A
Carburetor heater fuse:	15 A
Signaling system fuse:	10 A

EC000103

CAUTION:

Do not use a fuse of a higher amperage rating than recommended to avoid causing extensive damage to the electrical system and possibly a fire.

3. Turn the key to "ON" and turn on the electrical circuit in question to check if the device operates.

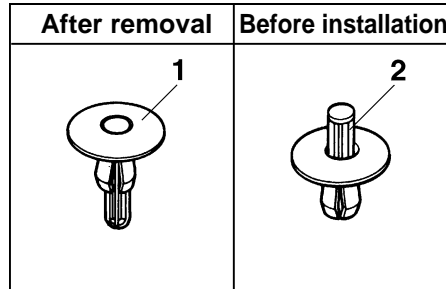

1. Quick fastener
2. Pin

4. If the fuse immediately blows again, have a Yamaha dealer check the electrical system.

PERIODIC MAINTENANCE AND MINOR REPAIR

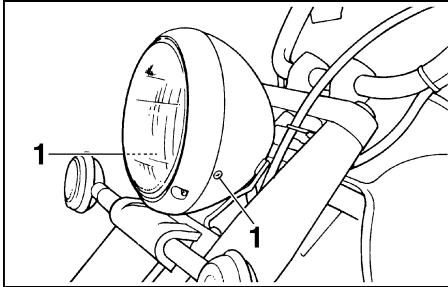

1. Screw (× 2)

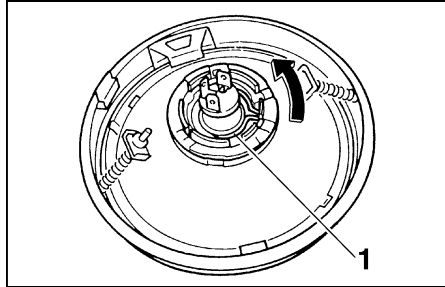

1. Headlight bulb holder

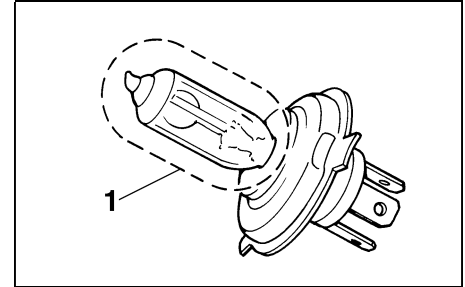

1. Do not touch this area.

EAU03003

Replacing the headlight bulb

This motorcycle is equipped with a quartz bulb headlight. If the headlight bulb burns out, replace it as follows.

1. Remove the headlight unit by removing the screws.
2. Disconnect the headlight coupler, and then remove the headlight unit and bulb cover.

3. Remove the headlight bulb holder by turning it counterclockwise, and then remove the defective bulb.

EW000119

WARNING

Headlight bulbs get very hot. Therefore, keep flammable products away from a lit headlight bulb, and do not touch the bulb until it has cooled down.

4. Place a new bulb into position, and then secure it with the bulb holder.

PERIODIC MAINTENANCE AND MINOR REPAIR

EC000105

CAUTION:

Do not touch the glass part of the headlight bulb to keep it free from oil, otherwise the transparency of the glass, the luminosity of the bulb, and the bulb life will be adversely affected. Thoroughly clean off any dirt and fingerprints on the headlight bulb using a cloth moistened with alcohol or thinner.

5. Install the bulb cover, and then connect the coupler.
6. Install the headlight unit by installing the screws.
7. Have a Yamaha dealer adjust the headlight beam if necessary.

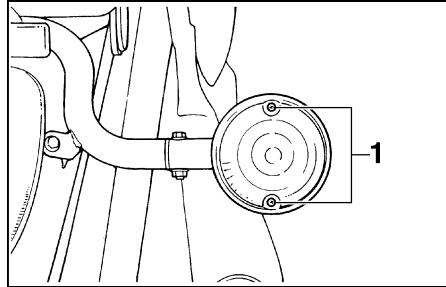

1. Screw (× 2)

Replacing a turn signal light bulb or the tail/brake light bulb

1. Remove the lens by removing the screws.
2. Remove the defective bulb by pushing it in and turning it counter-clockwise.

EAU00855

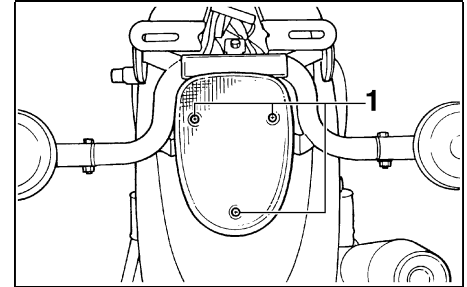

1. Screw (× 3)

3. Insert a new bulb into the socket, push it in, and then turn it clockwise until it stops.
4. Install the lens by installing the screws.

EC000108

CAUTION:

Do not overtighten the screws, otherwise the lens may break.

PERIODIC MAINTENANCE AND MINOR REPAIR

EAU01008

Troubleshooting

Although Yamaha motorcycles receive a thorough inspection before shipment from the factory, trouble may occur during operation. Any problem in the fuel, compression, or ignition systems, for example, can cause poor starting and loss of power.

The following troubleshooting chart represents a quick and easy procedure for checking these vital systems yourself. However, should your motorcycle require any repair, take it to a Yamaha dealer, whose skilled technicians have the necessary tools, experience, and know-how to service the motorcycle properly.

Use only genuine Yamaha replacement parts. Imitation parts may look like Yamaha parts, but they are often inferior, have a shorter service life and can lead to expensive repair bills.

PERIODIC MAINTENANCE AND MINOR REPAIR

EAU01297

Troubleshooting chart

EW000125



WARNING

Keep away from open flames and do not smoke while checking or working on the fuel system.

1. Fuel

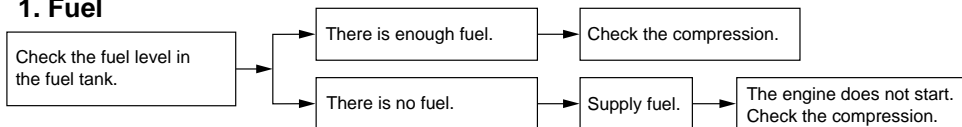

2. Compression

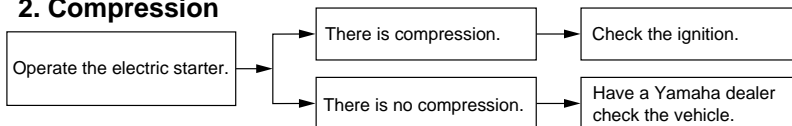

3. Ignition

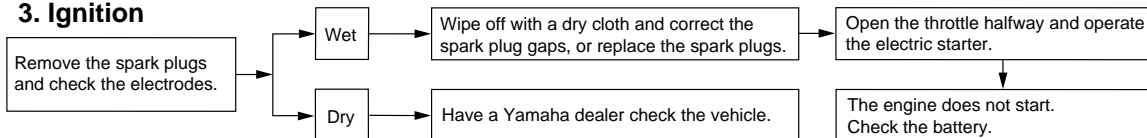

4. Battery

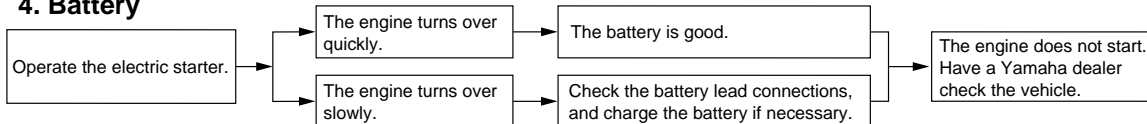

MOTORCYCLE CARE AND STORAGE

Care	7-1
Storage	7-4

Care

While the open design of a motorcycle reveals the attractiveness of the technology, it also makes it more vulnerable. Rust and corrosion can develop even if high-quality components are used. A rusty exhaust pipe may go unnoticed on a car, however, it detracts from the overall appearance of a motorcycle. Frequent and proper care does not only comply with the terms of the warranty, but it will also keep your motorcycle looking good, extend its life and optimize its performance.

Before cleaning

1. Cover the muffler outlets with plastic bags after the engine has cooled down.
2. Make sure that all caps and covers as well as all electrical couplers and connectors, including the spark plug caps, are tightly installed.
3. Remove extremely stubborn dirt, like oil burnt onto the crankcase, with a degreasing agent and a brush, but never apply such products onto seals, gaskets and wheel axles. Always rinse the dirt and degreaser off with water.

Cleaning

ECA00010

CAUTION:

- **Avoid using strong acidic wheel cleaners, especially on spoked wheels. If such products are used on hard-to-remove dirt, do not leave the cleaner on the affected area any longer than instructed. Also, thoroughly rinse the area off with water, immediately dry it, and then apply a corrosion protection spray.**
- **Improper cleaning can damage windshields, cowlings, panels and other plastic parts. Use only a soft, clean cloth or sponge with mild detergent and water to clean plastic.**

MOTORCYCLE CARE AND STORAGE

- Do not use any harsh chemical products on plastic parts. Be sure to avoid using cloths or sponges which have been in contact with strong or abrasive cleaning products, solvent or thinner, fuel (gasoline), rust removers or inhibitors, brake fluid, antifreeze or electrolyte.
- Do not use high-pressure washers or steam-jet cleaners since they cause water seepage and deterioration in the following areas: seals (of wheel and swing-arm bearings, fork and brakes), electric components (couplers, connectors, instruments, switches and lights), breather hoses and vents.
- For motorcycles equipped with a windshield: Do not use strong cleaners or hard sponges as they will cause dulling or scratching. Some cleaning compounds for plastic may leave scratches on the windshield. Test the product on a small hidden part of the windshield to make sure that it does not leave any marks. If the windshield is scratched, use a quality plastic polishing compound after washing.

After normal use

Remove dirt with warm water, a mild detergent, and a soft, clean sponge, and then rinse thoroughly with clean water. Use a toothbrush or bottlebrush for hard-to-reach areas. Stubborn dirt and insects will come off more easily if the area is covered with a wet cloth for a few minutes before cleaning.

After riding in the rain, near the sea or on salt-sprayed roads

Since sea salt or salt sprayed on roads during winter are extremely corrosive in combination with water, carry out the following steps after each ride in the rain, near the sea or on salt-sprayed roads.

NOTE: _____
Salt sprayed on roads in the winter may remain well into spring.

1. Clean the motorcycle with cold water and a mild detergent, after the engine has cooled down.

ECA00012

CAUTION: _____
Do not use warm water since it increases the corrosive action of the salt.

2. After drying the motorcycle, apply a corrosion protection spray on all metal, including chrome- and nickel-plated, surfaces to prevent corrosion.

MOTORCYCLE CARE AND STORAGE

After cleaning

1. Dry the motorcycle with a chamois or an absorbing cloth.
2. Use a chrome polish to shine chrome, aluminum and stainless-steel parts, including the exhaust system. (Even the thermally induced discoloring of stainless-steel exhaust systems can be removed through polishing.)
3. To prevent corrosion, it is recommended to apply a corrosion protection spray on all metal, including chrome- and nickel-plated, surfaces.
4. Use spray oil as a universal cleaner to remove any remaining dirt.
5. Touch up minor paint damage caused by stones, etc.
6. Wax all painted surfaces.
7. Let the motorcycle dry completely before storing or covering it.

EWA00031

WARNING

- Make sure that there is no oil or wax on the brakes or tires.
- If necessary, clean the brake discs and brake linings with a regular brake disc cleaner or acetone, and wash the tires with warm water and a mild detergent. Before riding at higher speeds, test the motorcycle's braking performance and cornering behavior.

ECA00013

CAUTION:

- Apply spray oil and wax sparingly and make sure to wipe off any excess.
- Never apply oil or wax to any rubber and plastic parts, but treat them with a suitable care product.
- Avoid using abrasive polishing compounds as they will wear away the paint.

NOTE:

Consult a Yamaha dealer for advice on what products to use.

MOTORCYCLE CARE AND STORAGE

Storage

Short-term

Always store your motorcycle in a cool, dry place and, if necessary, protect it against dust with a porous cover.

ECA00014

CAUTION:

- **Storing the motorcycle in a poorly ventilated room or covering it with a tarp, while it is still wet, will allow water and humidity to seep in and cause rust.**
- **To prevent corrosion, avoid damp cellars, stables (because of the presence of ammonia) and areas where strong chemicals are stored.**

Long-term

Before storing your motorcycle for several months:

1. Follow all the instructions in the “Care” section of this chapter.
2. For motorcycles equipped with a fuel cock that has an “OFF” position: Turn the fuel cock lever to “OFF”.
3. Drain the carburetor float chambers by loosening the drain bolts; this will prevent fuel deposits from building up. Pour the drained fuel into the fuel tank.
4. Fill up the fuel tank and add fuel stabilizer (if available) to prevent the fuel tank from rusting and the fuel from deteriorating.
5. Perform the following steps to protect the cylinders, piston rings, etc. from corrosion.

- a. Remove the spark plug caps and spark plugs.
- b. Pour a teaspoonful of engine oil into each spark plug bore.
- c. Install the spark plug caps onto the spark plugs, and then place the spark plugs on the cylinder head so that the electrodes are grounded. (This will limit sparking during the next step.)
- d. Turn the engine over several times with the starter. (This will coat the cylinder walls with oil.)
- e. Remove the spark plug caps from the spark plugs, and then install the spark plugs and the spark plug caps.

EWA00003

WARNING

To prevent damage or injury from sparking, make sure to ground the spark plug electrodes while turning the engine over.

MOTORCYCLE CARE AND STORAGE

6. Lubricate all control cables and the pivoting points of all levers and pedals as well as of the sidestand/centerstand.
7. Check and, if necessary, correct the tire air pressure, and then lift the motorcycle so that both of its wheels are off the ground. Alternatively, turn the wheels a little every month in order to prevent the tires from becoming degraded in one spot.
8. Cover the muffler outlets with plastic bags to prevent moisture from entering them.
9. Remove the battery and fully charge it. Store it in a cool, dry place and charge it once a month. Do not store the battery in an excessively cold or warm place (less than 0 °C or more than 30 °C). For more information on storing the battery, see page 6-26.

NOTE: _____
Make any necessary repairs before storing the motorcycle.

Specifications 8-1
Conversion table 8-5

Specifications

Model	XVS1100A
Dimensions	
Overall length	2,465 mm
Overall width	945 mm
Overall height	1,095 mm
Seat height	710 mm
Wheelbase	1,645 mm
Ground clearance	145 mm
Minimum turning radius	3,300 mm
Basic weight (with oil and full fuel tank)	288 kg
Engine	
Engine type	Air-cooled 4-stroke, SOHC
Cylinder arrangement	V type 2-cylinder
Displacement	1,063 cm ³
Bore × stroke	95.0 × 75.0 mm
Compression ratio	8.3:1
Starting system	Electric starter
Lubrication system	Wet sump

Engine oil

Type

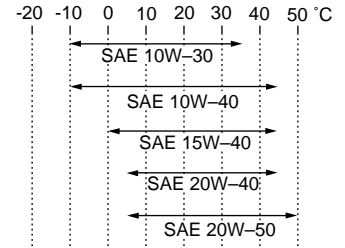

Recommended engine oil classification

API Service SE, SF, SG or higher

CAUTION:

Be sure to use motor oils that do not contain anti-friction modifiers. Passenger car motor oils (often labeled "ENERGY CONSERVING II") contain anti-friction additives which will cause clutch and/or starter clutch slippage, resulting in reduced component life and poor engine performance.

Quantity

Without oil filter element replacement	3.0 L
With oil filter element replacement	3.1 L
Total amount (dry engine)	3.6 L

Final gear oil

Type Hypoid gear oil SAE 80 (API GL4)
or multigrade hypoid gear oil SAE
80W-90

Quantity 0.2 L

Air filter

Dry type element

Fuel

Type Regular unleaded gasoline

Fuel tank capacity 17 L

Fuel reserve amount 4.5 L

Carburetor

Manufacturer MIKUNI

Model × quantity BSR37 × 2

Spark plug

Manufacturer/model NGK / BPR7ES or
DENSO / W22EPR-U

Gap 0.7–0.8 mm

Clutch type

Wet, multiple-disc

Transmission

Primary reduction system Spur gear

Primary reduction ratio 1.660

Secondary reduction system Shaft drive

Secondary reduction ratio 2.875

Transmission type Constant mesh 5-speed

Operation Left foot

Gear ratio

1st 2.353

2nd 1.667

3rd 1.286

4th 1.032

5th 0.853

Chassis

Frame type Double cradle

Caster angle 33°

Trail 132 mm

Tires

Front

Type Tube tire

Size 130/90-16 67S

Manufacturer/
model Dunlop / D404F

Rear

Type Tube tire

Size 170/80-15 M/C 77S

Manufacturer/
model Dunlop / D404G

SPECIFICATIONS

Maximum load*	200 kg
Tire air pressure (measured on cold tires)	
Up to 90 kg*	
Front	225 kPa (2.25 kgf/cm ² , 2.25 bar)
Rear	225 kPa (2.25 kgf/cm ² , 2.25 bar)
90 kg–maximum*	
Front	225 kPa (2.25 kgf/cm ² , 2.25 bar)
Rear	250 kPa (2.50 kgf/cm ² , 2.50 bar)

* Total weight of rider, passenger, cargo and accessories

Wheels

Front

Type	Spoke wheel
Size	16 × MT 3.00

Rear

Type	Spoke wheel
Size	15M/C × MT 4.50

Brakes

Front

Type	Dual disc brake
Operation	Right hand
Fluid	DOT 4

Rear

Type	Single disc brake
Operation	Right foot
Fluid	DOT 4

Suspension

Front	Telescopic fork
Rear	Swingarm (link suspension)

Spring/shock absorber

Front	Coil spring / oil damper
Rear	Coil spring / gas-oil damper, spring preload adjustable

Wheel travel

Front	140 mm
Rear	113 mm

Electrical system

Ignition system	Transistorized coil ignition (digital)
-----------------	--

Charging system

Type	A.C. magneto
Standard output	14 V, 350 W@ 5,000 r/min

Battery

Model	GT14B-4
Voltage, capacity	12 V, 12 Ah

Headlight type

Quartz bulb (halogen)

Bulb voltage, wattage × quantity

Headlight	12 V, 60/55 W × 1
Tail/brake light	12 V, 5/21 W × 1
Turn signal light	12 V, 21 W × 4
Meter lighting	14 V, 1.4 W × 2
Oil level warning light	12 V, 1.7 W × 1
Neutral indicator light	12 V, 1.7 W × 1
Turn signal indicator light	12 V, 1.7 W × 1
Engine trouble warning light	12 V, 1.7 W × 1
High beam indicator light	12 V, 1.7 W × 1

Fuses

Main fuse	30 A
Signaling system fuse	10 A
Odometer fuse	5 A
Ignition fuse	10 A
Headlight fuse	15 A
Carburetor heater fuse	15 A

SPECIFICATIONS

EAU01064

Conversion table

All specification data in this manual are listed in SI and METRIC UNITS.

Use this table to convert METRIC unit data to IMPERIAL unit data.

Example

METRIC		MULTIPLIER	=	IMPERIAL
** mm	×	0.03937	=	** in
2 mm	×	0.03937	=	0.08 in

Conversion table

METRIC TO IMPERIAL			
	Metric unit	Multiplier	Imperial unit
Torque	m·kg	7.233	ft·lb
	m·kg	86.794	in·lb
	cm·kg	0.0723	ft·lb
	cm·kg	0.8679	in·lb
Weight	kg	2.205	lb
	g	0.03527	oz
Speed	km/h	0.6214	mi/h
Distance	km	0.6214	mi
	m	3.281	ft
	m	1.094	yd
	cm	0.3937	in
	mm	0.03937	in
Volume, Capacity	cc (cm ³)	0.03527	oz (IMP liq.)
	cc (cm ³)	0.06102	cu-in
	L (liter)	0.8799	qt (IMP liq.)
	L (liter)	0.2199	gal (IMP liq.)
Miscellaneous	kg/mm	55.997	lb/in
	kg/cm ²	14.2234	psi (lb/in ²)
	Centigrade (°C)	9/5 + 32	Fahrenheit (°F)

Identification numbers	9-1
Key identification number	9-1
Vehicle identification number	9-1
Model label	9-2
Motorcycle noise regulation (for Australia)	9-2

Identification numbers

EAU02944

Record the key identification number, vehicle identification number and model label information in the spaces provided below for assistance when ordering spare parts from a Yamaha dealer or for reference in case the vehicle is stolen.

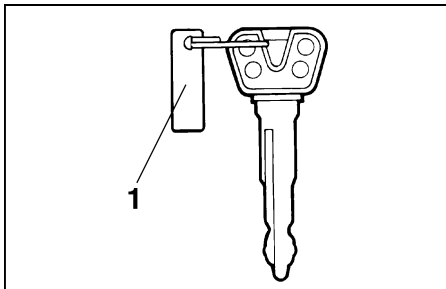

1. Key identification number

1. KEY IDENTIFICATION NUMBER:

2. VEHICLE IDENTIFICATION NUMBER:

3. MODEL LABEL INFORMATION:

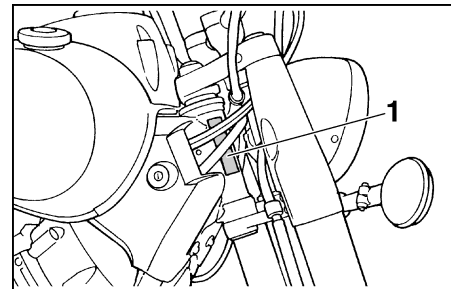

1. Vehicle identification number

EAU01041

Key identification number

The key identification number is stamped into the key tag. Record this number in the space provided and use it for reference when ordering a new key.

EAU01043

Vehicle identification number

The vehicle identification number is stamped into the steering head pipe. Record this number in the space provided.

NOTE: _____

The vehicle identification number is used to identify your motorcycle and may be used to register your motorcycle with the licensing authority in your area.

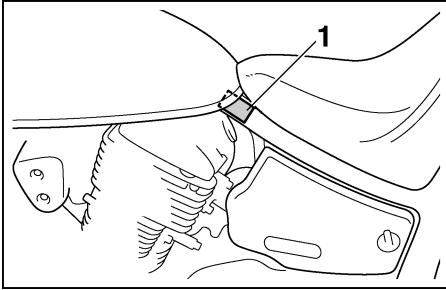

1. Model label

EAU01804

Model label

The model label is affixed to the frame under the rider seat. (See page 3-10 for rider seat removal and installation procedures.) Record the information on this label in the space provided. This information will be needed when ordering spare parts from a Yamaha dealer.

EAU01388

Motorcycle noise regulation (for Australia)

TAMPERING WITH NOISE CONTROL SYSTEM PROHIBITED:

Owners are warned that the law may prohibit:

- (a) The removal or rendering inoperative by any person other than for purposes of maintenance, repair or replacement, of any device or element of design incorporated into any new vehicle for the purpose of noise control prior to its sale or delivery to the ultimate purchaser or while it is in use; and
- (b) The use of the vehicle after such device or element of design has been removed or rendered inoperative by any person.

INDEX

A

Air filter element, cleaning6-11

B

Battery6-25

Brake and clutch levers, checking and lubricating6-22

Brake and shift pedals, checking and lubricating6-22

Brake fluid, changing6-20

Brake fluid level, checking.....6-19

Brake lever.....3-5

Brake lever free play, adjusting6-17

Brake light switch, adjusting6-18

Brake pads, checking.....6-19

Brake pedal.....3-6

Brake pedal position, adjusting6-18

C

Cables, checking and lubricating.....6-21

Carburetors, adjusting.....6-12

Care.....7-1

Clutch lever.....3-5

Clutch lever free play, adjusting6-16

Conversion table.....8-5

D

Dimmer switch3-4

E

Engine break-in5-4

Engine oil and oil filter element6-7

Engine stop switch.....3-4

Engine trouble warning light3-2

F

Final gear oil.....6-9

Front fork, checking6-23

Fuel3-7

Fuel cock.....3-7

Fuel consumption, tips for reducing5-4

Fuel tank cap.....3-6

Fuses, replacing6-27

H

Handlebar switches3-3

Headlight bulb, replacing6-29

Helmet holder3-11

High beam indicator light3-2

Horn switch3-4

I

Identification numbers9-1

Idling speed, adjusting.....6-12

Ignition circuit cut-off system.....3-16

Indicator and warning lights3-2

K

Key identification number9-1

L

Labels, location1-7

Luggage strap holders3-15

M

Main switch/steering lock3-1

Model label9-2

N

Neutral indicator light3-2

Noise regulation (for Australia)9-2

O

Oil level warning light3-2

P

Panel, removing and installing.....6-5

Parking.....5-5

Part locations2-1

Pass switch.....3-4

Periodic maintenance and lubrication chart6-2

Pre-operation check list.....4-1

S

Safety information1-1

Seats3-9

 Passenger seat.....3-9

 Rider seat3-10

Shifting.....5-3

Shift pedal.....3-5

Shock absorber assembly, adjusting	3-13
Sidestand	3-15
Sidestand, checking and lubricating.....	6-22
Spark plugs, checking	6-6
Specifications	8-1
Speedometer unit	3-3
Starter (choke) lever	3-9
Starting and warming up a cold engine	5-1
Starting a warm engine.....	5-3
Start switch.....	3-4
Steering, checking.....	6-23
Storage.....	7-4
Storage compartment	3-11

T

Throttle cable free play, adjusting	6-13
Throttle grip and cable, checking and lubricating.....	6-21
Tires	6-13
Tool kit.....	6-1
Troubleshooting.....	6-31
Troubleshooting chart	6-32
Turn signal indicator light	3-2
Turn signal or tail/brake light bulb, replacing	6-30
Turn signal switch.....	3-3

V

Valve clearance, adjusting	6-13
Vehicle identification number.....	9-1

W

Wheel bearings, checking	6-24
Wheels.....	6-15



PRINTED ON RECYCLED PAPER

PRINTED IN JAPAN
2000-8-0.3×1 CR
(E)