

GSX-S1000/A/F/FA

OWNER'S MANUAL



Way of Life!

This manual should be considered a permanent part of the motorcycle and should remain with the motorcycle when resold or otherwise transferred to a new owner or operator. The manual contains important safety information and instructions which should be read carefully before operating the motorcycle.

IMPORTANT

BREAK-IN (RUNNING-IN) INFORMATION FOR YOUR MOTORCYCLE

The first 1600 km (1000 miles) are the most important in the life of your motorcycle. Proper break-in operation during this time will help ensure maximum life and performance from your new motorcycle. Suzuki parts are manufactured of high quality materials, and machined parts are finished to close tolerances. Proper break-in operation allows the machined surfaces to polish each other and mate smoothly.

Motorcycle reliability and performance depend on special care and restraint exercised during the break-in period. It is especially important that you avoid operating the engine in a manner which could expose the engine parts to excessive heat.

Please refer to the BREAK-IN (RUNNING-IN) section for specific break-in recommendations.

▲ WARNING/▲ CAUTION/ NOTICE/NOTE

Please read this manual and follow its instructions carefully. To emphasize special information, the symbol ▲ and the words **WARNING**, **CAUTION**, **NOTICE** and **NOTE** have special meanings. Pay particular attention to messages highlighted by these signal words:

▲ WARNING

Indicates a potential hazard that could result in death or serious injury.

▲ CAUTION

Indicates a potential hazard that could result in minor or moderate injury.

NOTICE

Indicates a potential hazard that could result in vehicle or equipment damage.

NOTE: Indicates special information to make maintenance easier or instructions clearer.

FOREWORD

Motorcycling is one of the most exhilarating sports and to ensure your riding enjoyment, you should become thoroughly familiar with the information presented in this Owner's Manual before riding the motorcycle.

The proper care and maintenance that your motorcycle requires is outlined in this manual. By following these instructions explicitly you will ensure a long trouble free operating life for your motorcycle. Your authorized Suzuki dealer has experienced technicians that are trained to provide your machine with the best possible service with the right tools and equipment.

All information, illustrations and specifications contained in this manual are based on the latest product information available at the time of publication. Due to improvements or other changes, there may be some discrepancies between information in this manual and your motorcycle. Suzuki reserves the right to make changes at any time.

Please note that this manual applies to all specifications or all respective destinations and explains all equipment. Therefore, your model may have different standard features than shown in this manual.



TABLE OF CONTENTS

CONSUMER INFORMATION

1

CONTROLS

2

FUEL, ENGINE OIL AND COOLANT RECOMMENDATIONS

3

BREAK-IN (RUNNING-IN) AND INSPECTION BEFORE RIDING

4

RIDING TIPS

5

INSPECTION AND MAINTENANCE

6

TROUBLESHOOTING

7

STORAGE PROCEDURE AND MOTORCYCLE CLEANING

8

SPECIFICATIONS

INDEX

CONSUMER INFORMATION

ACCESSORY USE AND MOTORCYCLE LOADING	1-2
SAFE RIDING RECOMMENDATION FOR MOTORCYCLE RIDERS	1-4
LABELS	1-5
SERIAL NUMBER LOCATION	1-6
NOISE CONTROL SYSTEM (AUSTRALIA ONLY)	1-6

CONSUMER INFORMATION

ACCESSORY USE AND MOTORCYCLE LOADING

ACCESSORY USE

The addition of unsuitable accessories can lead to unsafe operating conditions. It is not possible for Suzuki to test each accessory on the market or combinations of all the available accessories; however, your dealer can assist you in selecting quality accessories and installing them correctly. Use extreme caution when selecting and installing the accessories on your motorcycle and consult your Suzuki dealer if you have any questions.

WARNING

Improper installation of accessories or modification of the motorcycle may cause changes in handling which could lead to an accident.

Never use improper accessories, and make sure that any accessories that are used are properly installed. All parts and accessories added to the motorcycle should be genuine Suzuki parts or their equivalent designed for use on this motorcycle. Install and use them according to their instructions. If you have any questions, contact your Suzuki dealer.

ACCESSORY INSTALLATION GUIDELINES

- Install aerodynamic-affecting accessories, such as a fairing, windshield, backrests, saddlebags, and travel trunks, as low as possible, as close to the motorcycle and as near the center of gravity as is feasible. Check that the mounting brackets and other attachment hardware are rigidly mounted.
- Inspect for proper ground clearance and bank angle. Inspect that the accessory does not interfere with the operation of the suspension, steering or other control operations.
- Accessories fitted to the handlebars or the front fork area can create serious stability problems. The extra weight will cause the motorcycle to be less responsive to your steering control. The weight may also cause oscillations in the front end and lead to instability problems. Accessories added to the handlebars or front fork of the machine should be as light as possible and kept to a minimum.
- Certain accessories displace the rider from his or her normal riding position. This limits the freedom of movement of the rider and may limit his or her control ability.
- Additional electrical accessories may overload the existing electrical system. Severe overloads may damage the wiring harness or create a dangerous situation due to the loss of electrical power during the operation of the motorcycle.
- Do not pull a trailer or sidecar. This motorcycle is not designed to pull a trailer or sidecar.

LOADING LIMIT

WARNING

Overloading or improper loading can cause loss of motorcycle control and an accident.

Follow loading limits and loading guidelines in this manual.

Never exceed the G.V.W. (Gross Vehicle Weight) of this motorcycle. The G.V.W. is the combined weight of the machine, accessories, payload, rider and passenger. When selecting your accessories, keep in mind the weight of the rider as well as the weight of the accessories. The additional weight of the accessories may not only create an unsafe riding condition but may also affect the riding stability.

G.V.W.: 400 kg (880 lbs)
at the tire pressure (cold)
Front: 250 kPa (2.50 kgf/cm², 36 psi)
Rear: 290 kPa (2.90 kgf/cm², 42 psi)

LOADING GUIDELINES

This motorcycle is primarily intended to carry small items when you are not riding with a passenger. Follow the loading guidelines below:

- Balance the load between the left and right side of the motorcycle and fasten it securely.
- Keep cargo weight low and as close to the center of the motorcycle as possible.
- Do not attach large or heavy items to the handlebars, front forks or rear fender.
- Do not install a luggage carrier or a luggage box protruding over the tail end of the motorcycle.
- Do not carry any items that protrude over the tail end of the motorcycle.
- Check that both tires are properly inflated to the specified tire pressure for your loading conditions. Refer to page 6-43.
- Improperly loading your motorcycle can reduce your ability to balance and steer the motorcycle. You should ride at reduced speeds, less than 130 km/h (80 mph), when you are carrying cargo or have added accessories.
- Adjust suspension setting as necessary.

WARNING

Placing objects in the space behind the fairing can interfere with steering and can cause loss of control.

Do not carry any objects in the space behind the fairing.

MODIFICATION

Modification of the motorcycle, or removal of original equipment may render the vehicle unsafe or illegal.

The frame of this motorcycle is made of an aluminium alloy. Therefore, never make any modifications such as drilling or welding to the frame as it weakens the strength of the frame significantly. Failure to heed this warning could result in an unsafe vehicle operating condition and subsequent accident. Suzuki will not be responsible in any way for personal injury or damage to the motorcycle caused by frame modifications. Bolt on accessories that do not modify the frame in any way may be installed provided that the GVW is not exceeded.

WARNING

Modification to an aluminum alloy frame, such as drilling or welding, weakens the frame. This could result in an unsafe operating condition and may lead to an accident.

Never make any modifications to the frame.

SAFE RIDING RECOMMENDATION FOR MOTORCYCLE RIDERS

Motorcycle riding is great fun and an exciting sport. Motorcycle riding also requires that some extra precautions be taken to ensure the safety of the rider and passenger. These precautions are:

WEAR A HELMET

Motorcycle safety equipment starts with a quality helmet. One of the most serious injuries that can happen is a head injury. ALWAYS wear a properly approved helmet. You should also wear suitable eye protection.

RIDING APPAREL

Loose, fancy clothing can be uncomfortable and unsafe when riding your motorcycle. Choose good quality motorcycle riding apparel when riding your motorcycle.

INSPECTION BEFORE RIDING

Review thoroughly the instructions in the "INSPECTION BEFORE RIDING" section of this manual. Do not forget to perform an entire safety inspection to ensure the safety of the rider and its passenger.

FAMILIARIZE YOURSELF WITH THE MOTORCYCLE

Your riding skill and your mechanical knowledge form the foundation for safe riding practices. We suggest that you practice riding your motorcycle in a non-traffic situation until you are thoroughly familiar with your machine and its controls. Remember practice makes perfect.

KNOW YOUR LIMITS

Ride within the boundaries of your own skill at all times. Knowing these limits and staying within them will help you to avoid accidents.

BE EXTRA SAFETY CONSCIOUS ON BAD WEATHER DAYS

Riding on bad weather days, especially wet ones, requires extra caution. Braking distances double on a rainy day. Stay off the painted surface marks, manhole covers and greasy appearing areas as they can be especially slippery. Use extreme caution at railway crossings and on metal gratings and bridges. Whenever in doubt about road condition, slow down!

RIDE DEFENSIVELY

The most common type of motorcycle accident occurs when a car traveling towards a motorcycle turns round corner in front of the motorcyclist. Ride defensively. Wise motorcyclist uses a strategy of assuming they are invisible to other drivers, even in broad daylight. Wear bright, reflecting clothing. Turn on the headlight and taillight every time even on a bright, sunny day to attract driver's attention. Do not ride in another driver's blind spot.

LABELS

Read and follow all the labels on the motorcycle. Make sure you understand all of the labels. Do not remove any labels from the motorcycle.

SERIAL NUMBER LOCATION

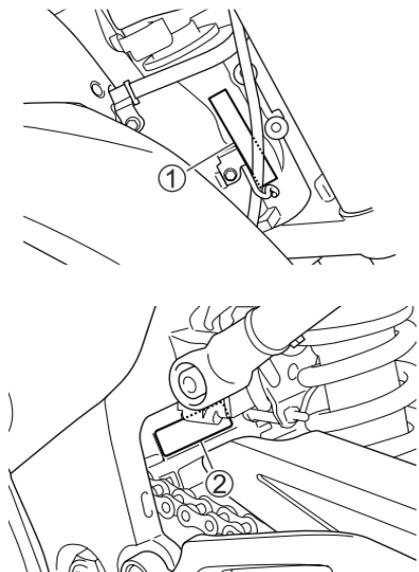

The frame and/or engine serial numbers are used to register the motorcycle. They are also used to assist your dealer when ordering parts or referring to special service information. The frame number ① is stamped on the steering head tube. The engine serial number ② is stamped on the crankcase assembly.

Please write down the numbers in the box provided below for your future reference.

Frame number:

Engine number:

NOISE CONTROL SYSTEM (AUSTRALIA ONLY)

TAMPERING WITH NOISE CONTROL SYSTEM PROHIBITED

Owners are warned that the law may prohibit:

- (a) The removal or rendering inoperative by any person other than for purposes of maintenance, repair or replacement, of any device or element of design incorporated into any new vehicle for the purpose of noise control prior to its sale or delivery to the ultimate purchaser or while it is in use; and
- (b) The use of the vehicle after such device or element of design has been removed or rendered inoperative by any person.

CONTROLS

LOCATION OF PARTS	2-2
KEY	2-5
IGNITION SWITCH	2-7
INSTRUMENT PANEL	2-10
LEFT HANDLEBAR	2-24
RIGHT HANDLEBAR	2-29
FUEL TANK CAP	2-32
GEARSHIFT LEVER	2-33
REAR BRAKE PEDAL	2-33
SEAT LOCK AND HELMET HOLDERS	2-34
LUGGAGE STRAPS	2-36
SIDE STAND	2-37
SUSPENSION ADJUSTMENT	2-38

CONTROLS

LOCATION OF PARTS

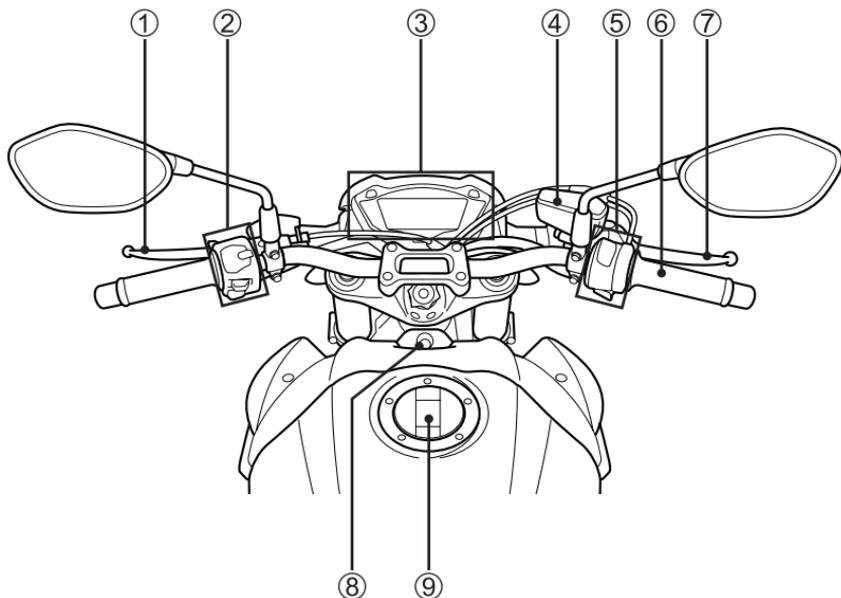

GSX-S1000/A

- ① Clutch lever
- ② Left handlebar switches
- ③ Instrument panel
- ④ Front brake fluid reservoir
- ⑤ Right handlebar switches
- ⑥ Throttle grip
- ⑦ Front brake lever
- ⑧ Ignition switch
- ⑨ Fuel tank cap

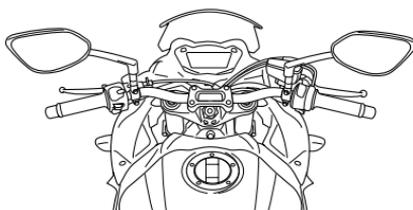

GSX-S1000F/FA

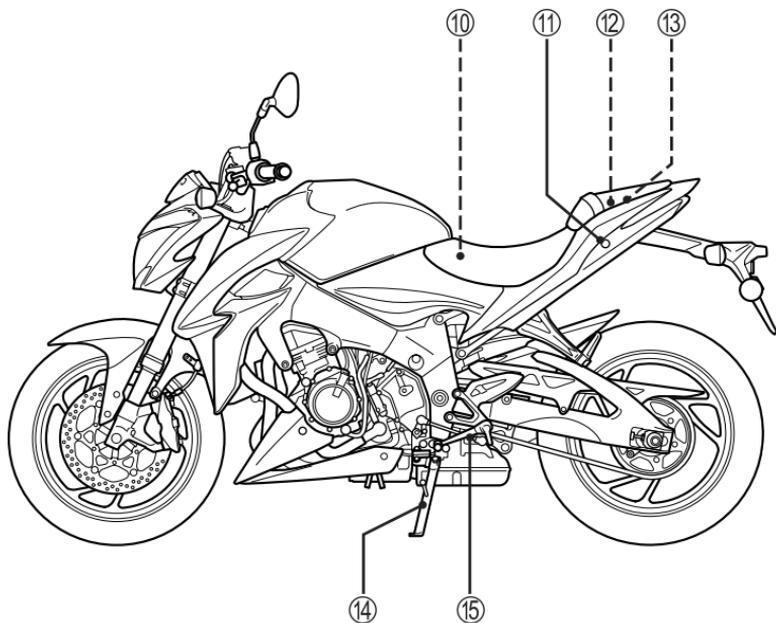

GSX-S1000/A

- ⑩ Battery
- ⑪ Seat lock
- ⑫ Tools
- ⑬ Helmet holders
- ⑭ Side stand
- ⑮ Gearshift lever

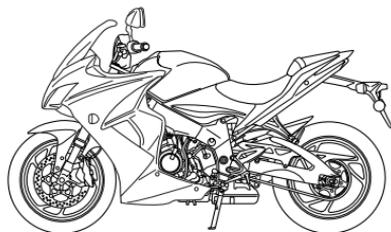

GSX-S1000F/FA

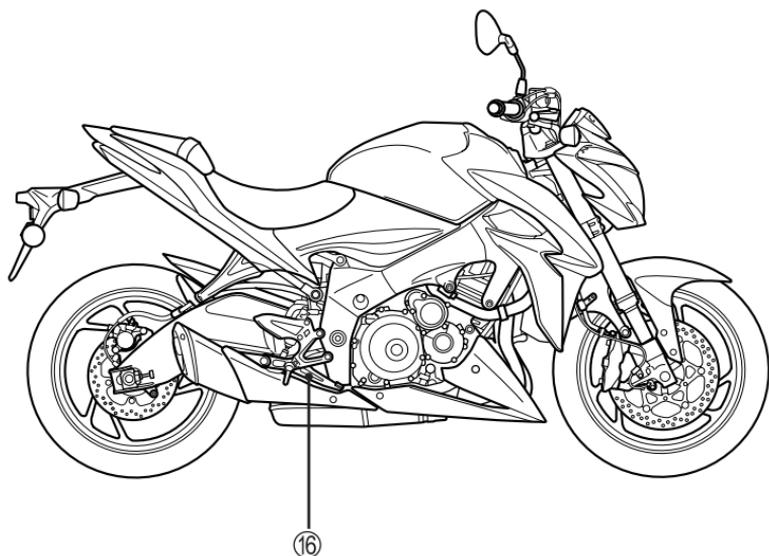

GSX-S1000/A

⑩ Rear brake pedal

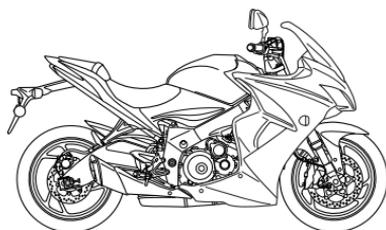

GSX-S1000F/FA

KEY

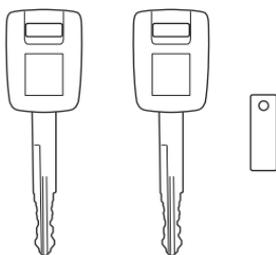

This motorcycle comes equipped with a pair of identical ignition keys. Keep the spare key in a safe place.

If the all keys are lost, the ECM should be replaced. (Immobilizer equipped model)

⚠ WARNING

A long key chain could get caught between the ignition switch and upper bracket. This could interfere with steering and cause loss of control.

Use the ignition key without key chains or other keys attached.

NOTICE

Attaching key holder or some chain to the ignition key can damage plated parts and painted parts around the ignition switch.

Use only the ignition key or a soft key holder to avoid plating and painting damage.

NOTE:

- *Immobilizer identification code is programmed into the key. Therefore, a key made by an ordinary locksmith will not work. Ask your Suzuki dealer if you need to make a spare key.*
- *If you loose the key, ask your Suzuki dealer to have the lost one deactivated.*
- *If you own other vehicles with immobilizer keys, keep those keys away from the ignition switch when using your motorcycle, or they may interfere with your motorcycle immobilizer system. The spare key for your motorcycle also may interfere with your motorcycle immobilizer system. Keep the spare key away from the ignition switch.*
- *Two keys are originally registered to the immobilizer system. It is possible to add two more keys. Ask your Suzuki dealer to make and register additional spare keys.*

IMMOBILIZER INDICATOR (if equipped)

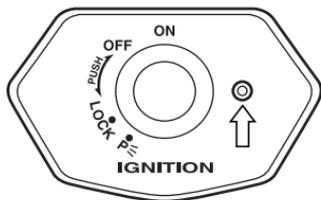

The immobilizer indicator blinks 2 times when the ignition switch is turned on. Then indicator comes on 2 seconds and goes off.

Immobilizer system is designed to help prevent motorcycle theft by electronically disabling the engine starting system. The engine can be started only with your original keys which have an electronic identification code programmed into it. The key communicates the identification code to the ECM when the key is turned to "ON" position.

NOTE:

- It is impossible to start the engine when the indicator remains blinking.
- If the indicator remains blinking, it means immobilizer system communication error between key and ECM or use of wrong key. Turn off the ignition switch and then turn on to communicate immobilizer system properly.
- Two ignition keys are originally registered to the immobilizer system. It is possible to add two more keys. The indicator blinks numbers of registered key when the ignition switch is turned on.

IGNITION SWITCH

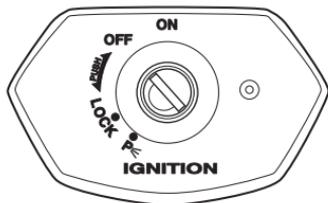

Immobilizer equipped model

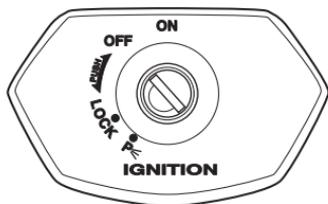

The ignition switch has 4 positions:

“OFF” POSITION

All electrical circuits are cut off. The engine will not start. The key can be removed.

“ON” POSITION

The ignition circuit is completed and the engine can now be started. The headlight and taillight will automatically be turned on when the key is in this position. The key cannot be removed from the ignition switch in this position.

NOTE: Start the engine promptly after turning the key to the “ON” position, or the battery will lose power due to consumption by the headlight and taillight.

“LOCK” POSITION

To lock the steering, turn the handlebar all the way to the left. Push down and turn the key to the “LOCK” position and remove the key. All electrical circuits are cut off.

“P” (Parking) POSITION

When parking the motorcycle, lock the steering and turn the key to the “P” position. The key can now be removed and the position light and taillight will remain lit and the steering will be locked. This position is for night time roadside parking to increase visibility.

WARNING

Turning the ignition switch to the “P” (PARKING) or “LOCK” position while the motorcycle is moving can be hazardous. Moving the motorcycle while the steering is locked can be hazardous. You could lose your balance and fall, or you could drop the motorcycle.

Stop the motorcycle and place it on the side stand before locking the steering. Never attempt to move the motorcycle when the steering is locked.

WARNING

If the motorcycle falls down due to a slip or collision, unexpected damage to the motorcycle could cause the engine to keep running, which could result in a fire, or could result in injury from moving parts such as the rear wheel.

If the motorcycle falls down, turn the ignition switch off immediately. Ask your authorized Suzuki dealer to inspect the motorcycle for unseen damage.

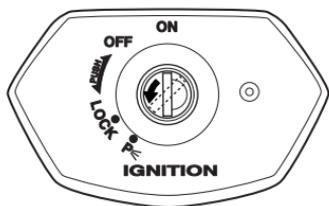

The key hole can be covered by turning the lid.

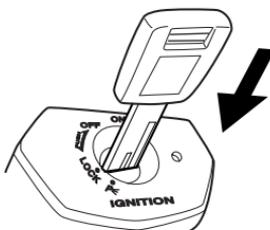
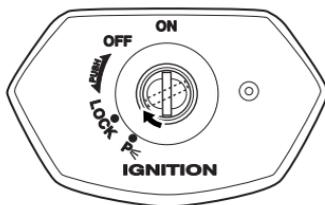
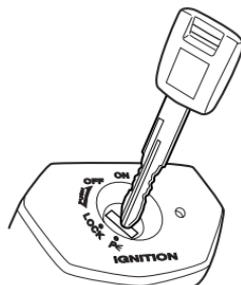

Align the lid hole position to the key hole position when inserting the key.

INSTRUMENT PANEL

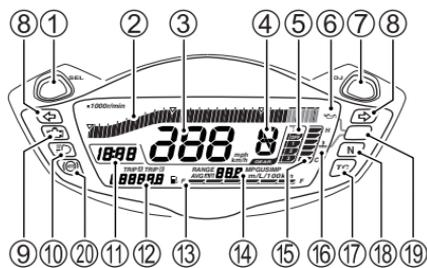

The malfunction indicator light ⑨, traction control system indicator light ⑰, coolant temperature indicator/oil pressure indicator light ⑲, ABS indicator light ⑳ (GSX-S1000A/FA), and LCD's work as follows to confirm their function when the ignition switch is turned to the "ON" position.

- The malfunction indicator light ⑨ comes on for 3 seconds.
- All LCD segments appear and then show the normal display.



When the ignition switch is turned on, all the LCD segments are displayed. At this time, if only km (km/h) is displayed on the LCD, switching to the mile (mph) indication is not available as the meter is of the km specification.

TACHOMETER ②

The tachometer indicates the engine speed in revolutions per minute (r/min).

Press and hold the SEL button ① and turn on the ignition switch. Hold the SEL button ① for 4 seconds to switch tachometer display pattern setting mode.

To change the display pattern, push the SEL button ①. The display pattern changes in the order below.

Normal → Negative/Positive reverse image → 1 segment → 2 segment → Peak hold → Normal

Push the ADJ button ⑦ and returns to the normal display.

SPEEDOMETER ③

The speedometer indicates the road speed in kilometers per hour or miles per hour.

NOTE:

- Press and hold the ADJ button ⑦ and turn on the ignition switch. Hold the ADJ button ⑦ for 4 seconds to switch between km/h and mph. At the same time, the odometer will be changed between km and mile.
- Select km/h or mph, as appropriate, to comply with traffic regulations.
- Check km/h and mph display after adjusting the instrument panel display.

GEAR POSITION INDICATOR ④

The gear position indicator indicates gear position. This indicator displays “N” when the transmission is in neutral.

NOTE: When the display indicates “CHEC” in the odometer display area, the gear position indicator does not indicate a number but indicates “-”.

TRACTION CONTROL SYSTEM DISPLAY ⑤

The setting of the traction control system is indicated by OFF, 1, 2 or 3.



NOTE: For more detailed information on the traction control system, see page 2-26.

NOTICE

Riding the motorcycle with the oil pressure indicator light lit can damage the engine and transmission.

If the oil pressure indicator light comes on, indicating low oil pressure, stop the engine immediately. Check the oil level and add oil if necessary. If there is a proper amount of oil and the light still does not go out, have your authorized Suzuki dealer or a qualified mechanic inspect your motorcycle.

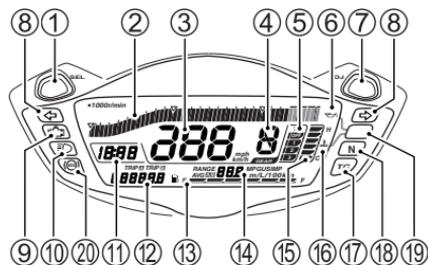

OIL PRESSURE INDICATOR “”

⑥

When the ignition switch is in the “ON” position but the engine has not been started, the symbol “” ⑥ in the display and the indicator light ⑱ comes on. As soon as the engine is started, the symbol “” ⑥ and the indicator light should go out.

When the engine oil pressure drops under the normal operating range, the symbol “” ⑥ in the display appears and the indicator light ⑱ comes on.

TURN SIGNAL INDICATOR LIGHT

“” ⑧

When the turn signals are being operated either to the right or to the left, the indicator light will blink intermittently.

NOTE: If a turn signal light is not operating properly due to bulb filament or circuit failure, the indicator light blinks more quickly to notify the rider of the existence of a problem.

MALFUNCTION INDICATOR LIGHT

“” ⑨

FI

If the fuel injection system fails, the malfunction indicator light ⑨ comes on and the display indicates “FI” in the odometer display area in the following two modes;

- A. The display ⑫ in the odometer display area alternately indicates “FI” and the odometer/trip meter reading, and the malfunction indicator light ⑨ comes on and remains lit.
- B. The display ⑫ in the odometer display area indicates “FI” continuously and the malfunction indicator light ⑨ blinks while cranking the engine.

The engine may continue to run in mode A, but the engine will not run in mode B.

NOTICE

The malfunction indicator light comes on to indicate a problem with the fuel injection system. Riding the motorcycle with the malfunction indicator lit can damage the engine and transmission.

If the display indicates “FI” and the malfunction indicator light comes on, have your authorized Suzuki dealer or a qualified mechanic inspect the fuel injection system as soon as possible.

NOTE:

- If the display indicates “FI” and the odometer/trip meter reading alternately, and the malfunction indicator light comes on and remains lit, keep the engine running and bring your motorcycle to an authorized Suzuki dealer. If the engine stalls, try restarting the engine after turning the ignition switch off and on.
- If the display indicates “FI” continuously and the malfunction indicator light blinks, the engine will not start.

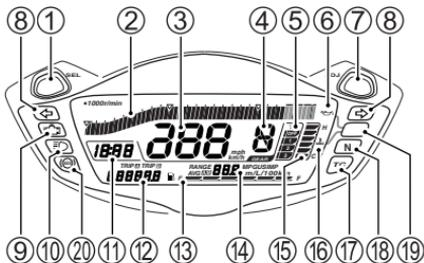

CHEC

When the display indicates “CHEC” in the odometer display area, check the following items;

- Make sure that the engine stop switch is in the “” position.
- Make sure that the transmission is in neutral or the side stand is fully up.

If the display still indicates “CHEC” after checking the above items, inspect the ignition fuse and the connection of the lead wire couplers.

HIGH BEAM INDICATOR LIGHT

“” (10)

This blue indicator light will be lit when the headlight high beam is turned on.

CLOCK (11)

12:00

Time is shown when the ignition switch is in the “ON” position. The clock has a 12-hour display. Follow the procedure below to adjust the clock.

To adjust the clock, press and hold the SEL button (1) and the ADJ button (7) simultaneously for 2 seconds until the clock hour display blinks.

Push the ADJ button (7) to adjust the hour display.

Push the SEL button (1) and the clock minute display blinks. Push the ADJ button (7) to adjust the minute display. Push the SEL button (1) to return to the clock mode.

NOTE:

- When the ADJ button (7) is pressed and held, the display will increase continuously.
- The clock can be adjusted when the ignition switch is in the “ON” position.
- This clock is powered by the battery of the motorcycle. If your motorcycle is to be left unused more than two months, remove the battery from the motorcycle.

ODOMETER/TRIP METER/ INSTRUMENT PANEL LIGHT BRIGHTNESS ⑫

The display has 4 functions; odometer, two trip meters, and instrument panel light brightness. When the ignition switch is turned to the "ON" position, the test pattern shown below is displayed for 2 seconds. After the test pattern is displayed, the display will show the function that was displayed the last time that the ignition switch was turned off.

TRIP A TRIP B
88888.8

NOTE:

- Press and hold the ADJ button ⑦ and turn on the ignition switch. Hold the ADJ button ⑦ for 4 seconds to switch between km and mile. At this time, the speedometer will be changed between km/h and mph and the instantaneous/average fuel economy meter will be changed between km/L (L/100 km) and MPG.
- Select km or mile, as appropriate, to comply with traffic regulations.
- Check the km and mile display after adjusting the instrument panel display.

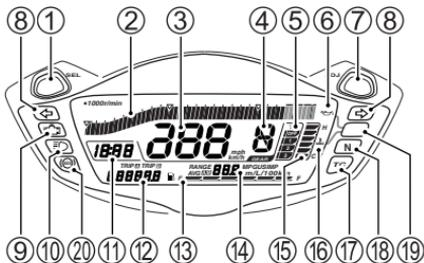

To change the display, push the SEL button ① or left handlebar MODE switch (Up). The display changes in the order below.

NOTE: When the traction control system select switch is pushed, the display cannot be changed with the left handlebar MODE switch because traction control select mode is active.

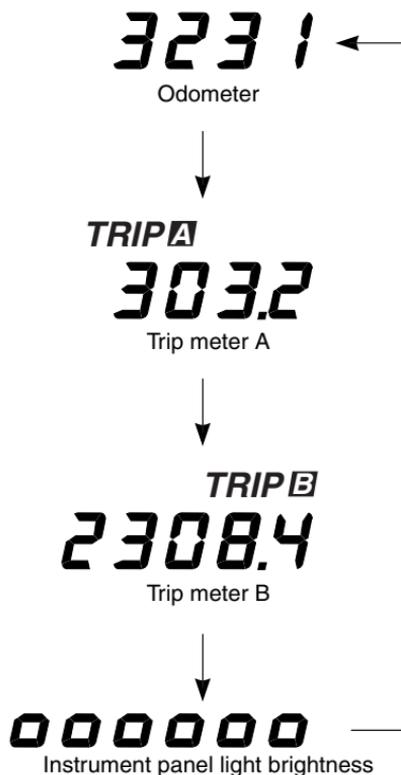

ODOMETER

The odometer registers the total distance that the motorcycle has been ridden. The odometer ranges from 0 to 999999.

The odometer display locks at 999999 when the total distance exceeds 999999.

TRIP METERS

The two trip meters are resettable odometers. They can register two kinds of distances at the same time. For instance, trip meter A can register the trip distance and trip meter B can register the distance between fuel stops.

To reset a meter to zero, press and hold the ADJ button ⑦ or MODE switch (Up) for 2 seconds while the display indicates the trip meter A or B, you want to reset. When you reset the trip meter A or B, the fuel economy meter will also be reset.

NOTE: When the trip meter exceeds 9999.9, the trip meter will return to 0.0 and start counting again.

INSTRUMENT PANEL LIGHT BRIGHTNESS

Set the meter to instrument panel light brightness, then press and hold the ADJ button ⑦ or MODE switch (Up) for 2 seconds until the “” mark indicators blink. Pushing the SEL button ① or MODE switch (Up) will change the instrument panel light brightness in 6 steps. The brightness indicator indicates brightness from “” (min) to “” (max). Push the ADJ button ⑦ or MODE switch (Down) to return to instrument panel light brightness mode.

NOTE: If the traction control system select switch is pressed (selection of traction mode) during instrument panel light brightness adjustment (while blinking), the instrument panel light brightness cannot be adjusted or confirmed with the handlebar MODE switch. In this case, use the SEL/ADJ button to adjust/confirm the instrument panel light brightness or press the traction control system select switch again (cancellation of traction mode selection) so that the instrument panel light brightness can be adjusted and confirmed with the handlebar MODE switch.

WARNING

Changing the display while riding can be hazardous. Removing a hand from the handlebars can reduce your ability to control the motorcycle.

Never change the display while riding. Keep both hands on the handlebars.

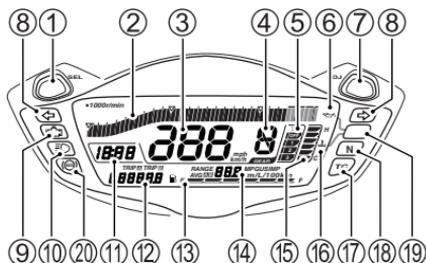

FUEL METER “” ⑬

The fuel meter indicates the amount of fuel remaining in the fuel tank. The fuel meter displays all 6 segments when the fuel tank is full. The mark blinks when the fuel level drops below 4.2 L (4.4/3.7 US/Imp qt). The mark and segment blink when the fuel drops below 1.7 L (1.8/1.5 US/Imp qt).

Fuel tank	Approximately 1.7 L	Approximately 4.2 L	Full
Fuel gauge			
 mark	Blink	Blink	

NOTE:

- The fuel meter will not indicate correctly when the motorcycle is placed on the side stand. Turn the ignition switch to the “ON” position when the motorcycle is held upright.
- If the fuel mark blinks, fill the fuel tank immediately. Also, the last segment of the fuel meter blinks when the fuel tank is almost empty.

DRIVING RANGE METER/ INSTANTANEOUS FUEL ECONOMY METER/AVERAGE FUEL ECONOMY METER ⑭

The display has 3 functions; driving range meter, instantaneous fuel economy meter and average fuel economy meter. When the ignition switch is turned to the “ON” position, the test pattern shown below is displayed for 3 seconds.

RANGE **888** MPGUSIMP
AVG  **888** km/L/100km

After the test pattern is displayed, the display will show the function that was displayed the last time that the ignition switch was turned off.

To change the display, push the ADJ button (7) or left handlebar MODE switch (Down). The display changes in the order below.

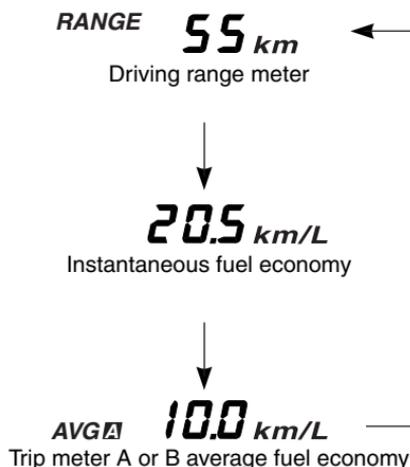

Driving range meter

The driving range meter displays estimated driving range (distance) based on the remaining fuel within the range from 1 to 999 km (mile). The driving range is recalculated when you refuel, but the indication may not change when only a small amount of fuel is added.

The driving range will not be recalculated when the motorcycle is placed on the side stand. Check the estimated driving range (distance) when the side stand is retracted. When the battery is disconnected, the driving range meter will be reset. When this happens, the meter indicates “- -” until the motorcycle is ridden for a certain distance.

NOTE:

- The driving range (distance) is an estimated value. The indication may not be the same as the actual driving distance.
- The meter does not use the average fuel economy value to calculate driving range (distance) and the calculation result may not be the same as indicated by the average fuel economy meter.
- To avoid running out of gasoline, you should not continue to ride the motorcycle until the estimated driving range drops to 1.

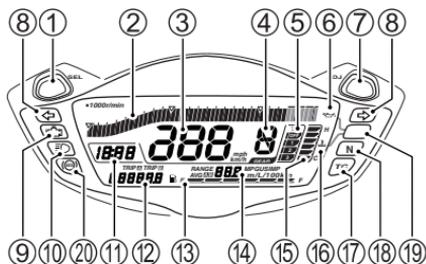

Instantaneous Fuel Economy Meter and Average Fuel Economy Meter

To change between “km/L (L/100 km)” and “MPG”, press and hold the ADJ button ⑦ and turn on the ignition switch. Hold the ADJ button ⑦ for 4 seconds to switch between km and mile. At the same time, the odometer will be changed between km and mile.

To change between “km/L” and “L/100 km”, set the meter ⑭ to either instantaneous fuel economy meter or average fuel economy meter and hold the SEL button ① or MODE switch (Down) for 2 seconds.

Instantaneous fuel economy meter

The instantaneous fuel economy meter displays the fuel consumption value only when the motorcycle is moving. However, when the motorcycle is stopping, the fuel economy meter displays “- - -”. This meter ranges from 0.1 to 50.0 (km/L), from 2.0 to 50.0 (L/100 km), or from 0.1 to 99.9 (MPG IMP).

NOTE: The display shows estimated values. Indications may not be the same as actual values.

Average fuel economy meter

The average fuel economy meter displays average fuel economy ratio of trip A or trip B. The average fuel economy meter ranges from 0.1 to 50.0 (km/L), from 0.1 to 99.9 (MPG IMP) or from 2.0 to 50.0 (L/100 km). The average fuel economy meter indicates “- - . -” when the trip meter indicates 0.0. To reset the fuel economy meter, reset the trip meter.

NOTE: The display shows estimated values. Indications may not be the same as actual values.

COOLANT TEMPERATURE METER

“” ⑮

The coolant temperature is displayed by an LCD segment temperature indicator ⑮, water temperature mark ⑯, and indicator light ⑰.

When the coolant temperature exceeds 116°C (241°F), all six LCD segments turn on. When the coolant temperature comes to 120°C (248°F), the water temperature mark ⑯ blinks, and the indicator light ⑰ turns on. If all six LCD segments for the temperature indication ⑮ turn on, stop the engine, wait until the engine is cooled, and check the coolant level.

NOTICE

Riding the motorcycle with the coolant temperature indicator lit can cause serious engine damage due to overheating.

If the engine coolant temperature indicator light comes on, stop the engine to let it cool. Do not run the engine until the coolant temperature indicator light goes off.

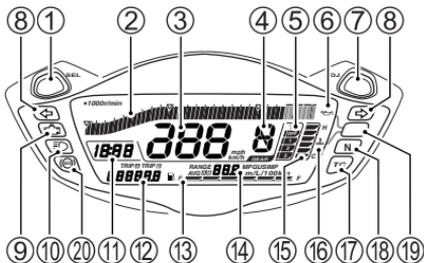

TRACTION CONTROL SYSTEM INDICATOR LIGHT “TC” ⑰

When the traction control system is turned off, the traction control system indicator light remains lit.

When the traction control system is set to Mode 1, Mode 2 or Mode 3, the traction control system indicator light indicates as follows.

- The indicator comes on when the ignition switch is turned “ON” and goes off after the motorcycle speed exceeds 5 km/h (3 mph).
- The indicator comes on and remains on when the traction control system is not working due to a system malfunction.
- The indicator blinks when the traction control system senses rear wheel spin and is controlling engine power output.
- The indicator remains off when the traction control system is monitoring the traction of the rear wheel during acceleration.

▲ WARNING

Riding the motorcycle with the traction control system turned on and the traction system indicator light lit can be hazardous.

If the traction control system indicator light comes on while riding, stop the motorcycle in a safe place and turn off the ignition switch. Turn the ignition switch “ON” after a while and check whether the indicator light comes on.

- If the indicator light goes off after starting to ride, the traction control system will be functioning.
- If it does not go off after starting to ride, the traction control system is not functioning. You should have the system checked by an authorized Suzuki dealer as soon as possible.

NOTE: For more detailed information on the traction control system, see page 2-26.

NEUTRAL INDICATOR LIGHT “N”

⑱

The green light will come on when the transmission is in neutral. The light will go out when you shift into any gear other than neutral.

ABS INDICATOR LIGHT “(ABS)” ②⑩ (GSX-S1000A/FA)

This indicator normally comes on when the ignition switch is turned “ON” and goes off after the motorcycle speed exceeds 5 km/h (3 mph).

If there is a problem with the ABS (Anti-lock Brake System), this indicator light blinks or comes on. The ABS does not operate when the ABS indicator light is on or blinking.

NOTE: If the ABS indicator light goes off before starting the motorcycle, check the ABS indicator light function by turning off and on the ignition switch. The ABS indicator light can go off if the engine is revved at high speed before starting the motorcycle. If the ABS indicator light does not come on when the ignition switch is turned on, you should have the system checked by an authorized Suzuki dealer as soon as possible.

WARNING

Riding the motorcycle with the ABS indicator light on can be hazardous.

If the ABS indicator light blinks or comes on while riding, stop the motorcycle in a safe place and turn off the ignition switch. Turn the ignition switch “ON” after a while and check if the indicator light comes on.

- **If the indicator light goes off after starting to ride, the ABS will be functioning.**
- **If it does not go off after starting to ride, ABS is not functioning, and the brakes provide normal stopping ability. You should have the system checked by an authorized Suzuki dealer as soon as possible.**

LEFT HANDLEBAR

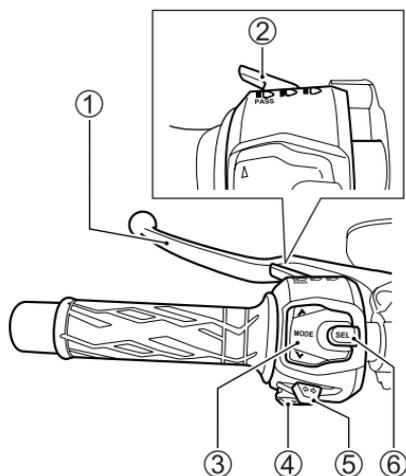

CLUTCH LEVER ①

The clutch lever is used for disengaging the drive to the rear wheel when starting the engine or shifting transmission gears. Squeezing the lever disengages the clutch.

DIMMER SWITCH ②

“☰” position

The headlight low beam and taillight turn on.

“☰☷” position

The headlight high beam and taillight turn on. The high beam indicator light also turns on.

Headlight flasher switch

Press the switch to flash the headlight.

NOTICE

Sticking tape or placing objects in front of the headlight can obstruct headlight heat radiation. This can result in headlight damage.

Do not stick tape on the headlight or place objects in front of the headlight.

NOTICE

Do not put objects in front of the headlight or taillight when they are on, and do not cover with clothes when the motorcycle is stopped.

This may cause melting of the lens or damage to the object by the heat from the lens.

MODE SWITCH ③

The MODE SWITCH has the same function as the SELECT switch. Refer to the INSTRUMENT PANEL and TRACTION CONTROL SYSTEM sections for details.

NOTE: For more detailed information on the traction control system, see page 2-26.

HORN SWITCH “” ④

Press the switch to sound the horn.

TURN SIGNAL LIGHT SWITCH

“” ⑤

Moving the switch to the “” position will flash the left turn signals. Moving the switch to the “” position will flash the right turn signals. The indicator light will also flash intermittently. To cancel turn signal operation, push the switch in.

WARNING

Failure to use the turn signals, and failure to turn off the turn signals can be hazardous. Other drivers may misjudge your course and this may result in an accident.

Always use the turn signals when you intend to change lanes or make a turn. Be sure to turn off the turn signals after completing the turn or lane change.

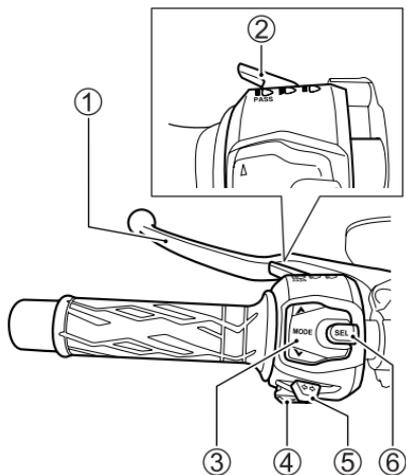

TRACTION CONTROL SYSTEM SELECT SWITCH ⑥

Traction control system

When the traction control system senses rear wheel spin during acceleration, it automatically controls engine power output to restore the gripping power of the rear tire. The traction control system indicator light blinks when the traction control system is controlling engine power output.

⚠ WARNING

Relying too much on the traction control system can be hazardous.

The traction control system cannot provide control to limit rear wheel spin under certain conditions. The system cannot control rear wheel spin resulting from high speed cornering, excessive bank angle, braking operation or engine braking effect. Be sure to operate the motorcycle at an appropriate speed according to your riding skill, weather and road conditions.

⚠ WARNING

Replacing the tires with other than the specified tires can be hazardous.

When replacing tires, be sure to mount the specified tires. If tires other than the specified size or type are mounted on the motorcycle, the traction control system will not be able to control engine power output properly.

NOTE:

- *When the traction control system is controlling engine power output, the engine sound and exhaust sound will change.*
- *When the front tire is not in full contact with the road surface due to sudden acceleration or other reasons, the traction control system will control engine power output.*
- *When the front or rear tires do not stay in full contact with the road surface, such as when riding on a bumpy road, the traction control system will control engine power output.*
- *When the traction control system is controlling engine power output, the engine speed will not increase even if the throttle grip is operated to increase engine power. If this happens, close the throttle completely to restore the normal condition.*

The traction control system can be set to OFF, Mode 1, Mode 2 or Mode 3.

<OFF>

The traction control system does not control engine power output even if the rear tire spins.

<Mode 1>

The sensitivity level of the traction control system is set low in this mode, so the traction control system allows a certain degree of wheel spin before controlling engine power output.

<Mode 2>

The sensitivity level of the traction control system is set middle in this mode, so the traction control system allows a lesser degree of wheel spin than when set in Mode 1 before controlling engine power output.

<Mode 3>

The sensitivity level of the traction control system is set high in this mode, so the traction control system allows a lesser degree of wheel spin than when set in Mode 2 before controlling engine power output.

 **WARNING**

Failure to confirm that the traction control system is in the intended mode before operating the motorcycle can be hazardous.

Confirm that the traction control system is in the intended mode before operating the motorcycle.

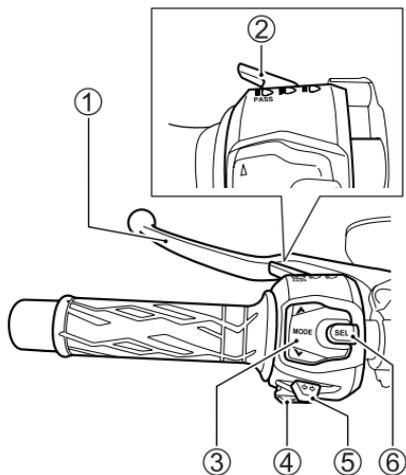

MODE SETTING

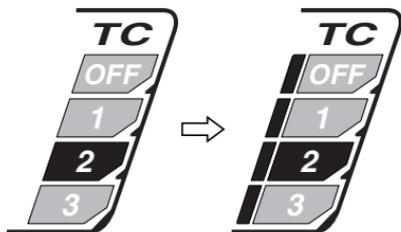

1. Press the traction control system select switch ⑥ for mode selection.



2. Press the Mode switch (UP, DOWN) ③ and change the indication on the traction control system display in the meter cluster to the desired mode. The display changes as shown in figure.
3. Press the traction control system select switch ⑥ to cancel the mode selection. The traction control system display in the meter cluster returns to the normal display mode.

NOTE:

- Be sure to keep the throttle fully closed when changing the mode. If the change of mode is not possible because the throttle is not fully closed, a segment of the selected mode on the traction control system display blinks.
- The setting is retained in the memory even when the ignition switch is turned off.
- The setting of the traction control system is retained in the memory even when the battery becomes fully discharged or is disconnected and removed from the motorcycle.

RIGHT HANDLEBAR

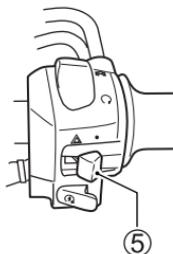
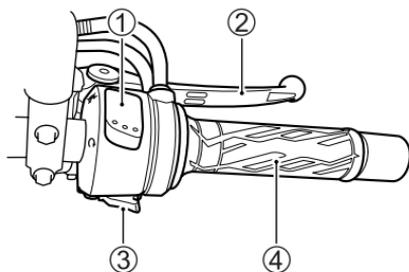

(EU)

ENGINE STOP SWITCH ①

“” position

The ignition circuit is off. The engine cannot start or run.

“” position

The ignition circuit is on and the engine can run.

FRONT BRAKE LEVER ②

The front brake is applied by squeezing the brake lever gently toward the throttle grip. This motorcycle is equipped with a disk brake system and excessive pressure is not required to slow the machine down properly. The brake light will be lit when the lever is squeezed inward.

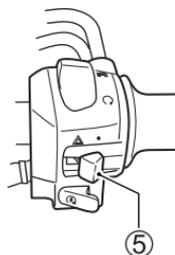
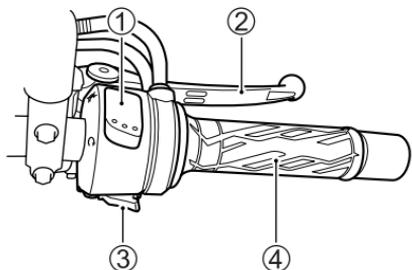

(EU)

Front Brake Lever Adjustment

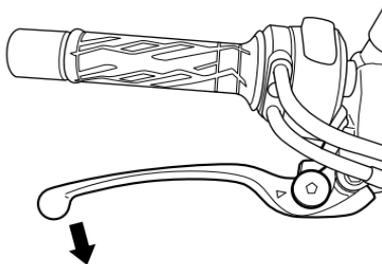

The distance between the throttle grip and the front brake lever is adjustable to 6 positions. To change the position, push the brake lever forward and turn the adjuster to the desired position. When changing the brake lever position, always be sure the adjuster stops in the proper position; a projection of the brake lever pivot should fit into the depression of the adjuster. This motorcycle is delivered from the factory with its adjuster set on position 3.

WARNING

Adjusting the front brake lever position while riding can be hazardous. Removing a hand from the handlebars can reduce your ability to control the motorcycle.

Never adjust the front brake lever position while riding. Keep both hands on the handlebars.

ELECTRIC STARTER SWITCH “ ③

This switch is used for operating the starter motor. With the ignition switch in the “ON” position, the engine stop switch in “

NOTE: When the electric starter switch is pushed, the starter motor will continue turning for about 1.5 seconds even when you release your hand from the switch. After elapsing about 1.5 second, or when the engine is started, the starter motor will stop automatically.

NOTE: This motorcycle is equipped with an interlock system for the ignition circuit and the starter circuit. The engine can only be started if:

- The transmission is in neutral, or
- The transmission is in gear, the side stand is fully up and the clutch is disengaged.

NOTE: The headlight will go off when the electric starter switch is pushed.

NOTICE

Engaging the starter motor for more than five seconds at a time can damage the starter motor and wiring harness from overheating.

Do not engage the starter motor for more than five seconds at a time. If the engine does not start after several attempts, check the fuel supply and ignition system. Refer to the TROUBLESHOOTING section in this manual.

THROTTLE GRIP Engine speed is controlled by the position of the throttle grip. Twist it toward you to increase engine speed. Turn it away from you to decrease engine speed.

HAZARD WARNING SWITCH “ ⑤ (EU)

All four turn signal lights and indicators will flash simultaneously when the switch is turned on with the ignition switch in the “ON” or “P” position. Use the hazard warning lights to warn other traffic during emergency parking or when your vehicle could otherwise become a traffic hazard.

FUEL TANK CAP

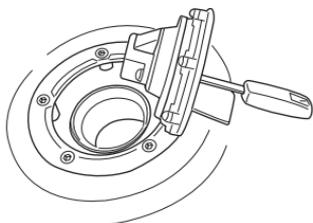
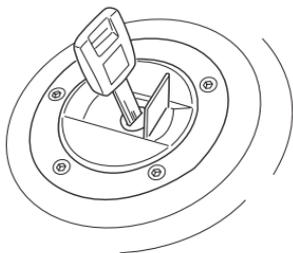

To open the fuel tank cap, insert the ignition key into the lock and turn it clockwise. With the key inserted, lift up with the key and open the fuel tank cap. To close the fuel tank cap, push the cap down firmly with the key in the cap lock.

Use fresh gasoline when filling up the fuel tank. Do not use bad gasoline which is contaminated with dirt, dust, water or other liquid. Be careful that dirt, dust or water does not enter the fuel tank when refueling.

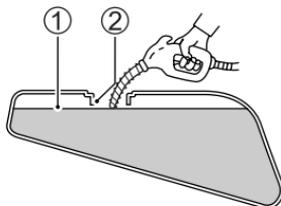

- ① Fuel level
- ② Filler neck

⚠ WARNING

If you overfill the fuel tank, fuel may overflow when it expands due to engine heat or heating by the sun. Fuel that overflows can catch fire.

Stop adding fuel when the fuel level reaches the bottom of the filler neck.

⚠ WARNING

Failure to follow safety precautions when refueling could result in a fire or cause you to breathe toxic fumes.

Refuel in a well ventilated area. Make sure the engine is off and avoid spilling fuel on a hot engine. Do not smoke, and make sure there are no open flames or sparks in the area. Avoid breathing gasoline vapors. Keep children and pets away when you refuel the motorcycle.

GEARSHIFT LEVER

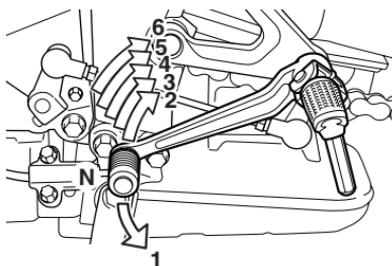

This motorcycle has a 6-speed transmission which operates as shown. To shift properly, squeeze the clutch lever and close the throttle at the same time you operate the gearshift lever. Lift the gearshift lever to upshift and depress the lever to downshift. Neutral is located between 1st and 2nd gear. When neutral is desired, depress or lift the lever halfway between 1st and 2nd gear.

NOTE: When the transmission is in neutral, the green indicator light on the instrument panel will be lit. However, even though the light is illuminated, cautiously and slowly release the clutch lever to make sure that the transmission is positively in neutral.

Reduce the motorcycle speed before down-shifting. When down-shifting, the engine speed should be increased before the clutch is engaged. This will prevent unnecessary wear on the drive train components and the rear tire.

REAR BRAKE PEDAL

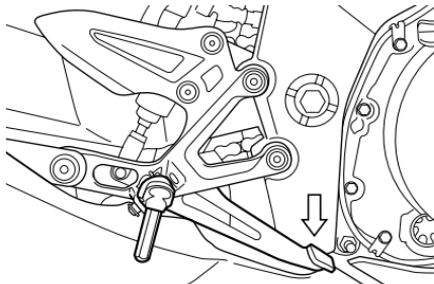

Depressing the rear brake pedal will apply the rear disk brake. The brake light will be illuminated when the rear brake is operated.

SEAT LOCK AND HELMET HOLDERS

SEAT LOCK

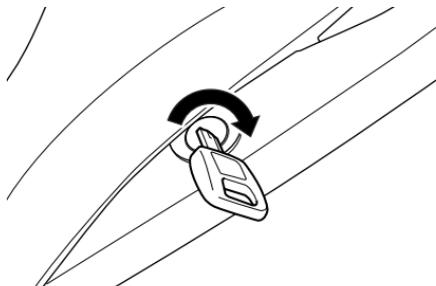

The seat lock is located under the left frame cover. To remove the rear seat, insert the ignition key into the lock and turn it clockwise. Raise the front end of the seat and slide it forward.

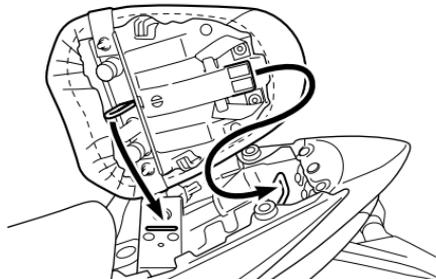

To reinstall the rear seat, slide the seat hooks into the seat hook retainers and push down firmly until the seat snaps into the locked position.

WARNING

Failure to install the seat properly could allow the seat to move and cause loss of rider control.

Latch the seat securely in its proper position.

FRONT SEAT REMOVAL

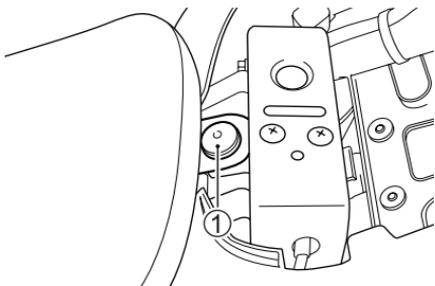

1. Remove the rear seat. Remove the bolt ①.

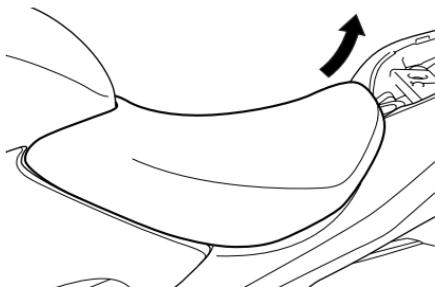

2. Raise the rear end of the seat and slide it backward.



To reinstall the front seat, slide the seat hooks into the seat hook retainers on the frame and tighten the bolt securely.

⚠ WARNING

Failure to install the seat properly could allow the seat to move and cause loss of rider control.

Fasten the seat securely in its proper position.

HELMET HOLDERS

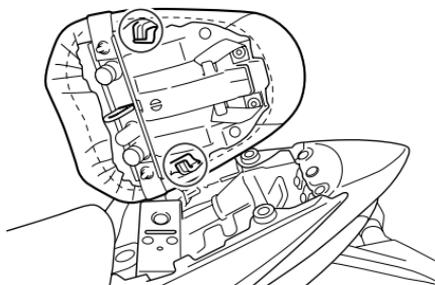

There are helmet holders underneath the rear seat. To use them, remove the seat, hook your helmet to the helmet holder and refit the seat.

▲ WARNING

Riding with a helmet fastened to the helmet holder can interfere with rider control.

Never carry a helmet fastened to the helmet holder. Fix the helmet securely atop the seat if you must carry it.

LUGGAGE STRAPS

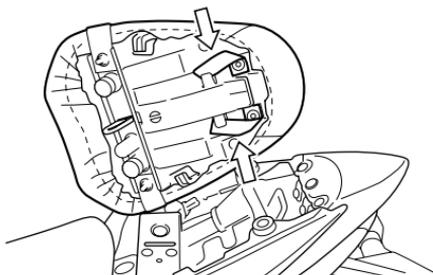

The luggage straps are folded under the seat. Extract the straps from the hooks and reinstall the seat with the straps out. Hook bands to the straps to fix luggage on the seat.

SIDE STAND

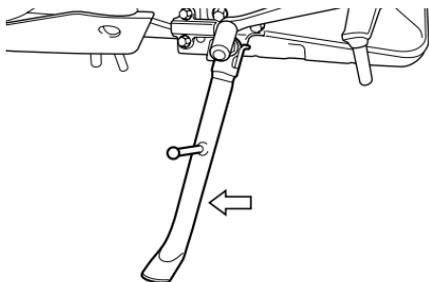

An interlock system is provided to cut off the ignition circuit when the side stand is down and the transmission is in any gear other than neutral.

The side stand/ignition interlock system works as follows:

- If the side stand is down and the transmission is in gear, the engine can not be started.
- If the engine is running and the transmission is shifted into gear with the side stand down, the engine will stop running.
- If the engine is running and the side stand is put down with the transmission in gear, the engine will stop running.

WARNING

Riding with the side stand incompletely retracted can result in an accident when you turn left.

Check operation of the side stand/ignition interlock system before riding. Always retract the side stand completely before starting off.

NOTICE

If you do not take proper precautions when parking, the motorcycle can fall over.

Park the motorcycle on firm, level ground whenever possible. If you must park on an incline, aim the front of the motorcycle uphill and put the transmission into 1st gear to reduce the possibility of rolling off the side stand.

SUSPENSION ADJUSTMENT

The standard settings for both the front and rear suspensions are selected to meet various riding conditions such as low to high motorcycle speed and light to heavy load on the motorcycle. The suspension settings can be adjusted and fine-tuned according to your preference.

NOTICE

Turning adjusters by force can damage the suspensions.

Do not turn adjusters beyond their natural limits.

FRONT SUSPENSION Spring Pre-load Adjustment

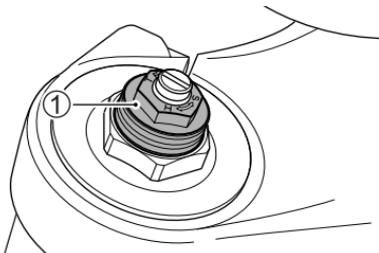

To change the spring pre-load, turn the adjuster ① clockwise or counterclockwise. Turning the adjuster clockwise will increase the spring pre-load. Turning the adjuster counterclockwise will decrease the spring pre-load. There are 5 grooved lines on the side of the adjuster ① for reference. Position 1 provides the minimum spring pre-load and position 5 provides the maximum pre-load. This motorcycle is delivered from the factory with its adjuster set on position 2.5.

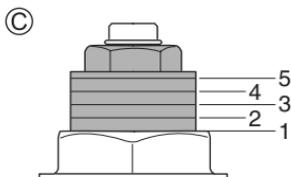
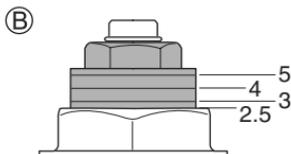
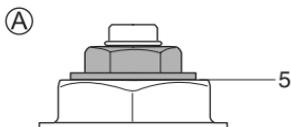

- Ⓐ Position 5
- Ⓑ Position 2.5
- Ⓒ Position 1

WARNING

Unequal suspension adjustment can cause poor handling and instability.

Adjust the right and left front forks to the same setting.

Damping Force Adjustment

The rebound and compression damping force can be individually adjusted by turning the respective adjusters. The rebound damping force adjusters ② are located at the top of the front suspension. The compression damping force adjusters ③ are located at the bottom of the front suspension.

To adjust the damping force, set the adjuster to the standard setting first and then adjust the adjuster to the desired position.

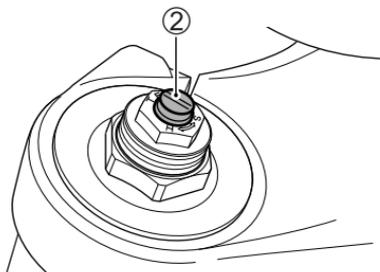

To set the rebound damping force adjuster to the standard position, turn the adjuster clockwise until it stops and then turn it counterclockwise 8 clicks.

Turn the adjuster clockwise from the standard position to stiffen the damping force. Turn the adjuster counterclockwise to soften the damping force. The damping force should be adjusted gradually, 1 click at a time, to fine-tune the suspension.

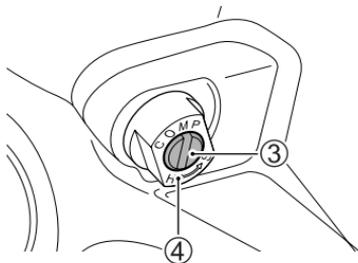

To set the compression damping force adjuster to the standard position, turn the adjuster clockwise until it stops and then turn it counterclockwise 8 clicks.

Turn the adjuster clockwise from the standard position to stiffen the damping force. Turn the adjuster counterclockwise to soften the damping force. The damping force should be adjusted gradually, 1 click at a time, to fine-tune the suspension.

NOTE: Do not loosen the adjuster base ④, or front fork oil will ooze through the adjuster base.

WARNING

Unequal suspension adjustment can cause poor handling and instability.

Adjust the right and left front forks to the same setting.

REAR SUSPENSION Spring Pre-load Adjustment



The rear suspension spring pre-load is adjustable to compensate for the rider, load, riding style and road conditions. The spring pre-load is adjustable to 7 positions. To change the spring pre-load setting, place the motorcycle on the side stand. Twist the spring tension ring to the desired position with the adjuster provided in the tool kit. Position 1 provides the softest spring tension and position 7 provides the stiffest. This motorcycle is delivered from the factory with its adjuster set on position 4 (GSX-S1000/A), position 3 (GSX-S1000F/FA).

Rear Suspension Label

WARNING



This unit contains high-pressure nitrogen gas. Mishandling can cause explosion.

- Keep away from fire and heat.
- Read owner's manual for more information.

*NOTE: Ask your Suzuki dealer to dis-
pose of the rear suspension unit.*

Damping Force Adjustment

The rebound damping force can be adjusted by turning the adjuster ①. The rebound damping force adjuster ① is located at the bottom of the rear suspension.

To adjust the damping force, set the adjuster to the standard setting first and then adjust the adjuster to the desired position.

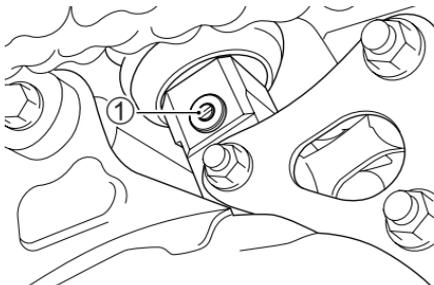

To set the rebound damping force adjuster to the standard position, turn the adjuster clockwise until it stops and then turn it counterclockwise 1 turn.

Turn the adjuster clockwise from the standard position to stiffen the damping force. Turn the adjuster counterclockwise to soften the damping force. The damping force should be adjusted gradually, 1/8 turn at a time, to fine-tune the suspension.



FUEL, ENGINE OIL AND COOLANT RECOMMENDATIONS

FUEL OCTANE RATING 3-2
OXYGENATED FUEL RECOMMENDATION 3-2
ENGINE OIL 3-4
ENGINE COOLANT SOLUTION 3-5

FUEL, ENGINE OIL AND COOLANT RECOMMENDATIONS

FUEL OCTANE RATING

Use premium unleaded gasoline with an octane rating of 95 or higher (Research method). Unleaded gasoline can extend spark plug life and exhaust components life.

(Canada)

Your motorcycle requires premium unleaded gasoline whenever possible, with a minimum pump octane rating of 90 ((R+M)/2 method). In some areas, the only fuels that are available are oxygenated fuels.

NOTE:

- *The GSX-S1000/A/F/FA engine is designed to use premium unleaded gasoline only. Use premium unleaded gasoline under all riding conditions.*
- *If the engine develops some trouble like lack of acceleration or insufficient power, the cause may be due to the fuel the motorcycle uses. In such case, try changing the gas station to another. If the situation is not improved by changing, consult your Suzuki dealer.*

OXYGENATED FUEL RECOMMENDATION

(Canada, EU)

Oxygenated fuels which meet the minimum octane requirement and the requirements described below may be used in your motorcycle without jeopardizing the New Vehicle Limited Warranty or the Emission Control System Warranty.

NOTE: Oxygenated fuels are fuels which contain oxygen carrying additives such as MTBE or alcohol.

Gasoline Containing MTBE

Unleaded gasoline containing MTBE (Methyl Tertiary Butyl Ether) may be used in your motorcycle if the MTBE content is not greater than 15%. This oxygenated fuel does not contain alcohol.

Gasoline/Ethanol Blends

Blends of unleaded gasoline and ethanol (grain alcohol), also known as "GASOHOL", may be used in your motorcycle if the ethanol content is not greater than 10%.

Gasoline/Methanol Blends

Fuels containing 5% or less methanol (wood alcohol) may be suitable for use in your motorcycle if they contain co-solvents and corrosion inhibitors.

DO NOT USE fuels containing more than 5% methanol under any circumstances. Fuel system damage or motorcycle performance problems resulting from the use of such fuels are not the responsibility of Suzuki and may not be covered under the New Vehicle Limited Warranty or the Emission Control System Warranty.

NOTE:

- *To help minimize air pollution, Suzuki recommends that you use oxygenated fuels.*
- *Be sure that any oxygenated fuel you use has recommended octane ratings.*
- *If you are not satisfied with the drivability of your motorcycle when you are using an oxygenated fuel, or if engine pinging is experienced, substitute another brand as there are differences between brands.*

NOTICE

Spilled gasoline containing alcohol can damage the painted surfaces of your motorcycle.

Be careful not to spill any fuel when filling the fuel tank. Wipe spilled gasoline up immediately.

NOTICE

Do not use leaded gasoline.

Use of leaded gasoline causes the catalytic converter to malfunction.

ENGINE OIL

Use Suzuki genuine engine oil or equivalent. If Suzuki genuine engine oil is not available, select a proper engine oil according to the following guideline.

Oil quality is a major contributor to your engine's performance and life. Always select good quality engine oil. Use oil with an API (American Petroleum Institute) classification of SG, SH, SJ or SL with a JASO classification of MA.

SAE	API	JASO
10W-40	SG, SH, SJ or SL	MA

API: American Petroleum Institute

JASO: Japanese Automobile Standards Organization

SAE Engine Oil Viscosity

Suzuki recommends the use of SAE 10W-40 engine oil. If SAE 10W-40 engine oil is not available, select an alternative according to the following chart.

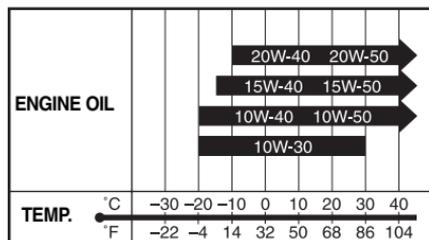

JASO T903

The JASO T903 standard is an index to select engine oils for 4-stroke motorcycle and ATV engines. Motorcycle and ATV engines lubricate clutch and transmission gears with engine oil. JASO T903 specifies performance requirements for motorcycle and ATV clutches and transmissions.

There are two classes, MA and MB. The oil container shows the classification as follows.

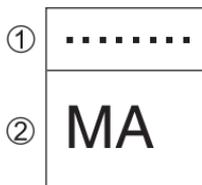

① Code number of oil sales company

② Oil classification

Energy Conserving

Suzuki does not recommend the use of “ENERGY CONSERVING” or “RESOURCE CONSERVING” oils. Some engine oils which have an API classification of SH, SJ or SL have an “ENERGY CONSERVING” indication in the API classification donut mark. These oils can affect engine life and clutch performance.

API SG, SH, SJ or SL



Recommended

API SH, SJ or SL



Not recommended

ENGINE COOLANT SOLUTION

Use “SUZUKI SUPER LONG LIFE COOLANT” or “SUZUKI LONG LIFE COOLANT”. If “SUZUKI SUPER LONG LIFE COOLANT” and “SUZUKI LONG LIFE COOLANT” are not available, use a glycol-based anti-freeze compatible with an aluminum radiator mixed with distilled water only at the ratio of 50:50.

WARNING

Engine coolant is harmful or fatal if swallowed or inhaled. Solution can be poisonous to animals.

Do not drink antifreeze or coolant solution. If swallowed, do not induce vomiting. Immediately contact a poison control center or a physician. Avoid inhaling mist or hot vapors; if inhaled, remove to fresh air. If coolant gets in eyes, flush eyes with water and seek medical attention. Wash thoroughly after handling. Keep out of the reach of children and animals.

NOTICE

Spilled engine coolant can damage the painted surfaces of your motorcycle.

Be careful not to spill any fluid when filling the radiator. Wipe spilled engine coolant up immediately.

Engine coolant

Engine coolant performs as a rust inhibitor and water pump lubricant as well as an anti-freeze solution. Therefore engine coolant should be used at all times even though the atmospheric temperature in your area does not go down to the freezing point.

SUZUKI SUPER LONG LIFE COOLANT (Blue)

“SUZUKI SUPER LONG LIFE COOLANT” is pre-mixed to the proper ratio. Add only “SUZUKI SUPER LONG LIFE COOLANT” if coolant level drops. It is not necessary to dilute “SUZUKI SUPER LONG LIFE COOLANT” when replacing coolant.

SUZUKI LONG LIFE COOLANT (Green)

Water for mixing

Use distilled water only. Water other than distilled water can corrode and clog the aluminium radiator.

Required amount of water/coolant

Solution capacity (total):

2800 ml (6.0/5.0 US/Imp. qt)

50%	Water	1400 ml (3.0/2.5 US/Imp. qt)
	Coolant	1400 ml (3.0/2.5 US/Imp. qt)

NOTE: This 50% mixture will protect the cooling system from freezing at temperatures above -31°C (-24°F). If the motorcycle is to be exposed to temperature below -31°C (-24°F), this mixing ratio should be increased up to 55% ($-40^{\circ}\text{C}/-40^{\circ}\text{F}$) or 60% ($-55^{\circ}\text{C}/-67^{\circ}\text{F}$) coolant. The mixing ratio should not exceed 60% coolant.

BREAK-IN (RUNNING-IN) AND INSPECTION BEFORE RIDING

MAXIMUM ENGINE SPEED RECOMMENDATION	4-2
VARY THE ENGINE SPEED	4-2
BREAKING IN THE NEW TIRES	4-2
AVOID CONSTANT LOW SPEED	4-2
ALLOW THE ENGINE OIL TO CIRCULATE BEFORE RIDING	4-3
OBSERVE YOUR FIRST AND MOST CRITICAL SERVICE	4-3
INSPECTION BEFORE RIDING	4-3

BREAK-IN (RUNNING-IN) AND INSPECTION BEFORE RIDING

Previous sections explain how important proper break-in is to achieving maximum life and performance from your new Suzuki. The following guidelines explain proper break-in procedures.

MAXIMUM ENGINE SPEED RECOMMENDATION

This table shows the maximum recommended engine speed during the break-in period.

Initial	800 km (500 miles)	Below 5700 rpm
Up to	1600 km (1000 miles)	Below 8600 rpm
Over	1600 km (1000 miles)	Below 11500 rpm

VARY THE ENGINE SPEED

The engine speed should be varied and not held at a constant speed. This allows the parts to be "loaded" with pressure, and then unloaded, allowing the parts to cool. This aids the mating process of the parts. It is essential that some stress be placed on the engine components during break-in to ensure this mating process. Do not, though, apply excessive load on the engine.

BREAKING IN THE NEW TIRES

New tires need proper break-in to assure maximum performance, just as the engine does. Wear in the tread surface by gradually increasing your cornering lean angles over the first 160 km (100 miles) before attempting maximum performance. Avoid hard acceleration, hard cornering, and hard braking for the first 160 km (100 miles).

WARNING

Failure to perform break-in of the tires could cause tire slip and loss of control.

Use extra care when riding on new tires. Perform proper break-in of the tires as described in this section and avoid hard acceleration, hard cornering, and hard braking for the first 160 km (100 miles).

AVOID CONSTANT LOW SPEED

Operating the engine at constant low speed (light load) can cause parts to glaze and not seat in. Allow the engine to accelerate freely through the gears, without exceeding the recommended maximum limits. Do not, however, use full throttle for the first 1600 km (1000 miles).

ALLOW THE ENGINE OIL TO CIRCULATE BEFORE RIDING

Allow sufficient idling time after warm or cold engine start up before applying load or revving the engine. This allows time for the lubricating oil to reach all critical engine components.

OBSERVE YOUR FIRST AND MOST CRITICAL SERVICE

The initial service (1000 km maintenance) is the most important service your motorcycle will receive. During break-in operation, all of the engine components will have mated together and seated. Maintenance required as part of the initial service includes correction of all adjustments, tightening of all fasteners and replacement of dirty oil. Timely performance of this service will help make sure you get the best service life and performance from the engine.

NOTE: The 1000 km (600 miles) service should be performed as outlined in the INSPECTION AND MAINTENANCE section of this Owner's Manual. Pay particular attention to the CAUTION and WARNING messages in that section.

INSPECTION BEFORE RIDING

WARNING

Failure to inspect your motorcycle before riding and to properly maintain your motorcycle increases the chances of an accident or equipment damage.

Always inspect your motorcycle each time you use it to make sure it is in safe operating condition. Refer to the **INSPECTION AND MAINTENANCE** section in this owner's manual.

WARNING

If you operate this motorcycle with improper tires or improper or uneven tire pressure, you may lose control of the motorcycle. This will increase your risk of an accident.

Always use tires of the size and type specified in this owner's manual. Always maintain proper tire pressure as described in the **INSPECTION AND MAINTENANCE** section.

Before riding the motorcycle, be sure to check the following items. Never underestimate the importance of these checks. Perform all of them before riding the motorcycle.

WARNING

Checking maintenance items when the engine is running can be hazardous. You could be severely injured if your hands or clothing get caught in moving engine parts.

Shut the engine off when performing maintenance checks, except when checking the lights, engine stop switch, and throttle.

WHAT TO CHECK	CHECK FOR:
Steering	<ul style="list-style-type: none"> • Smoothness • No restriction of movement • No play or looseness
Throttle ( 6-30)	<ul style="list-style-type: none"> • Correct play in the throttle cable • Smooth operation and positive return of the throttle grip to the closed position
Clutch ( 6-31)	<ul style="list-style-type: none"> • Correct lever play • Smooth and progressive action
Brakes ( 2-30, 2-33, 6-38)	<ul style="list-style-type: none"> • Proper pedal and lever operation • Fluid level in the reservoirs to be above "LOWER" line • Correct pedal and lever play • No "sponginess" • No fluid leakage • Brake pads not to be worn down to the limit line
Suspension ( 2-38)	Smooth movement
Fuel ( 2-18)	Enough fuel for the planned distance of operation

Drive chain ( 6-34)	<ul style="list-style-type: none"> • Correct tension or slack • Adequate lubrication • No excessive wear or damage
Tires ( 6-42)	<ul style="list-style-type: none"> • Correct pressure • Adequate tread depth • No cracks or cuts
Engine oil ( 6-24)	Correct level
Cooling system ( 6-32)	<ul style="list-style-type: none"> • Proper coolant level • No coolant leakage
Lighting ( 2-7, 2-10, 2-24)	Operation of all lights and indicators
Horn ( 2-25)	Correct function
Engine stop switch ( 2-29)	Correct function
Side stand/ Ignition interlock system ( 6-46)	Proper operation
Windshield (GSX-S1000F/FA) ( 8-5)	Good visibility

RIDING TIPS

STARTING THE ENGINE	5-2
STARTING OFF	5-3
USING THE TRANSMISSION	5-4
RIDING ON HILLS	5-5
STOPPING AND PARKING	5-6

RIDING TIPS

STARTING THE ENGINE

Before attempting to start the engine, make sure:

- The transmission is in neutral.
- The engine stop switch is in the "O" position.

NOTE: When the electric starter switch is pushed, the starter motor will continue turning for about 1.5 seconds even when you release your hand from the switch. After elapsing about 1.5 second, or when the engine is started, the starter motor will stop automatically.

NOTE: This motorcycle is equipped with an interlock system for the ignition circuit and the starter circuit.

The engine can only be started if:

- The transmission is in neutral, or
- The transmission is in gear, the side stand is fully up and the clutch is disengaged.

NOTE: The fuel supply system stops the engine when the motorcycle is overturned. Turn off the ignition switch before restarting the engine.

When the Engine is Cold:

1. Close the throttle completely and push the electric starter switch.
2. After the engine starts, let the engine run until the engine sufficiently warms up.

When a Cold Engine is Hard to Start:

1. Open the throttle approximately 1/8 turn and push the electric starter switch.
2. After the engine starts, let the engine run until the engine sufficiently warms up.

When the Engine is Warm:

Close the throttle completely and push the electric starter switch.

When a Warm Engine is Hard to Start:

Open the throttle approximately 1/8 turn and push the electric starter switch.

WARNING

Exhaust gas contains carbon monoxide, a dangerous gas that is difficult to detect because it is colorless and odorless. Breathing carbon monoxide can cause death or severe injury.

Never start the engine or let it run indoors or where there is little or no ventilation.

NOTICE

Running the engine too long without riding may cause the engine to overheat. Overheating can result in damage to internal engine components and discoloration of exhaust pipes.

Shut the engine off if you cannot begin your ride promptly.

STARTING OFF

WARNING

Riding at excessive speeds increases your chances of losing control of the motorcycle, which can result in an accident.

Always ride at a speed that is proper for the terrain, visibility and operating conditions, and your skills and experience.

WARNING

If you remove even one hand or foot from the motorcycle, you can reduce your ability to control the motorcycle. This could cause you to lose your balance and fall off the motorcycle. If you remove a foot from a footrest, your foot or leg may come in contact with the rear wheels. This could injure you or cause an accident.

Always keep both hands on the handlebars and both feet on the footrests of your motorcycle during operation.

WARNING

Sudden side winds, which can occur when being passed by larger vehicles, at tunnel exits or in hilly areas, can cause you to lose control of the motorcycle.

Reduce your speed and be alert to the possibility of sudden side winds.

After moving the side stand to the fully up position, squeeze the clutch lever and pause momentarily. Engage first gear by depressing the gear shift lever downward. Twist the throttle grip toward you and at the same time release the clutch lever gently and smoothly. As the clutch engages, the motorcycle will start moving forward. To shift to the next higher gear, accelerate gently, then close the throttle and squeeze the clutch lever simultaneously. Lift the gear shift lever upward to select the next gear, release the clutch lever and open the throttle again. Select higher gears in this manner until top gear is reached.

NOTE: This motorcycle is equipped with a side stand/ignition interlock system. If you shift the transmission into gear when the side stand is down, the engine will stop running.

USING THE TRANSMISSION

The transmission is provided to keep the engine operating smoothly in its normal operating speed range. The gear ratios have been carefully chosen to meet the characteristics of the engine. The rider should always select the most suitable gear for the prevailing conditions. Never slip the clutch to control road speed, but rather downshift to allow the engine to run within its normal operational range.

(Canada)

The table below shows the approximate speed range for each gear.

Shifting up schedule

Gear position	km/h	miles/h
1st → 2nd	20	12
2nd → 3rd	30	19
3rd → 4th	40	25
4th → 5th	50	31
5th → 6th	60	37

Shifting down schedule

Gear position	km/h	miles/h
6th → 5th	50	31
5th → 4th	40	25
4th → 3rd	30	19

Disengage the clutch when the motorcycle speed drops below 20 km/h (12 miles/h).

WARNING

Downshifting when engine speed is too high can:

- cause the rear wheel to skid and lose traction due to increased engine braking, resulting in an accident; or
- force the engine to overrev in the lower gear, resulting in engine damage.

Reduce speed before downshifting.

WARNING

Downshifting while the motorcycle is leaned over in a corner may cause rear wheel skid and loss of control.

Reduce your speed and downshift before entering a corner.

NOTICE

Revvng the engine into the red zone can cause severe engine damage.

Never allow the engine to rev into the red zone in any gear.

NOTICE

Improper gearshift lever operation can damage the transmission.

- Do not rest your foot on the gearshift lever.
- Do not use force to shift gears.

RIDING ON HILLS

- When climbing steep hills, the motorcycle may begin to slow down and show lack of power. At this point you should shift to a lower gear so that the engine will again be operating in its normal power range. Shift rapidly to prevent the motorcycle from losing momentum.
- When descending a long, steep slope, use the engine compression to assist the brakes by shifting to a lower gear. Continuous brake application can overheat the brakes and reduce their effectiveness.
- Be careful, however, not to allow the engine to over rev.

STOPPING AND PARKING

Anti-lock Brake System (ABS) (GSX-S1000A/FA)

This model is equipped with an Anti-lock Brake System (ABS) designed to help prevent wheel lock up during hard braking or during braking on slippery surfaces while riding in a straight line.

The ABS will operate whenever it senses that the wheels are locking up. You may feel the brake lever and/or the brake pedal pulsate lightly while the ABS is operating.

Even though ABS helps prevent wheel lock-up, you must still be careful when braking in curves. Hard braking while turning could cause wheel skidding and loss of control, whether or not your motorcycle is equipped with ABS. Having ABS does not mean you can take unnecessary risks. ABS will not compensate for poor judgment, incorrect braking techniques, or not slowing down over bad roads or in poor weather conditions.

You must still ride sensibly and alertly.

On regular paved roads, some riders may be able to obtain slightly shorter stopping distances with conventional brake systems than with ABS.

NOTE: In some situations, a motorcycle with ABS may require a longer stopping distance to stop on loose or uneven surfaces than an equivalent motorcycle without ABS.

WARNING

Inexperienced riders tend to underutilize the front brake. This can cause excessive stopping distance and lead to a collision. Using only the front or rear brake can cause skidding and loss of control.

Apply both brakes evenly and at the same time.

WARNING

Braking while turning the motorcycle can be hazardous, whether or not your motorcycle is equipped with ABS. ABS can not control wheel side-slips that occur when you brake hard while turning and the side-slips could cause loss of control.

Slow down sufficiently in a straight line before you begin to turn and avoid other than slight braking while turning.

WARNING

Failure to use good judgment with ABS can be hazardous. ABS cannot make up for bad road conditions, bad judgement, or improper operation of the brakes.

Remember that ABS will not compensate for poor judgment, incorrect braking techniques, or the need to slow down over bad roads or in poor weather conditions. Use good judgment and do not ride faster than conditions will safely allow.

How the ABS Works (GSX-S1000A/FA)

ABS works by electronically controlling braking pressure. A computer monitors wheel rotation speed. If the computer detects that a braked wheel has slowed suddenly, indicating a skidding situation, the computer will reduce braking pressure to prevent that wheel from locking up. ABS works automatically, so you do not need any special braking technique. Just apply the front and rear brakes, as forcefully as necessary for the situation, without pumping either one. It is normal for the brake lever/pedal to pulsate while the ABS is operating.

Non-recommended tires can affect wheel speed and may confuse the computer.

ABS does not work at very low speed, less than about 5 km/h (3 mph), and does not work with a discharged battery.

Stopping and Parking

1. Twist the throttle grip away from yourself to close the throttle completely.
2. Apply the front and rear brakes evenly and at the same time.
3. Downshift through the gears as road speed decreases.
4. Select neutral with the clutch lever squeezed toward the grip (disengaged position) when the motorcycle is almost completely stopped. The neutral position can be confirmed by observing the neutral indicator light.

WARNING

Inexperienced riders tend to underutilize the front brake. This can cause excessive stopping distance and lead to a collision. Using only the front or rear brake can cause skidding and loss of control.

Apply both brakes evenly and at the same time.

WARNING

Hard braking while turning may cause wheel skid and loss of control.

Brake before you begin to turn.

WARNING

Hard braking on wet, loose, rough, or other slippery surfaces can cause wheel skid and loss of control.

Brake lightly and with care on slippery or irregular surfaces.

WARNING

Following another vehicle too closely can lead to a collision. As vehicle speeds increase, stopping distance increases progressively.

Always maintain a safe stopping distance between you and the vehicle in front of you.

NOTICE

Holding the motorcycle stopped with throttle and clutch lever operation on inclines can damage the motorcycle's clutch.

Use the brakes when stopping the motorcycle on inclines.

5. Park the motorcycle on a firm, flat surface where it will not fall over.

CAUTION

A hot muffler can cause severe burns. The muffler will be hot enough to cause burns for some time after stopping the engine.

Park the motorcycle where pedestrians or children are not likely to touch the muffler.

NOTE: If the motorcycle is to be parked on the side stand on a slight slope, the front end of the motorcycle should face "up" the incline to avoid rolling forward off the side stand. You may leave the motorcycle in 1st gear to help prevent it from rolling off the side stand. Shift to neutral before starting the engine.

6. Turn the ignition key to the "OFF" position.
7. Turn the handlebars all the way to the left and lock the steering for security.
8. Remove the ignition key.

NOTE: If an optional anti-theft lock such as a U-shape lock, brake disk lock or chain is used to avoid theft, be sure to remove the anti-theft lock before moving the motorcycle.



INSPECTION AND MAINTENANCE

MAINTENANCE SCHEDULE	6-2
TOOLS	6-6
METER PANEL REMOVAL AND INSTALLATION (GSX-S1000F/FA)	6-6
FAIRING REMOVAL AND INSTALLATION (GSX-S1000F/FA)	6-10
FUEL TANK LIFT	6-15
LUBRICATION POINTS	6-18
BATTERY	6-19
AIR CLEANER	6-21
FUEL HOSE	6-24
ENGINE OIL	6-24
ENGINE IDLE SPEED INSPECTION	6-29
THROTTLE CABLE ADJUSTMENT	6-30
CLUTCH	6-31
COOLANT	6-32
DRIVE CHAIN	6-34
BRAKES	6-38
TIRES	6-42
SIDE STAND/IGNITION INTERLOCK SYSTEM	6-46
FRONT WHEEL REMOVAL	6-47
REAR WHEEL REMOVAL	6-50
LIGHT BULB REPLACEMENT	6-52
FUSES	6-58
HANDLEBAR FITTING	6-60
CATALYTIC CONVERTER	6-61

INSPECTION AND MAINTENANCE

MAINTENANCE SCHEDULE

The chart indicates the intervals between periodic services in miles, kilometers and months. At the end of each interval, be sure to inspect, check, lubricate and service as instructed. If your motorcycle is used under high stress conditions such as continuous full throttle operation, or is operated in a dusty climate, certain services should be performed more often to ensure reliability of the machine as explained in the maintenance section. Your Suzuki dealer can provide you with further guidelines. Steering components, suspensions and wheel components are key items and require very special and careful servicing. For maximum safety we suggest that you have these items inspected and serviced by your authorized Suzuki dealer or a qualified service mechanic.

WARNING

Improper maintenance or failure to perform recommended maintenance can lead to an accident.

Keep your motorcycle in good condition. Ask your Suzuki dealer or a qualified mechanic to perform the maintenance items marked with an asterisk (*). You may perform the unmarked maintenance items by referring to the instructions in this section, if you have mechanical experience. If you are not sure how to do any of the jobs, ask your Suzuki dealer to do the maintenance.

WARNING

Exhaust gas contains carbon monoxide, a dangerous gas that is difficult to detect because it is colorless and odorless. Breathing carbon monoxide can cause death or severe injury.

Never start the engine or let it run indoors or where there is little or no ventilation.

NOTICE

Servicing electric parts with the ignition switch in the "ON" position can damage the electric parts when the electric circuit is shorted.

Turn off the ignition switch before servicing the electric parts to avoid short-circuit damage.

NOTICE

Poorly-made replacement parts can cause your motorcycle to wear more quickly and may shorten its useful life.

When replacing parts on your vehicle, use only genuine Suzuki replacement parts or their equivalent.

NOTE: The MAINTENANCE CHART specified the minimum requirements for maintenance. If you use your motorcycle under severe conditions, perform maintenance more often than shown in the chart. If you have any questions regarding maintenance intervals, consult your Suzuki dealer or a qualified mechanic.

MAINTENANCE CHART

Interval: This interval should be judged by number of months or odometer reading, whichever comes first.

Item	Interval	months	2	12	24	36	48
		km	1000	6000	12000	18000	24000
		miles	600	4000	7500	11000	14500
Air cleaner element (🔧 6-21)		–	I	I	R	I	
* Exhaust pipe bolts and muffler bolts		T	–	T	–	T	
* Exhaust control valve		I	–	I	–	I	
* Valve clearance		–	–	–	–	I	
* Spark plugs		–	I	R	I	R	
Fuel hose (🔧 6-24)		–	I	I	I	I	
Engine oil (🔧 6-24)		R	R	R	R	R	
Engine oil filter (🔧 6-24)		R	–	–	R	–	
Throttle cable play (🔧 6-30)		I	I	I	I	I	
* PAIR (air supply) system		–	–	I	–	I	
* Throttle valve synchronization		–	–	I	–	I	
* Engine coolant (🔧 6-32)	"SUZUKI SUPER LONG LIFE COOLANT" (Blue)	Replace every 4 years or 48000 km (29000 miles)					
	"SUZUKI LONG LIFE COOLANT" (Green) or an engine coolant other than "SUZUKI SUPER LONG LIFE COOLANT" (Blue)	–	–	R	–	R	
Radiator hose (🔧 6-33)		–	I	I	I	I	
Clutch cable play (🔧 6-31)		–	I	I	I	I	
Drive chain (🔧 6-34)		I	I	I	I	I	
		Clean and lubricate every 1000 km (600 miles)					
* Brakes (🔧 6-38)		I	I	I	I	I	
Brake fluid (🔧 6-38)		–	I	I	I	I	
		*Replace every 2 years					
Brake hose (🔧 6-38)		–	I	I	I	I	
		*Replace every 4 years					
Tires (🔧 6-42)		–	I	I	I	I	
* Steering		I	–	I	–	I	
* Front forks (🔧 2-38)		–	–	I	–	I	
* Rear suspension (🔧 2-41)		–	–	I	–	I	
* Chassis bolts and nuts		T	T	T	T	T	
Lubrication (🔧 6-18)		Lubricate every 1000 km (600 miles)					

NOTE: I= Inspect and clean, adjust, replace or lubricate as necessary, R= Replace, T= Tighten

For Europe and Oceania countries

Item	Interval	months	2	12	24	36	48
		km	1000	12000	24000	36000	48000
		miles	600	7500	15000	22500	30000
Air cleaner element (🔧 6-21)		–	I	I	R	I	
* Exhaust pipe bolts and muffler bolts		T	T	T	T	T	
* Exhaust control valve		I	–	I	–	I	
* Valve clearance		Inspect every 24000 km (15000 miles)					
* Spark plugs		–	R	R	R	R	R
Fuel hose (🔧 6-24)		–	I	I	I	I	I
Engine oil (🔧 6-24)		R	R	R	R	R	R
Engine oil filter (🔧 6-24)		R	–	R	–	R	
Throttle cable play (🔧 6-30)		I	I	I	I	I	
* PAIR (air supply) system		–	–	I	–	I	
* Throttle valve synchronization		–	I	I	I	I	
* Engine coolant (🔧 6-32)	"SUZUKI SUPER LONG LIFE COOLANT" (Blue)	–	–	–	–	–	R
	"SUZUKI LONG LIFE COOLANT" (Green) or an engine coolant other than "SUZUKI SUPER LONG LIFE COOLANT" (Blue)	–	–	R	–	–	R
Radiator hose (🔧 6-33)		–	I	I	I	I	I
Clutch cable play (🔧 6-31)		–	I	I	I	I	I
Drive chain (🔧 6-34)		I	I	I	I	I	I
		Clean and lubricate every 1000 km (600 miles)					
* Brakes (🔧 6-38)		I	I	I	I	I	I
Brake fluid (🔧 6-38)		Inspect every year or 6000 km (4000 miles) * Replace every 2 years					
		–	I	I	I	I	I
Brake hose (🔧 6-38)		*Replace every 4 years					
		–	I	I	I	I	I
Tires (🔧 6-42)		–	I	I	I	I	I
* Steering		I	I	I	I	I	I
* Front forks (🔧 2-38)		–	I	I	I	I	I
* Rear suspension (🔧 2-41)		–	I	I	I	I	I
* Chassis bolts and nuts		T	T	T	T	T	T
Lubrication (🔧 6-18)		Lubricate every 1000 km (600 miles)					

NOTE: I and Inspect= Inspect and clean, adjust, replace or lubricate as necessary; R= Replace; T= Tighten

TOOLS

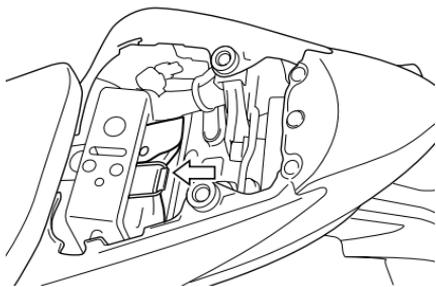

A tool kit is supplied and located under the rear seat.

METER PANEL REMOVAL AND INSTALLATION (GSX-S1000F/FA)

REMOVAL

1. Place the motorcycle on the side stand.

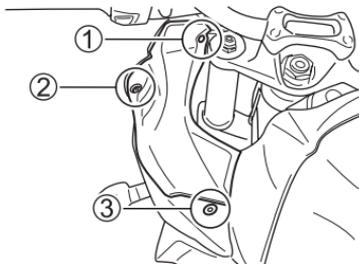

2. Remove the fastener ①, bolt ② and bolt ③ of the right and left meter panels.

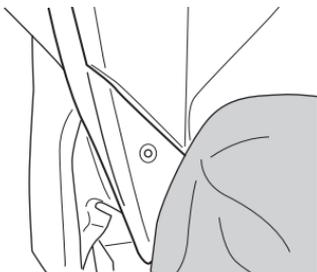

3. Place a cloth between the meter panel and the fuel tank to prevent damage to the fuel tank.

NOTICE

When removing the meter panel, the bolt mounting part on the rear end may cause damage to the fuel tank and fairing.

When removing the meter panel, use a cloth to prevent scratches, and carefully remove the panel using the following procedure.

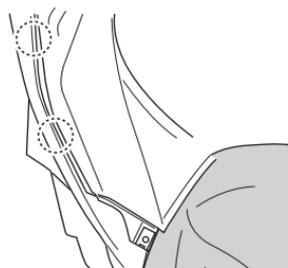
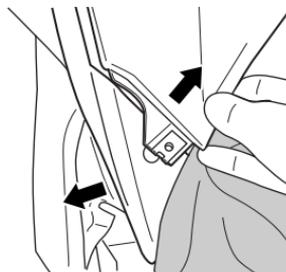

4. Remove the meter panel starting from the rear end portion. Lightly press the fairing toward the outside of the motorcycle (in the direction of the arrow), and lift the mating surface on the rear end of the meter panel above the fairing. Disengage the hook (marked with a dotted circle) on the side of the meter panel.

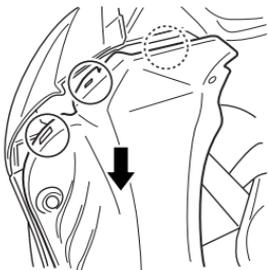

5. Pull out the meter panel toward the rear end of the motorcycle (in the direction of the arrow). In doing so, the hooks (marked with a dotted circle) also come off.

INSTALLATION

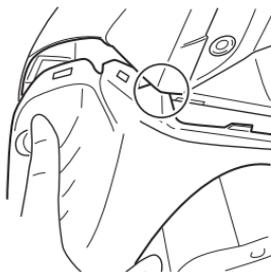

1. Install the meter panel starting from the front end portion. Lightly insert the front end of the meter panel into the central end face of the fairing (place marked with a circle) as shown in the illustration.

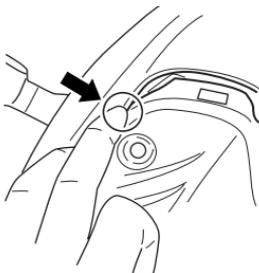

2. As the outer side of the front end of the meter panel bulges, lightly insert the place marked with a circle as well while aligning it with the hooks.

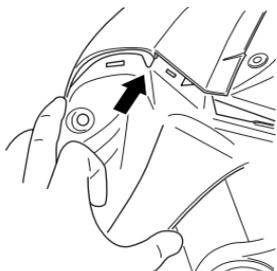

3. Push the front end of the meter panel in the direction of the arrow.

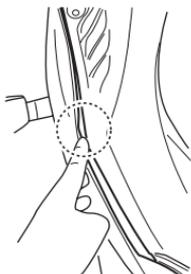

4. Fit the hooks (marked with a dotted circle) on the side of the meter panel.

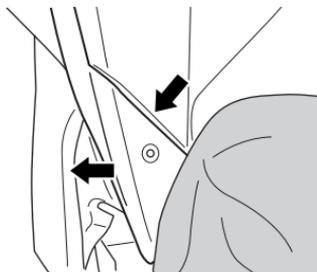

5. Lightly press the fairing toward outside of the motorcycle (in the direction of the arrow), and insert the mating surface on the rear end of the meter panel under the fairing. Check that the hooks on the outer side of the meter panel are securely engaged.

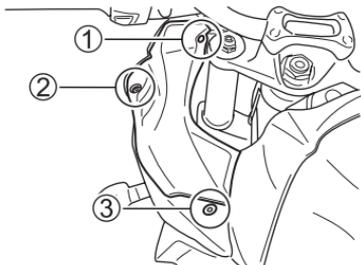

6. Tighten the fastener ① and bolt ② on the front end of the meter panel, and tighten the bolt ③ on the rear end of the meter panel in the numbered order.

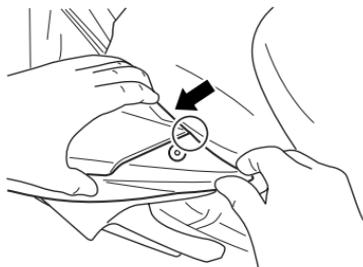

NOTE: When tightening the bolt ③ on the rear end of the meter panel, the mating condition around the meter panel can be improved by performing the work while pushing the bottom of the meter panel and the end face of the fairing (place marked with a circle) in the direction of the arrow so that they are aligned.

FAIRING REMOVAL AND INSTALLATION (GSX-S1000F/FA)

REMOVAL

1. Place the motorcycle on the side stand.

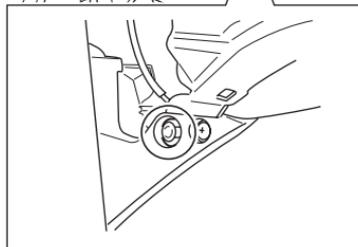
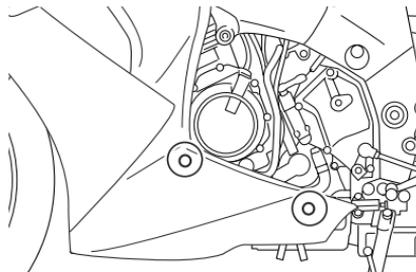

2. Remove the right and left fairing bolts and inner fairing fasteners.

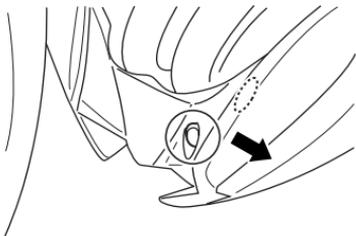

3. Remove the under fairing fastener. Unhook the hooks located at the lower part of the left-side fairing.
4. Remove the right and left meter panels by referring to the METER PANEL REMOVAL AND INSTALLATION section.

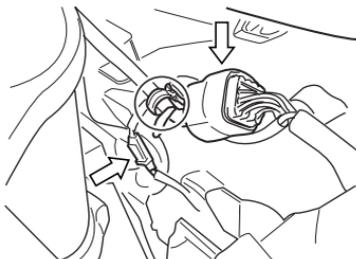

Right

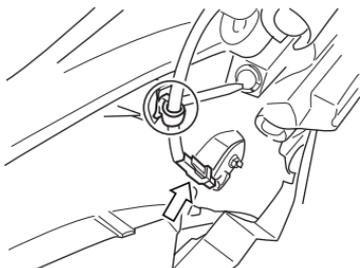

Left

5. Disengage the turn signal and meter wire harnesses from the clamp. Disconnect the right and left turn signal connectors and the right side meter coupler.

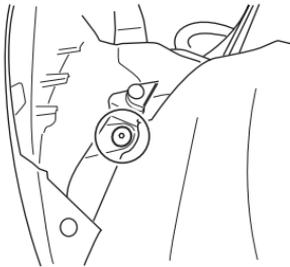
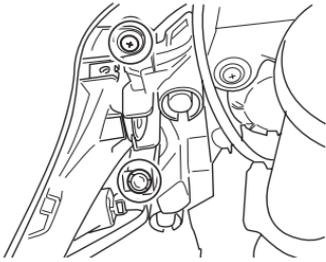

6. Remove the bolts, screws, and fasteners on the inner side of the right and left fairings.



7. Remove the right and left fairings one by one. Unhook the hook on the inner side of the fairing.

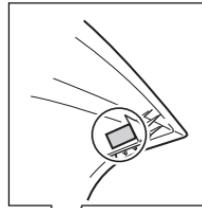

8. Unhook the hook, which is fixed on the radiator, from the bottom side of the fairing, and carefully pull out the fairing.

INSTALLATION

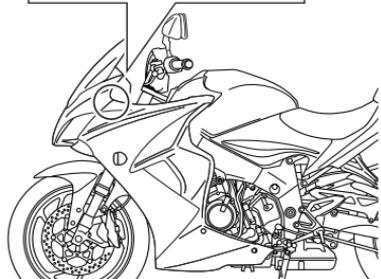
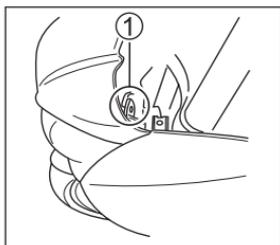

1. Align the top part ① of the fairing (Removal procedure 6. Screw Section).

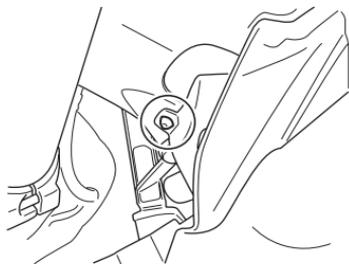

NOTE: Be careful not to allow the inner side of the fairing to touch the radiator or frame. Otherwise, the cushion on the inner side may come off.

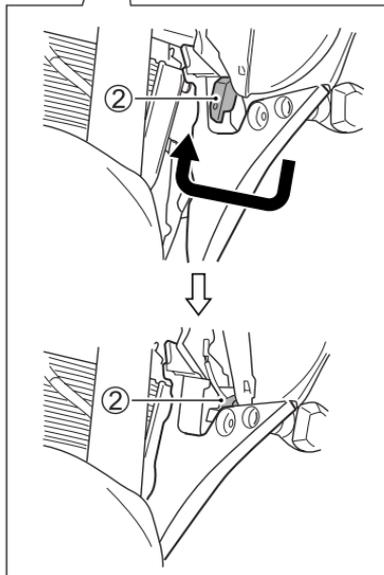
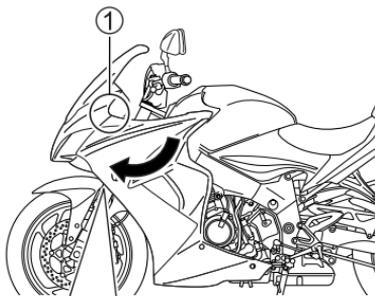

2. Move the fairing forward using the top part ① of the fairing as a rotational axis, and fit the headlight tightening seating surface ② into the notch on the inner side of the fairing.

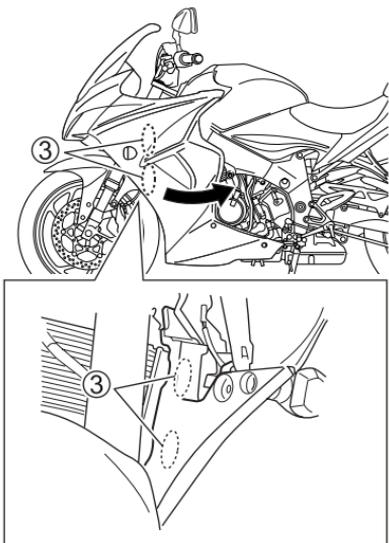

3. Lightly press the fairing toward the inner side of the motorcycle, and slide it backward to insert it into the radiator hook ③.

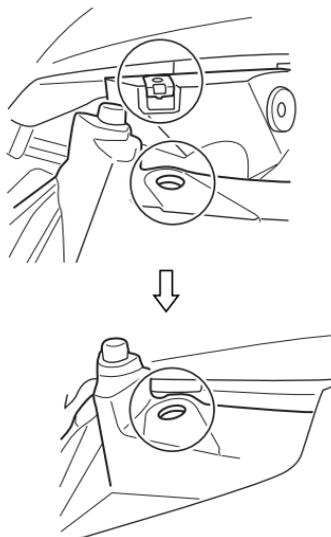

NOTE: When the insertion of the radiator hook ③ is completed, the inner side of the fairing (Removal procedure 6. Bolt Tightening Section) can be aligned.

4. After completing the insertion of the radiator hook ③, fix the fairing in the reverse order of the removal procedure.

FUEL TANK LIFT

1. Place the motorcycle on the side stand.
2. Remove the seat by referring to the SEAT LOCK AND HELMET HOLDERS section.

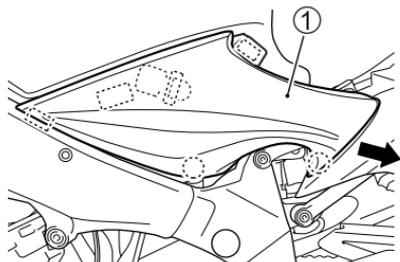

3. The right and left side frame covers have fasteners behind the cover at the places marked with rectangles. Pull up the side frame covers ① to unfasten the fasteners. The side frame covers have hooks behind the places marked with circles. Move the side frame cover ① backward to slip off the hook.

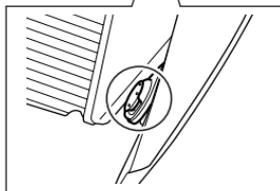
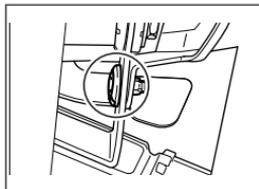
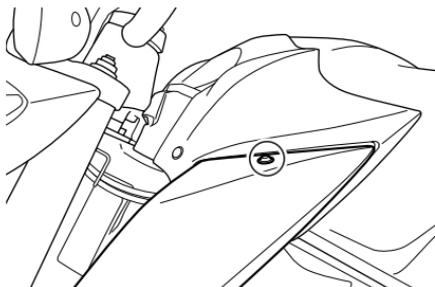

(GSX-S1000/A)

4. Remove the right and left bolts and fasteners.

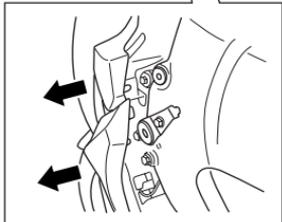
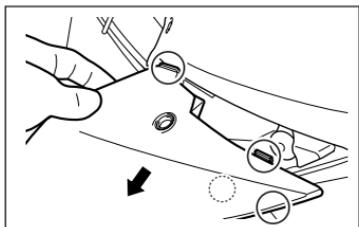

(GSX-S1000/A)

5. Unhook the hooks and remove the right and left frame body covers ② by sliding the covers forward.

(GSX-S1000F/FA)

Remove the meter panel and fairings by referring to the METER PANEL REMOVAL AND INSTALLATION, FAIRING REMOVAL AND INSTALLATION section.

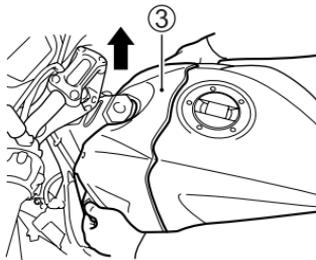
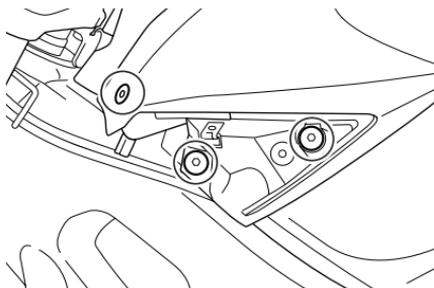

6. Remove the right and left bolts and fasteners. Pull up the fuel tank upper cover ③.

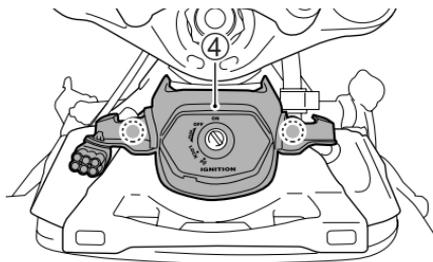

7. Unhook the hooks and remove the fuel tank lower cover assembly ④.

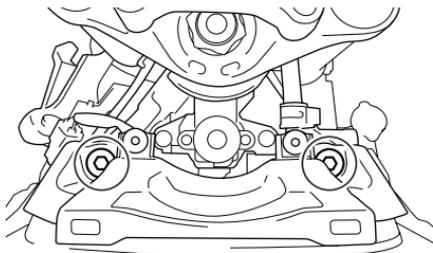

8. Remove the fuel tank fitting bolts.



9. Lift the front end of the fuel tank and prop it up as shown above. Put the circle end of the prop stay on to the steering stem nut.

NOTE: A prop stay is available at your Suzuki dealer. The prop stay part number is 44560-23H00.

▲ WARNING

If you lift up the fuel tank when it is full, fuel can seep out from the fuel tank cap, creating a fire hazard.

Reduce the fuel level to less than 1/4 full before lifting up the fuel tank. The fuel indicator on the instrument panel will blink or remain lit when the fuel level is less than 1/4 full.

LUBRICATION POINTS

Proper lubrication is important for smooth operation and long life of each working part of your motorcycle and also for safe riding. It is a good practice to lubricate the motorcycle after a long rough ride and after getting it wet in the rain or after washing it. Major lubrication points are indicated below.

NOTICE

Lubricating electrical switches can damage the switches.

Do not apply grease and oil to electrical switches.

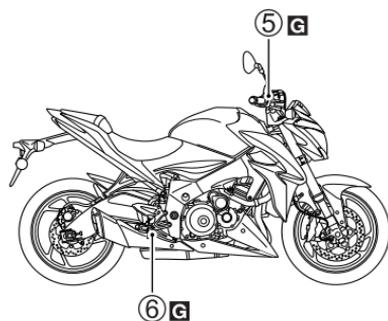
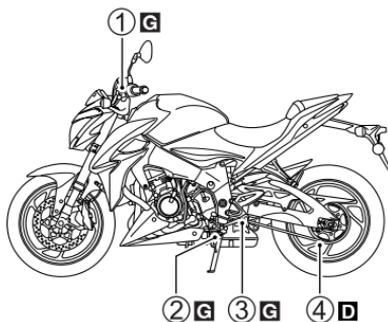

- G** Grease
- D** Drive chain lubricant

- ① Clutch lever pivot
- ② Side stand pivot and spring hook
- ③ Gearshift lever pivot and footrest pivot
- ④ Drive chain
- ⑤ Brake lever pivot
- ⑥ Brake pedal pivot and footrest pivot

BATTERY

The battery is a sealed type battery and requires no maintenance. Have your dealer check the battery's state of charge periodically.

The standard charging rate is $1.2A \times 5$ to 10 hours and the maximum rate is $5.0A \times 1$ hour. Never exceed the maximum charging rate.

WARNING

Battery posts, terminals, and related accessories contain lead and lead compounds. Lead is harmful to your health if it gets into your blood stream.

Wash hands after handling any parts containing lead.

WARNING

Diluted sulfuric acid from the battery can cause blindness or severe burns.

When working near the battery, use proper eye protection and gloves. Flush eyes or body with ample water and get medical care immediately if you suffer injury. Keep batteries out of reach of children.

WARNING

Batteries produce flammable hydrogen gas which can explode if exposed to flames or sparks.

Keep flames and sparks away from the battery. Never smoke when working near the battery.

NOTICE

Exceeding the maximum charging rate for the battery can shorten its life.

Never exceed the maximum charging rate for the battery.

WARNING

Wiping the battery with a dry cloth can cause a static electricity spark, which can start a fire.

Wipe the battery with a damp cloth to avoid static electricity build up.

BATTERY REMOVAL

To remove the battery, follow the procedure below:

1. Place the motorcycle on the side stand.
2. Remove the front seat by referring to the SEAT LOCK AND HELMET HOLDERS section.

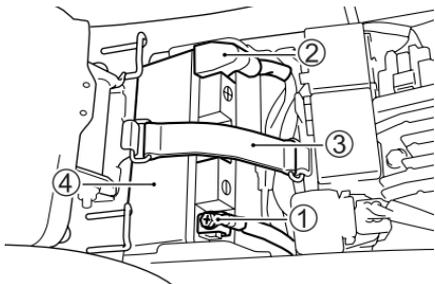

3. Disconnect the negative (-) terminal ①.
4. Remove the cap. Disconnect the positive (+) terminal ②.
5. Remove the band ③.
6. Remove the battery ④.

To install the battery:

1. Install the battery in the reverse order of removal.
2. Connect the battery terminals securely.

NOTICE

Reversing the battery lead wires can damage the charging system and the battery.

Always attach the red lead to the (+) positive terminal and the black (or black with white tracer) lead to the (-) negative terminal.

⚠ WARNING

Batteries contain toxic substances including sulfuric acid and lead. They could cause injury to humans or could damage the environment.

A used battery must be disposed of or recycled according to local law and must not be discarded with ordinary household waste. Make sure not to tip over the battery when you remove it from the vehicle. Otherwise, sulfuric acid could run out and you might be injured.

NOTE:

- Select the same type MF battery when replacing the battery.
- Recharge the battery once a month if the motorcycle is not used for a long time.



The crossed-out wheeled bin symbol (A) located on the battery label indicates that a used battery should be collected separately from ordinary household waste.

The chemical symbol of "Pb" (B) indicates the battery contains more than 0.004% lead.

By ensuring the used battery is disposed of or recycled correctly, you will help prevent potential negative consequences for the environment and human health, which could otherwise be caused by inappropriate waste handling of the battery. The recycling of materials will help to conserve natural resources. For more detailed information about disposing or recycling of the used battery, consult your Suzuki dealer.

AIR CLEANER

If the elements have become clogged with dust, intake resistance will increase with a resultant decrease in power output and an increase in fuel consumption. If you use your motorcycle under normal low-stress conditions, you should service the air cleaner at the intervals specified. If you ride in dusty, wet or muddy conditions, you will need to inspect the air cleaner element much more frequently. Use the following procedure to remove the element and inspect it.

WARNING

Operating the engine without the air cleaner element in place can be hazardous. A flame can spit back from the engine to the air intake box without the air cleaner element to stop it. Severe engine damage can also occur if dirt enters the engine due to running the engine without the air cleaner element.

Never run the engine without the air cleaner element in place.

NOTICE

Failure to inspect the air cleaner element frequently if the vehicle is used in dusty, wet, or muddy conditions can damage your motorcycle. The air cleaner element can become clogged under these conditions, and engine damage may result.

Always inspect the air cleaner element after riding in severe conditions. Replace the element as necessary. If water gets in the air cleaner case, immediately clean the element and the inside of the case.

REMOVAL

1. Lift the fuel tank by referring to the FUEL TANK LIFT section.

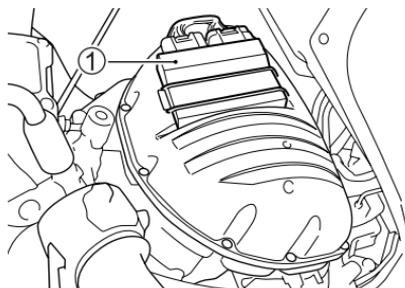

2. Remove the band. Remove the ECM ① from the air cleaner cap.

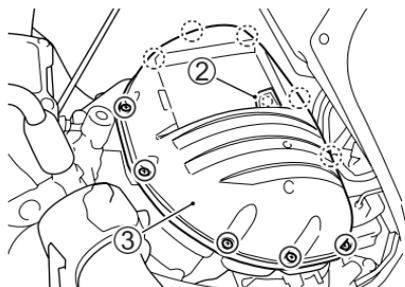

3. Remove the air cleaner cap plug ②. Remove the 11 screws. Remove the air cleaner cap ③.

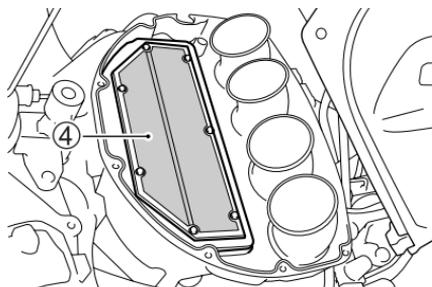

4. Remove the air cleaner element ④.

INSPECTION

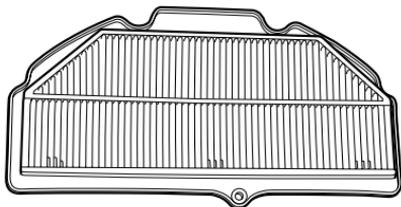

Inspect the air cleaner element condition. Replace the air cleaner element periodically.

NOTICE

Compressed air can damage the air cleaner element.

Do not blow the air cleaner element with compressed air.



Remove the plug and drain water and oil at the periodic maintenance interval. The air cleaner drain plug is located beneath the air cleaner box.

INSTALLATION

Reinstall the inspected element or new one in reverse order of removal. Be absolutely sure that the element is securely in position and is sealing properly.

NOTICE

A torn air cleaner element will allow dirt to enter the engine and can damage the engine.

Replace the air cleaner element with a new one if it is torn. Carefully examine the air cleaner element for tears during cleaning.

NOTICE

Failure to position the air cleaner element properly can allow dirt to bypass the air cleaner element. This will cause engine damage.

Be sure to properly install the air cleaner element.

NOTE: Be careful not to spray water on the air cleaner box when cleaning the motorcycle.

Reinstall the fuel tank.

NOTE: Check that the fuel tank drain hose and breather hose are not bent before reinstalling the fuel tank.

FUEL HOSE

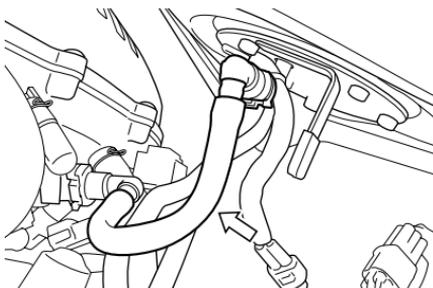

Inspect the fuel hose for damage and fuel leakage. If any defects are found, the fuel hose must be replaced.

NOTE: Be sure to check the fuel pump lead wire when reconnecting the fuel hose after disconnecting it.

ENGINE OIL

Long engine life depends much on the selection of a quality oil and the periodic changing of the oil. Daily oil level checks and periodic changes are two of the most important maintenance items to be performed.

ENGINE OIL LEVEL CHECK

Follow the procedure below to inspect the engine oil level.

1. Place the motorcycle on level ground on the side stand.
2. Start the engine and run it for three minutes.
3. Stop the engine and wait three minutes.

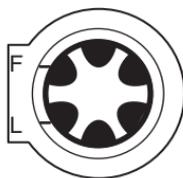

4. Hold the motorcycle vertically and inspect the engine oil level through the engine oil level inspection window on the right side of the engine.

NOTICE

Operating the motorcycle with too little or too much oil can damage the engine.

Place the motorcycle on level ground. Check the oil level with the engine oil inspection window before each use of the vehicle. Be sure the engine oil level is always above the "L" (low) line and not higher than the "F" (full) line.

ENGINE OIL AND FILTER CHANGE

Change the engine oil and oil filter at the scheduled time. The oil should be changed when the engine is warm so that the oil will drain thoroughly from the engine. The procedure is as follows:

1. Place the motorcycle on the side stand.

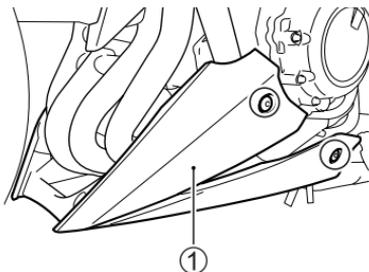

(GSX-S1000/A)

2. Remove the right and left bolts. Remove the under cowlings ①.

(GSX-S1000F/FA)

Remove the meter panel and fairings by referring to the METER PANEL REMOVAL AND INSTALLATION, FAIRING REMOVAL AND INSTALLATION section.



3. Remove the oil filler cap ②.

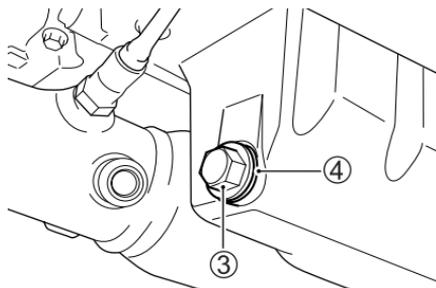

4. Remove the drain plug ③ and gasket ④ from the bottom of the engine and drain the engine oil into a drain pan.

▲ CAUTION

Hot engine oil and exhaust pipes can burn you.

Wait until the oil drain plug and exhaust pipes are cool enough to touch with bare hands before draining oil.

▲ WARNING

Children and pets may be harmed by swallowing new or used oil. Repeated, prolonged contact with used engine oil may cause skin cancer. Brief contact with oil may irritate skin.

Keep new and used oil and used oil filters away from children and pets. To minimize your exposure to used oil, wear a long-sleeve shirt and moisture-proof gloves (such as dishwashing gloves) when changing oil. If oil contacts your skin, wash thoroughly with soap and water. Launder any clothing or rags if wet with oil. Recycle or properly dispose of used oil and filters.

NOTE: Recycle or properly dispose of used oil.



Available from Suzuki dealer
Oil filter wrench (Part No. 09915-40620)

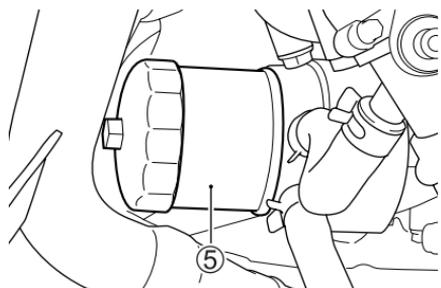

5. Turn the oil filter ⑤ counterclockwise and remove it with a Suzuki “cap type” oil filter wrench or a “strap type” filter wrench of the proper size.

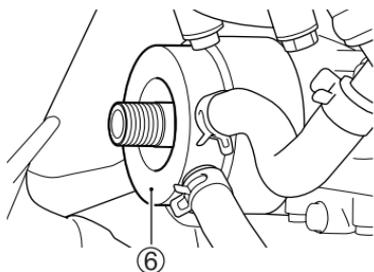

6. Wipe off the mounting surface ⑥ on the engine where the new filter will be seated with a clean rag.

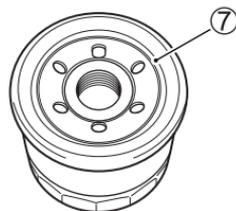

7. Smear a little engine oil around the rubber gasket ⑦ of the new oil filter.
8. Screw the new filter by hand until the filter gasket contacts the mounting surface (a small resistance will be felt).

NOTICE

Failure to use an oil filter with the correct design and thread specifications can damage your motorcycle's engine.

Be sure to use a genuine Suzuki oil filter or an equivalent one designed for your motorcycle.

NOTE: To tighten the oil filter properly, it is important to accurately identify the position at which the filter gasket first contacts the mounting surface.

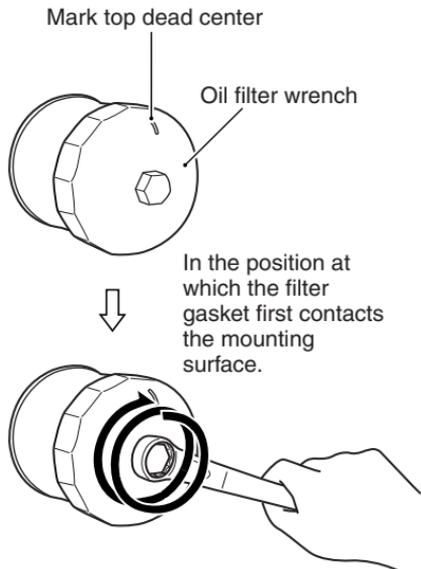

Tighten the filter 2 turns or to specified torque.

9. Mark the top dead center position on the “cap type” filter wrench or on the oil filter. Use an oil filter wrench to tighten the filter 2 turns or to specified torque.

Oil filter tightening torque:
20 N·m (2.0 kgf·m, 14.5 lbf·ft)

10. Replace the drain plug gasket with a new one. Reinstall the drain plug and gasket. Tighten the plug securely with a torque wrench. Pour 3200 ml (3.4/2.8 US/Imp. qt) of new engine oil through the filler hole and install the filler cap. Be sure to always use the specified engine oil described in the FUEL, ENGINE OIL AND COOLANT RECOMMENDATIONS section.

Drain plug tightening torque:
23 N·m (2.3 kgf·m, 16.5 lbf·ft)

NOTE: About 2800 ml (3.0/2.5 US/Imp. qt) of oil will be required when changing oil only.

NOTICE

Engine damage may occur if you use oil that does not meet Suzuki's specifications.

Be sure to use the oil specified in the FUEL, ENGINE OIL AND COOLANT RECOMMENDATIONS section.

11. Start the engine (while the motorcycle is outside on level ground) and allow it to idle for three minutes.
12. Turn the engine off and wait approximately three minutes. Recheck the oil level on the engine oil inspection window while holding the motorcycle vertically. If it is lower than the “L” mark, add oil until the oil level is between “L” mark and “F” mark. Inspect the area around the drain plug and oil filter for leaks.

NOTE: If you do not have a proper oil filter wrench, have your Suzuki dealer perform this service.

ENGINE IDLE SPEED INSPECTION

Inspect the engine idle speed. The engine idle speed should be 1050 – 1250 r/min when the engine is warm.

NOTE: If the engine idle speed is not within the specified range, ask your Suzuki dealer or a qualified mechanic to inspect and repair the motorcycle.

THROTTLE CABLE ADJUSTMENT

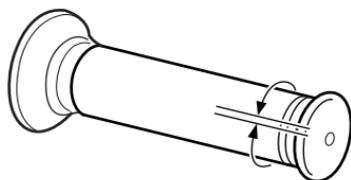

2.0 – 4.0 mm
(0.08 – 0.16 in)

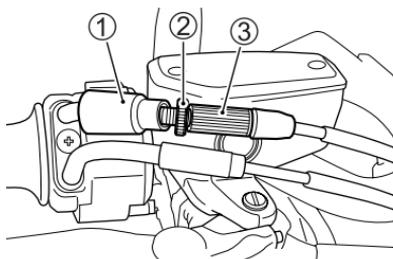

To adjust the cable play:

1. Remove the boot ①.
2. Loosen the lock nut ②.
3. Turn the adjuster ③ so that the throttle grip has 2.0 – 4.0 mm (0.08 – 0.16 in) play.
4. Tighten the lock nut ②.
5. Reinstall the boot ①.

WARNING

Inadequate throttle cable play can cause engine speed to rise suddenly when you turn the handlebars. This can lead to loss of control and an accident.

Adjust the throttle cable play so that engine idle speed does not rise due to handlebar movement.

THROTTLE CABLE BOOTS

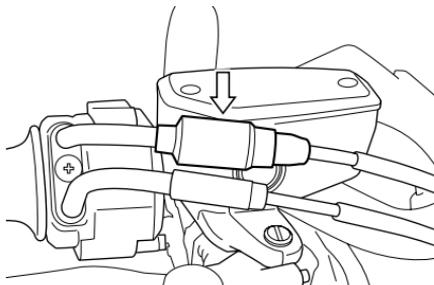

The throttle cable has boots. Check that the boots are fit securely. Do not apply water directly to the boots when washing. Wipe off dirt from the boots with a wet cloth when the boots are dirty.

CLUTCH

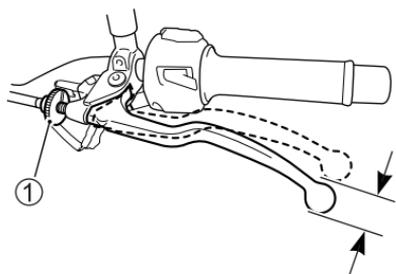

10 - 15 mm
(0.4 - 0.6 in)

At each maintenance interval, adjust the clutch cable play with the clutch cable adjuster. The cable play should be 10 - 15 mm (0.4 - 0.6 in) as measured at the clutch lever end before the clutch begins to disengage. If you find that the amount of clutch cable play is incorrect, adjust it in the following way:

1. Turn the clutch lever adjuster ① clockwise as far as it will go.

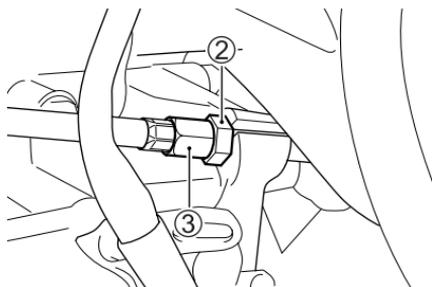

2. Loosen the cable adjuster lock nut ②, and turn the cable adjuster ③ to obtain approximately 10 - 15 mm (0.4 - 0.6 in) of free play at the clutch lever end as indicated.
3. Minor adjustment can now be made with the adjuster ①.
4. Tighten the lock nut ② after finishing adjustment.

NOTE: Any maintenance of the clutch other than the clutch cable play should be performed by your Suzuki dealer.

COOLANT COOLANT LEVEL

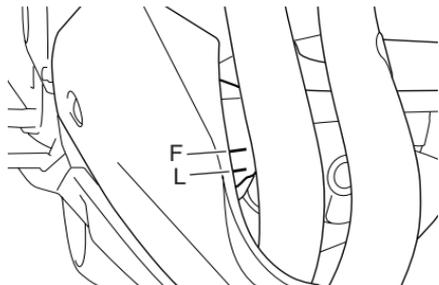

(GSX-S1000/A)

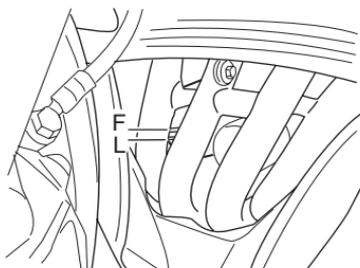

(GSX-S1000F/FA)

The coolant should be kept between the “F” (FULL) and “L” (LOW) level lines in the reservoir tank at all times. Inspect the level every time before riding with the motorcycle held vertically. If the coolant is found lower than the “L” level line, add specified engine coolant in the following way:

NOTE:

- Check the coolant level when the engine is cold.
- If the engine coolant reservoir is empty, check the radiator coolant level.

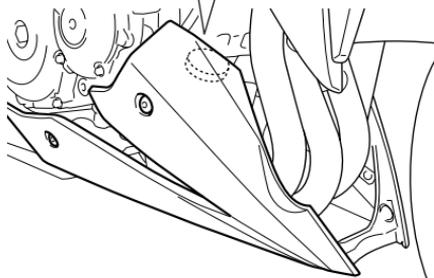
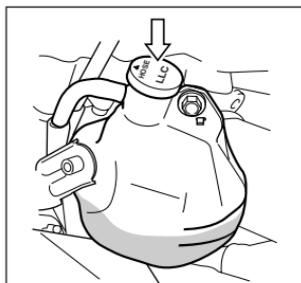

(GSX-S1000/A)

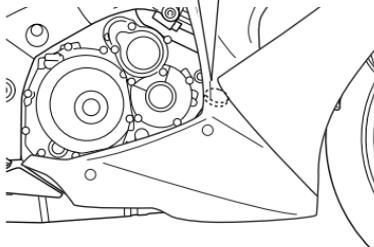
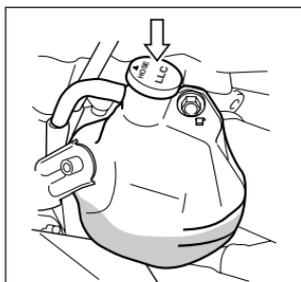

(GSX-S1000F/FA)

(GSX-S1000F/FA)

Remove the meter panel and fairings by referring to the **METER PANEL REMOVAL AND INSTALLATION, FAIRING REMOVAL AND INSTALLATION** section.

Remove the filler cap and add specified engine coolant through the filler hole until it reaches the "F" line. Refer to the **FUEL, ENGINE OIL AND COOLANT RECOMMENDATIONS** section.

NOTE: When installing the filler cap, face the triangle mark to the reservoir tank hose side.

WARNING

Engine coolant is harmful or fatal if swallowed or inhaled. Solution can be poisonous to animals.

Do not drink antifreeze or coolant solution. If swallowed, do not induce vomiting. Immediately contact a poison control center or a physician. Avoid inhaling mist or hot vapors; if inhaled, remove to fresh air. If coolant gets in eyes, flush eyes with water and seek medical attention. Wash thoroughly after handling. Keep out of the reach of children and animals.

NOTE: Adding only water will dilute the engine coolant and reduce its effectiveness. Add specified engine coolant.

CHANGING THE COOLANT

Change the coolant periodically.

NOTE: About 2800 ml (6.0/5.0 US/ Imp. qt) of coolant will required when filling the radiator and reservoir tank.

RADIATOR HOSE INSPECTION

Inspect the radiator hoses for cracks, damage or engine coolant leakage. If any defects are found, ask your Suzuki dealer to replace the radiator hose with a new one.

DRIVE CHAIN

This motorcycle has a master link type drive chain. We recommend that you take your motorcycle to an authorized Suzuki dealer or a qualified mechanic if the drive chain needs to be replaced.

The condition and adjustment of the drive chain should be checked each day before you ride. Always follow the guidelines for inspecting and servicing the chain.

WARNING

Riding with the chain in poor condition or improperly adjusted can lead to an accident.

Inspect, adjust, and maintain the chain properly before each ride, according to the instructions in this section.

Inspecting the Drive Chain

When inspecting the chain, look for the following:

- Loose pins
- Damaged rollers
- Dry or rusted links
- Kinked or binding links
- Excessive wear
- Improper chain adjustment

If you find anything wrong with the drive chain condition or adjustment, correct the problem if you know how. If necessary, consult your authorized Suzuki dealer or a qualified mechanic.

Damage to the drive chain means that the sprockets may also be damaged. Inspect the sprockets for the following:

- Excessively worn teeth
- Broken or damaged teeth
- Loose sprocket mounting nuts

If you find any of these problems with your sprocket, consult your Suzuki dealer or a qualified mechanic.

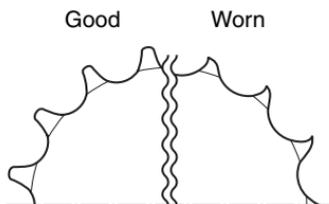

NOTE: The two sprockets should be inspected for wear when a new chain is installed and replace them if necessary.

⚠ WARNING

Improperly installing a replacement chain, or using a joint-clip type chain, can be hazardous. An incompletely riveted master link, or a joint-clip type master link, may come apart and cause an accident or severe engine damage.

Do not use a joint-clip type chain. Chain replacement requires a special riveting tool and a high-quality, non-joint-clip type chain. Ask an authorized Suzuki dealer or a qualified mechanic to perform this work.

DRIVE CHAIN CLEANING AND OILING

1. Remove dirt and dust from the drive chain. Be careful not to damage the seal ring.
2. Clean the drive chain with a sealed drive chain cleaner, or water and neutral detergent.

NOTICE

Cleaning the drive chain improperly can damage seal rings and ruin the drive chain.

- Do not use a volatile solvent such as paint thinner, kerosene and gasoline.
 - Do not use a high pressure cleaner to clean the drive chain.
 - Do not use a wire brush to clean the drive chain.
3. Use a soft brush to clean the drive chain. Be careful not to damage the seal ring even though using a soft brush.
 4. Wipe off water and neutral detergent.
 5. Lubricate with a motorcycle sealed drive chain lubricant or high viscosity oil (#80 – 90).

NOTICE

Some drive chain lubricant contains solvents and additives which could damage the seal rings in the drive chain.

Use sealed drive chain lubricant which is specifically intended for use with sealed drive chains.

6. Lubricate both front and back plates of the drive chain.
7. Wipe off excess lubricant after lubricating all around the drive chain.

DRIVE CHAIN ADJUSTMENT

Adjust the drive chain slack to the proper specification. The chain may require more frequent adjustments than indicated in the periodic maintenance schedule depending upon your riding conditions.

WARNING

Too much chain slack can cause the chain to come off the sprockets, resulting in an accident or serious damage to the motorcycle.

Inspect and adjust the drive chain slack before each use.

To adjust the drive chain, follow the procedure below:

CAUTION

A hot muffler can burn you. The muffler will be hot enough to burn you for some time after stopping the engine.

Wait until the muffler cools before adjusting the drive chain.

1. Place the motorcycle on the side stand.

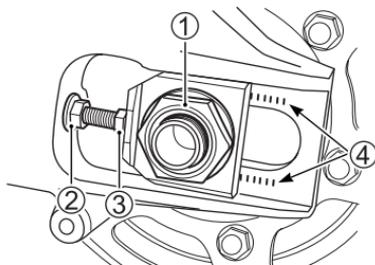

2. Loosen the axle nut ①.
3. Loosen the right and left lock nuts ②.

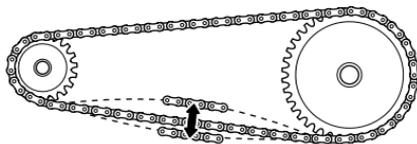

20 – 30 mm
(0.8 – 1.2 in)

4. Adjust the drive chain slack by turning the right and left chain adjuster bolts ③. At the same time that the chain is being adjusted, the rear sprocket must be kept in perfect alignment with the front sprocket. To assist you in performing this procedure, there are reference marks ④ on the swingarm and each chain adjuster which are to be aligned with each other and to be used as a reference from one side to the other.
5. Tighten the right and left lock nuts ②.
6. Tighten the axle nut ① securely.
7. Recheck the chain slack after tightening and readjust if necessary.

Rear axle nut tightening torque:
100 N·m (10.0 kgf·m, 72.5 lbf·ft)

NOTE: Do not adjust the drive chain beyond the adjustable range ④. Replace the drive chain before the drive chain exceeds the limit.

BRAKES

This motorcycle utilizes front and rear disk brakes. Proper operation of brake systems are vital to safe riding. Be sure to perform the brake inspection as scheduled.

BRAKE SYSTEM

⚠ WARNING

Failure to properly inspect and maintain your motorcycle's brake systems can increase your chance of having an accident.

Be sure to inspect the brakes before each use according to the INSPECTION BEFORE RIDING section. Always maintain your brakes according to the MAINTENANCE SCHEDULE.

Inspect your brake system for the following items daily:

- Inspect the fluid level in the reservoirs.
- Inspect the front and rear brake system for signs of fluid leakage.
- Inspect the brake hose for leakage or a cracked appearance.
- The brake lever and pedal should have the proper stroke and be firm at all times.
- Check the wear of the disk brake pads.

BRAKE HOSE INSPECTION

Inspect the brake hoses and hose joints for cracks, damage or brake fluid leakage. If any defects are found, ask your Suzuki dealer to replace the brake hose with a new one.

BRAKE FLUID

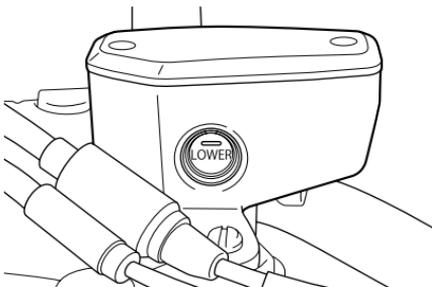

FRONT

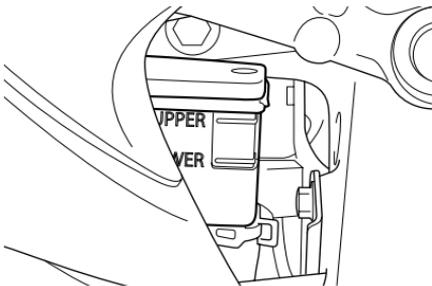

REAR

Check the brake fluid level in both the front and rear brake fluid reservoirs. If the level in either reservoir is below the lower mark, inspect for brake pad wear and leaks.

WARNING

Brake fluid will gradually absorb moisture through the brake hoses. Brake fluid with high water content lowers the boiling point and can cause brake system (including ABS) malfunction due to corrosion of brake components. Boiling brake fluid or brake system (including ABS) malfunction could result in an accident.

Replace the brake fluid every two years to maintain braking performance.

WARNING

The use of any fluid except DOT4 brake fluid from a sealed container can damage the brake system and lead to an accident.

Clean filler cap before removing. Use only DOT4 brake fluid from a sealed container. Never use or mix with different types of brake fluid.

WARNING

Brake fluid is harmful or fatal if swallowed, and harmful if it comes in contact with skin or eyes. Solution can be poisonous to animals.

If brake fluid is swallowed, do not induce vomiting. Immediately contact a poison control center or a physician. If brake fluid gets in eyes, flush eyes with water and seek medical attention. Wash thoroughly after handling. Keep out of the reach of children and animals.

NOTICE

Spilled brake fluid can damage painted surfaces and plastic parts.

Be careful not to spill any fluid when filling the brake fluid reservoir. Wipe spilled fluid up immediately.

BRAKE PAD



FRONT

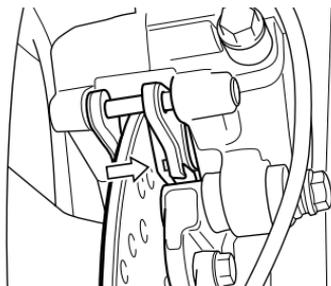

REAR

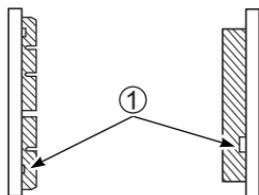

Inspect the front and rear brake pads by noting whether or not the friction pads are worn down to the grooved wear limit line ①. If a front or rear pad is worn to the grooved wear limit line, both front or both rear pads must be replaced with new ones by your authorized Suzuki dealer or a qualified service mechanic.

⚠ WARNING

Failure to inspect and maintain the brake pads and replace them when recommended can increase your chance of having an accident.

If you need to replace brake pads, have your Suzuki dealer do this work. Inspect and maintain the brake pads as recommended.

⚠ WARNING

If you ride this motorcycle after brake system repair or brake pad replacement without pumping the brake lever/pedal, you may get poor braking performance which could result in an accident.

After brake system repair or brake pad replacement, pump the brake lever/pedal several times until brake pads are pressed against the brake disks and proper lever/pedal stroke and firm feel are restored.

NOTE: Do not squeeze/depress the brake lever/pedal when the pads are not in their positions. It is difficult to push the pistons back and brake fluid leakage may result.

⚠ WARNING

Replacing only one of the two brake pads can result in uneven braking action and can increase your chance of having an accident.

Always replace both pads together.

REAR BRAKE PEDAL POSITION

The rear brake pedal position must be properly adjusted at all times or the disk brake pads will rub against the disk causing damage to the pads and to the disk surface.

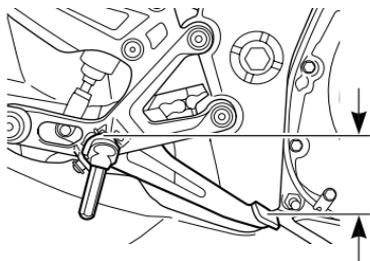

50 – 60 mm
(2.0 – 2.4 in)

Check that the rear brake pedal is 50 – 60 mm (2.0 – 2.4 in) below the top face of the footrest.

NOTE: If the rear brake pedal position is incorrect, ask your Suzuki dealer to adjust the brake pedal position because this adjustment requires tightening torque control.

NOTICE

An incorrectly adjusted brake pedal may force brake pads to continuously rub against the disk, causing damage to the pads and disk.

Follow the steps in this section to adjust the brake pedal properly.

REAR BRAKE LIGHT SWITCH

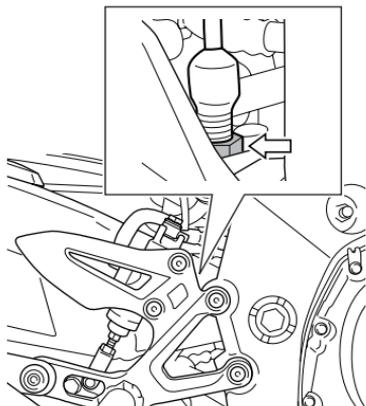

To adjust the brake light switch, hold the switch body and turn the adjuster so that the brake light will come on just before a pressure rise is felt when the brake pedal is depressed.

TIRES

▲ WARNING

The tires on your motorcycle form the crucial link between your motorcycle and the road. Failure to take the precautions below may result in an accident due to tire failure.

- Check tire condition and pressure before each ride, and adjust pressure if necessary.
- Avoid overloading your motorcycle.
- Replace a tire when worn to the specified limit, or if you find damage such as cuts or cracks.
- Always use the size and type of tires specified in this owner's manual.
- Balance the wheel after tire installation.
- Read this section of the owner's manual carefully.

WARNING

Failure to perform break-in of the tires could cause tire slip and loss of control, which could result in an accident.

Use extra care when riding on new tires. Perform proper break-in of the tires referring to the **BREAK-IN** section of this manual and avoid hard acceleration, hard cornering, and hard braking for the first 160 km (100 miles).

TIRE PRESSURE AND LOADING

Proper tire pressure and proper tire loading are important factors. Overloading your tires can lead to tire failure and loss of vehicle control.

Check tire pressure each day before you ride, and be sure the pressure is correct for the vehicle load according to the table below. Tire pressure should only be checked and adjusted before riding, since riding will heat up the tires and lead to higher inflation pressure readings.

Under-inflated tires make smooth cornering difficult, and can result in rapid tire wear. Over-inflated tires cause a smaller amount of tire to be in contact with the road, which can contribute to skidding and loss of control.

Cold Tire Inflation Pressure

LOAD TIRE	SOLO RIDING	DUAL RIDING
FRONT	250 kPa 2.50 kgf/cm ² 36 psi	250 kPa 2.50 kgf/cm ² 36 psi
REAR	290 kPa 2.90 kgf/cm ² 42 psi	290 kPa 2.90 kgf/cm ² 42 psi

NOTE: When you detect drops in tire pressure, check the tire for nails or other punctures, or a damaged wheel rim. Tubeless tires sometimes lose pressure gradually when punctured.

TIRE CONDITION AND TYPE

Proper tire condition and proper tire type affect vehicle performance. Cuts or cracks in the tires can lead to tire failure and loss of vehicle control. Worn tires are susceptible to puncture failures and subsequent loss of vehicle control. Tire wear also affects the tire profile, changing vehicle handling characteristics.

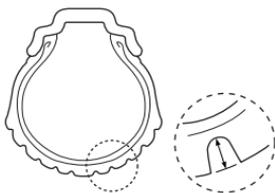

Check the condition of your tires each day before you ride. Replace tires if tires show visual evidence of damage, such as cracks or cuts, or if tread depth is less than 1.6 mm (0.06 in) front, 2.0 mm (0.08 in) rear.

NOTE: These wear limits will be reached before the wear bars molded into the tire make contact with the road.

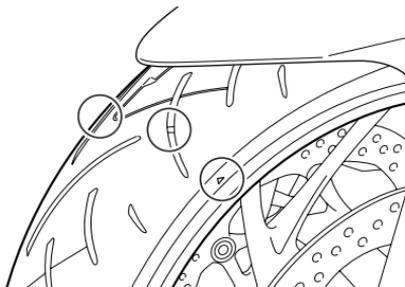

NOTE: The "△" mark indicates the place where the wear bars are molded into the tire. When the wear bars contact the road, it indicates that the tire wear limit has been reached.

When you replace a tire, be sure to replace it with a tire of the size and type listed below. If you use a different size or type of tire, vehicle handling may be adversely affected, possibly resulting in loss of vehicle control.

	FRONT	REAR
SIZE	120/70ZR17M/C (58W)	190/50ZR17M/C (73W)
TYPE	DUNLOP D214F M	DUNLOP D214 M

Be sure to balance the wheel after repairing a puncture or replacing the tire. Proper wheel balance is important to avoid variable wheel-to-road contact, and to avoid uneven tire wear.

WARNING

An improperly repaired, installed, or balanced tire can cause loss of control and an accident, or can wear out sooner.

- Ask your Suzuki dealer or a qualified mechanic to perform tire repair, replacement, and balancing because proper tools and experience are required.
- Install tires according to the rotation direction shown by arrows on the sidewall of each tire.

WARNING

Failure to follow the instructions below for tubeless tires may result in an accident due to tire failure. Tubeless tires require different service procedures than tube tires.

- Tubeless tires require an airtight seal between the tire bead and wheel rim. Special tire irons and rim protectors or a specialized tire mounting machine must be used for removing and installing tires to prevent tire or rim damage which could result in an air leak.
- Repair punctures in tubeless tires by removing the tire and applying an internal patch.
- Do not use an external repair plug to repair a puncture since the plug may work loose as a result of the cornering forces experienced by a motorcycle tire.
- After repairing a tire, do not exceed 80 km/h (50 mph) for the first 24 hours, and do not exceed 130 km/h (80 mph) thereafter. This is to avoid excessive heat build-up which could result in a tire repair failure and tire deflation.
- Replace the tire if it is punctured in the sidewall area, or if a puncture in the tread area is larger than 6 mm (3/16 in). These punctures cannot be repaired adequately.

SIDE STAND/IGNITION INTERLOCK SYSTEM

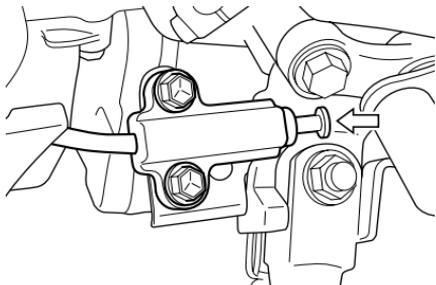

Check the side stand/ignition interlock system for proper operation as follows:

1. Sit on the motorcycle in the normal riding position, with the side stand up.
2. Shift into first gear, hold the clutch in, and start the engine.
3. While continuing to hold the clutch in, move the side stand to the down position.

If the engine stops running when the side stand is moved to the down position, then the side stand/ignition interlock system is working properly. If the engine continues to run with the side stand down and the transmission in gear, then the side stand/ignition interlock system is not working properly. Have your motorcycle inspected by an authorized Suzuki dealer or a qualified service mechanic.

WARNING

If the side stand/ignition interlock system is not working properly, it is possible to ride the motorcycle with the side stand in the down position. This may interfere with rider control during a left turn and could cause an accident.

Check the side stand/ignition interlock system for proper operation before riding. Check that the side stand is returned to its full up position before starting off.

FRONT WHEEL REMOVAL

1. Place the motorcycle on the side stand.

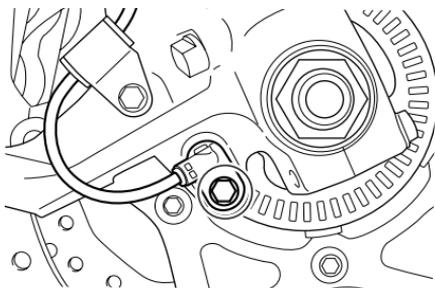

2. Remove the front wheel speed sensor by removing the mounting bolt.



3. Remove both brake calipers from the front forks by removing 2 mounting bolts ① on each of the calipers.

NOTE: Never squeeze the front brake lever with the caliper removed. It is very difficult to force the pads back into the caliper assembly and brake fluid leakage may result.

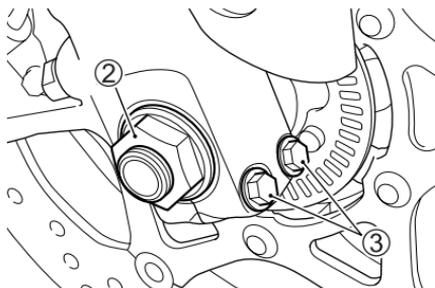

4. Remove the nut ②.
5. Loosen the axle holder bolts ③.

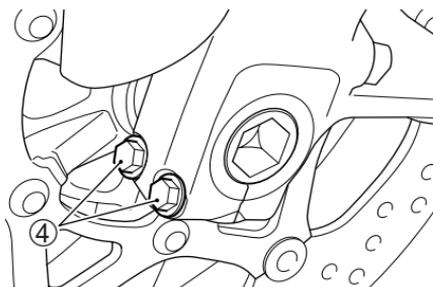

6. Loosen the axle holder bolts ④.
7. Place an accessory service stand or equivalent under the swingarm to help stabilize the rear end.
8. Carefully position a jack under the exhaust pipe and raise until the front wheel is slightly off the ground.

NOTICE

Improper jacking may cause damage to the fairing or oil filter.

Do not place the jack under the lower part of the fairing or the oil filter when jacking up the motorcycle.

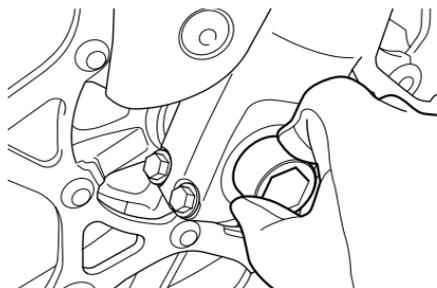

9. Draw out the axle shaft.

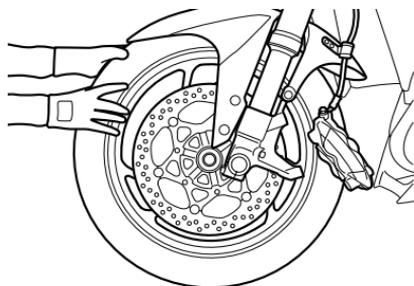

10. Slide the front wheel forward.
11. Put the new wheel in place and insert the axle shaft.
12. Remove the jack and service stand.

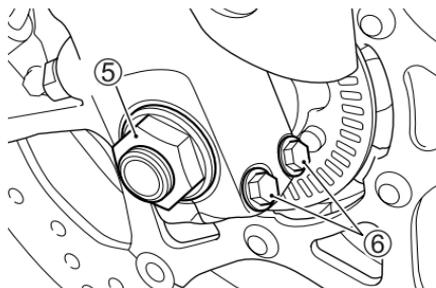

13. Hold the shaft and tighten the bolt ⑤ to the specified torque.
14. Tighten the axle holder bolts ⑥ to the specified torque.
15. Move the steering up and down several times to seat the axle shaft.

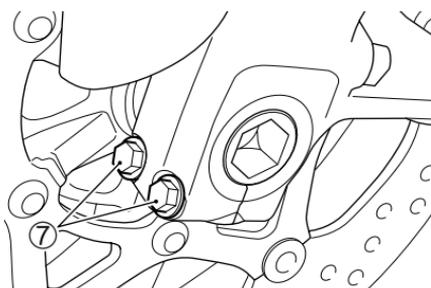

16. Tighten the axle holder bolts ⑦ to the specified torque.
17. Reinstall the brake calipers.
18. After installing the wheel, apply the brake several times to restore the proper lever stroke.

WARNING

Failure to extend brake pads after installing the wheel can cause poor braking performance and may result in an accident.

Before riding, “pump” the brake lever repeatedly until the brake pads are pressed against the brake disks and proper lever stroke and firm feel are restored. Also check that the wheel rotates freely.

WARNING

Installing the front wheel in the reverse direction can be hazardous. The tire for this motorcycle is directional. Therefore, the motorcycle may have unusual handling if the wheel is installed incorrectly.

Install the front wheel so that the tire rotates in the specified direction, as indicated by the arrow on the sidewall of the tire.

WARNING

If the bolts and nuts are not properly tightened, the wheel can come off, causing an accident.

Be sure to tighten the bolts and nuts to the specified torque. If you do not have a torque wrench or do not know how to use one, ask your authorized Suzuki dealer to check the bolts and nuts.

Front axle tightening torque:
100 N·m (10.0 kgf-m, 72.5 lbf-ft)

Front axle holder bolt
tightening torque:
23 N·m (2.3 kgf-m, 16.5 lbf-ft)

Front brake caliper mounting bolt
tightening torque:
39 N·m (3.9 kgf-m, 28.0 lbf-ft)

REAR WHEEL REMOVAL

CAUTION

A hot muffler can burn you.

Wait until the muffler cools before removing the axle nut.

NOTICE

Removing the rear wheel without use of an accessory stand can result in your motorcycle falling over and being damaged.

Do not attempt roadside removal of the rear wheel. Only remove the rear wheel at a properly equipped servicing facility using an accessory service stand.

1. Place the motorcycle on the side stand.

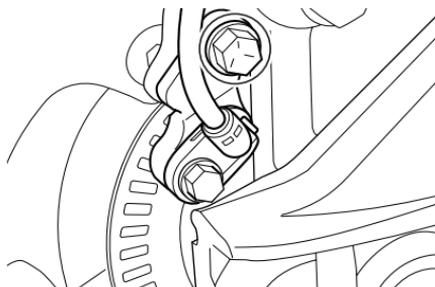

2. Remove the rear wheel speed sensor bracket by removing the mounting bolt.

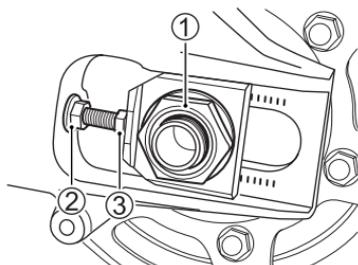

3. Remove the axle nut ①.
4. Place an accessory service stand or an equivalent stand under the swingarm to lift the rear wheel slightly off the ground.
5. Loosen the right and left lock nuts ②. Turn the right and left chain adjuster bolts ③ clockwise.

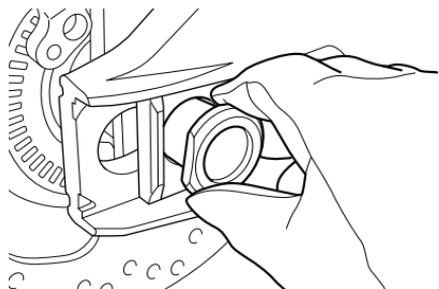

6. Draw out the axle shaft.

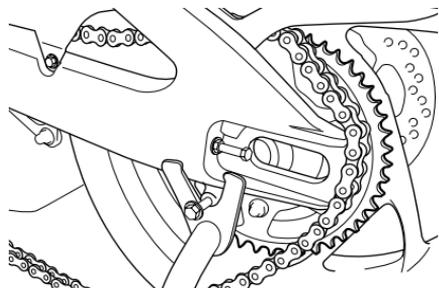

7. With the wheel moved forward, remove the chain from the sprocket.

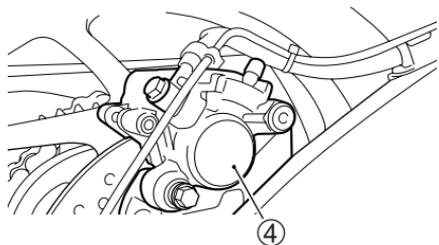

8. Remove the rear brake caliper assembly ④.

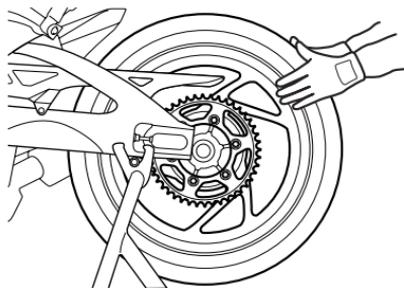

9. Pull the rear wheel assembly rearward.

NOTE: Never depress the rear brake pedal with the rear wheel removed. It is very difficult to force the pads back into the caliper assembly.

10. To replace the wheel reverse the complete sequence listed.

11. Adjust the drive chain slack.

12. After installing the wheel, apply the brake several times and then check that the wheel rotates freely.

WARNING

Failure to adjust the drive chain and failure to torque bolts and nuts properly could lead to an accident.

- After installing the rear wheel, adjust the drive chain as described in the **DRIVE CHAIN ADJUSTMENT** section.
- Torque bolts and nuts to the proper specifications. If you are not sure of the proper procedure, have your authorized Suzuki dealer or a qualified mechanic do this.

Rear axle nut tightening torque:
100 N·m (10.0 kgf·m, 72.5 lbf·ft)

WARNING

Failure to extend brake pads after installing the wheel can cause poor braking performance and may result in an accident.

Before riding, “pump” the brake pedal repeatedly until brake pads are pressed against the brake disks and proper pedal stroke and firm feel are restored. Also check that the wheel rotates freely.

LIGHT BULB REPLACEMENT

The wattage rating of each bulb is shown on the table below. When replacing a burned out bulb, always use the exact same wattage rating. Using other than the specified rating can result in overloading the electrical system or premature failure of a bulb.

NOTICE

Failure to use a light bulb with the correct wattage rating can overload the electrical system of your motorcycle or cause the bulb to burn out sooner.

Use only the light bulbs shown in the chart as replacement bulbs.

Headlight	12V 60/55W (H4) (GSX-S1000/A)
	12V 55W (H7) × 2 (GSX-S1000F/FA)
Turn signal light	12V 21W × 4
License plate light	12V 5W

HEADLIGHT

To replace the headlight bulb, perform the following steps:

(GSX-S1000/A)

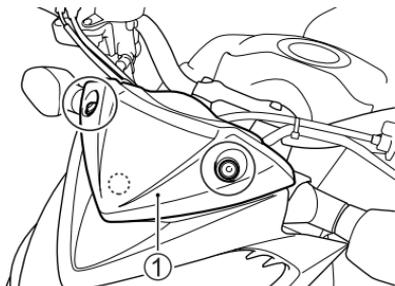

1. Remove the bolts. Unhook the hook and remove the meter cover ①.

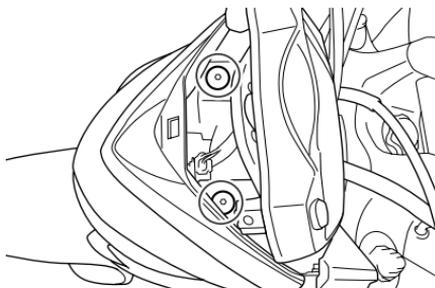

2. Remove the bolts. Pull open the headlight assembly ②.

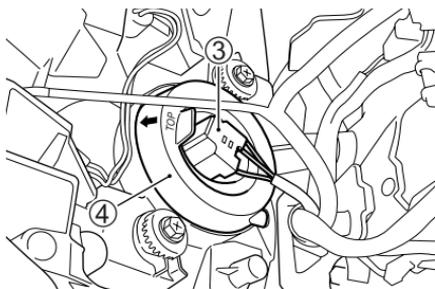

3. Disconnect the socket ③ from the headlight and remove the rubber cap ④.

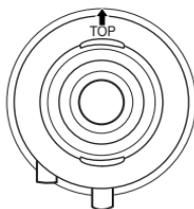

NOTE: When installing the rubber cap, face the "TOP" mark (arrow mark) to the upper side.

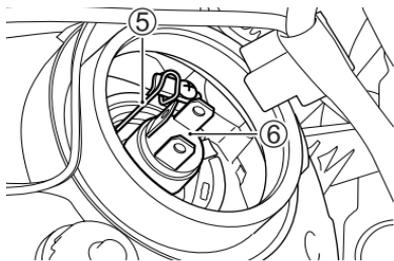

4. Unhook the bulb holder spring ⑤ and pull out the bulb ⑥.
5. To replace the headlight bulb, reverse the above sequence.

NOTICE

The headlight bulb's life may be shortened by oil from your fingers if you touch it.

When replacing the headlight bulb, be careful not to touch the glass. Grasp the new bulb with a clean cloth.

(GSX-S1000F/FA)

1. Remove the right and left meter panels by referring to the METER PANEL REMOVAL AND INSTALLATION section.

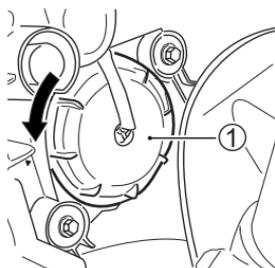

Low beam

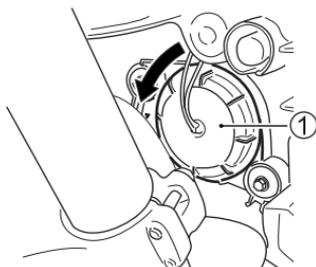

High beam

2. Turn the cap ① counterclockwise and remove it.

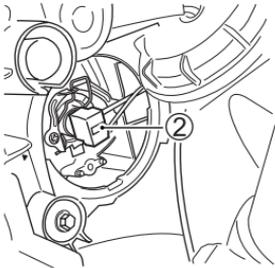

Low beam

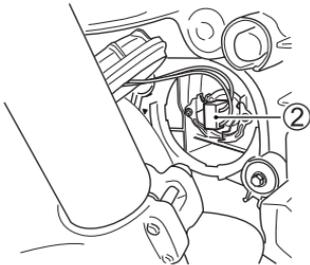

High beam

3. Disconnect the socket ②.

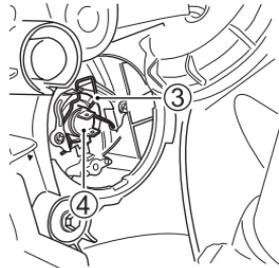

Low beam



High beam

4. Unhook the bulb holder spring ③ and pull out the bulb ④.
5. To replace the headlight bulb, reverse the above sequence.

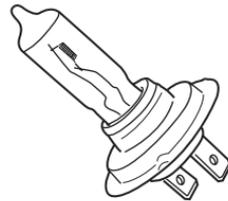

NOTICE

The headlight bulb's life may be shortened by oil from your fingers if you touch it.

When replacing the headlight bulb, be careful not to touch the glass. Grasp the new bulb with a clean cloth.

HEADLIGHT BEAM ADJUSTMENT

The headlight beam can be adjusted both up and down or right and left if necessary.

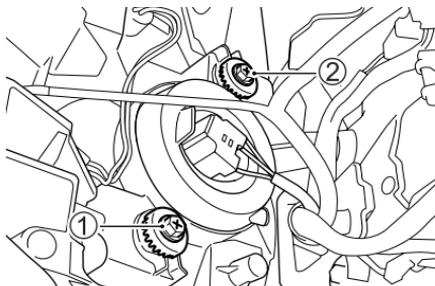
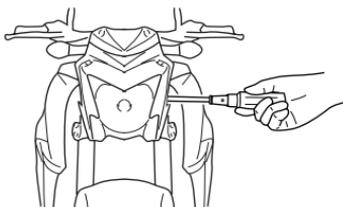

(GSX-S1000/A)

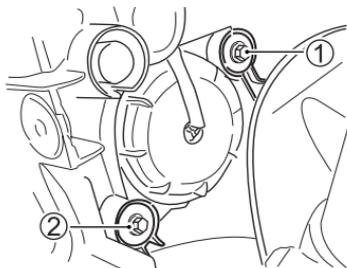
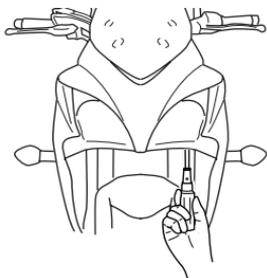

Low beam

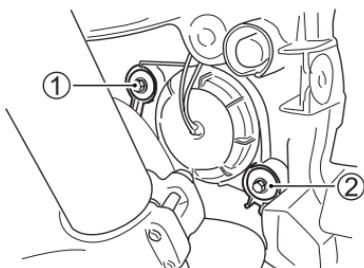

High beam

(GSX-S1000F/FA)

To adjust the beam up and down:

Turn the adjuster ① clockwise or counterclockwise.

To adjust the beam right and left:

Turn the adjuster ② clockwise or counterclockwise.

TURN SIGNAL LIGHT

To replace the turn signal light bulb, follow these directions.

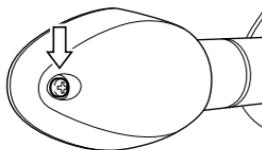

1. Remove the screw and take off the lens.

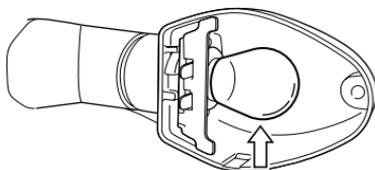

2. Push in on the bulb, twisting it to the left, and pull it out.
3. To fit the replacement bulb, push it in and twist it to the right while pushing.

NOTICE

Overtightening the screws when reinstalling the lens may cause the lens to crack.

Tighten the screws only until they are snug.

LICENSE PLATE LIGHT

To replace the license plate light bulb, follow the procedure steps:

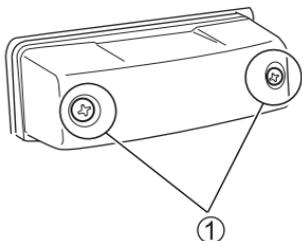

1. Remove the screws ① and take off the cover with the lens.

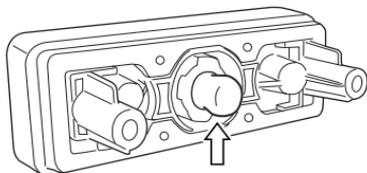

2. Pull off the bulb from the socket.
3. To replace the license plate light, reverse the above steps.

FUSES

If something electrical on your motorcycle stops working, the first thing you should check for is a blown fuse. The electrical circuits on the motorcycle are protected from overload by fuses in the circuits.

If a blown fuse is found, then the electrical problem must be inspected and repaired before replacing the blown fuse with a new fuse. Consult your Suzuki dealer for the electrical system check and repair.

⚠ WARNING

Replacing a fuse with a fuse that has an incorrect amperage rating or substitute, e.g. aluminum foil or wire, may cause serious damage to the electrical system and possibly fire. Always replace a blown fuse with a fuse of the same amperage rating.

If the new fuse blows in a short time, the electrical problem may not be fixed. Have your motorcycle inspected immediately by your Suzuki dealer.

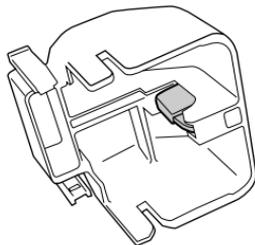
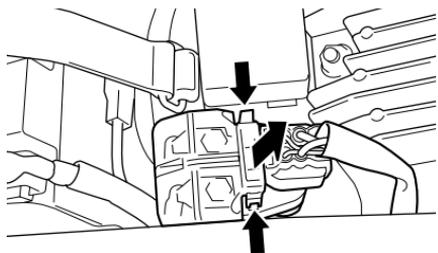

The main fuse is located under the front seat. To access the fuse, remove the front seat by referring to the SEAT LOCK AND HELMET HOLDERS section. One 30A spare fuse is located inside the fuse box cover.

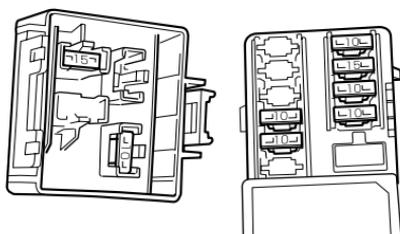

(GSX-S1000/F)

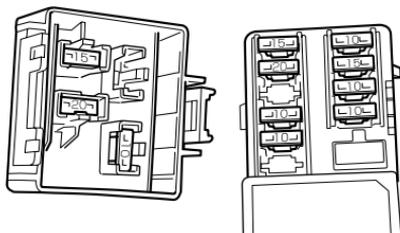

(GSX-S1000A/FA)

The fuses are located under the front seat. Two spare fuses (one 10A and one 15A) are provided inside the fuse box.

(GSX-S1000A/FA)

The ABS fuses are located under the front seat. Two spare fuses (one 20A and one 15A) are provided with the fuse box.

FUSE LIST

- 30A MAIN fuse protects all electrical circuits.
- 10A HEAD-HI fuse protects the headlight high beam and speedometer.
- 10A HEAD-LO fuse protects the headlight low beam.
- 10A IGNITION fuse protects the cooling fan relay, ISC, ignition coils, starter relay, fuel pump relay, solenoid, ECM, oxygen sensor, side stand relay and Immobilizer (if equipped).
- 10A SIGNAL fuse protects the horn, turn signal lights, position lights, taillight, stop lamp, license light and speedometer.
- 10A FUEL fuse protects the speedometer, fuel injectors, fuel pump and ECM.
- 15A FAN fuse protects the cooling fan motor.

(GSX-S1000A/FA)

- 20A ABS MOT fuse protects ABS system.
- 15A ABS VALVE fuse protects ABS system.

HANDLEBAR FITTING

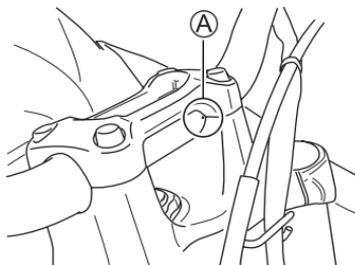

Align the dot mark on the handlebar with the mating surface **A**.

CATALYTIC CONVERTER

The purpose of the catalytic converter is to minimize the amount of harmful pollutants in your motorcycle's exhaust. Use of leaded fuel in motorcycles equipped with catalytic converters is prohibited because lead deactivates the pollutant-reducing components of the catalyst system.

The converter is designed to last the life of the motorcycle under normal usage and when unleaded fuel is used. Not special maintenance is required on the converter. However, it is very important to keep the engine properly tuned. Engine misfiring, which can result from an improperly tuned engine, may cause overheating of the catalyst. This may result in permanent heat damage to the catalyst and other motorcycle components.

NOTICE

Improper motorcycle operation can cause catalyst or other motorcycle damage.

To avoid damage to the catalyst or other related components, you should take the following precautions:

- **Maintain the engine in the proper operating condition.**
- **In the event of an engine malfunction, particularly one involving engine misfire or other apparent performance loss, stop riding the motorcycle and turn off the engine and have the motorcycle serviced promptly.**
- **Do not shut off the engine or interrupt the ignition when the transmission is in gear and the motorcycle is in motion.**
- **Do not try to start the engine by pushing the motorcycle or by coasting down a hill.**
- **Do not idle the engine with any spark plug wires disconnected or removed, such as during diagnostic testing.**
- **Do not idle the vehicle for prolonged periods if idling seems rough or there are other malfunctions.**
- **Do not allow the fuel tank to get near the empty level.**

⚠ WARNING

If you park or operate the motorcycle in areas where there are combustible materials such as dry grass or leaves, these materials may come in contact with the catalytic converter or other hot exhaust components. This can cause a fire.

Avoid parking or operating your vehicle in areas with any combustible materials.



TROUBLESHOOTING

FUEL SUPPLY CHECK	7-2
IGNITION SYSTEM CHECK	7-3
ENGINE STALLING	7-3

TROUBLESHOOTING

This troubleshooting guide is provided to help you find the cause of some common complaints.

NOTICE

Improper repairs or adjustments may damage the motorcycle instead of fixing it. Such damage may not be covered under warranty.

If you are not sure about the proper action, consult your Suzuki dealer about the problem.

If the engine refuses to start, perform the following inspections to determine the cause.

FUEL SUPPLY CHECK

If the odometer displays "FI" and malfunction indicator light comes on, trouble in the fuel injection system, take your machine to an authorized Suzuki dealer. Refer to the "INSTRUMENT PANEL" section for an explanation of the malfunction indicator light.

IGNITION SYSTEM CHECK

1. Remove the spark plugs and reattach them to the spark plug caps.
2. While holding the spark plug firmly against the crank case of the engine, push the starter switch with the ignition switch in the "ON" position, the engine stop switch in the "O" position, the transmission in neutral, and the clutch disengaged. If the ignition system is operating properly, a blue spark should jump across the spark plug gap.
3. If there is no spark, clean the spark plug. Replace it if necessary. Retry the above procedure with the cleaned spark plug or a new one.
4. If there is still no spark, consult your Suzuki dealer for repairs.

WARNING

Performing the spark test improperly can be hazardous. You could get a high voltage electrical shock if you are not familiar with this procedure.

Do not perform this check if you are not familiar with the procedure. Do not point the spark plug near the spark plug hole during this test. Do not perform this test if you have a heart condition or wear a pacemaker.

ENGINE STALLING

1. Make sure there is enough fuel in the fuel tank.
2. If the odometer displays "F" and malfunction indicator light comes on, trouble in the fuel injection system, take your machine to an authorized Suzuki dealer. Refer to the "INSTRUMENT PANEL" section for an explanation of the malfunction indicator light.
3. Check the ignition system for intermittent spark.
4. Check the idle speed. If necessary, adjust it using a tachometer. The correct idle speed is 1050 – 1250 r/min.



STORAGE PROCEDURE AND MOTORCYCLE CLEANING

STORAGE PROCEDURE	8-2
PROCEDURE FOR RETURNING TO SERVICE	8-3
CORROSION PREVENTION	8-3
MOTORCYCLE CLEANING	8-4
INSPECTION AFTER CLEANING	8-6

STORAGE PROCEDURE AND MOTORCYCLE CLEANING

STORAGE PROCEDURE

If your motorcycle is to be left unused for an extended period of time, it needs special servicing requiring appropriate materials, equipment and skill. For this reason, Suzuki recommends that you trust this maintenance work to your Suzuki dealer. If you wish to service the machine for storage yourself, follow the general guidelines below:

MOTORCYCLE

Clean the entire motorcycle. Place the motorcycle on the side stand on a firm, flat surface where it will not fall over.

FUEL

1. Fill the fuel tank to the top with fuel mixed with the amount of gasoline stabilizer recommended by the stabilizer manufacturer.
2. Run the engine for a few minutes until the stabilized gasoline fills the fuel injection system.

ENGINE

1. Pour one tablespoon of motor oil into each spark plug hole. Reinstall the spark plugs and crank the engine a few times.
2. Drain the engine oil thoroughly and refill the crankcase with fresh engine oil all the way up to the filler hole.
3. Cover the air cleaner intake and the muffler outlet with oily rags to prevent humidity from entering.

BATTERY

1. Remove the battery from the motorcycle by referring to the BATTERY section.
2. Clean the outside of the battery with a mild soap and remove corrosion from the terminals and wiring harness.
3. Store the battery in a room above freezing.

TIRES

Inflate tires to the normal pressure.

EXTERNAL

- Spray all vinyl and rubber parts with rubber protectant.
- Spray unpainted surfaces with rust preventative.
- Coat painted surfaces with car wax.

MAINTENANCE DURING STORAGE

Once a month, recharge the battery. The standard charging rate is 1.2A x 5 to 10 hours.

PROCEDURE FOR RETURNING TO SERVICE

1. Clean the entire motorcycle.
2. Remove the oily rags from the air cleaner intake and muffler outlet.
3. Drain all the engine oil. Install a new oil filter and fill the engine with fresh oil as outlined in this manual.
4. Remove the spark plugs. Turn the engine a few times. Reinstall the spark plugs.
5. Reinstall the battery by referring to the BATTERY section.
6. Make sure that the motorcycle is properly lubricated.
7. Perform the INSPECTION BEFORE RIDING as listed in this manual.
8. Start the motorcycle as outlined in this manual.

CORROSION PREVENTION

It is important to take good care of your motorcycle to protect it from corrosion and keep it looking new for years to come.

Important Information About Corrosion

Common causes of corrosion

- Accumulation of road salt, dirt, moisture, or chemicals in hard-to-reach areas.
- Chipping, scratches, and any damage to treated or painted metal surfaces resulting from minor accidents or impacts from stones and gravel.

Road salt, sea air, industrial pollution, and high humidity will all contribute to corrosion.

How to Help Prevent Corrosion

- Wash your motorcycle frequently, at least once a month. Keep your motorcycle as clean and dry as possible.
- Remove foreign material deposits. Foreign material such as road salt, chemicals, road oil or tar, tree sap, bird droppings and industrial fall-out may damage your motorcycle's finish. Remove these types of deposits as quickly as possible. If these deposits are difficult to wash off, an additional cleaner may be required. Follow the manufacturer's directions when using these special cleaners.

- Repair finish damage as soon as possible. Carefully examine your motorcycle for damage to the painted surfaces. Should you find any chips or scratches in the paint, touch them up immediately to prevent corrosion from starting. If the chips or scratches have gone through to the bare metal, have a Suzuki dealer make the repair.
- Store your motorcycle in a dry, well-ventilated area. If you often wash your motorcycle in the garage or if you frequently park it inside when wet, your garage may be damp. The high humidity may cause or accelerate corrosion. A wet motorcycle may corrode even in a heated garage if the ventilation is poor.
- Cover your motorcycle. Exposure to mid-day sun can cause the colors in paint, plastic parts, and instrument faces to fade. Covering your motorcycle with a high-quality, "breathable" motorcycle cover can help protect the finish from the harmful UV rays in sunlight, and can reduce the amount of dust and air pollution reaching the surface. Your Suzuki dealer can help you select the right cover for your motorcycle.

MOTORCYCLE CLEANING

WASHING THE MOTORCYCLE

When washing the motorcycle, follow the instructions below:

1. Remove dirt and mud from the motorcycle with cool running water. You may use a soft sponge or brush. Do not use hard materials which can scratch the paint.
2. Wash the entire motorcycle with a mild detergent or car wash soap using a sponge or soft cloth. The sponge or cloth should be frequently soaked in the soap solution.

NOTE: Clean the motorcycle with cool water immediately after riding on road salt or riding along the coast. Be sure to use cool water because warm water can hasten corrosion.

NOTE: Avoid spraying or allowing water to flow over the following places:

- Ignition switch
- Spark plugs
- Fuel tank cap
- Fuel injection system
- Brake master cylinders
- Throttle cable boots

NOTICE

High pressure washers such as those found at coin-operated car washes have enough pressure to damage the parts of your motorcycle. It may cause rust, corrosion and increase wear. Parts cleaner can also damage motorcycle parts.

Do not use high pressure washers to clean your motorcycle. Do not use parts cleaner on throttle body and fuel injection sensors.

3. Once the dirt has been completely removed, rinse off the detergent with running water.
4. After rinsing, wipe off the motorcycle with a wet chamois or cloth and allow it to dry in the shade.
5. Check carefully for damage to painted surfaces. If there is any damage, obtain "touch-up" paint and "touch-up" the damage following the procedure below:
 - a. Clean all damaged spots and allow them to dry.
 - b. Stir the paint and "touch-up" the damaged spots lightly with a small brush.
 - c. Allow the paint to dry completely.

NOTE: The headlight lens can be fogged after washing the motorcycle or riding in the rain. Headlight fogging will be cleared gradually when the headlight is turned on. When clearing the headlight lens fogging, run the engine to avoid battery discharge.

NOTICE

Cleaning your motorcycle with any alkaline or strong acid cleaner, gasoline, brake fluid, or any other solvent will damage the motorcycle parts.

Clean only with soft cloth and warm water with mild detergent.

WINDSHIELD CLEANING (GSX-S1000F/FA)

Clean the windshield with a soft cloth and warm water with a mild detergent. If scratched, polish with a commercially available plastic polish. Replace the windshield if it becomes scratched or discolored so as to obstruct view. When replacing the windshield, use a Suzuki replacement windshield.

WAXING THE MOTORCYCLE

After washing the motorcycle, waxing and polishing are recommended to further protect and beautify the paint.

- Only use waxes and polishes of good quality.
- When using waxes and polishes, observe the precautions specified by the manufacturers.

SPECIAL CARE FOR MATTE FINISH PAINT

Do not use polishing compounds or waxes that contain polishing compounds on surfaces which have a matte finish. The use of polishing compounds will change the appearance of the matte finish.

Solid type waxes may be difficult to remove from surfaces with a matte finish.

Friction while riding, excessive rubbing or polishing of a surface with a matte finish will change its appearance.

INSPECTION AFTER CLEANING

For extended life of your motorcycle, lubricate it according to the "LUBRICATION POINTS" section.

WARNING

Operating the motorcycle with wet brakes can be hazardous. Wet brakes may not provide as much stopping power as dry brakes. This could lead to an accident.

Test your brakes after washing the motorcycle, while riding at slow speed. If necessary, apply the brakes several times to let friction dry out the linings.

Follow the procedures in the "INSPECTION BEFORE RIDING" section to check your motorcycle for any problems that may have arisen during your last ride.



SPECIFICATIONS

DIMENSIONS AND CURB MASS

Overall length	2115 mm (83.3 in)
Overall width	795 mm (31.3 in)
Overall height	1080 mm (42.5 in)
Wheelbase	1460 mm (57.5 in)
Ground clearance	140 mm (5.5 in)
Seat height	810 mm (31.9 in)
Curb mass	207 kg (456 lbs) ... GSX-S1000
	209 kg (461 lbs) ... GSX-S1000A
	212 kg (467 lbs) ... GSX-S1000F
	214 kg (472 lbs) ... GSX-S1000FA

ENGINE

Type	Four-stroke, liquid-cooled, DOHC
Number of cylinders	4
Bore	73.4 mm (2.890 in)
Stroke	59.0 mm (2.323 in)
Displacement	999 cm ³ (61.0 cu. in)
Compression ratio	12.2 : 1
Fuel system	Fuel injection
Air cleaner	Paper element
Starter system	Electric
Lubrication system	Wet sump

DRIVE TRAIN

Clutch	Wet multi-plate type
Transmission	6-speed constant mesh
Gearshift pattern	1-down, 5-up
Primary reduction ratio	1.553 (73/47)
Gear ratios, Low	2.562 (41/16)
2nd	2.052 (39/19)
3rd	1.714 (36/21)
4th	1.500 (36/24)
5th	1.360 (34/25)
Top	1.269 (33/26)
Final reduction ratio	2.588 (44/17)
Drive chain	RK525GSH, 116 links

CHASSIS

Front suspension	Inverted telescopic, coil spring, oil damped
Rear suspension	Link type, coil spring, oil damped
Front fork stroke	120 mm (4.7 in)
Rear wheel travel	130 mm (5.1 in)
Caster	25°
Trail	100 mm (3.9 in)
Steering angle	31° (right and left)
Turning radius	3.1 m (10.2 ft)
Front brake	Disk brake, twin
Rear brake	Disk brake
Front tire size	120/70ZR17M/C (58W), tubeless
Rear tire size	190/50ZR17M/C (73W), tubeless

ELECTRICAL

Ignition type	Electronic ignition (Transistorized)
Spark plug	NGK CR9EIA-9 or DENSO IU27D
Battery	12V 36.0 kC(10 Ah)/10 HR
Generator	Three-phase A.C. generator
Main fuse	30A
Fuse	10/10/10/10/10/15A
ABS fuse	20/15A ... GSX-S1000A/FA
Headlight	12V 60/55W (H4) ... GSX-S1000/A
	12V 55W (H7) × 2 ... GSX-S1000F/FA
Position light	LED
Brake light/Taillight.....	LED
Turn signal light	12V 21W × 4
License plate light.....	12V 5W
Instrument panel light.....	LED
Neutral indicator light.....	LED
High beam indicator light.....	LED
Turn signal indicator light.....	LED
Oil pressure/Coolant temperature indicator light	LED
Malfunction indicator light.....	LED
Traction control system indicator light	LED
ABS indicator light.....	LED ... GSX-S1000A/FA
Immobilizer indicator light (if equipped).....	LED

CAPACITIES

Fuel tank.....	17.0 L (4.5/3.7 US/Imp. gal)
Engine oil, oil change	2800 ml (3.0/2.5 US/Imp. qt)
With filter change.....	3200 ml (3.4/2.8 US/Imp. qt)
Coolant	2.8 L (3.0/2.5 US/Imp. qt)

INDEX

- A**
ACCESSORY USE AND
MOTORCYCLE LOADING 1-2
AIR CLEANER..... 6-21
ALLOW THE ENGINE OIL TO
CIRCULATE BEFORE RIDING 4-3
AVOID CONSTANT
LOW SPEED 4-2
- B**
BATTERY 6-19
BRAKES 6-38
BREAKING IN THE NEW TIRES 4-2
- C**
CATALYTIC CONVERTER 6-61
CLUTCH 6-31
COOLANT 6-32
CORROSION PREVENTION 8-3
- D**
DRIVE CHAIN..... 6-34
- E**
ENGINE COOLANT SOLUTION 3-5
ENGINE IDLE SPEED
INSPECTION..... 6-29
ENGINE OIL 3-4,6-24
ENGINE STALLING..... 7-3
- F**
FAIRING REMOVAL AND
INSTALLATION
(GSX-S1000F/FA) 6-10
FRONT WHEEL REMOVAL 6-47
FUEL HOSE 6-24
FUEL OCTANE RATING 3-2
FUEL SUPPLY CHECK..... 7-2
FUEL TANK CAP..... 2-32
FUEL TANK LIFT..... 6-15
FUSES..... 6-58
- G**
GEARSHIFT LEVER 2-33
- H**
HANDLEBAR FITTING..... 6-60
- I**
IGNITION SWITCH..... 2-7
IGNITION SYSTEM CHECK 7-3
INSPECTION AFTER CLEANING... 8-6
INSPECTION BEFORE RIDING 4-3
INSTRUMENT PANEL 2-10
- K**
KEY..... 2-5

L		R	
LABELS	1-5	REAR BRAKE PEDAL	2-33
LEFT HANDLEBAR	2-24	REAR WHEEL REMOVAL	6-50
LIGHT BULB REPLACEMENT	6-52	RIDING ON HILLS	5-6
LOCATION OF PARTS	2-2	RIGHT HANDLEBAR	2-29
LUBRICATION POINTS	6-18		
LUGGAGE STRAPS	2-36	S	
		SAFE RIDING RECOMMENDATION FOR MOTORCYCLE RIDERS	1-4
M		SEAT LOCK AND HELMET HOLDERS	2-34
MAINTENANCE SCHEDULE	6-2	SERIAL NUMBER LOCATION	1-6
MAXIMUM ENGINE SPEED RECOMMENDATION	4-2	SIDE STAND	2-37
METER PANEL REMOVAL AND INSTALLATION (GSX-S1000F/FA)	6-6	SIDE STAND/IGNITION INTERLOCK SYSTEM	6-46
MOTORCYCLE CLEANING	8-4	STARTING OFF	5-3
		STARTING THE ENGINE	5-2
N		STOPPING AND PARKING	5-6
NOISE CONTROL SYSTEM (AUSTRALIA ONLY)	1-6	STORAGE PROCEDURE	8-2
		SUSPENSION ADJUSTMENT	2-38
O		T	
OBSERVE YOUR FIRST AND MOST CRITICAL SERVICE	4-3	THROTTLE CABLE ADJUSTMENT	6-30
OXYGENATED FUEL RECOMMENDATION	3-2	TIRES	6-42
		TOOLS	6-6
P		U	
PROCEDURE FOR RETURNING TO SERVICE	8-3	USING THE TRANSMISSION	5-4
		V	
		VARY THE ENGINE SPEED	4-2



6-2-1, Sonnejidai, Hamakita-ku, Hamamatsu, Shizuoka 434-0046, Japan

DECLARATION OF CONFORMITY

For

CE0891

Product: Immobilizer
Model: SZ137

Technical Construction File held by
ASAHI DENSO CO., LTD.
6-2-1 Sonnejidai, Hamakita-ku,
Hamamatsu, Shizuoka, 434-0046 Japan

Notified Body - R&TTE Directive
Traf Global
100 Frobsisher Business Park, Leigh Simon
Road,
Malvern, Worcestershire, WR14 1BX, UK

Standard used for comply
EN60965:2002+A1:2006+A.2:2010+1 (incl.A12:2011)

R&TTE Directive
(Article 3.1(a) Safety)
R&TTE Directive
(Article 3.1(b) EMC)
EN301-489-1 V1.8.1:2008
EN301-489-3 V1.4.1:2002
R&TTE Directive
(Article 3.2 Spectrum)
EN 300 330-1 V1.7.1 : 2010-02
EN 300 330-2 V1.5.1 : 2010-02

Means of Conformity
We declare under our sole responsibility that the Product (s) is conformity with the essential requirements and other relevant requirements of the Radio and Telecommunication Terminal Equipment (R&TTE) Directive (1999/5/EC).

Date of Issue: June 27, 2011

Signature of Responsible Person:

Michiyuki Suzuki

Section chief
Engineering Department

CE0891

Herby, ASAHI DENSO CO., LTD. declares that this Immobilizer for Motor Cycle (SZ137) is in compliance with the essential requirements and other relevant provisions of Directive 1999/5/EC.

Underskrivade ASAHI DENSO CO., LTD. erklærer hermed, at følgende udstyr: Immobilizer for Motor Cycle (SZ137) overholder de væsentlige krav og øvrige relevante krav i direktiv 1999/5/EF.

Hiermit erkläre ASAHI DENSO CO., LTD. dass sich das Gerät Immobilizer for Motor Cycle (SZ137) im wesentlichen mit den wesentlichen Anforderungen und den anderen einschlägigen Bestimmungen der Richtlinie 1999/5/EG befindet.

Käsitseleväga kinnitab ASAHI DENSO CO., LTD seadmeid immobilizer for Motor Cycle (SZ137) vastavast direktiivi 1999/5/EÜ põhinõuetele ja nimetatud direktiivist tulenevatele teistele asjakasastele sätetele.

Por medio de la presente ASAHI DENSO CO., LTD declara que el Immobilizer for Motor Cycle (SZ137) cumple con los requisitos esenciales y cualesquiera otras disposiciones aplicables o exigibles de la Directiva 1999/5/EC.

ME THN ΠΑΡΟΥΣΙΑ ΑΣΑΗΙ ΔΕΝΣΟ CO., LTD ΔΗΛΩΝΕΙ ΟΤΙ ΗΜΟΒΙΛΙΖΕΡ ΦΟΡ ΜΟΤΟΡ ΣΥΚΛΗ (SZ137) ΣΥΜΜΟΡΦΩΝΕΤΑΙ ΠΡΟΣ ΤΙΣ ΟΥΣΙΩΔΕΙΣ ΑΠΑΙΤΗΣΕΙΣ ΚΑΙ ΤΙΣ ΑΝΑΡΤΗΣΙΜΕΣ ΣΧΗΤΙΚΕΣ ΑΠΑΙΤΗΣΕΙΣ ΤΗΣ ΟΔΗΓΙΑΣ 1999/5/ΕΚ.

Par la présente ASAHI DENSO CO., LTD déclare que l'appareil Immobilizer for Motor Cycle (SZ137) est conforme aux exigences essentielles et aux autres dispositions pertinentes de la directive 1999/5/CE.

Con la presente ASAHI DENSO CO., LTD dichiara che questo Immobilizer for Motor Cycle (SZ137) è conforme ai requisiti essenziali ed alle altre disposizioni pertinenti stabilite dalla direttiva 1999/5/CE.

Hierbij verklaart ASAHI DENSO CO., LTD dat het toestel Immobilizer for Motor Cycle (SZ137) in overeenstemming is met de essentiële eisen en de andere relevante bepalingen van richtlijn 1999/5/EG.

ASAHI DENSO CO., LTD declara que este Immobilizer for Motor Cycle (SZ137) está conforme con os requisitos essenciais e outras disposições da Directiva 1999/5/CE.

ASAHI DENSO CO., LTD vakuuttaa läten että Immobilizer for Motor Cycle (SZ137) täyttää kaikki direktiivissä 1999/5/EE'ä koskevat vaatimukset ja sillä koskevat asetukset muuten etohtojen mukainen.

Härmed intygar ASAHI DENSO CO., LTD att denna Immobilizer for Motor Cycle (SZ137) står i överensstämmelse med de väsentliga kraven och övriga relevanta bestämmelser som framgår av direktiv 1999/5/EC.

Hér með lýsir ASAHI DENSO CO., LTD yfir því að Immobilizer for Motor Cycle (SZ137) er í samræmi við grunndráttur og aðrar kröfur, sem gerdar eru í tilskilpun 1999/5/EC.

ASAHI DENSO CO., LTD erklærer herved at udstyret Immobilizer for Motor Cycle (SZ137) er i samsvar med de grundlæggende krav og øvrige relevante krav i direktiv 1999/5/EF.







* 9 9 0 1 1 - 0 4 K 5 0 - 0 1 A *

SUZUKI MOTOR CORPORATION

Part No. 99011-04K50-01A February, 2015 EN (TK)

© COPYRIGHT SUZUKI MOTOR CORPORATION 2015

L6

Printed in Japan