



 Read this manual carefully before operating this vehicle.

OWNER'S MANUAL



*Star*

**XVS950AY**

27B-28199-20

 **Read this manual carefully before operating this vehicle. This manual should stay with this vehicle if it is sold.**

Welcome to the Yamaha world of motorcycling!

As the owner of the XVS950AY, you are benefiting from Yamaha's vast experience and newest technology regarding the design and manufacture of high-quality products, which have earned Yamaha a reputation for dependability.

Please take the time to read this manual thoroughly, so as to enjoy all advantages of your XVS950AY. The Owner's Manual does not only instruct you in how to operate, inspect and maintain your motorcycle, but also in how to safeguard yourself and others from trouble and injury.

In addition, the many tips given in this manual will help keep your motorcycle in the best possible condition. If you have any further questions, do not hesitate to contact your Yamaha dealer.

The Yamaha team wishes you many safe and pleasant rides. So, remember to put safety first!

Yamaha continually seeks advancements in product design and quality. Therefore, while this manual contains the most current product information available at the time of printing, there may be minor discrepancies between your motorcycle and this manual. If there is any question concerning this manual, please consult a Yamaha dealer.



---

**Please read this manual carefully and completely before operating this motorcycle.**

---



# IMPORTANT MANUAL INFORMATION

---

---

EAU10132

Particularly important information is distinguished in this manual by the following notations:

	<b>This is the safety alert symbol. It is used to alert you to potential personal injury hazards. Obey all safety messages that follow this symbol to avoid possible injury or death.</b>
	<b>A WARNING indicates a hazardous situation which, if not avoided, could result in death or serious injury.</b>
<b>NOTICE</b>	<b>A NOTICE indicates special precautions that must be taken to avoid damage to the vehicle or other property.</b>
<b>TIP</b>	A TIP provides key information to make procedures easier or clearer.

# **IMPORTANT MANUAL INFORMATION**

---

---

EAU10200

**XVS950AY  
OWNER'S MANUAL  
©2008 by Yamaha Motor Co., Ltd.  
1st edition, September 2008  
All rights reserved.  
Any reprinting or unauthorized use  
without the written permission of  
Yamaha Motor Co., Ltd.  
is expressly prohibited.  
Printed in Japan.**

# TABLE OF CONTENTS

---

---

<b>LOCATION OF IMPORTANT LABELS</b> .....	1-1	<b>FOR YOUR SAFETY – PRE-OPERATION CHECKS</b> .....	5-1	Adjusting the clutch lever free play .....	7-14
<b>SAFETY INFORMATION</b> .....	2-1	<b>OPERATION AND IMPORTANT RIDING POINTS</b> .....	6-1	Adjusting the brake lever free play .....	7-15
<b>DESCRIPTION</b> .....	3-1	Starting the engine .....	6-1	Adjusting the rear brake light switch .....	7-16
Left view .....	3-1	Shifting .....	6-2	Checking the front and rear brake pads .....	7-16
Right view .....	3-2	Tips for reducing fuel consumption .....	6-3	Checking the brake fluid level .....	7-17
Controls and instruments .....	3-3	Engine break-in .....	6-3	Changing the brake fluid .....	7-18
<b>INSTRUMENT AND CONTROL FUNCTIONS</b> .....	4-1	Parking .....	6-4	Drive belt slack .....	7-18
Immobilizer system .....	4-1	<b>PERIODIC MAINTENANCE AND ADJUSTMENT</b> .....	7-1	Checking and lubricating the cables .....	7-20
Main switch/steering lock .....	4-2	Owner's tool kit .....	7-1	Checking and lubricating the throttle grip and cable .....	7-20
Indicator and warning lights .....	4-3	Periodic maintenance chart for the emission control system .....	7-2	Checking and lubricating the brake and shift pedals .....	7-21
Multi-function meter unit .....	4-4	General maintenance and lubrication chart .....	7-3	Checking and lubricating the brake and clutch levers .....	7-21
Handlebar switches .....	4-7	Removing and installing the panel .....	7-6	Checking and lubricating the sidestand .....	7-22
Clutch lever .....	4-9	Checking the spark plugs .....	7-6	Lubricating the rear suspension .....	7-22
Shift pedal .....	4-9	Engine oil and oil filter cartridge .....	7-7	Checking the front fork .....	7-23
Brake lever .....	4-10	Replacing the air filter element .....	7-11	Checking the steering .....	7-23
Brake pedal .....	4-10	Checking the engine idling speed .....	7-11	Checking the wheel bearings .....	7-24
Fuel tank cap .....	4-10	Checking the throttle cable free play .....	7-12	Battery .....	7-24
Fuel .....	4-11	Valve clearance .....	7-12	Replacing the fuses .....	7-26
Catalytic converter .....	4-12	Tires .....	7-12	Replacing the headlight bulb .....	7-27
Rider seat .....	4-13	Cast wheels .....	7-14	Replacing the tail/brake light bulb .....	7-28
Helmet holder .....	4-14				
Adjusting the shock absorber assembly .....	4-14				
Sidestand .....	4-16				
Ignition circuit cut-off system .....	4-16				

# TABLE OF CONTENTS

---

---

Replacing a turn signal light bulb .....	7-29
Replacing a license plate light bulb .....	7-30
Replacing an auxiliary light bulb ....	7-31
Supporting the motorcycle .....	7-31
Troubleshooting .....	7-32
Troubleshooting chart .....	7-33

## **MOTORCYCLE CARE AND**

<b>STORAGE</b> .....	8-1
Matte color caution .....	8-1
Care .....	8-1
Storage .....	8-3

<b>SPECIFICATIONS</b> .....	9-1
-----------------------------	-----

<b>CONSUMER INFORMATION</b> .....	10-1
Identification numbers .....	10-1
Motorcycle noise regulation (for Australia) .....	10-2

# LOCATION OF IMPORTANT LABELS

---

---

EAU10383

Read and understand all of the labels on your vehicle. They contain important information for safe and proper operation of your vehicle. Never remove any labels from your vehicle. If a label becomes difficult to read or comes off, a replacement label is available from your Yamaha dealer.

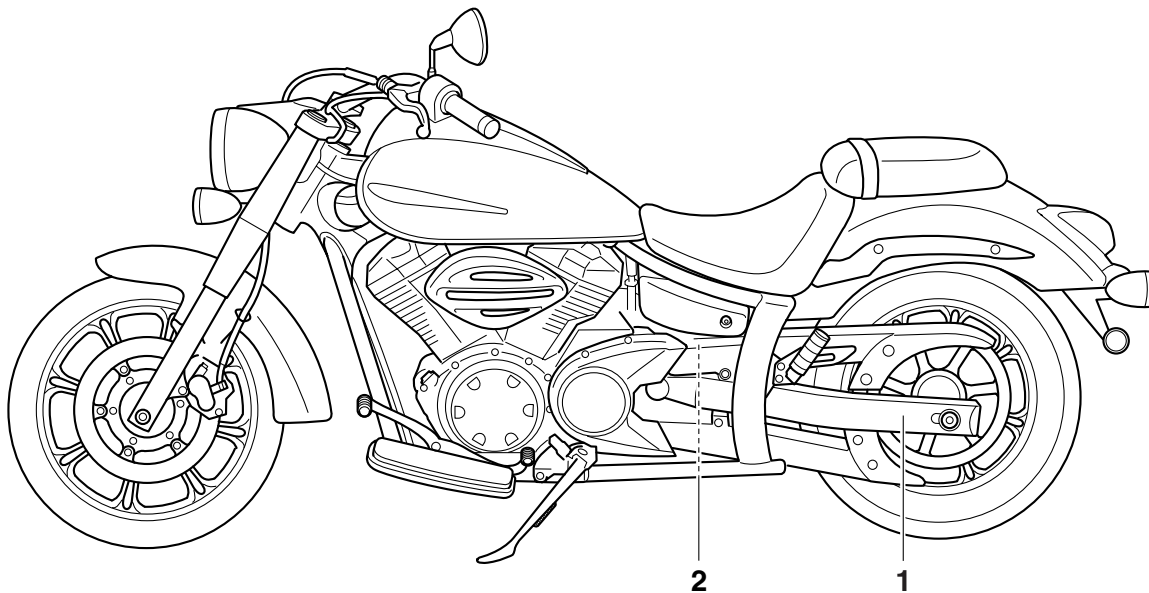



# LOCATION OF IMPORTANT LABELS

1

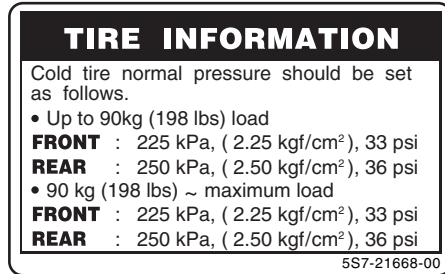

1

2



# LOCATION OF IMPORTANT LABELS

---

---

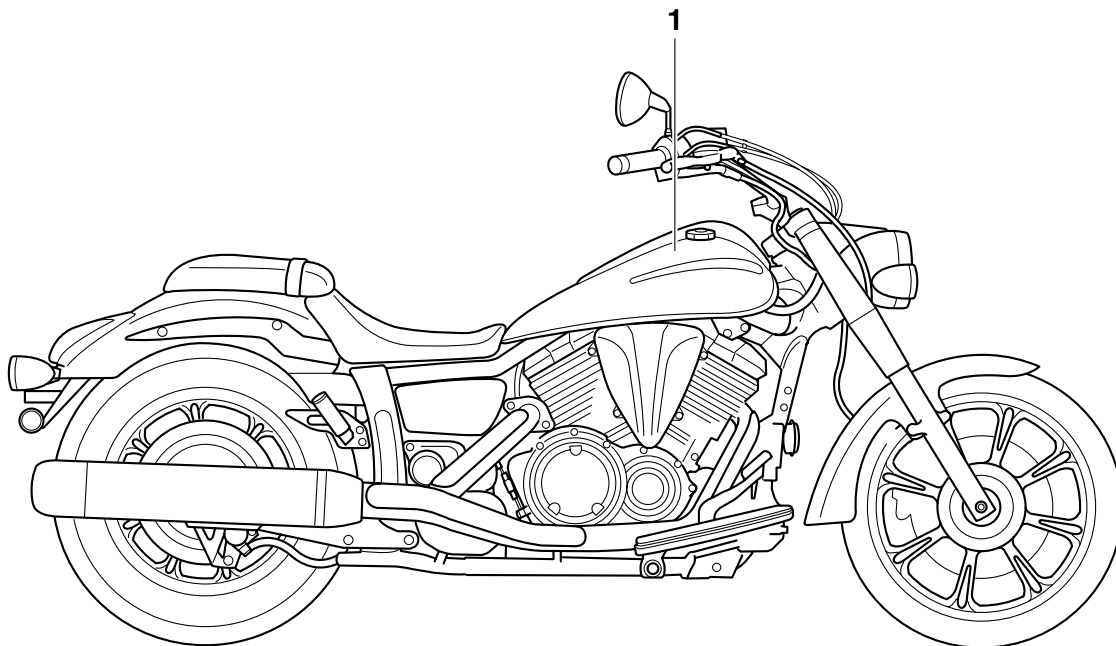

1

# LOCATION OF IMPORTANT LABELS

1

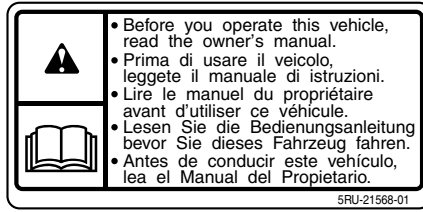

1

# SAFETY INFORMATION

EAU10283

## Be a Responsible Owner

As the vehicle's owner, you are responsible for the safe and proper operation of your motorcycle.

Motorcycles are single-track vehicles. Their safe use and operation are dependent upon the use of proper riding techniques as well as the expertise of the operator. Every operator should know the following requirements before riding this motorcycle.

He or she should:

- Obtain thorough instructions from a competent source on all aspects of motorcycle operation.
- Observe the warnings and maintenance requirements in this Owner's Manual.
- Obtain qualified training in safe and proper riding techniques.
- Obtain professional technical service as indicated in this Owner's Manual and/or when made necessary by mechanical conditions.

## Safe Riding

Perform the pre-operation checks each

time you use the vehicle to make sure it is in safe operating condition. Failure to inspect or maintain the vehicle properly increases the possibility of an accident or equipment damage. See page 5-1 for a list of pre-operation checks.

- This motorcycle is designed to carry the operator and a passenger.
- The failure of motorists to detect and recognize motorcycles in traffic is the predominating cause of automobile/motorcycle accidents. Many accidents have been caused by an automobile driver who did not see the motorcycle. Making yourself conspicuous appears to be very effective in reducing the chance of this type of accident.

### Therefore:

- Wear a brightly colored jacket.
- Use extra caution when you are approaching and passing through intersections, since intersections are the most likely places for motorcycle accidents to occur.
- Ride where other motorists can see you. Avoid riding in another

motorist's blind spot.

- Many accidents involve inexperienced operators. In fact, many operators who have been involved in accidents do not even have a current motorcycle license.
  - Make sure that you are qualified and that you only lend your motorcycle to other qualified operators.
  - Know your skills and limits. Staying within your limits may help you to avoid an accident.
  - We recommend that you practice riding your motorcycle where there is no traffic until you have become thoroughly familiar with the motorcycle and all of its controls.
- Many accidents have been caused by error of the motorcycle operator. A typical error made by the operator is veering wide on a turn due to excessive speed or undercornering (insufficient lean angle for the speed).
  - Always obey the speed limit and never travel faster than warrant-

ed by road and traffic conditions.

- Always signal before turning or changing lanes. Make sure that other motorists can see you.
- The posture of the operator and passenger is important for proper control.
- The operator should keep both hands on the handlebar and both feet on the operator footrests during operation to maintain control of the motorcycle.
- The passenger should always hold onto the operator, the seat strap or grab bar, if equipped, with both hands and keep both feet on the passenger footrests. Never carry a passenger unless he or she can firmly place both feet on the passenger footrests.
- Never ride under the influence of alcohol or other drugs.
- This motorcycle is designed for on-road use only. It is not suitable for off-road use.

### **Protective apparel**

The majority of fatalities from motorcy-

cle accidents are the result of head injuries. The use of a safety helmet is the single most critical factor in the prevention or reduction of head injuries.

- Always wear an approved helmet.
- Wear a face shield or goggles. Wind in your unprotected eyes could contribute to an impairment of vision that could delay seeing a hazard.
- The use of a jacket, heavy boots, trousers, gloves, etc., is effective in preventing or reducing abrasions or lacerations.
- Never wear loose-fitting clothes, otherwise they could catch on the control levers, footrests, or wheels and cause injury or an accident.
- Always wear protective clothing that covers your legs, ankles, and feet. The engine or exhaust system become very hot during or after operation and can cause burns.
- A passenger should also observe the above precautions.

### **Avoid Carbon Monoxide Poisoning**

All engine exhaust contains carbon

monoxide, a deadly gas. Breathing carbon monoxide can cause headaches, dizziness, drowsiness, nausea, confusion, and eventually death.

Carbon Monoxide is a colorless, odorless, tasteless gas which may be present even if you do not see or smell any engine exhaust. Deadly levels of carbon monoxide can collect rapidly and you can quickly be overcome and unable to save yourself. Also, deadly levels of carbon monoxide can linger for hours or days in enclosed or poorly ventilated areas. If you experience any symptoms of carbon monoxide poisoning, leave the area immediately, get fresh air, and **SEEK MEDICAL TREATMENT.**

- Do not run engine indoors. Even if you try to ventilate engine exhaust with fans or open windows and doors, carbon monoxide can rapidly reach dangerous levels.
- Do not run engine in poorly ventilated or partially enclosed areas such as barns, garages, or carports.
- Do not run engine outdoors where

# SAFETY INFORMATION

engine exhaust can be drawn into a building through openings such as windows and doors.

## Loading

Adding accessories or cargo to your motorcycle can adversely affect stability and handling if the weight distribution of the motorcycle is changed. To avoid the possibility of an accident, use extreme caution when adding cargo or accessories to your motorcycle. Use extra care when riding a motorcycle that has added cargo or accessories. Here, along with the information about accessories below, are some general guidelines to follow if loading cargo to your motorcycle:

The total weight of the operator, passenger, accessories and cargo must not exceed the maximum load limit.

**Operation of an overloaded vehicle could cause an accident.**

**Maximum load:**  
210 kg (463 lb)

When loading within this weight limit, keep the following in mind:

- Cargo and accessory weight should be kept as low and close to the motorcycle as possible. Securely pack your heaviest items as close to the center of the vehicle as possible and make sure to distribute the weight as evenly as possible on both sides of the motorcycle to minimize imbalance or instability.
- Shifting weights can create a sudden imbalance. Make sure that accessories and cargo are securely attached to the motorcycle before riding. Check accessory mounts and cargo restraints frequently.
  - Properly adjust the suspension for your load (suspension-adjustable models only), and check the condition and pressure of your tires.
  - Never attach any large or heavy items to the handlebar, front fork, or front fender. These items, including such cargo as sleeping bags, duffel bags, or tents, can create unstable han-

dling or a slow steering response.

- **This vehicle is not designed to pull a trailer or to be attached to a sidecar.**

## Genuine Yamaha Accessories

Choosing accessories for your vehicle is an important decision. Genuine Yamaha accessories, which are available only from a Yamaha dealer, have been designed, tested, and approved by Yamaha for use on your vehicle.

Many companies with no connection to Yamaha manufacture parts and accessories or offer other modifications for Yamaha vehicles. Yamaha is not in a position to test the products that these aftermarket companies produce. Therefore, Yamaha can neither endorse nor recommend the use of accessories not sold by Yamaha or modifications not specifically recommended by Yamaha, even if sold and installed by a Yamaha dealer.

### **Aftermarket Parts, Accessories, and Modifications**

While you may find aftermarket products similar in design and quality to genuine Yamaha accessories, recognize that some aftermarket accessories or modifications are not suitable because of potential safety hazards to you or others. Installing aftermarket products or having other modifications performed to your vehicle that change any of the vehicle's design or operation characteristics can put you and others at greater risk of serious injury or death. You are responsible for injuries related to changes in the vehicle.

Keep the following guidelines in mind, as well as those provided under "Loading" when mounting accessories.

- Never install accessories or carry cargo that would impair the performance of your motorcycle. Carefully inspect the accessory before using it to make sure that it does not in any way reduce ground clearance or cornering clearance, limit suspension travel, steering travel or control operation, or ob-

scure lights or reflectors.

- Accessories fitted to the handlebar or the front fork area can create instability due to improper weight distribution or aerodynamic changes. If accessories are added to the handlebar or front fork area, they must be as lightweight as possible and should be kept to a minimum.
- Bulky or large accessories may seriously affect the stability of the motorcycle due to aerodynamic effects. Wind may attempt to lift the motorcycle, or the motorcycle may become unstable in cross winds. These accessories may also cause instability when passing or being passed by large vehicles.
- Certain accessories can displace the operator from his or her normal riding position. This improper position limits the freedom of movement of the operator and may limit control ability, therefore, such accessories are not recommended.

- Use caution when adding electrical accessories. If electrical accessories exceed the capacity of the motorcycle's electrical system, an electric failure could result, which could cause a dangerous loss of lights or engine power.

### **Aftermarket Tires and Rims**

The tires and rims that came with your motorcycle were designed to match the performance capabilities and to provide the best combination of handling, braking, and comfort. Other tires, rims, sizes, and combinations may not be appropriate. Refer to page 7-12 for tire specifications and more information on replacing your tires.

# DESCRIPTION

EAU10410

## Left view

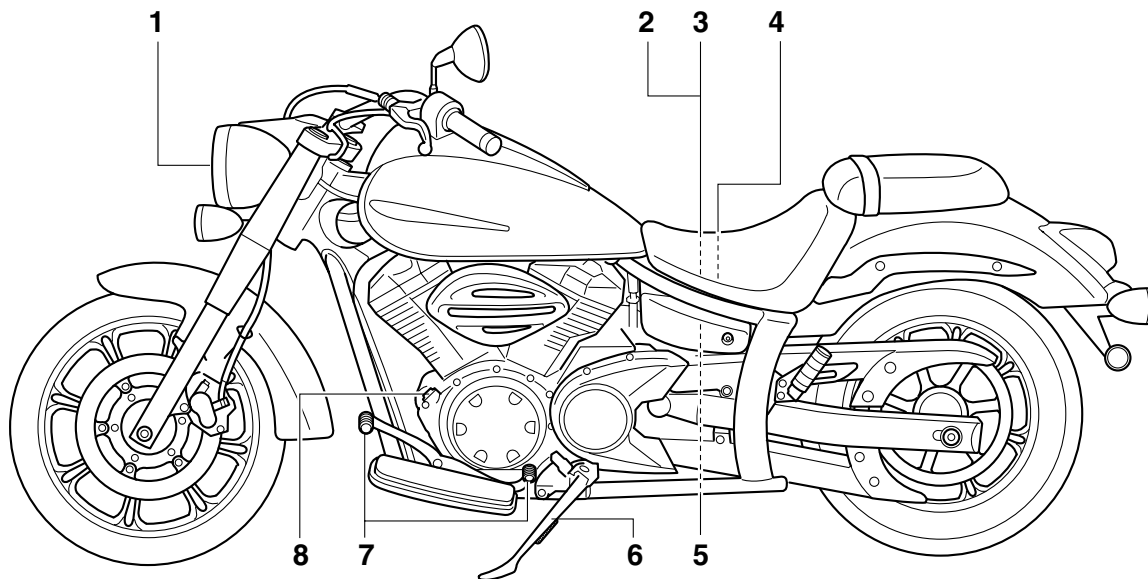

1. Headlight (page 7-27)
2. Fuses (page 7-26)
3. Owner's tool kit (page 7-1)
4. Battery (page 7-24)
5. Shock absorber assembly spring preload adjusting ring (page 4-14)
6. Sidestand (page 4-16)
7. Shift pedal (page 4-9)
8. Engine oil filler cap (page 7-7)



## Right view

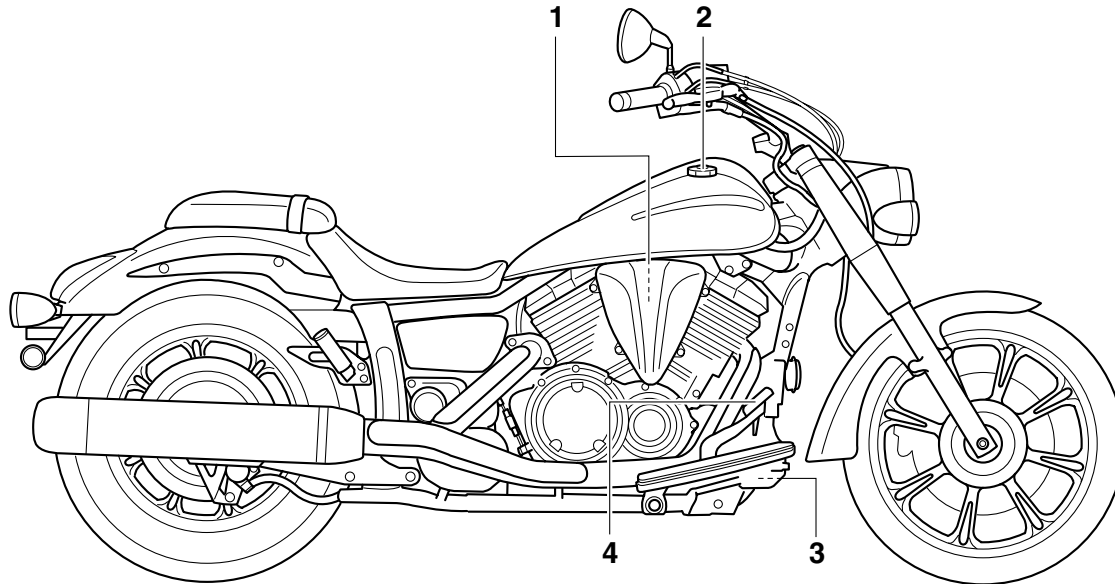

1. Air filter element (page 7-11)
2. Fuel tank cap (page 4-10)
3. Engine oil filter cartridge (page 7-7)
4. Brake pedal (page 4-10)

# DESCRIPTION

EAU10430

## Controls and instruments

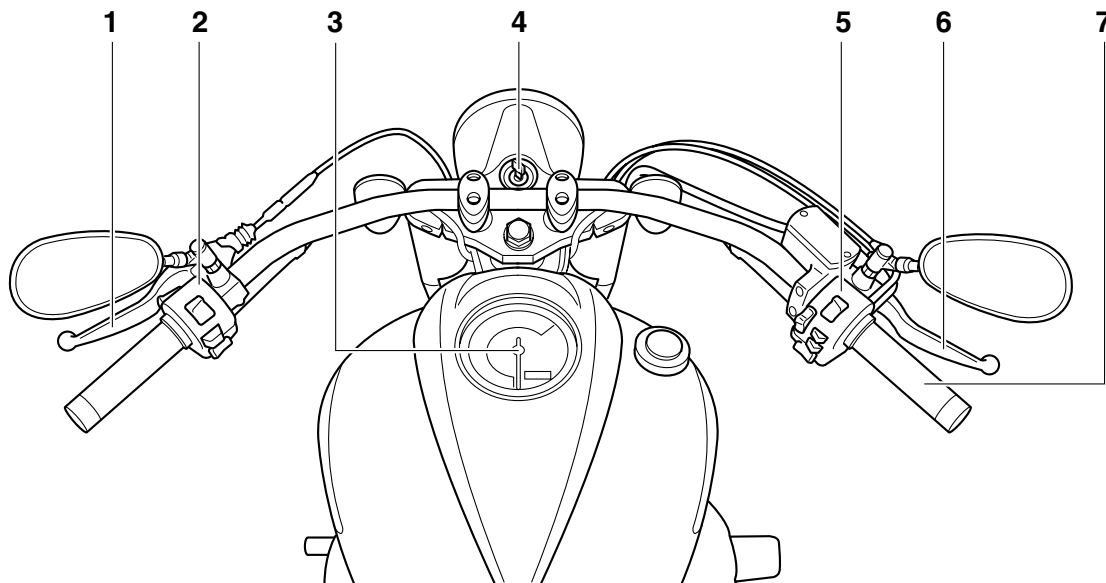

1. Clutch lever (page 4-9)
2. Left handlebar switches (page 4-7)
3. Multi-function meter unit (page 4-4)
4. Main switch/steering lock (page 4-2)
5. Right handlebar switches (page 4-7)
6. Brake lever (page 4-10)
7. Throttle grip (page 7-12)

## Immobilizer system

EAU10975

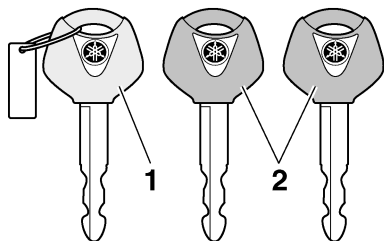

1. Code re-registering key (red bow)
2. Standard keys (black bow)

This vehicle is equipped with an immobilizer system to help prevent theft by re-registering codes in the standard keys. This system consists of the following:

- a code re-registering key (with a red bow)
- two standard keys (with a black bow) that can be re-registered with new codes
- a transponder (which is installed in the code re-registering key)
- an immobilizer unit
- an ECU (Electronic Control Unit)

- an immobilizer system indicator light (See page 4-3.)
- The key with the red bow is used to register codes in each standard key. Since re-registering is a difficult process, take the vehicle along with all three keys to a Yamaha dealer to have them re-registered. Do not use the key with the red bow for driving. It should only be used for re-registering the standard keys. Always use a standard key for driving.

ECA11821

### NOTICE

- **DO NOT LOSE THE CODE RE-REGISTERING KEY! CONTACT YOUR DEALER IMMEDIATELY IF IT IS LOST! If the code re-registering key is lost, registering new codes in the standard keys is impossible. The standard keys can still be used to start the vehicle, however if code re-registering is required (i.e., if a new standard key is made or all keys are lost) the entire immobilizer system must be replaced. Therefore, it is highly recommended to use either standard key and keep the code**

re-registering key in a safe place.

- Do not submerge any key in water.
- Do not expose any key to excessively high temperatures.
- Do not place any key close to magnets (this includes, but not limited to, products such as speakers, etc.).
- Do not place items that transmit electrical signals close to any key.
- Do not place heavy items on any key.
- Do not grind any key or alter its shape.
- Do not disassemble the plastic part of any key.
- Do not put two keys of any immobilizer system on the same key ring.
- Keep the standard keys as well as keys of other immobilizer systems away from this vehicle's code re-registering key.
- Keep other immobilizer system keys away from the main switch

# INSTRUMENT AND CONTROL FUNCTIONS

as they may cause signal interference.

## Main switch/steering lock

EAU10460

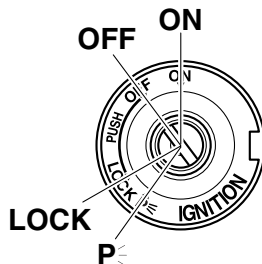

The main switch/steering lock controls the ignition and lighting systems, and is used to lock the steering. The various positions are described below.

### ON

EAU38530

All electrical circuits are supplied with power; the meter lighting, taillight, license plate light and auxiliary light come on, and the engine can be started. The key cannot be removed.

### TIP

The headlight comes on automatically when the engine is started and stays on until the key is turned to “OFF”, even if

the engine stalls.

EAU10661

### OFF

All electrical systems are off. The key can be removed.

EWA10061

### **WARNING**

Never turn the key to “OFF” or “LOCK” while the vehicle is moving. Otherwise the electrical systems will be switched off, which may result in loss of control or an accident.

EAU10681

### LOCK

The steering is locked, and all electrical systems are off. The key can be removed.

#### To lock the steering

1. Turn the handlebars all the way to the left.
2. Push the key in from the “OFF” position, and then turn it to “LOCK” while still pushing it.
3. Remove the key.

# INSTRUMENT AND CONTROL FUNCTIONS

## To unlock the steering

Push the key in, and then turn it to “OFF” while still pushing it.

EAU34341

## P<sub>⊆</sub> (Parking)

The steering is locked, and the taillight, license plate light and auxiliary light are on. The hazard lights and turn signal lights can be turned on, but all other electrical systems are off. The key can be removed.

The steering must be locked before the key can be turned to “P<sub>⊆</sub>”.

ECA11020





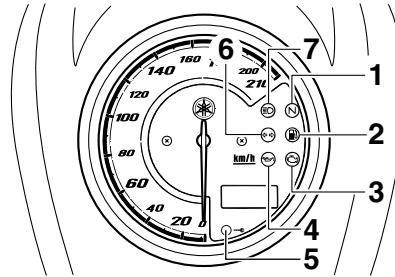

## NOTICE

**Do not use the parking position for an extended length of time, otherwise the battery may discharge.**

## Indicator and warning lights

EAU11003



1. Neutral indicator light “N”
2. Fuel level warning light “”
3. Engine trouble warning light “”
4. Oil level warning light “”
5. Immobilizer system indicator light “”
6. Turn signal indicator light “ ”
7. High beam indicator light “”

EAU11020

## Turn signal indicator light “ ”

This indicator light flashes when the turn signal switch is pushed to the left or right.

## Neutral indicator light “N”

EAU11060

This indicator light comes on when the transmission is in the neutral position.

EAU11080

## High beam indicator light “”

This indicator light comes on when the high beam of the headlight is switched on.

EAU11121

## Oil level warning light “”

This warning light comes on if the engine oil level is low.

The electrical circuit of the warning light can be checked by turning the key to “ON”.

If the warning light does not come on for a few seconds, then go off, have a Yamaha dealer check the electrical circuit.

## TIP

Even if the oil level is sufficient, the warning light may flicker when riding on a slope or during sudden acceleration or deceleration, but this is not a malfunction.

# INSTRUMENT AND CONTROL FUNCTIONS

EAU11350

## Fuel level warning light “”

This warning light comes on when the fuel level drops below approximately 3.0 L (0.79 US gal, 0.66 Imp.gal). When this occurs, refuel as soon as possible. The electrical circuit of the warning light can be checked by turning the key to “ON”.

If the warning light does not come on for a few seconds, then go off, have a Yamaha dealer check the electrical circuit.

EAU46440

## Engine trouble warning light “”

This warning light comes on if a problem is detected in the electrical circuit monitoring the engine. If this occurs, have a Yamaha dealer check the self-diagnosis system. (See page 4-6 for an explanation of the self-diagnosis device.)

The electrical circuit of the warning light can be checked by turning the key to “ON”. If the warning light does not come on for a few seconds, then go off, have a Yamaha dealer check the electrical circuit.

## TIP

This warning light will come on when the key is turned to “ON” and the start switch is pushed, but this does not indicate a malfunction.

EAU38621

## Immobilizer system indicator light

The electrical circuit of the indicator light can be checked by turning the key to “ON”.

If the indicator light does not come on for a few seconds, then go off, have a Yamaha dealer check the electrical circuit.

When the key is turned to “OFF” and 30 seconds have passed, the indicator light will start flashing indicating the immobilizer system is enabled. After 24 hours have passed, the indicator light will stop flashing, however the immobilizer system is still enabled.

This model is also equipped with a self-diagnosis device for the immobilizer system. (See page 4-6 for an explanation of the self-diagnosis device.)

EAU47200

## Multi-function meter unit

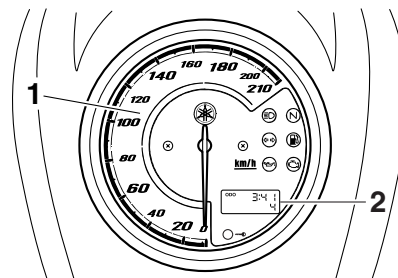

1. Speedometer
2. Odometer/tripmeters/fuel reserve tripmeter/clock

EWA12422

## WARNING

**Be sure to stop the vehicle before making any setting changes to the multi-function meter unit. Changing settings while riding can distract the operator and increase the risk of an accident.**

The multi-function meter unit is equipped with the following:

- a speedometer
- an odometer
- two tripmeters (which show the

# INSTRUMENT AND CONTROL FUNCTIONS

distance traveled since they were last set to zero)

- a fuel reserve tripmeter (which shows the distance traveled on the fuel reserve)
- a clock
- a self-diagnosis device
- a brightness control mode

## TIP

Be sure to turn the key to “ON” before using the “SELECT” and “RESET” switches, except for setting the brightness control mode.

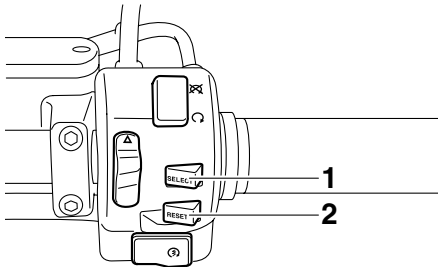

1. “SELECT” switch
2. “RESET” switch

## Speedometer

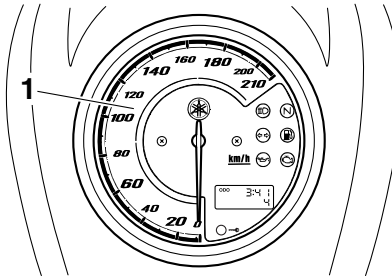

1. Speedometer

When the key is turned to “ON”, the speedometer needle will sweep once across the speed range and then return to zero in order to test the electrical circuit.

## Odometer, tripmeters, fuel reserve tripmeter and clock

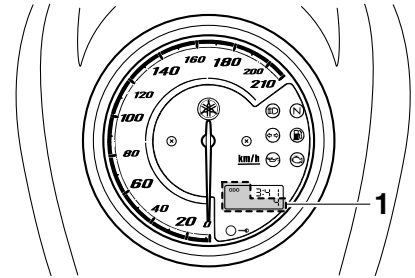

1. Odometer/tripmeters/fuel reserve tripmeter

Push the “SELECT” switch to change the display between the odometer mode “ODO”, the tripmeter modes “TRIP A” and “TRIP B” in the following order:

ODO → TRIP A → TRIP B → ODO

If the fuel level warning light comes on (see page 4-3), the odometer display will automatically change to the fuel reserve tripmeter mode “TRIP F” and start counting the distance traveled from that point. In that case, push the “SELECT” switch to change the display between the various tripmeter and

# INSTRUMENT AND CONTROL FUNCTIONS

odometer modes in the following order:  
TRIP F → TRIP A → TRIP B → ODO  
→ TRIP F

To reset a tripmeter, select it by pushing the “SELECT” switch, and then push the “RESET” switch for at least one second. If you do not reset the fuel reserve tripmeter manually, it will reset itself automatically, and the display will return to the prior mode after refueling and traveling 5 km (3 mi).

To set the clock:

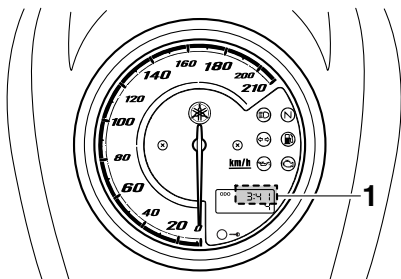

1. Clock

1. Push the “SELECT” and “RESET” switches together for at least three seconds.
2. When the hour digits start flashing,

push the “RESET” switch to set the hours.

3. Push the “SELECT” switch, and the minute digits will start flashing.
4. Push the “RESET” switch to set the minutes.
5. Push the “SELECT” switch and then release it to start the clock.

## Self-diagnosis device

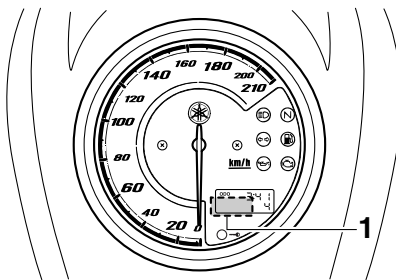

1. Error code display

This model is equipped with a self-diagnosis device for various electrical circuits.

If a problem is detected in any of those circuits, the engine trouble warning light will come on and the odometer/tripmeter/clock display will indicate an error

code.

The self-diagnosis device also detects problems in the immobilizer system circuits.

If a problem is detected in the immobilizer system circuits, the immobilizer system indicator light will flash and the display will indicate an error code.

## TIP

If the display indicates error code 52, this could be caused by transponder interference. If this error code appears, try the following.

1. Use the code re-registering key to start the engine.

## TIP

Make sure there are no other immobilizer keys close to the main switch, and do not keep more than one immobilizer key on the same key ring! Immobilizer system keys may cause signal interference, which may prevent the engine from starting.

2. If the engine starts, turn it off and try starting the engine with the standard keys.
3. If one or both of the standard keys



# INSTRUMENT AND CONTROL FUNCTIONS

EAU12347

do not start the engine, take the vehicle, the code re-registering key and both standard keys to a Yamaha dealer and have the standard keys re-registered.

If the odometer/tripmeter/clock display indicates any error codes, note the code number, and then have a Yamaha dealer check the vehicle.

ECA11590

## NOTICE

**If the display indicates an error code, the vehicle should be checked as soon as possible in order to avoid engine damage.**

## Brightness control mode

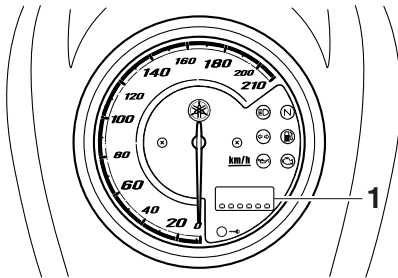

1. Brightness level

This function allows you to adjust the brightness of the multi-function meter unit panel to suit the outside lighting conditions.

## To set the brightness

1. Turn the key to "OFF".
2. Push and hold the "SELECT" switch.
3. Turn the key to "ON", and then release the "SELECT" switch after five seconds.
4. Adjust the multi-function meter unit panel brightness level by pushing the "SELECT" switch.
5. Push the "RESET" switch.

The odometer/tripmeter/clock display will return to the prior mode.

## Handlebar switches

### Left

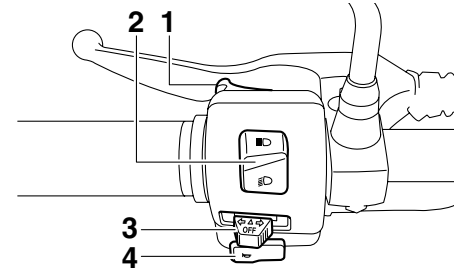

1. Pass switch "≡O"
2. Dimmer switch "≡O/≡O"
3. Turn signal switch "←/→"
4. Horn switch "🔊"

# INSTRUMENT AND CONTROL FUNCTIONS

## Right

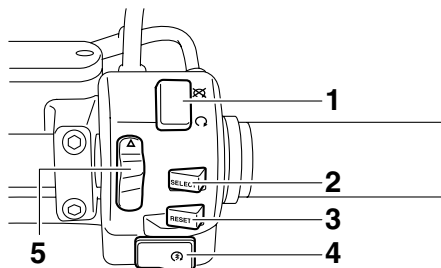

1. Engine stop switch “/”
2. “SELECT” switch
3. “RESET” switch
4. Start switch “”
5. Hazard switch “”

EAU12350

## Pass switch “/”

Press this switch to flash the headlight.

EAU12400

## Dimmer switch “/”

Set this switch to “” for the high beam and to “” for the low beam.

EAU12460

## Turn signal switch “/”

To signal a right-hand turn, push this switch to “”. To signal a left-hand

turn, push this switch to “”. When released, the switch returns to the center position. To cancel the turn signal lights, push the switch in after it has returned to the center position.

EAU12500

## Horn switch “”

Press this switch to sound the horn.

EAU12660

## Engine stop switch “/”

Set this switch to “” before starting the engine. Set this switch to “” to stop the engine in case of an emergency, such as when the vehicle overturms or when the throttle cable is stuck.

EAU12711

## Start switch “”

Push this switch to crank the engine with the starter. See page 6-1 for starting instructions prior to starting the engine.

EAU41700

The engine trouble warning light will come on when the key is turned to “ON”

and the start switch is pushed, but this does not indicate a malfunction.

EAU12733

## Hazard switch “”

With the key in the “ON” or “p<sub>ε</sub>” position, use this switch to turn on the hazard lights (simultaneous flashing of all turn signal lights).

The hazard lights are used in case of an emergency or to warn other drivers when your vehicle is stopped where it might be a traffic hazard.

ECA10061

## NOTICE

**Do not use the hazard lights for an extended length of time with the engine not running, otherwise the battery may discharge.**

EAU44600

## “SELECT” switch

This switch is used to perform selections in the odometer, tripmeter, to set the clock and to set the brightness mode of the multi-function meter unit. See “Multi-function meter unit” on page 4-4 for detailed information.

# INSTRUMENT AND CONTROL FUNCTIONS

## “RESET” switch

This switch is used to perform selections in the tripmeter, to set the clock, and to set the brightness mode of the multi-function meter unit.

See “Multi-function meter unit” on page 4-4 for detailed information.

EAU42532

## Clutch lever

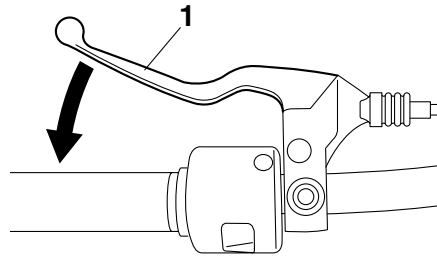

1. Clutch lever

The clutch lever is located at the left handlebar grip. To disengage the clutch, pull the lever toward the handlebar grip. To engage the clutch, release the lever. The lever should be pulled rapidly and released slowly for smooth clutch operation.

The clutch lever is equipped with a clutch switch, which is part of the ignition circuit cut-off system. (See page 4-16.)

EAU12820

## Shift pedal

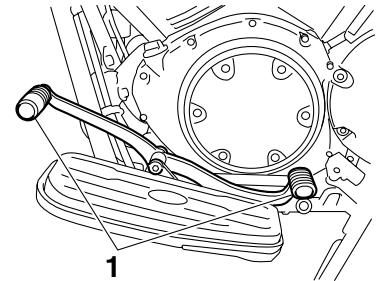

1. Shift pedal

The shift pedal is located on the left side of the engine and is used in combination with the clutch lever when shifting the gears of the 5-speed constant-mesh transmission equipped on this motorcycle.

### TIP

Use your toes or heel to shift up and your toes to shift down.

# INSTRUMENT AND CONTROL FUNCTIONS

EAU12890

## Brake lever

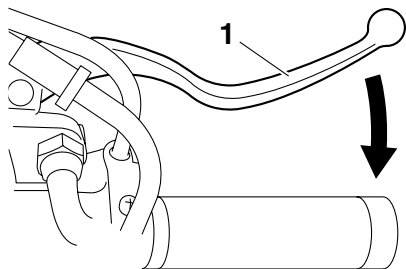

1. Brake lever

The brake lever is located at the right handlebar grip. To apply the front brake, pull the lever toward the handlebar grip.

EAU12941

## Brake pedal

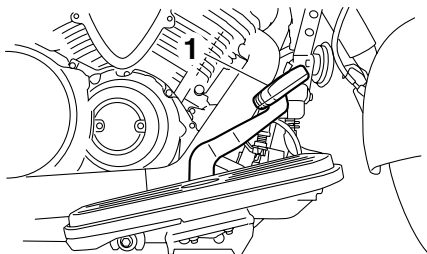

1. Brake pedal

The brake pedal is on the right side of the motorcycle. To apply the rear brake, press down on the brake pedal.

EAU13121

## Fuel tank cap

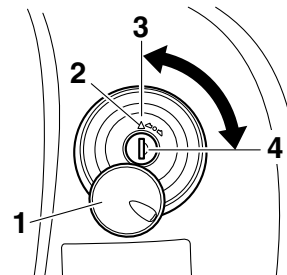

1. Fuel tank cap lock cover
2. “△” mark
3. Lock.
4. Unlock.

### To remove the fuel tank cap

Slide the lock cover open, insert the key into the lock, and then turn it 1/4 turn clockwise. The lock will be released and the fuel tank cap can be removed.

### To install the fuel tank cap

1. Insert the fuel tank cap into the tank opening with the key inserted in the lock and with the “△” mark facing forward.
2. Turn the key counterclockwise to

# INSTRUMENT AND CONTROL FUNCTIONS

the original position, remove it, and then close the lock cover.

## TIP

The fuel tank cap cannot be installed unless the key is in the lock. In addition, the key cannot be removed if the cap is not properly installed and locked.

EWA10131

## WARNING

Make sure that the fuel tank cap is properly installed before riding. Leaking fuel is a fire hazard.

## Fuel

Make sure there is sufficient gasoline in the tank.

EAU13221

EWA10881

## WARNING

Gasoline and gasoline vapors are extremely flammable. To avoid fires and explosions and to reduce the risk of injury when refueling, follow these instructions.

1. Before refueling, turn off the engine and be sure that no one is sitting on the vehicle. Never refuel while smoking, or while in the vicinity of sparks, open flames, or other sources of ignition such as the pilot lights of water heaters and clothes dryers.
2. Do not overfill the fuel tank. When refueling, be sure to insert the pump nozzle into the fuel tank filler hole. Stop filling when the fuel reaches the bottom of the filler tube. Because fuel expands when it heats up, heat from the engine or the sun can cause fuel to spill out of the fuel tank.

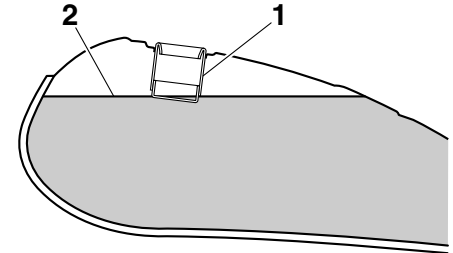

1. Fuel tank filler tube
2. Fuel level

3. Wipe up any spilled fuel immediately. **NOTICE: Immediately wipe off spilled fuel with a clean, dry, soft cloth, since fuel may deteriorate painted surfaces or plastic parts.**<sup>[ECA10071]</sup>
4. Be sure to securely close the fuel tank cap.

EWA15151

## WARNING

Gasoline is poisonous and can cause injury or death. Handle gasoline with care. Never siphon gasoline by mouth. If you should swallow some gasoline or inhale a lot of gasoline vapor, or get some gasoline in

# INSTRUMENT AND CONTROL FUNCTIONS

**your eyes, see your doctor immediately. If gasoline spills on your skin, wash with soap and water. If gasoline spills on your clothing, change your clothes.**

EAU36922

## Recommended fuel:

UNLEADED GASOLINE ONLY

## Fuel tank capacity:

17.0 L (4.49 US gal, 3.74 Imp.gal)

## Fuel reserve amount (when the fuel level warning symbol comes on):

3.0 L (0.79 US gal, 0.66 Imp.gal)

ECA11400

## NOTICE

**Use only unleaded gasoline. The use of leaded gasoline will cause severe damage to internal engine parts, such as the valves and piston rings, as well as to the exhaust system.**

Your Yamaha engine has been designed to use regular unleaded gasoline with a research octane number of 91 or higher. If knocking (or pinging) occurs, use a gasoline of a different brand

or premium unleaded fuel. Use of unleaded fuel will extend spark plug life and reduce maintenance costs.

EAU13433

## Catalytic converter

This model is equipped with a catalytic converter in the exhaust system.

EWA10862

## WARNING

**The exhaust system is hot after operation. To prevent a fire hazard or burns:**

- Do not park the vehicle near possible fire hazards such as grass or other materials that easily burn.
- Park the vehicle in a place where pedestrians or children are not likely to touch the hot exhaust system.
- Make sure that the exhaust system has cooled down before doing any maintenance work.
- Do not allow the engine to idle more than a few minutes. Long idling can cause a build-up of heat.

ECA10701

## NOTICE

**Use only unleaded gasoline. The use of leaded gasoline will cause unre-**

# INSTRUMENT AND CONTROL FUNCTIONS

pairable damage to the catalytic converter.

EAU42750

## Rider seat

### To remove the rider seat

1. Insert the key into the seat lock, and then turn it counterclockwise.

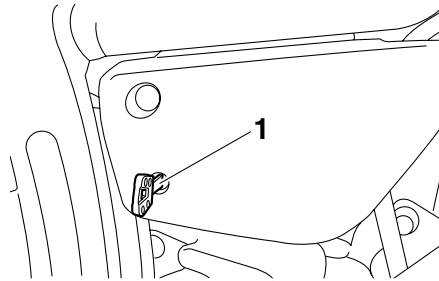

1. Key
2. Lift the front of the seat up, and then pull the seat off.

### To install the rider seat

1. Insert the projection on the rear of the seat into the seat holder as shown.

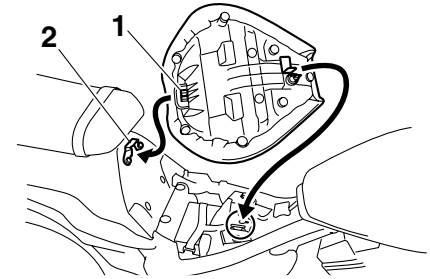

1. Projection
2. Seat holder

2. Push the front of the seat down to lock it in place.
3. Remove the key.

### TIP

Make sure that the seat is properly secured before riding.

# INSTRUMENT AND CONTROL FUNCTIONS

## Helmet holder

EAU14321

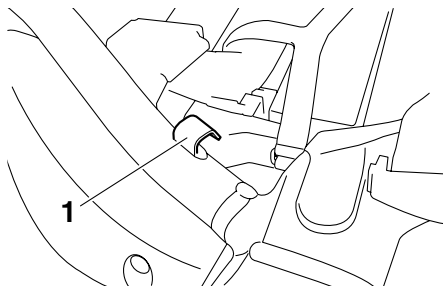

1. Helmet holder

The helmet holder is located under the rider seat.

## To secure a helmet to the helmet holder

1. Remove the rider seat. (See page 4-13.)
2. Attach the helmet to the helmet holder, and then securely install the seat. **WARNING! Never ride with a helmet attached to the helmet holder, since the helmet may hit objects, causing loss of control and possibly an accident.**<sup>[EWA10161]</sup>

## To release the helmet from the helmet holder

Remove the rider seat, remove the helmet from the helmet holder, and then install the seat.

## Adjusting the shock absorber assembly

EAU47160

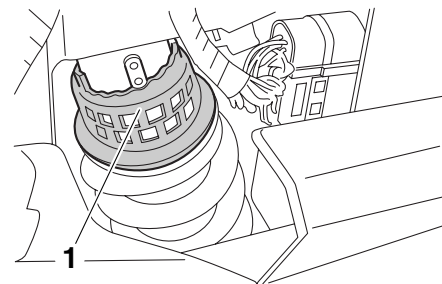

1. Spring preload adjusting ring

This shock absorber assembly is equipped with a spring preload adjusting ring, allowing the spring preload to be adjusted to suit the rider's preference.

It is recommended to have a Yamaha dealer adjust the spring preload.

- Should you choose to make the adjustment, use the special wrench included in the additional tool kit, which was handed out separately at the purchase of the vehicle.



# INSTRUMENT AND CONTROL FUNCTIONS

ECA10101

## NOTICE

To avoid damaging the mechanism, do not attempt to turn beyond the maximum or minimum settings.

Adjust the spring preload as follows.

1. Remove panel A. (See page 7-6.)
2. To increase the spring preload and thereby harden the suspension, turn the adjusting ring in direction (a). To decrease the spring preload and thereby soften the suspension, turn the adjusting ring in direction (b).

## TIP

Align the appropriate notch in the adjusting ring with the position indicator on the shock absorber.

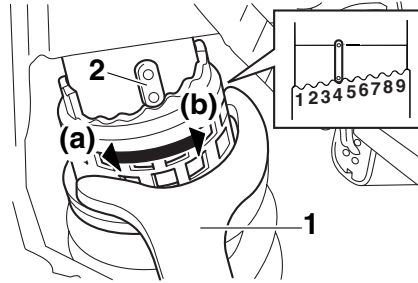

1. Special wrench
2. Position indicator

### Spring preload setting:

Minimum (soft):

1

Standard:

4

Maximum (hard):

9

3. Install the panel.

EWA10221

## WARNING

This shock absorber assembly contains highly pressurized nitrogen gas. Read and understand the following information before handling the shock absorber assembly.

- Do not tamper with or attempt to

open the cylinder assembly.

- Do not subject the shock absorber assembly to an open flame or other high heat source. This may cause the unit to explode due to excessive gas pressure.
- Do not deform or damage the cylinder in any way. Cylinder damage will result in poor damping performance.
- Do not dispose of a damaged or worn-out shock absorber assembly yourself. Take the shock absorber assembly to a Yamaha dealer for any service.

# INSTRUMENT AND CONTROL FUNCTIONS

## Sidestand

EAU15301

The sidestand is located on the left side of the frame. Raise the sidestand or lower it with your foot while holding the vehicle upright.

### TIP

The built-in sidestand switch is part of the ignition circuit cut-off system, which cuts the ignition in certain situations. (See further down for an explanation of the ignition circuit cut-off system.)

EWA10240

### WARNING

**The vehicle must not be ridden with the sidestand down, or if the sidestand cannot be properly moved up (or does not stay up), otherwise the sidestand could contact the ground and distract the operator, resulting in a possible loss of control. Yamaha's ignition circuit cut-off system has been designed to assist the operator in fulfilling the responsibility of raising the sidestand before starting off. Therefore, check this system regularly as described below and have a Yamaha dealer re-**

**pair it if it does not function properly.**

EAU44892

## Ignition circuit cut-off system

The ignition circuit cut-off system (comprising the sidestand switch, clutch switch and neutral switch) has the following functions.

- It prevents starting when the transmission is in gear and the sidestand is up, but the clutch lever is not pulled.
- It prevents starting when the transmission is in gear and the clutch lever is pulled, but the sidestand is still down.
- It cuts the running engine when the transmission is in gear and the sidestand is moved down.

Periodically check the operation of the ignition circuit cut-off system according to the following procedure.

# INSTRUMENT AND CONTROL FUNCTIONS

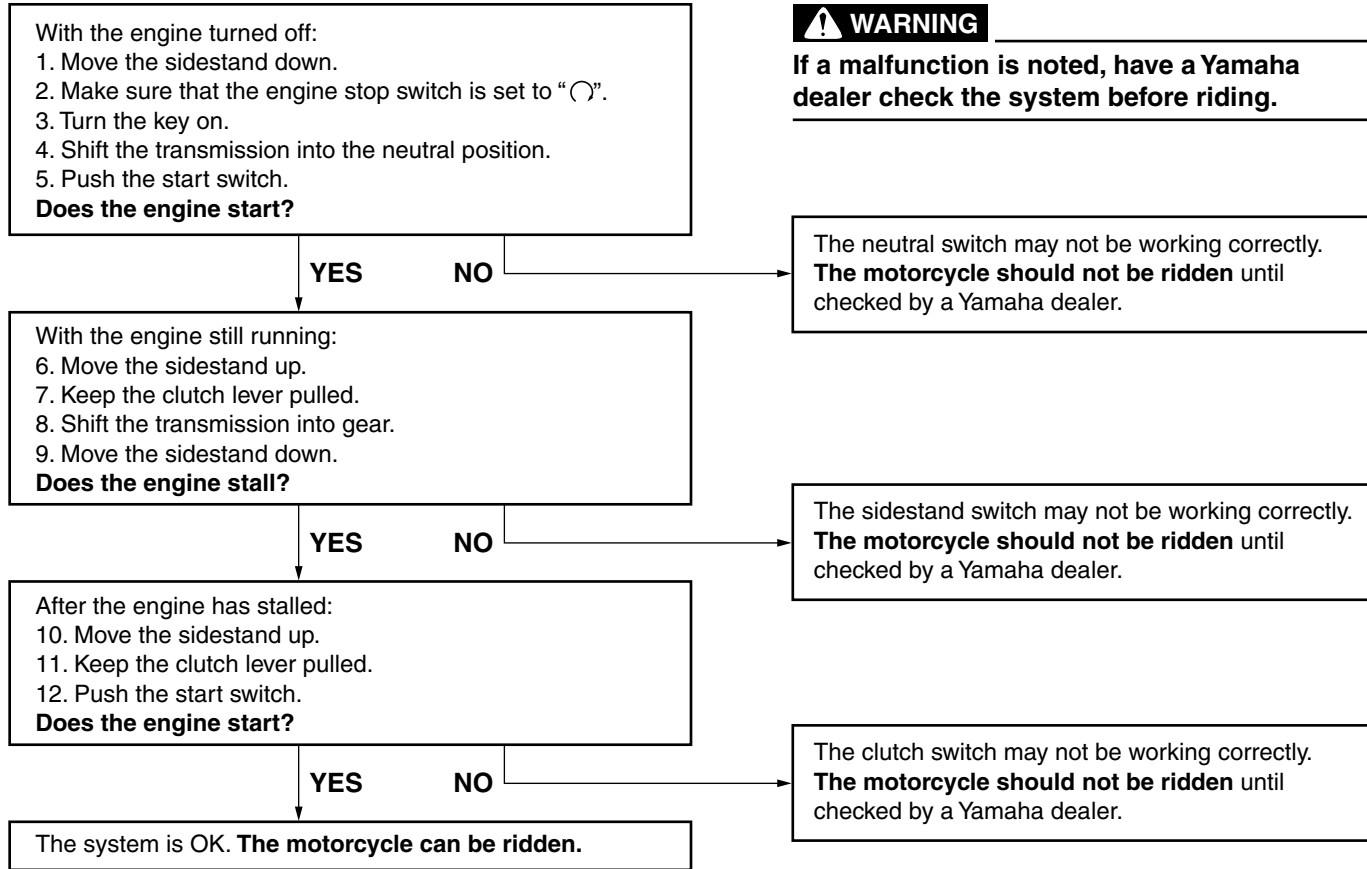

# FOR YOUR SAFETY – PRE-OPERATION CHECKS

EAU15596

Inspect your vehicle each time you use it to make sure the vehicle is in safe operating condition. Always follow the inspection and maintenance procedures and schedules described in the Owner's Manual.

EWA11151

## **WARNING**

**Failure to inspect or maintain the vehicle properly increases the possibility of an accident or equipment damage. Do not operate the vehicle if you find any problem. If a problem cannot be corrected by the procedures provided in this manual, have the vehicle inspected by a Yamaha dealer.**

Before using this vehicle, check the following points:

ITEM	CHECKS	PAGE
<b>Fuel</b>	<ul style="list-style-type: none"><li>• Check fuel level in fuel tank.</li><li>• Refuel if necessary.</li><li>• Check fuel line for leakage.</li></ul>	4-11
<b>Engine oil</b>	<ul style="list-style-type: none"><li>• Check oil level in engine.</li><li>• If necessary, add recommended oil to specified level.</li><li>• Check vehicle for oil leakage.</li></ul>	7-7
<b>Front brake</b>	<ul style="list-style-type: none"><li>• Check operation.</li><li>• If soft or spongy, have Yamaha dealer bleed hydraulic system.</li><li>• Check lever free play.</li><li>• Adjust if necessary.</li><li>• Check brake pads for wear.</li><li>• Replace if necessary.</li><li>• Check fluid level in reservoir.</li><li>• If necessary, add recommended brake fluid to specified level.</li><li>• Check hydraulic system for leakage.</li></ul>	7-15, 7-16, 7-17

# FOR YOUR SAFETY – PRE-OPERATION CHECKS

ITEM	CHECKS	PAGE
<b>Rear brake</b>	<ul style="list-style-type: none"> <li>• Check operation.</li> <li>• If soft or spongy, have Yamaha dealer bleed hydraulic system.</li> <li>• Check brake pads for wear.</li> <li>• Replace if necessary.</li> <li>• Check fluid level in reservoir.</li> <li>• If necessary, add recommended brake fluid to specified level.</li> <li>• Check hydraulic system for leakage.</li> </ul>	7-16, 7-17
<b>Clutch</b>	<ul style="list-style-type: none"> <li>• Check operation.</li> <li>• Lubricate cable if necessary.</li> <li>• Check lever free play.</li> <li>• Adjust if necessary.</li> </ul>	7-14
<b>Throttle grip</b>	<ul style="list-style-type: none"> <li>• Make sure that operation is smooth.</li> <li>• Check cable free play.</li> <li>• If necessary, have Yamaha dealer adjust cable free play and lubricate cable and grip housing.</li> </ul>	7-12, 7-20
<b>Control cables</b>	<ul style="list-style-type: none"> <li>• Make sure that operation is smooth.</li> <li>• Lubricate if necessary.</li> </ul>	7-20
<b>Wheels and tires</b>	<ul style="list-style-type: none"> <li>• Check for damage.</li> <li>• Check tire condition and tread depth.</li> <li>• Check air pressure.</li> <li>• Correct if necessary.</li> </ul>	7-12, 7-14
<b>Brake and shift pedals</b>	<ul style="list-style-type: none"> <li>• Make sure that operation is smooth.</li> <li>• Lubricate pedal pivoting points if necessary.</li> </ul>	7-21
<b>Brake and clutch levers</b>	<ul style="list-style-type: none"> <li>• Make sure that operation is smooth.</li> <li>• Lubricate lever pivoting points if necessary.</li> </ul>	7-21
<b>Sidestand</b>	<ul style="list-style-type: none"> <li>• Make sure that operation is smooth.</li> <li>• Lubricate pivot if necessary.</li> </ul>	7-22
<b>Chassis fasteners</b>	<ul style="list-style-type: none"> <li>• Make sure that all nuts, bolts and screws are properly tightened.</li> <li>• Tighten if necessary.</li> </ul>	—
<b>Instruments, lights, signals and switches</b>	<ul style="list-style-type: none"> <li>• Check operation.</li> <li>• Correct if necessary.</li> </ul>	—

# FOR YOUR SAFETY – PRE-OPERATION CHECKS

ITEM	CHECKS	PAGE
Sidestand switch	<ul style="list-style-type: none"><li>• Check operation of ignition circuit cut-off system.</li><li>• If system is not working correctly, have Yamaha dealer check vehicle.</li></ul>	4-16

# OPERATION AND IMPORTANT RIDING POINTS

EAU15951

EAU47150

EAU47230

Read the Owner's Manual carefully to become familiar with all controls. If there is a control or function you do not understand, ask your Yamaha dealer.

EWA10271



**Failure to familiarize yourself with the controls can lead to loss of control, which could cause an accident or injury.**

## TIP

This model is equipped with:

- a lean angle sensor to stop the engine in case of a turnover. In this case, the multi-function meter unit indicates error code 30, but this is not a malfunction. Turn the key to "OFF" and then to "ON" to clear the error code. Failing to do so will prevent the engine from starting even though the engine will crank when pushing the start switch.
- an engine auto-stop system. The engine stops automatically if left idling for 20 minutes. In this case, the multi-function meter unit indicates error code 70, but this is not a malfunction. Push the start switch to clear the error code and to restart the engine.

## Starting the engine

In order for the ignition circuit cut-off system to enable starting, one of the following conditions must be met:

- The transmission is in the neutral position.
- The transmission is in gear with the clutch lever pulled and the sidestand up.

See page 4-16 for more information.

1. Turn the key to "ON" and make sure that the engine stop switch is set to "○".

The following warning lights and indicator light should come on for a few seconds, then go off.

- Oil level warning light
- Fuel level warning light
- Engine trouble warning light
- Immobilizer system indicator light

ECA11831

## NOTICE

**If a warning or indicator light does not go off, see page 4-3 for the corresponding warning and indicator light circuit check.**

2. Shift the transmission into the neu-

# OPERATION AND IMPORTANT RIDING POINTS

tral position. (See page 6-2.) The neutral indicator light should come on. If not, ask a Yamaha dealer to check the electrical circuit.

3. Start the engine by pushing the start switch. **NOTICE: For maximum engine life, never accelerate hard when the engine is cold!**<sup>[ECA11041]</sup>

If the engine fails to start, release the start switch, wait a few seconds, and then try again. Each starting attempt should be as short as possible to preserve the battery. Do not crank the engine more than 10 seconds on any one attempt.

## Shifting

EAU16671

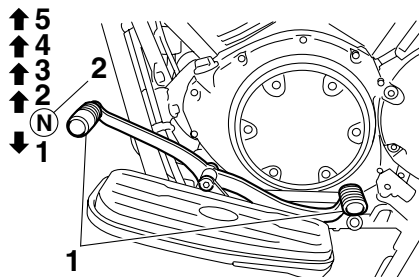

1. Shift pedal
2. Neutral position

Shifting gears lets you control the amount of engine power available for starting off, accelerating, climbing hills, etc.

The gear positions are shown in the illustration.

### TIP

To shift the transmission into the neutral position, press the shift pedal repeatedly until it reaches the end of its travel, and then slightly raise it.

ECA10260

### NOTICE

- Even with the transmission in

the neutral position, do not coast for long periods of time with the engine off, and do not tow the motorcycle for long distances. The transmission is properly lubricated only when the engine is running. Inadequate lubrication may damage the transmission.

- Always use the clutch while changing gears to avoid damaging the engine, transmission, and drive train, which are not designed to withstand the shock of forced shifting.



# OPERATION AND IMPORTANT RIDING POINTS

## Tips for reducing fuel consumption

EAU16810

Fuel consumption depends largely on your riding style. Consider the following tips to reduce fuel consumption:

- Shift up swiftly, and avoid high engine speeds during acceleration.
- Do not rev the engine while shifting down, and avoid high engine speeds with no load on the engine.
- Turn the engine off instead of letting it idle for an extended length of time (e.g., in traffic jams, at traffic lights or at railroad crossings).

## Engine break-in

EAU16841

There is never a more important period in the life of your engine than the period between 0 and 1600 km (1000 mi). For this reason, you should read the following material carefully.

Since the engine is brand new, do not put an excessive load on it for the first 1600 km (1000 mi). The various parts in the engine wear and polish themselves to the correct operating clearances. During this period, prolonged full-throttle operation or any condition that might result in engine overheating must be avoided.

EAU17023

## 0–1000 km (0–600 mi)

Avoid prolonged operation above 1/3 throttle. **NOTICE: After 1000 km (600 mi) of operation, the engine oil must be changed, and the oil filter cartridge or element replaced.**<sup>[ECA11282]</sup>

## 1000–1600 km (600–1000 mi)

Avoid prolonged operation above 1/2 throttle.

## 1600 km (1000 mi) and beyond

The vehicle can now be operated normally.

ECA10270

### **NOTICE**

**If any engine trouble should occur during the engine break-in period, immediately have a Yamaha dealer check the vehicle.**

# OPERATION AND IMPORTANT RIDING POINTS

---

---

EAU17213

## Parking

When parking, stop the engine, and then remove the key from the main switch.

EWA10311

### **WARNING**

- Since the engine and exhaust system can become very hot, park in a place where pedestrians or children are not likely to touch them and be burned.
  - Do not park on a slope or on soft ground, otherwise the vehicle may overturn, increasing the risk of a fuel leak and fire.
  - Do not park near grass or other flammable materials which might catch fire.
-

# PERIODIC MAINTENANCE AND ADJUSTMENT

EAU17241

Periodic inspection, adjustment, and lubrication will keep your vehicle in the safest and most efficient condition possible. Safety is an obligation of the vehicle owner/operator. The most important points of vehicle inspection, adjustment, and lubrication are explained on the following pages.

The intervals given in the periodic maintenance and lubrication chart should be simply considered as a general guide under normal riding conditions. However, depending on the weather, terrain, geographical location, and individual use, the maintenance intervals may need to be shortened.

EWA10321

## **WARNING**

**Failure to properly maintain the vehicle or performing maintenance activities incorrectly may increase your risk of injury or death during service or while using the vehicle. If you are not familiar with vehicle service, have a Yamaha dealer perform service.**

EWA15121

## **WARNING**

**Turn off the engine when performing maintenance unless otherwise specified.**

- **A running engine has moving parts that can catch on body parts or clothing and electrical parts that can cause shocks or fires.**
- **Running the engine while servicing can lead to eye injury, burns, fire, or carbon monoxide poisoning – possibly leading to death. See page 2-1 for more information about carbon monoxide.**

EAU17361

## Owner's tool kit

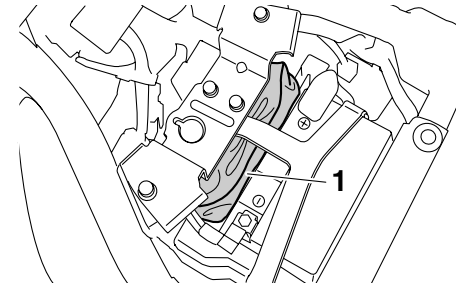

1. Owner's tool kit

The owner's tool kit is located under the rider seat. (See page 4-13.)

The service information included in this manual and the tools provided in the owner's tool kit are intended to assist you in the performance of preventive maintenance and minor repairs. However, additional tools such as a torque wrench may be necessary to perform certain maintenance work correctly.

## TIP

If you do not have the tools or experience required for a particular job, have a Yamaha dealer perform it for you.

# PERIODIC MAINTENANCE AND ADJUSTMENT

EAU46860

## TIP

- The annual checks must be performed every year, except if a kilometer-based maintenance, or for the UK, a mileage-based maintenance, is performed instead.
- From 50000 km (30000 mi), repeat the maintenance intervals starting from 10000 km (6000 mi).
- Items marked with an asterisk should be performed by a Yamaha dealer as they require special tools, data and technical skills.

EAU46910

## Periodic maintenance chart for the emission control system

NO.	ITEM	CHECK OR MAINTENANCE JOB	ODOMETER READING					ANNUAL CHECK
			1000 km (600 mi)	10000 km (6000 mi)	20000 km (12000 mi)	30000 km (18000 mi)	40000 km (24000 mi)	
1	* Fuel line	<ul style="list-style-type: none"> <li>● Check fuel hoses for cracks or damage.</li> </ul>		√	√	√	√	√
2	* Spark plugs	<ul style="list-style-type: none"> <li>● Check condition.</li> <li>● Clean and regap.</li> </ul>		√		√		
		<ul style="list-style-type: none"> <li>● Replace.</li> </ul>			√		√	
3	* Valves	<ul style="list-style-type: none"> <li>● Check valve clearance.</li> <li>● Adjust.</li> </ul>			√		√	
4	* Fuel injection system	<ul style="list-style-type: none"> <li>● Adjust synchronization.</li> </ul>		√	√	√	√	√
5	* Muffler and exhaust pipe	<ul style="list-style-type: none"> <li>● Check the screw clamp(s) for looseness.</li> </ul>	√	√	√	√	√	

# PERIODIC MAINTENANCE AND ADJUSTMENT

EAU1770B

## General maintenance and lubrication chart

NO.	ITEM	CHECK OR MAINTENANCE JOB	ODOMETER READING					ANNUAL CHECK
			1000 km (600 mi)	10000 km (6000 mi)	20000 km (12000 mi)	30000 km (18000 mi)	40000 km (24000 mi)	
1	<b>Air filter element</b>	<ul style="list-style-type: none"> <li>Replace.</li> </ul>					√	
2	<b>Clutch</b>	<ul style="list-style-type: none"> <li>Check operation.</li> <li>Adjust.</li> </ul>	√	√	√	√	√	
3	* <b>Front brake</b>	<ul style="list-style-type: none"> <li>Check operation, fluid level and vehicle for fluid leakage.</li> <li>Adjust brake lever free play.</li> </ul>	√	√	√	√	√	√
		<ul style="list-style-type: none"> <li>Replace brake pads.</li> </ul>	Whenever worn to the limit					
4	* <b>Rear brake</b>	<ul style="list-style-type: none"> <li>Check operation, fluid level and vehicle for fluid leakage.</li> </ul>	√	√	√	√	√	√
		<ul style="list-style-type: none"> <li>Replace brake pads.</li> </ul>	Whenever worn to the limit					
5	* <b>Brake hoses</b>	<ul style="list-style-type: none"> <li>Check for cracks or damage.</li> </ul>		√	√	√	√	√
		<ul style="list-style-type: none"> <li>Replace.</li> </ul>	Every 4 years					
6	* <b>Wheels</b>	<ul style="list-style-type: none"> <li>Check runout and for damage.</li> </ul>		√	√	√	√	
7	* <b>Tires</b>	<ul style="list-style-type: none"> <li>Check tread depth and for damage.</li> </ul>						
		<ul style="list-style-type: none"> <li>Replace if necessary.</li> </ul>		√	√	√	√	√
		<ul style="list-style-type: none"> <li>Check air pressure.</li> </ul>						
		<ul style="list-style-type: none"> <li>Correct if necessary.</li> </ul>						
8	* <b>Wheel bearings</b>	<ul style="list-style-type: none"> <li>Check bearing for looseness or damage.</li> </ul>		√	√	√	√	
9	* <b>Swingarm</b>	<ul style="list-style-type: none"> <li>Check operation and for excessive play.</li> </ul>		√	√	√	√	
10	* <b>Drive belt</b>	<ul style="list-style-type: none"> <li>Check belt tension.</li> <li>Make sure that the rear wheel is properly aligned.</li> </ul>	Every 4000 km (2500 mi)					

# PERIODIC MAINTENANCE AND ADJUSTMENT

NO.	ITEM	CHECK OR MAINTENANCE JOB	ODOMETER READING					ANNUAL CHECK
			1000 km (600 mi)	10000 km (6000 mi)	20000 km (12000 mi)	30000 km (18000 mi)	40000 km (24000 mi)	
11	* <b>Steering bearings</b>	<ul style="list-style-type: none"> <li>Check bearing play and steering for roughness.</li> </ul>	√	√	√	√	√	
		<ul style="list-style-type: none"> <li>Lubricate with lithium-soap-based grease.</li> </ul>	Every 20000 km (12000 mi)					
12	* <b>Chassis fasteners</b>	<ul style="list-style-type: none"> <li>Make sure that all nuts, bolts and screws are properly tightened.</li> </ul>		√	√	√	√	√
13	<b>Brake lever pivot shaft</b>	<ul style="list-style-type: none"> <li>Lubricate with silicone grease.</li> </ul>		√	√	√	√	√
14	<b>Brake pedal pivot shaft</b>	<ul style="list-style-type: none"> <li>Lubricate with lithium-soap-based grease.</li> </ul>		√	√	√	√	√
15	<b>Clutch lever pivot shaft</b>	<ul style="list-style-type: none"> <li>Lubricate with lithium-soap-based grease.</li> </ul>		√	√	√	√	√
16	<b>Shift pedal pivot shaft</b>	<ul style="list-style-type: none"> <li>Lubricate with lithium-soap-based grease.</li> </ul>		√	√	√	√	√
17	<b>Sidestand</b>	<ul style="list-style-type: none"> <li>Check operation.</li> <li>Lubricate.</li> </ul>		√	√	√	√	√
18	* <b>Sidestand switch</b>	<ul style="list-style-type: none"> <li>Check operation.</li> </ul>	√	√	√	√	√	√
19	* <b>Front fork</b>	<ul style="list-style-type: none"> <li>Check operation and for oil leakage.</li> </ul>		√	√	√	√	
20	* <b>Shock absorber assembly</b>	<ul style="list-style-type: none"> <li>Check operation and shock absorber for oil leakage.</li> </ul>		√	√	√	√	
21	* <b>Rear suspension relay arm and connecting arm pivoting points</b>	<ul style="list-style-type: none"> <li>Check operation.</li> </ul>		√	√	√	√	
		<ul style="list-style-type: none"> <li>Lubricate with lithium-soap-based grease.</li> </ul>			√		√	
22	<b>Engine oil</b>	<ul style="list-style-type: none"> <li>Change.</li> <li>Check oil level and vehicle for oil leakage.</li> </ul>	√	√	√	√	√	√

# PERIODIC MAINTENANCE AND ADJUSTMENT

NO.	ITEM	CHECK OR MAINTENANCE JOB	ODOMETER READING					ANNUAL CHECK
			1000 km (600 mi)	10000 km (6000 mi)	20000 km (12000 mi)	30000 km (18000 mi)	40000 km (24000 mi)	
23	<b>Engine oil filter cartridge</b>	<ul style="list-style-type: none"> <li>Replace.</li> </ul>	√		√		√	
24	* <b>Front and rear brake switches</b>	<ul style="list-style-type: none"> <li>Check operation.</li> </ul>	√	√	√	√	√	√
25	<b>Moving parts and cables</b>	<ul style="list-style-type: none"> <li>Lubricate.</li> </ul>		√	√	√	√	√
26	* <b>Throttle grip housing and cable</b>	<ul style="list-style-type: none"> <li>Check operation and free play.</li> <li>Adjust the throttle cable free play if necessary.</li> <li>Lubricate the throttle grip housing and cable.</li> </ul>		√	√	√	√	√
27	* <b>Lights, signals and switches</b>	<ul style="list-style-type: none"> <li>Check operation.</li> <li>Adjust headlight beam.</li> </ul>	√	√	√	√	√	√

EAU18680

## TIP

- **Air filter**
  - This model's air filter is equipped with a disposable oil-coated paper element, which must not be cleaned with compressed air to avoid damaging it.
  - The air filter element needs to be replaced more frequently when riding in unusually wet or dusty areas.
- **Hydraulic brake service**
  - Regularly check and, if necessary, correct the brake fluid level.
  - Every two years replace the internal components of the brake master cylinders and calipers, and change the brake fluid.
  - Replace the brake hoses every four years and if cracked or damaged.

# PERIODIC MAINTENANCE AND ADJUSTMENT

## Removing and installing the panel

The panel shown needs to be removed to perform some of the maintenance jobs described in this chapter. Refer to this section each time the panel needs to be removed and installed.

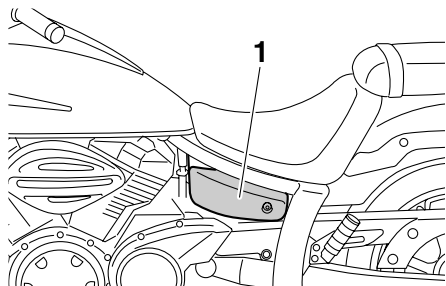

1. Panel A

## Panel A

### To remove the panel

Remove the bolt, and then pull the panel off as shown.

EAU18751

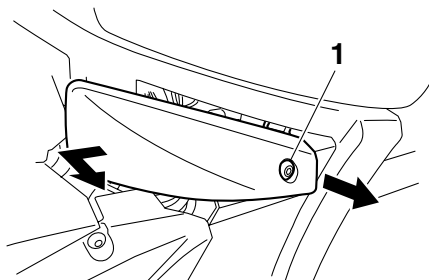

1. Bolt

### To install the panel

Place the panel in the original position, and then install the bolt.

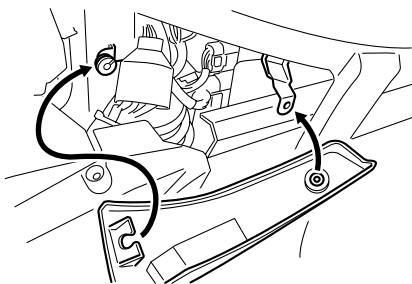

EAU19151

## Checking the spark plugs

The spark plugs are important engine components, which should be checked periodically, preferably by a Yamaha dealer. Since heat and deposits will cause any spark plug to slowly erode, they should be removed and checked in accordance with the periodic maintenance and lubrication chart. In addition, the condition of the spark plugs can reveal the condition of the engine.

The porcelain insulator around the center electrode of each spark plug should be a medium-to-light tan (the ideal color when the vehicle is ridden normally), and all spark plugs installed in the engine should have the same color. If any spark plug shows a distinctly different color, the engine could be operating improperly. Do not attempt to diagnose such problems yourself. Instead, have a Yamaha dealer check the vehicle. If a spark plug shows signs of electrode erosion and excessive carbon or other deposits, it should be replaced.

EAU19642

**Specified spark plug:**  
NGK/CPR7EA-9



# PERIODIC MAINTENANCE AND ADJUSTMENT

EAU47110

Before installing a spark plug, the spark plug gap should be measured with a wire thickness gauge and, if necessary, adjusted to specification.

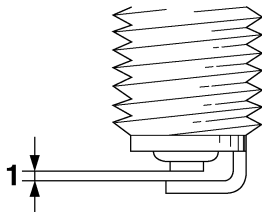

1. Spark plug gap

## Spark plug gap:

0.8–0.9 mm (0.031–0.035 in)

Clean the surface of the spark plug gasket and its mating surface, and then wipe off any grime from the spark plug threads.

## Tightening torque:

Spark plug:  
12.5 Nm (1.3 m·kgf, 9 ft·lbf)

## TIP

If a torque wrench is not available when

installing a spark plug, a good estimate of the correct torque is 1/4–1/2 turn past finger tight. However, the spark plug should be tightened to the specified torque as soon as possible.

## Engine oil and oil filter cartridge

The engine oil level should be checked before each ride. In addition, the oil must be changed and the oil filter cartridge replaced at the intervals specified in the periodic maintenance and lubrication chart.

### To check the engine oil level

1. Place the vehicle on a level surface and hold it in an upright position. A slight tilt to the side can result in a false reading.
2. Start the engine, warm it up for several minutes, and then turn it off.
3. Wait a few minutes until the oil settles.
4. Remove the engine oil filler cap, wipe the dipstick clean, insert it back into the oil filler hole (without screwing it in), and then remove it again to check the oil level.

# PERIODIC MAINTENANCE AND ADJUSTMENT

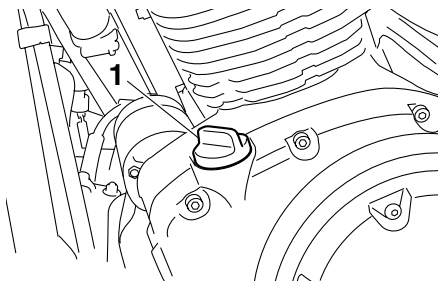

1. Engine oil filler cap

## TIP

The engine oil should be between the minimum and maximum level marks.

5. If the engine oil is at or below the minimum level mark, add sufficient oil of the recommended type to raise it to the correct level.

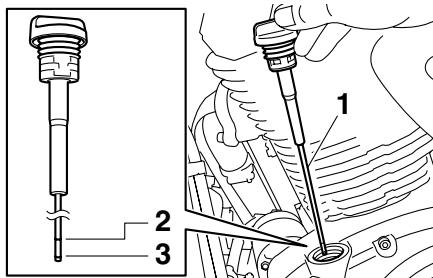

1. Dipstick
2. Maximum level mark
3. Minimum level mark

6. Insert the dipstick into the oil filler hole, and then tighten the oil filler cap.

## To change the engine oil (with or without oil filter cartridge replacement)

1. Start the engine, warm it up for several minutes, and then turn it off.
2. Place an oil pan under the engine to collect the used oil.
3. Remove the engine oil filler cap and drain bolt to drain the oil from the crankcase.

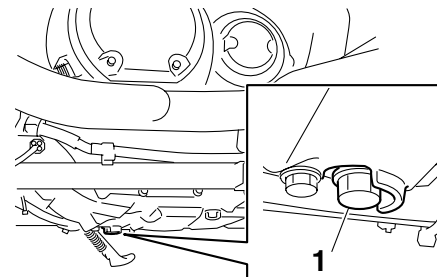

1. Engine oil drain bolt

## TIP

Skip steps 4–6 if the oil filter cartridge is not being replaced.

4. Remove the oil filter cartridge with an oil filter wrench.

# PERIODIC MAINTENANCE AND ADJUSTMENT

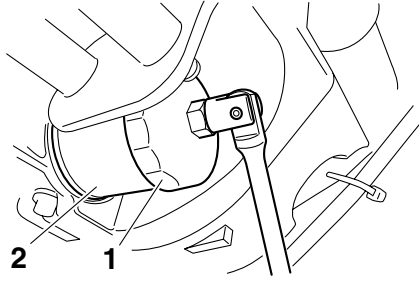

1. Oil filter wrench
2. Oil filter cartridge

**TIP** \_\_\_\_\_  
An oil filter wrench is available at a Yamaha dealer.

5. Apply a thin coat of clean engine oil to the O-ring of the new oil filter cartridge.

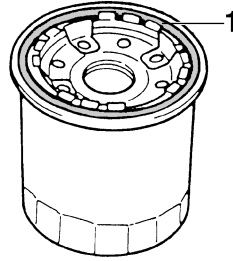

1. O-ring

**TIP** \_\_\_\_\_  
Make sure that the O-ring is properly seated.

6. Install the new oil filter cartridge with an oil filter wrench, and then tighten it to the specified torque with a torque wrench.

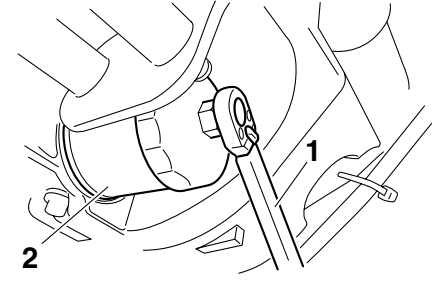

1. Torque wrench
2. Oil filter cartridge

**Tightening torque:**  
Oil filter cartridge:  
17 Nm (1.7 m·kgf, 12 ft·lbf)

7. Install the engine oil drain bolt, and then tighten it to the specified torque.

**TIP** \_\_\_\_\_  
Check the washer for damage and replace it if necessary.

**Tightening torque:**  
Engine oil drain bolt:  
43 Nm (4.3 m·kgf, 30 ft·lbf)

8. Refill with the specified amount of the recommended engine oil, and

# PERIODIC MAINTENANCE AND ADJUSTMENT

then install and tighten the oil filler cap.

## Recommended engine oil:

See page 9-1.

## Oil quantity:

Without oil filter cartridge replacement:

3.70 L (3.91 US qt, 3.26 Imp.qt)

With oil filter cartridge replacement:

4.00 L (4.23 US qt, 3.52 Imp.qt)

## TIP

Be sure to wipe off spilled oil on any parts after the engine and exhaust system have cooled down.

ECA11620

## NOTICE

- In order to prevent clutch slippage (since the engine oil also lubricates the clutch), do not mix any chemical additives. Do not use oils with a diesel specification of “CD” or oils of a higher quality than specified. In addition, do not use oils labeled “ENERGY CONSERVING II” or higher.
- Make sure that no foreign mate-

rial enters the crankcase.

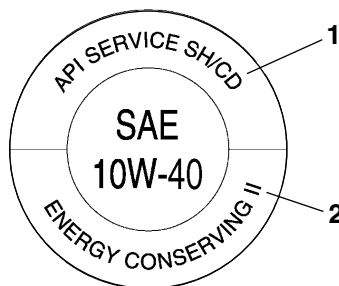

1. “CD” specification
2. “ENERGY CONSERVING II”

9. Start the engine, and then let it idle for several minutes while checking it for oil leakage. If oil is leaking, immediately turn the engine off and check for the cause.

## TIP

After the engine is started, the engine oil level warning light should go off if the oil level is sufficient.

ECA10400

## NOTICE

If the oil level warning light flickers or remains on, immediately turn the engine off and have a Yamaha dealer

check the vehicle.

10. Turn the engine off, and then check the oil level and correct it if necessary.

# PERIODIC MAINTENANCE AND ADJUSTMENT

EAU47080

## Replacing the air filter element

The air filter element should be replaced at the intervals specified in the periodic maintenance and lubrication chart. Replace the air filter element more frequently if you are riding in unusually wet or dusty areas.

### To replace the air filter element

1. Remove the air filter case cover by removing the bolts.

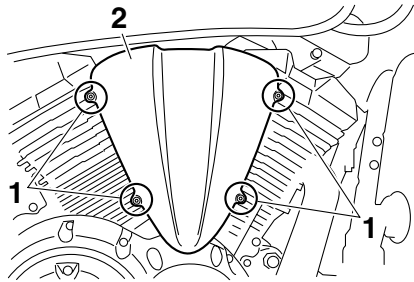

1. Bolt
2. Air filter case cover

2. Pull the air filter element out.

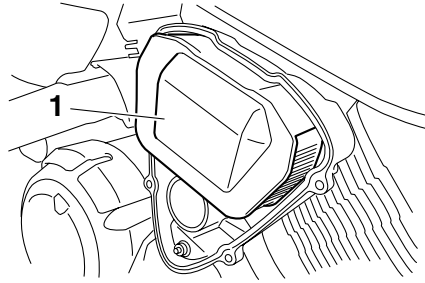

1. Air filter element

3. Insert a new air filter element into the air filter case. **NOTICE: Make sure that the air filter element is properly seated in the air filter case. The engine should never be operated without the air filter element installed, otherwise the piston(s) and/or cylinder(s) may become excessively worn.** [ECA10481]
4. Install the air filter case cover by installing the bolts.

EAU44734

## Checking the engine idling speed

Check the engine idling speed and, if necessary, have it corrected by a Yamaha dealer.

**Engine idling speed:**  
950–1050 r/min

# PERIODIC MAINTENANCE AND ADJUSTMENT

EAU21382

## Checking the throttle cable free play

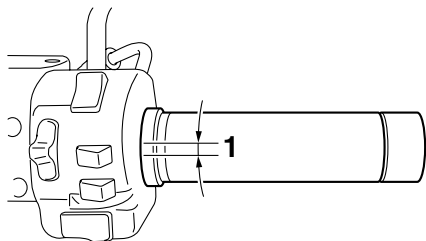

### 1. Throttle cable free play

The throttle cable free play should measure 4.0–6.0 mm (0.16–0.24 in) at the throttle grip. Periodically check the throttle cable free play and, if necessary, have a Yamaha dealer adjust it.

7

EAU21401

## Valve clearance

The valve clearance changes with use, resulting in improper air-fuel mixture and/or engine noise. To prevent this from occurring, the valve clearance must be adjusted by a Yamaha dealer at the intervals specified in the periodic maintenance and lubrication chart.

EAU32654

## Tires

To maximize the performance, durability, and safe operation of your motorcycle, note the following points regarding the specified tires.

### Tire air pressure

The tire air pressure should be checked and, if necessary, adjusted before each ride.

EWA10501

### **⚠ WARNING**

**Operation of this vehicle with improper tire pressure may cause severe injury or death from loss of control.**

- The tire air pressure must be checked and adjusted on cold tires (i.e., when the temperature of the tires equals the ambient temperature).
- The tire air pressure must be adjusted in accordance with the riding speed and with the total weight of rider, passenger, cargo, and accessories approved for this model.

# PERIODIC MAINTENANCE AND ADJUSTMENT

## Tire air pressure (measured on cold tires):

### 0–90 kg (0–198 lb):

Front:

225 kPa (2.25 kgf/cm<sup>2</sup>, 33 psi)

Rear:

250 kPa (2.50 kgf/cm<sup>2</sup>, 36 psi)

### 90–210 kg (198–463 lb):

Front:

225 kPa (2.25 kgf/cm<sup>2</sup>, 33 psi)

Rear:

250 kPa (2.50 kgf/cm<sup>2</sup>, 36 psi)

### Maximum load\*:

210 kg (463 lb)

\* Total weight of rider, passenger, cargo and accessories

EWA10511

## WARNING

Never overload your vehicle. Operation of an overloaded vehicle could cause an accident.

## Tire inspection

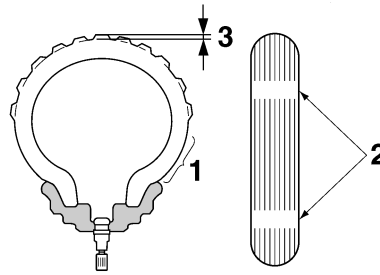

1. Tire sidewall
2. Tire wear indicator
3. Tire tread depth

Always check the tires before operating the motorcycle. If a tire tread shows crosswise lines (minimum tread depth), if the tire has a nail or glass fragments in it, or if the sidewall is cracked, contact a Yamaha dealer immediately and have the tire replaced.

### Minimum tire tread depth (front and rear):

1.0 mm (0.04 in)

## TIP

These limits may be different by regulation from country to country. If so, con-

form to the limits specified by the regulations of your own country.

EWA10470

## WARNING

- Have a Yamaha dealer replace excessively worn tires. Besides being illegal, operating the vehicle with excessively worn tires decreases riding stability and can lead to loss of control.
- The replacement of all wheel and brake related parts, including the tires, should be left to a Yamaha dealer, who has the necessary professional knowledge and experience.

## Tire information

This motorcycle is equipped with cast wheels and tubeless tires.

EWA10461

## WARNING

The front and rear tires should be of the same make and design, otherwise the handling characteristics of the vehicle may be different, which could lead to an accident.

# PERIODIC MAINTENANCE AND ADJUSTMENT

After extensive tests, only the tires listed below have been approved for this model by Yamaha Motor Co., Ltd.

## Front tire:

Size:

130/70-18M/C 63H

Manufacturer/model:

BRIDGESTONE/EXEDRA

G721 J

DUNLOP/D404F

## Rear tire:

Size:

170/70B16M/C 75H

Manufacturer/model:

BRIDGESTONE/EXEDRA

G722 J

DUNLOP/K555

EAU21960

EAU22043

## Cast wheels

To maximize the performance, durability, and safe operation of your vehicle, note the following points regarding the specified wheels.

- The wheel rims should be checked for cracks, bends or warpage before each ride. If any damage is found, have a Yamaha dealer replace the wheel. Do not attempt even the smallest repair to the wheel. A deformed or cracked wheel must be replaced.
- The wheel should be balanced whenever either the tire or wheel has been changed or replaced. An unbalanced wheel can result in poor performance, adverse handling characteristics, and a shortened tire life.
- Ride at moderate speeds after changing a tire since the tire surface must first be “broken in” for it to develop its optimal characteristics.

## Adjusting the clutch lever free play

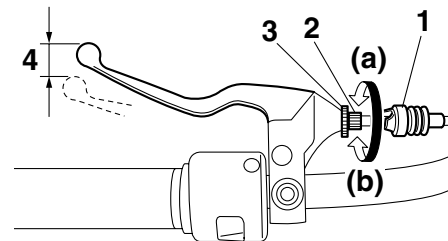

1. Rubber cover
2. Clutch lever free play adjusting bolt
3. Locknut
4. Clutch lever free play

The clutch lever free play should measure 5.0–10.0 mm (0.20–0.39 in) as shown. Periodically check the clutch lever free play and, if necessary, adjust it as follows.

1. Slide the rubber cover back at the clutch lever.
2. Loosen the locknut.
3. To increase the clutch lever free play, turn the adjusting bolt in direction (a). To decrease the clutch



# PERIODIC MAINTENANCE AND ADJUSTMENT

lever free play, turn the adjusting bolt in direction (b).

## TIP

If the specified clutch lever free play could be obtained as described above, skip steps 4–7.

4. Fully turn the adjusting bolt at the clutch lever in direction (a) to loosen the clutch cable.
5. Loosen the locknut at the crankcase.

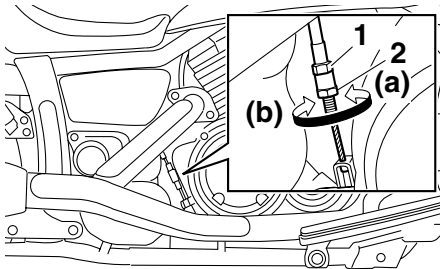

1. Clutch lever free play adjusting nut (crankcase)
2. Locknut (crankcase)

6. To increase the clutch lever free play, turn the adjusting nut in direction (a). To decrease the clutch lever free play, turn the adjusting nut

in direction (b).

7. Tighten the locknut at the crankcase.
8. Tighten the locknut at the clutch lever and then slide the rubber cover to its original position.

EAU22093

## Adjusting the brake lever free play

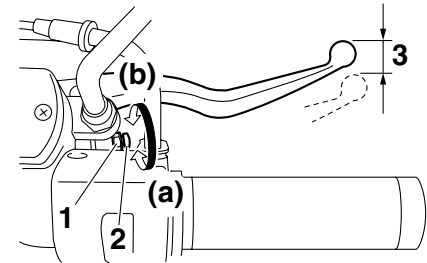

1. Locknut
2. Brake lever free play adjusting screw
3. Brake lever free play

The brake lever free play should measure 10.0–15.0 mm (0.39–0.59 in) as shown. Periodically check the brake lever free play and, if necessary, adjust it as follows.

1. Loosen the locknut at the brake lever.
2. To increase the brake lever free play, turn the brake lever free play adjusting screw in direction (a). To decrease the brake lever free play, turn the adjusting screw in

# PERIODIC MAINTENANCE AND ADJUSTMENT

direction (b).

3. Tighten the locknut.

EWA10630

## ⚠ WARNING

- After adjusting the brake lever free play, check the free play and make sure that the brake is working properly.
- A soft or spongy feeling in the brake lever can indicate the presence of air in the hydraulic system. If there is air in the hydraulic system, have a Yamaha dealer bleed the system before operating the motorcycle. Air in the hydraulic system will diminish the braking performance, which may result in loss of control and an accident.

## Adjusting the rear brake light switch

EAU22272

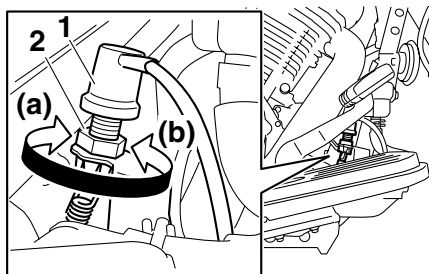

1. Rear brake light switch
2. Rear brake light switch adjusting nut

The rear brake light, which is activated by the brake pedal, should come on just before braking takes effect. If necessary, adjust the rear brake light switch as follows.

Turn the rear brake light switch adjusting nut while holding the rear brake light switch in place. To make the brake light come on earlier, turn the adjusting nut in direction (a). To make the brake light come on later, turn the adjusting nut in direction (b).

## Checking the front and rear brake pads

EAU22390

The front and rear brake pads must be checked for wear at the intervals specified in the periodic maintenance and lubrication chart.

### Front brake pads

EAU22430

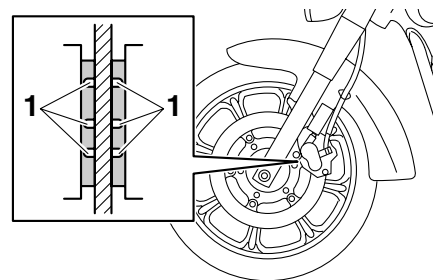

1. Wear indicator groove

Each front brake pad is provided with wear indicator grooves, which allow you to check the brake pad wear without having to disassemble the brake. To check the brake pad wear, check the wear indicator grooves. If a brake pad has worn to the point that the wear

# PERIODIC MAINTENANCE AND ADJUSTMENT

indicator grooves have almost disappeared, have a Yamaha dealer replace the brake pads as a set.

## Rear brake pads

EAU22460

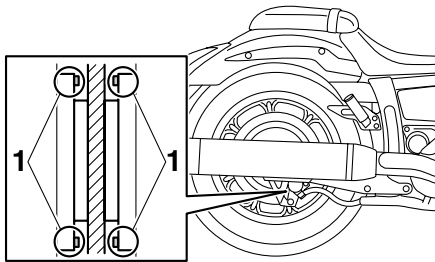

1. Wear indicator

Each rear brake pad is provided with a wear indicator, which allows you to check the brake pad wear without having to disassemble the brake. To check the brake pad wear, check the position of the wear indicator while applying the brake. If a brake pad has worn to the point that the wear indicator almost touches the brake disc, have a Yamaha dealer replace the brake pads as a set.

## Checking the brake fluid level

EAU22580

### Front brake

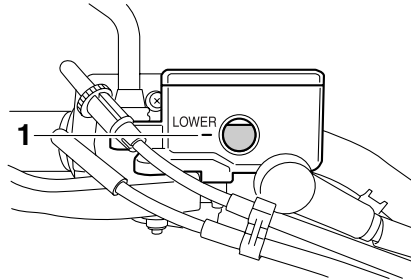

1. Minimum level mark

### Rear brake

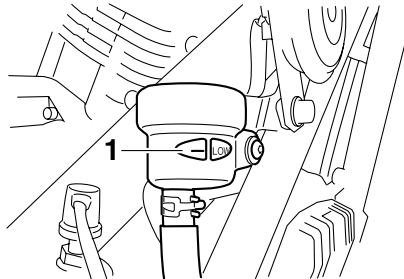

1. Minimum level mark

Insufficient brake fluid may allow air to

enter the brake system, possibly causing it to become ineffective.

Before riding, check that the brake fluid is above the minimum level mark and replenish if necessary. A low brake fluid level may indicate worn brake pads and/or brake system leakage. If the brake fluid level is low, be sure to check the brake pads for wear and the brake system for leakage.

Observe these precautions:

- When checking the fluid level, make sure that the top of the brake fluid reservoir is level.
- Use only the recommended quality brake fluid, otherwise the rubber seals may deteriorate, causing leakage and poor braking performance.

**Recommended brake fluid:**  
DOT 4

- Refill with the same type of brake fluid. Mixing fluids may result in a harmful chemical reaction and lead to poor braking performance.
- Be careful that water does not enter the brake fluid reservoir when

# PERIODIC MAINTENANCE AND ADJUSTMENT

---

refilling. Water will significantly lower the boiling point of the fluid and may result in vapor lock.

- Brake fluid may deteriorate painted surfaces or plastic parts. Always clean up spilled fluid immediately.
- As the brake pads wear, it is normal for the brake fluid level to gradually go down. However, if the brake fluid level goes down suddenly, have a Yamaha dealer check the cause.

EAU22731

## Changing the brake fluid

Have a Yamaha dealer change the brake fluid at the intervals specified in the TIP after the periodic maintenance and lubrication chart. In addition, have the oil seals of the master cylinders and calipers as well as the brake hoses replaced at the intervals listed below or whenever they are damaged or leaking.

- Oil seals: Replace every two years.
- Brake hoses: Replace every four years.

EAU23040

## Drive belt slack

The drive belt slack should be checked and adjusted at the intervals specified in the periodic maintenance and lubrication chart.

EAU23062

### To check the drive belt slack

1. Place the vehicle on the sidestand.
2. Note the current position of the drive belt using the marks near the drive belt check hole.

### TIP

The marks near the drive belt check hole are 5 mm (0.2 in) apart.

---

# PERIODIC MAINTENANCE AND ADJUSTMENT

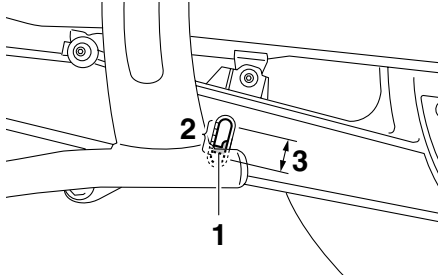

1. Drive belt
2. Marks
3. Drive belt slack

3. Note the position of the drive belt with a force of 45 N (4.5 kgf, 10 lbf) applied to the belt with a belt tension gauge as shown.

## TIP

A belt tension gauge is available at a Yamaha dealer.

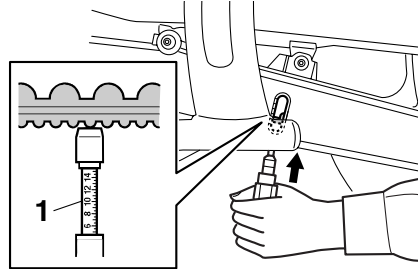

1. Belt tension gauge
4. Calculate the drive belt slack by subtracting the measurement noted in step 2 from the measurement noted in step 3.

**Drive belt slack:**  
3.0–5.0 mm (0.12–0.20 in)

5. If the drive belt slack is incorrect, adjust it as follows.

## To adjust the drive belt slack

1. Loosen the axle nut.

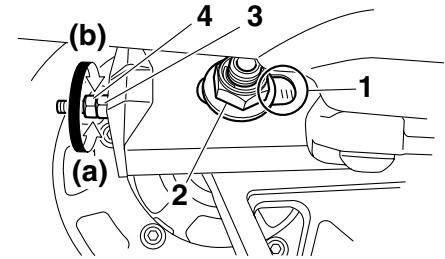

1. Alignment marks
  2. Axle nut
  3. Adjusting nut
  4. Locknut
2. Loosen the locknut on each side of the swingarm.
  3. To tighten the drive belt, turn the adjusting nut on each side of the swingarm in direction (a). To loosen the drive belt, turn the adjusting nut on each side of the swingarm in direction (b), and then push the rear wheel forward. **NOTICE: Improper drive belt slack will overload the engine. Keep the drive belt slack within the specified range.**<sup>[ECA10881]</sup>

EAU47091

# PERIODIC MAINTENANCE AND ADJUSTMENT

EAU23101

EAU23111

**TIP** \_\_\_\_\_  
Using the alignment marks on each side of the swingarm, make sure that both belt pullers are in the same position for proper wheel alignment.

4. Tighten the locknuts and the axle nut to their specified torques.

## **Tightening torques:**

Locknut:

15.5 Nm (1.6 m·kgf, 11 ft·lbf)

Axle nut:

150 Nm (15.0 m·kgf, 108 ft·lbf)

## **Checking and lubricating the cables**

The operation of all control cables and the condition of the cables should be checked before each ride, and the cables and cable ends should be lubricated if necessary. If a cable is damaged or does not move smoothly, have a Yamaha dealer check or replace it.

**WARNING! Damage to the outer sheath may interfere with proper cable operation and will cause the inner cable to rust. Replace a damaged cable as soon as possible to prevent unsafe conditions.**<sup>[EWA10721]</sup>

## **Recommended lubricant:**

Engine oil

## **Checking and lubricating the throttle grip and cable**

The operation of the throttle grip should be checked before each ride. In addition, the cable should be lubricated at the intervals specified in the periodic maintenance chart.

# PERIODIC MAINTENANCE AND ADJUSTMENT

EAU44271

## Checking and lubricating the brake and shift pedals

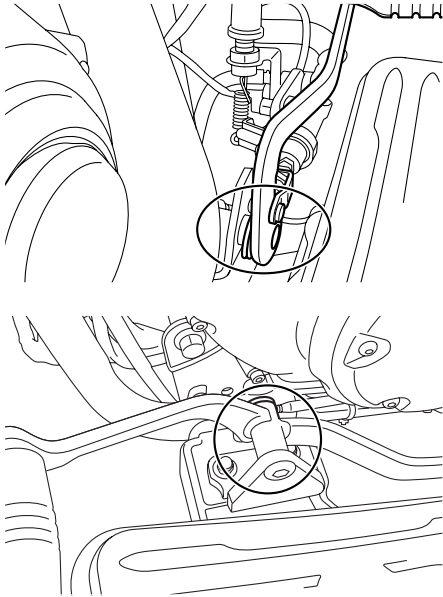

The operation of the brake and shift pedals should be checked before each ride, and the pedal pivots should be lubricated if necessary.

**Recommended lubricant:**  
Lithium-soap-based grease

EAU23142

## Checking and lubricating the brake and clutch levers

### Brake lever

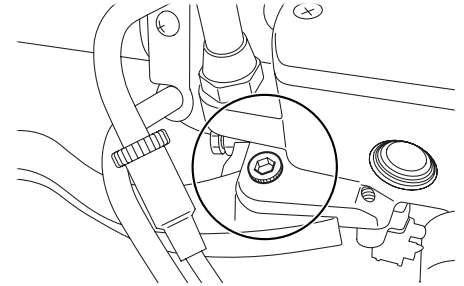

### Clutch lever

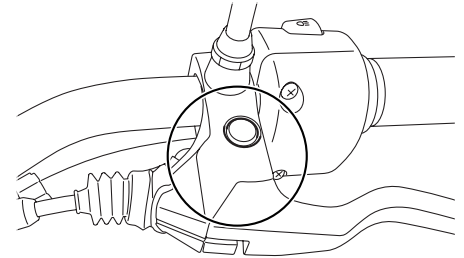

The operation of the brake and clutch levers should be checked before each ride, and the lever pivots should be lu-

# PERIODIC MAINTENANCE AND ADJUSTMENT

bricated if necessary.

## Recommended lubricants:

Brake lever:

Silicone grease

Clutch lever:

Lithium-soap-based grease

## Checking and lubricating the sidestand

EAU23202

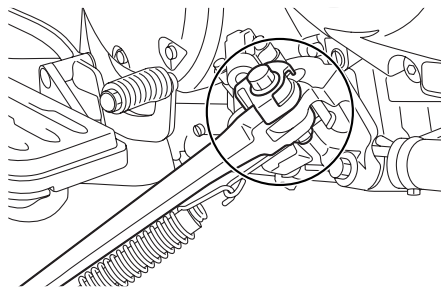

The operation of the sidestand should be checked before each ride, and the sidestand pivot and metal-to-metal contact surfaces should be lubricated if necessary.

EWA10731



**If the sidestand does not move up and down smoothly, have a Yamaha dealer check or repair it. Otherwise, the sidestand could contact the ground and distract the operator, resulting in a possible loss of control.**

## Recommended lubricant:

Lithium-soap-based grease

## Lubricating the rear suspension

EAU23250

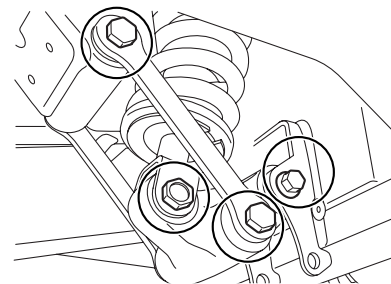

The pivoting points of the rear suspension must be lubricated at the intervals specified in the periodic maintenance and lubrication chart.

## Recommended lubricant:

Lithium-soap-based grease



EAU23272

## Checking the front fork

The condition and operation of the front fork must be checked as follows at the intervals specified in the periodic maintenance and lubrication chart.

### To check the condition

Check the inner tubes for scratches, damage and excessive oil leakage.

### To check the operation

1. Place the vehicle on a level surface and hold it in an upright position. **WARNING! To avoid injury, securely support the vehicle so there is no danger of it falling over.**<sup>[EWA10751]</sup>
2. While applying the front brake, push down hard on the handlebars several times to check if the front fork compresses and rebounds smoothly.

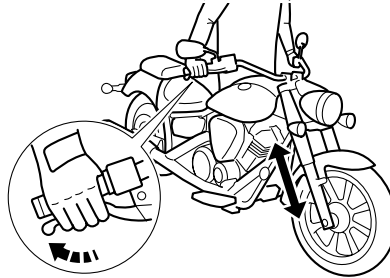

ECA10590

### NOTICE

**If any damage is found or the front fork does not operate smoothly, have a Yamaha dealer check or repair it.**

EAU23283

## Checking the steering

Worn or loose steering bearings may cause danger. Therefore, the operation of the steering must be checked as follows at the intervals specified in the periodic maintenance and lubrication chart.

1. Place a stand under the engine to raise the front wheel off the ground. (See page 7-31 for more information.) **WARNING! To avoid injury, securely support the vehicle so there is no danger of it falling over.**<sup>[EWA10751]</sup>
2. Hold the lower ends of the front fork legs and try to move them forward and backward. If any free play can be felt, have a Yamaha dealer check or repair the steering.

# PERIODIC MAINTENANCE AND ADJUSTMENT

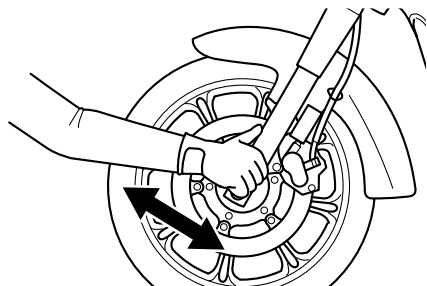

EAU23290

## Checking the wheel bearings

The front and rear wheel bearings must be checked at the intervals specified in the periodic maintenance and lubrication chart. If there is play in the wheel hub or if the wheel does not turn smoothly, have a Yamaha dealer check the wheel bearings.

EAU33654

## Battery

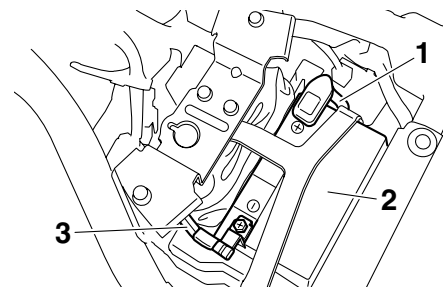

1. Positive battery lead (red)
2. Battery
3. Negative battery lead (black)

This model is equipped with a VRLA (Valve Regulated Lead Acid) battery. There is no need to check the electrolyte or to add distilled water. However, the battery lead connections need to be checked and, if necessary, tightened.

EWA10760

### **WARNING**

- **Electrolyte is poisonous and dangerous since it contains sulfuric acid, which causes severe burns. Avoid any contact with skin, eyes or clothing and always shield your eyes when**

# PERIODIC MAINTENANCE AND ADJUSTMENT

working near batteries. In case of contact, administer the following FIRST AID.

- **EXTERNAL:** Flush with plenty of water.
- **INTERNAL:** Drink large quantities of water or milk and immediately call a physician.
- **EYES:** Flush with water for 15 minutes and seek prompt medical attention.
- Batteries produce explosive hydrogen gas. Therefore, keep sparks, flames, cigarettes, etc., away from the battery and provide sufficient ventilation when charging it in an enclosed space.
- **KEEP THIS AND ALL BATTERIES OUT OF THE REACH OF CHILDREN.**

## To charge the battery

Have a Yamaha dealer charge the battery as soon as possible if it seems to have discharged. Keep in mind that the battery tends to discharge more quickly if the vehicle is equipped with optional

electrical accessories.

ECA16520

### **NOTICE**

To charge a VRLA (Valve Regulated Lead Acid) battery, a special (constant-voltage) battery charger is required. Using a conventional battery charger will damage the battery. If you do not have access to a constant-voltage battery charger, have a Yamaha dealer charge your battery.

## To store the battery

1. If the vehicle will not be used for more than one month, remove the battery, fully charge it, and then place it in a cool, dry place.  
**NOTICE:** When removing the battery, be sure the key is turned to “OFF”, then disconnect the negative lead before disconnecting the positive lead.[ECA16302]
2. If the battery will be stored for more than two months, check it at least once a month and fully charge it if necessary.
3. Fully charge the battery before in-

stallation.

4. After installation, make sure that the battery leads are properly connected to the battery terminals.

ECA16530

### **NOTICE**

Always keep the battery charged. Storing a discharged battery can cause permanent battery damage.

# PERIODIC MAINTENANCE AND ADJUSTMENT

EAU47132

## Replacing the fuses

The main fuse and the fuse box, which contains the fuses for the individual circuits, are located under the rider seat. (See page 4-13.)

### TIP

To access the fuel injection system fuse, remove the starter relay cover by pulling it upward.

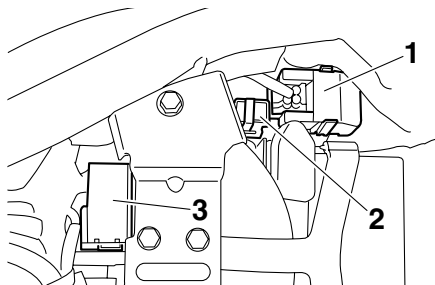

1. Starter relay cover
2. Main fuse
3. Fuse box

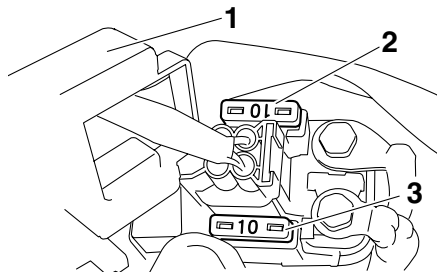

1. Starter relay cover
2. Spare fuse
3. Fuel injection system fuse

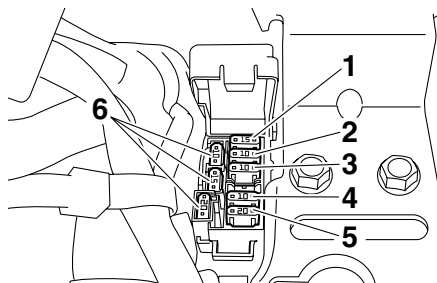

1. Ignition fuse
2. Signaling system fuse
3. Parking lighting fuse
4. Backup fuse
5. Headlight fuse
6. Spare fuse

If a fuse is blown, replace it as follows.

1. Turn the key to "OFF" and turn off the electrical circuit in question.
2. Remove the blown fuse, and then install a new fuse of the specified amperage. **WARNING! Do not use a fuse of a higher amperage rating than recommended to avoid causing extensive damage to the electrical system and possibly a fire.**<sup>[EWA15131]</sup>

### Specified fuses:

- Main fuse:  
40.0 A
- Headlight fuse:  
20.0 A
- Signaling system fuse:  
10.0 A
- Ignition fuse:  
15.0 A
- Parking lighting fuse:  
10.0 A
- Fuel injection system fuse:  
10.0 A
- Backup fuse:  
10.0 A

3. Turn the key to "ON" and turn on the electrical circuit in question to check if the device operates.

# PERIODIC MAINTENANCE AND ADJUSTMENT

4. If the fuse immediately blows again, have a Yamaha dealer check the electrical system.

## Replacing the headlight bulb

This model is equipped with a quartz bulb headlight. If the headlight bulb burns out, replace it as follows.

### NOTICE

Take care not to damage the following parts:

- **Headlight bulb**

Do not touch the glass part of the headlight bulb to keep it free from oil, otherwise the transparency of the glass, the luminosity of the bulb, and the bulb life will be adversely affected. Thoroughly clean off any dirt and fingerprints on the headlight bulb using a cloth moistened with alcohol or thinner.

- **Headlight lens**

Do not affix any type of tinted film or stickers to the headlight lens.

Do not use a headlight bulb of a wattage higher than specified.

EAU23795

ECA10650

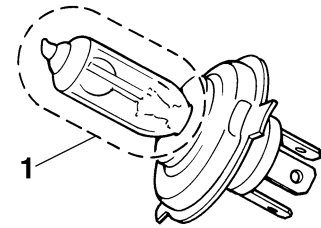

1. Do not touch the glass part of the bulb.

1. Remove the headlight unit by removing the screws.

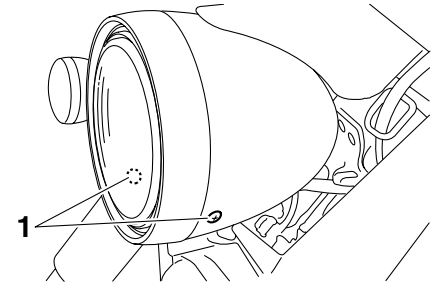

1. Screw

2. Disconnect the headlight coupler, and then remove the bulb cover.

# PERIODIC MAINTENANCE AND ADJUSTMENT

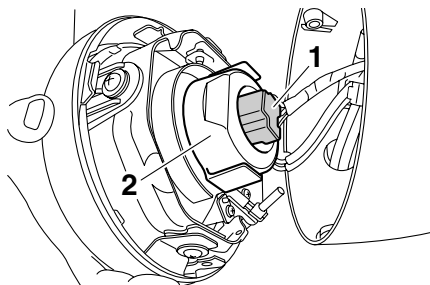

1. Headlight coupler

2. Bulb cover

3. Unhook the headlight bulb holder, and then remove the burnt-out bulb.

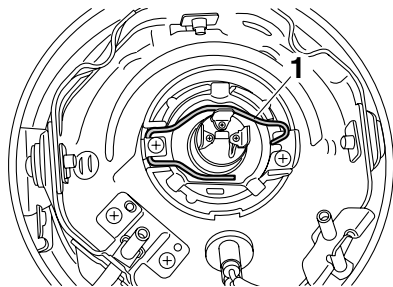

1. Headlight bulb holder

4. Place a new headlight bulb into position, and then secure it with the

bulb holder.

5. Install the headlight bulb cover, and then connect the coupler.
6. Install the headlight unit by installing the screws.
7. Have a Yamaha dealer adjust the headlight beam if necessary.

EAU24133

## Replacing the tail/brake light bulb

1. Remove the tail/brake light lens by removing the screws.

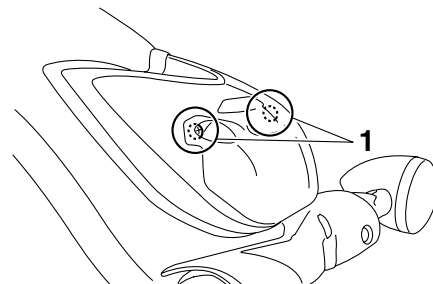

1. Screw

2. Remove the burnt-out bulb by pushing it in and turning it counter-clockwise.

# PERIODIC MAINTENANCE AND ADJUSTMENT

EAU24212

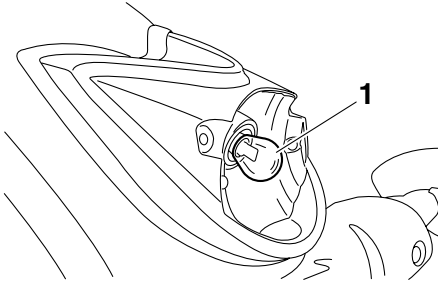

1. Tail/brake light bulb

3. Insert a new bulb into the socket, push it in, and then turn it clockwise until it stops.
4. Install the lens by installing the screws. **NOTICE: Do not over-tighten the screws, otherwise the lens may break.**[ECA10681]

## Replacing a turn signal light bulb

1. Remove the turn signal lens by removing the screws.

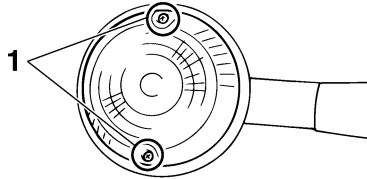

1. Screw

2. Remove the burnt-out bulb by pushing it in and turning it counter-clockwise.

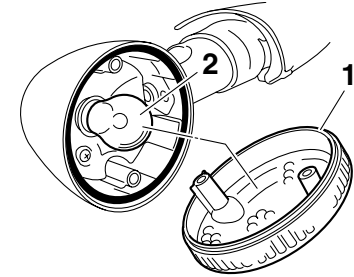

1. Turn signal light lens  
2. Turn signal light bulb

3. Insert a new bulb into the socket, push it in, and then turn it clockwise until it stops.
4. Install the lens by installing the screws. **NOTICE: Do not over-tighten the screws, otherwise the lens may break.**[ECA10681]

# PERIODIC MAINTENANCE AND ADJUSTMENT

EAU24324

## Replacing a license plate light bulb

1. Remove the license plate light unit by removing the nuts, washers and rubber dampers.

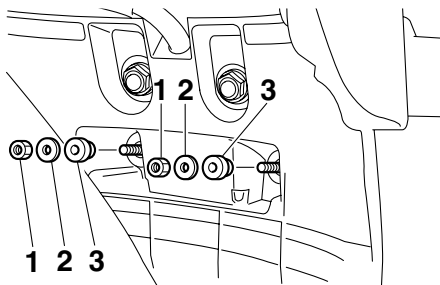

1. Nut
2. Washer
3. Rubber damper

2. Remove the license plate light lens by removing the nuts and washers.

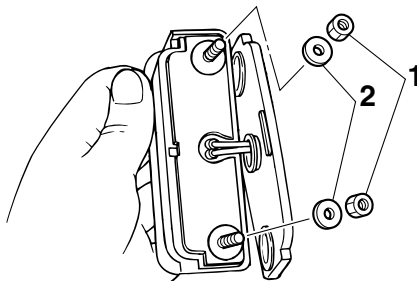

1. Nut
2. Washer

3. Remove the burnt-out bulb by pulling it out.

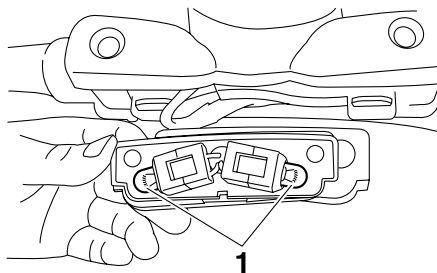

1. License plate light bulb

4. Insert a new bulb into the socket.
5. Install the license plate light lens by installing the washers and the nuts.

6. Install the license plate light unit by installing the rubber dampers, washers and the nuts.



EAU45221

## Replacing an auxiliary light bulb

If the auxiliary light bulb burns out, replace it as follows.

1. Remove the headlight unit. (See page 7-27.)
2. Remove the auxiliary light socket (together with the bulb) by pulling it out.

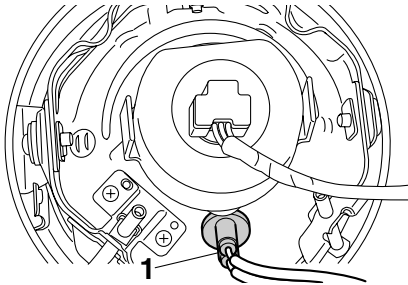

1. Auxiliary light bulb socket

3. Remove the burnt out bulb by pulling it out.

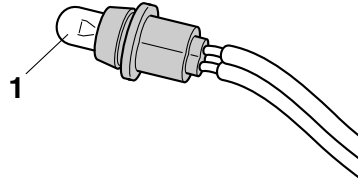

1. Auxiliary light bulb

4. Insert a new bulb into the socket.
5. Install the auxiliary light socket (together with the bulb) by pushing it in.
6. Install the headlight unit.

EAU24350

## Supporting the motorcycle

Since this model is not equipped with a centerstand, follow these precautions when removing the front and rear wheel or performing other maintenance requiring the motorcycle to stand upright. Check that the motorcycle is in a stable and level position before starting any maintenance. A strong wooden box can be placed under the engine for added stability.

### To service the front wheel

1. Stabilize the rear of the motorcycle by using a motorcycle stand or, if an additional motorcycle stand is not available, by placing a jack under the frame in front of the rear wheel.
2. Raise the front wheel off the ground by using a motorcycle stand.

### To service the rear wheel

Raise the rear wheel off the ground by using a motorcycle stand or, if a motorcycle stand is not available, by placing a jack either under each side of the

# PERIODIC MAINTENANCE AND ADJUSTMENT

---

frame in front of the rear wheel or under each side of the swingarm.

EAU25851

## Troubleshooting

Although Yamaha motorcycles receive a thorough inspection before shipment from the factory, trouble may occur during operation. Any problem in the fuel, compression, or ignition systems, for example, can cause poor starting and loss of power.

The following troubleshooting chart represents a quick and easy procedure for checking these vital systems yourself. However, should your motorcycle require any repair, take it to a Yamaha dealer, whose skilled technicians have the necessary tools, experience, and know-how to service the motorcycle properly.

Use only genuine Yamaha replacement parts. Imitation parts may look like Yamaha parts, but they are often inferior, have a shorter service life and can lead to expensive repair bills.

EWA15141



**When checking the fuel system, do not smoke, and make sure there are no open flames or sparks in the area, including pilot lights from water**

**heaters or furnaces. Gasoline or gasoline vapors can ignite or explode, causing severe injury or property damage.**

---

## Troubleshooting chart

### 1. Fuel

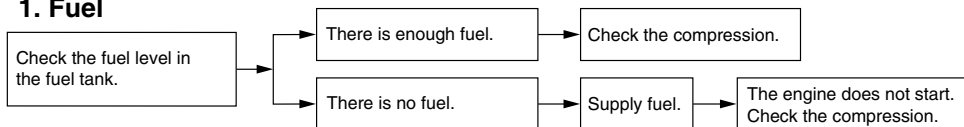

### 2. Compression

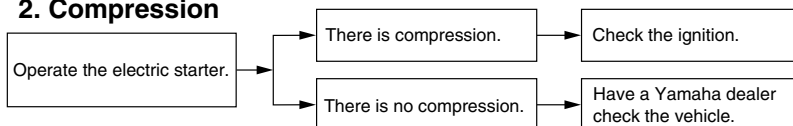

### 3. Ignition

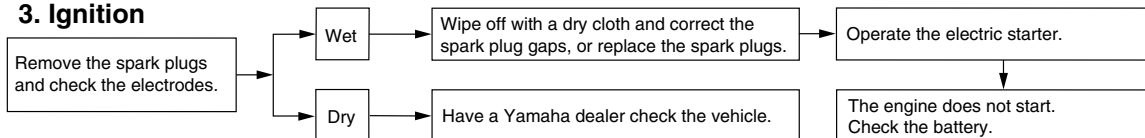

### 4. Battery

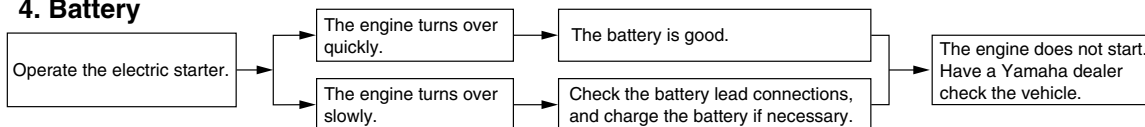

# MOTORCYCLE CARE AND STORAGE

---

## Matte color caution

EAU37833

EAU26074

### **NOTICE**

Some models are equipped with matte colored finished parts. Be sure to consult a Yamaha dealer for advice on what products to use before cleaning the vehicle. Using a brush, harsh chemical products or cleaning compounds when cleaning these parts will scratch or damage their surface. Wax also should not be applied to any matte colored finished parts.

---

ECA15192

## Care

While the open design of a motorcycle reveals the attractiveness of the technology, it also makes it more vulnerable. Rust and corrosion can develop even if high-quality components are used. A rusty exhaust pipe may go unnoticed on a car, however, it detracts from the overall appearance of a motorcycle. Frequent and proper care does not only comply with the terms of the warranty, but it will also keep your motorcycle looking good, extend its life and optimize its performance.

## Before cleaning

1. Cover the muffler outlet with a plastic bag after the engine has cooled down.
2. Make sure that all caps and covers as well as all electrical couplers and connectors, including the spark plug caps, are tightly installed.
3. Remove extremely stubborn dirt, like oil burnt onto the crankcase, with a degreasing agent and a brush, but never apply such prod-

ucts onto seals, gaskets, the drive belt and wheel axles. Always rinse the dirt and degreaser off with water.

## Cleaning

ECA10772

### **NOTICE**

- Avoid using strong acidic wheel cleaners, especially on spoked wheels. If such products are used on hard-to-remove dirt, do not leave the cleaner on the affected area any longer than instructed. Also, thoroughly rinse the area off with water, immediately dry it, and then apply a corrosion protection spray.
- Improper cleaning can damage plastic parts (such as cowlings, panels, windshields, headlight lenses, meter lenses, etc.) and the mufflers. Use only a soft, clean cloth or sponge with water to clean plastic. However, if the plastic parts cannot be thoroughly cleaned with water, diluted mild detergent with water may be used. Be sure to rinse

# MOTORCYCLE CARE AND STORAGE

off any detergent residue using plenty of water, as it is harmful to plastic parts.

- Do not use any harsh chemical products on plastic parts. Be sure to avoid using cloths or sponges which have been in contact with strong or abrasive cleaning products, solvent or thinner, fuel (gasoline), rust removers or inhibitors, brake fluid, antifreeze or electrolyte.
- Do not use high-pressure washers or steam-jet cleaners since they cause water seepage and deterioration in the following areas: seals (of wheel and swing-arm bearings, fork and brakes), electric components (couplers, connectors, instruments, switches and lights), breather hoses and vents.
- For motorcycles equipped with a windshield: Do not use strong cleaners or hard sponges as they will cause dulling or scratching. Some cleaning compounds for plastic may leave

scratches on the windshield. Test the product on a small hidden part of the windshield to make sure that it does not leave any marks. If the windshield is scratched, use a quality plastic polishing compound after washing.

## After normal use

Remove dirt with warm water, a mild detergent, and a soft, clean sponge, and then rinse thoroughly with clean water. Use a toothbrush or bottlebrush for hard-to-reach areas. Stubborn dirt and insects will come off more easily if the area is covered with a wet cloth for a few minutes before cleaning.

## After riding in the rain, near the sea or on salt-sprayed roads

Since sea salt or salt sprayed on roads during winter are extremely corrosive in combination with water, carry out the following steps after each ride in the rain, near the sea or on salt-sprayed roads.

## TIP

Salt sprayed on roads in the winter may remain well into spring.

1. Clean the motorcycle with cold water and a mild detergent, after the engine has cooled down.  
**NOTICE: Do not use warm water since it increases the corrosive action of the salt.**[ECA10791]
2. After drying the motorcycle, apply a corrosion protection spray on all metal, including chrome- and nickel-plated, surfaces to prevent corrosion.

## After cleaning

1. Dry the motorcycle with a chamois or an absorbing cloth.
2. Use a chrome polish to shine chrome, aluminum and stainless-steel parts, including the exhaust system. (Even the thermally induced discoloring of stainless-steel exhaust systems can be removed through polishing.)
3. To prevent corrosion, it is recommended to apply a corrosion pro-

# MOTORCYCLE CARE AND STORAGE

---

tection spray on all metal, including chrome- and nickel-plated, surfaces.

4. Use spray oil as a universal cleaner to remove any remaining dirt.
5. Touch up minor paint damage caused by stones, etc.
6. Wax all painted and chrome-plated surfaces. Avoid combination cleaner waxes, many of which contain abrasives that may mar the paint or protective finish.
7. Let the motorcycle dry completely before storing or covering it.

EWA11131

## WARNING

**Contaminants on the brakes or tires can cause loss of control.**

- **Make sure that there is no oil or wax on the brakes or tires.**
- **If necessary, clean the brake discs and brake linings with a regular brake disc cleaner or acetone, and wash the tires with warm water and a mild detergent. Before riding at higher speeds, test the motorcycle's braking performance and cor-**

**nering behavior.**

ECA10950

## NOTICE

- **Apply spray oil and wax sparingly and make sure to wipe off any excess.**
- **Never apply oil or wax to the drive belt.**
- **Never apply oil or wax to any rubber and plastic parts, but treat them with a suitable care product.**
- **Avoid using abrasive polishing compounds as they will wear away the paint.**

## TIP

- Consult a Yamaha dealer for advice on what products to use.
- Washing, rainy weather or humid climates can cause the headlight lens to fog. Turning the headlight on for a short period of time will help remove the moisture from the lens.

EAU26281

## Storage

### Short-term

Always store your motorcycle in a cool, dry place and, if necessary, protect it against dust with a porous cover.

ECA10810

## NOTICE

- **Storing the motorcycle in a poorly ventilated room or covering it with a tarp, while it is still wet, will allow water and humidity to seep in and cause rust.**
- **To prevent corrosion, avoid damp cellars, stables (because of the presence of ammonia) and areas where strong chemicals are stored.**

### Long-term

Before storing your motorcycle for several months:

1. Follow all the instructions in the "Care" section of this chapter.
2. Fill up the fuel tank and add fuel stabilizer (if available) to prevent the fuel tank from rusting and the

- fuel from deteriorating.
3. Perform the following steps to protect the cylinders, piston rings, etc. from corrosion.
    - a. Remove the spark plug caps and spark plugs.
    - b. Pour a teaspoonful of engine oil into each spark plug bore.
    - c. Install the spark plug caps onto the spark plugs, and then place the spark plugs on the cylinder head so that the electrodes are grounded. (This will limit sparking during the next step.)
    - d. Turn the engine over several times with the starter. (This will coat the cylinder walls with oil.)  
**WARNING! To prevent damage or injury from sparking, make sure to ground the spark plug electrodes while turning the engine over.**<sup>[EWA10951]</sup>
    - e. Remove the spark plug caps from the spark plugs, and then install the spark plugs and the spark plug caps.
  4. Lubricate all control cables and the

pivoting points of all levers and pedals as well as of the sidestand/centerstand.

5. Check and, if necessary, correct the tire air pressure, and then lift the motorcycle so that both of its wheels are off the ground. Alternatively, turn the wheels a little every month in order to prevent the tires from becoming degraded in one spot.
6. Cover the muffler outlet with a plastic bag to prevent moisture from entering it.
7. Remove the battery and fully charge it. Store it in a cool, dry place and charge it once a month. Do not store the battery in an excessively cold or warm place [less than 0 °C (30°F) or more than 30 °C (90°F)]. For more information on storing the battery, see page 7-24.

## TIP

Make any necessary repairs before storing the motorcycle.

# SPECIFICATIONS

## Dimensions:

Overall length:  
2435 mm (95.9 in)  
Overall width:  
1000 mm (39.4 in)  
Overall height:  
1080 mm (42.5 in)  
Seat height:  
675 mm (26.6 in)  
Wheelbase:  
1685 mm (66.3 in)  
Ground clearance:  
145 mm (5.71 in)  
Minimum turning radius:  
3500 mm (137.8 in)

## Weight:

With oil and fuel:  
278.0 kg (613 lb)

## Engine:

Engine type:  
Air cooled 4-stroke, SOHC  
Cylinder arrangement:  
V-type 2-cylinder  
Displacement:  
942.0 cm<sup>3</sup>  
Bore × stroke:  
85.0 × 83.0 mm (3.35 × 3.27 in)  
Compression ratio:  
9.00 :1  
Starting system:  
Electric starter  
Lubrication system:  
Wet sump

## Engine oil:

Type:  
YAMALUBE 4 10W-40 or 20W-50, SAE  
10W-40 or SAE 20W-50

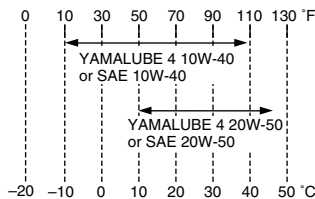

Recommended engine oil grade:  
API service SG type or higher, JASO standard MA

## Engine oil quantity:

Without oil filter cartridge replacement:  
3.70 L (3.91 US qt, 3.26 Imp.qt)  
With oil filter cartridge replacement:  
4.00 L (4.23 US qt, 3.52 Imp.qt)

## Air filter:

Air filter element:  
Oil-coated paper element

## Fuel:

Recommended fuel:  
Unleaded gasoline only  
Fuel tank capacity:  
17.0 L (4.49 US gal, 3.74 Imp.gal)  
Fuel reserve amount:  
3.0 L (0.79 US gal, 0.66 Imp.gal)

## Fuel injection:

Throttle body:  
Type/quantity:  
ACW35/1

## Spark plug (s):

Manufacturer/model:  
NGK/CPR7EA-9  
Spark plug gap:  
0.8–0.9 mm (0.031–0.035 in)

## Clutch:

Clutch type:  
Wet, multiple-disc

## Transmission:

Primary reduction system:  
Spur gear  
Primary reduction ratio:  
72/43 (1.674)  
Secondary reduction system:  
Belt drive  
Secondary reduction ratio:  
70/30 (2.333)  
Transmission type:  
Constant mesh 5-speed  
Operation:  
Left foot operation

## Gear ratio:

1st:  
46/15 (3.067)  
2nd:  
33/16 (2.063)



3rd:  
30/19 (1.579)  
4th:  
34/27 (1.259)  
5th:  
25/24 (1.042)

## Chassis:

Frame type:  
Double cradle  
Caster angle:  
32.10 °  
Trail:  
145.0 mm (5.71 in)

## Front tire:

Type:  
Tubeless  
Size:  
130/70-18M/C 63H  
Manufacturer/model:  
BRIDGESTONE/EXEDRA G721 J  
Manufacturer/model:  
DUNLOP/D404F

## Rear tire:

Type:  
Tubeless  
Size:  
170/70B16M/C 75H  
Manufacturer/model:  
BRIDGESTONE/EXEDRA G722 J  
Manufacturer/model:  
DUNLOP/K555

## Loading:

Maximum load:  
210 kg (463 lb)  
\* (Total weight of rider, passenger, cargo  
and accessories)

## Tire air pressure (measured on cold tires):

Loading condition:  
0–90 kg (0–198 lb)  
Front:  
225 kPa (2.25 kgf/cm<sup>2</sup>, 33 psi)  
Rear:  
250 kPa (2.50 kgf/cm<sup>2</sup>, 36 psi)  
Loading condition:  
90–210 kg (198–463 lb)  
Front:  
225 kPa (2.25 kgf/cm<sup>2</sup>, 33 psi)  
Rear:  
250 kPa (2.50 kgf/cm<sup>2</sup>, 36 psi)

## Front wheel:

Wheel type:  
Cast wheel  
Rim size:  
18M/C x MT3.50

## Rear wheel:

Wheel type:  
Cast wheel  
Rim size:  
16M/C x MT4.50

## Front brake:

Type:  
Single disc brake

Operation:  
Right hand operation  
Recommended fluid:  
DOT 4

## Rear brake:

Type:  
Single disc brake  
Operation:  
Right foot operation  
Recommended fluid:  
DOT 4

## Front suspension:

Type:  
Telescopic fork  
Spring/shock absorber type:  
Coil spring/oil damper  
Wheel travel:  
135.0 mm (5.31 in)

## Rear suspension:

Type:  
Swingarm  
Spring/shock absorber type:  
Coil spring/gas-oil damper  
Wheel travel:  
110.0 mm (4.33 in)

## Electrical system:

Ignition system:  
TCI (digital)  
Charging system:  
AC magneto

## Battery:

Model:  
YTZ14S

# SPECIFICATIONS

---

Voltage, capacity:  
12 V, 11.2 Ah

## Headlight:

Bulb type:  
Halogen bulb

## Bulb voltage, wattage × quantity:

Headlight:

12 V, 60 W/55 W × 1

Tail/brake light:

12 V, 5.0 W/21.0 W × 1

Front turn signal light:

12 V, 21.0 W × 1

Rear turn signal light:

12 V, 21.0 W × 2

Meter lighting:

LED

Neutral indicator light:

LED

High beam indicator light:

LED

Oil level warning light:

LED

Turn signal indicator light:

LED

Fuel level warning light:

LED

Engine trouble warning light:

LED

Immobilizer system indicator light:

LED

## Fuses:

Main fuse:  
40.0 A

Headlight fuse:  
20.0 A

Signaling system fuse:  
10.0 A

Ignition fuse:  
15.0 A

Parking lighting fuse:  
10.0 A

Fuel injection system fuse:  
10.0 A

Backup fuse:  
10.0 A

EAU26351

## Identification numbers

Record the key identification number, vehicle identification number and model label information in the spaces provided below for assistance when ordering spare parts from a Yamaha dealer or for reference in case the vehicle is stolen.

KEY IDENTIFICATION NUMBER:

VEHICLE IDENTIFICATION NUMBER:

MODEL LABEL INFORMATION:

EAU26381

## Key identification number

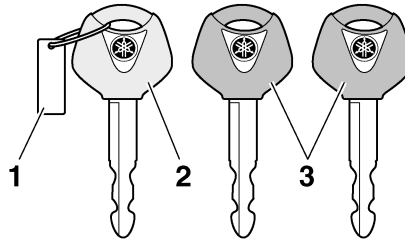

1. Key identification number
2. Code re-registering key (red bow)
3. Standard keys (black bow)

The key identification number is stamped into the key tag. Record this number in the space provided and use it for reference when ordering a new key.

EAU26400

## Vehicle identification number

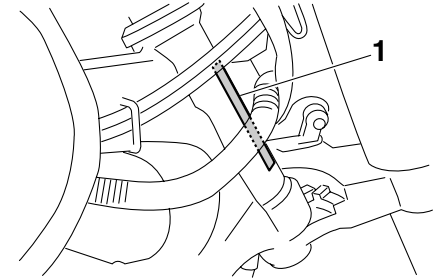

1. Vehicle identification number

The vehicle identification number is stamped into the steering head pipe. Record this number in the space provided.

**TIP** \_\_\_\_\_  
The vehicle identification number is used to identify your motorcycle and may be used to register your motorcycle with the licensing authority in your area.

\_\_\_\_\_

# CONSUMER INFORMATION

EAU26470

EAU26570

## Model label

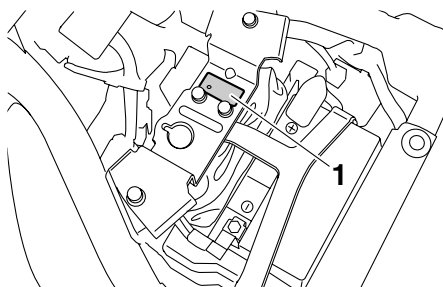

1. Model label

The model label is affixed to the frame under the rider seat. (See page 4-13.) Record the information on this label in the space provided. This information will be needed when ordering spare parts from a Yamaha dealer.

## Motorcycle noise regulation (for Australia)

### TAMPERING WITH NOISE CONTROL SYSTEM PROHIBITED:

Owners are warned that the law may prohibit:

- The removal or rendering inoperative by any person other than for purposes of maintenance, repair or replacement, of any device or element of design incorporated into any new vehicle for the purpose of noise control prior to its sale or delivery to the ultimate purchaser or while it is in use; and
- The use of the vehicle after such device or element of design has been removed or rendered inoperative by any person.

- A**
- Air filter element, replacing ..... 7-11
  - Auxiliary light bulb, replacing ..... 7-31
- B**
- Battery ..... 7-24
  - Brake and clutch levers, checking and lubricating ..... 7-21
  - Brake and shift pedals, checking and lubricating ..... 7-21
  - Brake fluid, changing ..... 7-18
  - Brake fluid level, checking ..... 7-17
  - Brake lever ..... 4-10
  - Brake lever free play, adjusting ..... 7-15
  - Brake pedal ..... 4-10
- C**
- Cables, checking and lubricating ..... 7-20
  - Care ..... 8-1
  - Catalytic converter ..... 4-12
  - Clutch lever ..... 4-9
  - Clutch lever free play, adjusting ..... 7-14
- D**
- Dimmer switch ..... 4-8
  - Drive belt slack ..... 7-18
- E**
- Engine break-in ..... 6-3
  - Engine idling speed, checking ..... 7-11
  - Engine oil and oil filter cartridge ..... 7-7
  - Engine stop switch ..... 4-8
  - Engine trouble warning light ..... 4-4
- F**
- Front and rear brake pads, checking ..... 7-16
  - Front fork, checking ..... 7-23
  - Fuel ..... 4-11
  - Fuel consumption, tips for reducing ..... 6-3
  - Fuel level warning light ..... 4-4
  - Fuel tank cap ..... 4-10
  - Fuses, replacing ..... 7-26
- H**
- Handlebar switches ..... 4-7
  - Hazard switch ..... 4-8
  - Headlight bulb, replacing ..... 7-27
  - Helmet holder ..... 4-14
  - High beam indicator light ..... 4-3
  - Horn switch ..... 4-8
- I**
- Identification numbers ..... 10-1
  - Ignition circuit cut-off system ..... 4-16
  - Immobilizer system ..... 4-1
  - Immobilizer system indicator light ..... 4-4
  - Indicator and warning lights ..... 4-3
- K**
- Key identification number ..... 10-1
- L**
- Labels, location ..... 1-1
  - License plate light bulb, replacing ..... 7-30
- M**
- Main switch/steering lock ..... 4-2
  - Maintenance and lubrication, periodic ..... 7-3
  - Maintenance, emission control system ..... 7-2
  - Matte color, caution ..... 8-1
  - Model label ..... 10-2
  - Multi-function meter unit ..... 4-4
- N**
- Neutral indicator light ..... 4-3
  - Noise regulation (for Australia) ..... 10-2
- O**
- Oil level warning light ..... 4-3
- P**
- Panel, removing and installing ..... 7-6
  - Parking ..... 6-4
  - Part locations ..... 3-1
  - Pass switch ..... 4-8
- R**
- Rear brake light switch, adjusting ..... 7-16
  - Rear suspension, lubricating ..... 7-22
  - RESET switch ..... 4-9
  - Rider seat ..... 4-13
- S**
- Safety information ..... 2-1
  - SELECT switch ..... 4-8
  - Shifting ..... 6-2
  - Shift pedal ..... 4-9
  - Shock absorber assembly, adjusting ..... 4-14
  - Sidestand ..... 4-16
  - Sidestand, checking and lubricating ..... 7-22
  - Spark plugs, checking ..... 7-6
  - Specifications ..... 9-1
  - Starting the engine ..... 6-1
  - Start switch ..... 4-8
  - Steering, checking ..... 7-23
  - Storage ..... 8-3
  - Supporting the motorcycle ..... 7-31
- T**
- Tail/brake light bulb, replacing ..... 7-28
  - Throttle cable free play, checking ..... 7-12
  - Throttle grip and cable, checking and lubricating ..... 7-20
  - Tires ..... 7-12
  - Tool kit ..... 7-1
  - Troubleshooting ..... 7-32
  - Troubleshooting chart ..... 7-33

# INDEX

---

---

Turn signal indicator light .....	4-3
Turn signal light bulb, replacing .....	7-29
Turn signal switch .....	4-8

## V

Valve clearance .....	7-12
Vehicle identification number .....	10-1

## W

Wheel bearings, checking .....	7-24
Wheels .....	7-14





PRINTED ON RECYCLED PAPER

PRINTED IN JAPAN  
2008.10-0.2×1   
(E)