



OWNER'S MANUAL

YZF-R6

YZF-R6M

5EB-28199-21

Congratulations on your purchase of the Yamaha YZF-R6. This model is the result of Yamaha's vast experience in the production of fine sporting, touring, and pacesetting racing machines. It represents the high degree of craftsmanship and reliability that have made Yamaha a leader in these fields.

This manual will give you an understanding of the operation, inspection, and basic maintenance of this motorcycle. If you have any questions about the operation or maintenance of your motorcycle, please consult a Yamaha dealer.

IMPORTANT MANUAL INFORMATION

Particularly important information is distinguished in this manual by the following notations:



The Safety Alert Symbol means ATTENTION! BECOME ALERT! YOUR SAFETY IS INVOLVED!



Failure to follow WARNING instructions could result in severe injury or death to the motorcycle operator, a bystander or a person inspecting or repairing the motorcycle.

CAUTION:

A CAUTION indicates special precautions that must be taken to avoid damage to the motorcycle.

NOTE:

A NOTE provides key information to make procedures easier or clearer.

NOTE:

- This manual should be considered a permanent part of this motorcycle and should remain with it even if the motorcycle is subsequently sold.
 - Yamaha continually seeks advancements in product design and quality. Therefore, while this manual contains the most current product information available at the time of printing, there may be minor discrepancies between your motorcycle and this manual. If there is any question concerning this manual, please consult your Yamaha dealer.
-

IMPORTANT MANUAL INFORMATION

EW000002



PLEASE READ THIS MANUAL CAREFULLY AND COMPLETELY BEFORE OPERATING THIS MOTORCYCLE.

IMPORTANT MANUAL INFORMATION

EAU00008

YZF-R6M

OWNER'S MANUAL

© 1999 by Yamaha Motor Co., Ltd.

1st Edition, September 1999

**All rights reserved. Any reprinting or
unauthorized use without the written
permission of Yamaha Motor Co., Ltd.
is expressly prohibited.**

Printed in Japan.

1 SAFETY INFORMATION	1
2 DESCRIPTION	2
3 INSTRUMENT AND CONTROL FUNCTIONS	3
4 PRE-OPERATION CHECKS	4
5 OPERATION AND IMPORTANT RIDING POINTS	5
6 PERIODIC MAINTENANCE AND MINOR REPAIR	6
7 MOTORCYCLE CARE AND STORAGE	7
8 SPECIFICATIONS	8
9 CONSUMER INFORMATION	9
INDEX	

Safe riding 1-1
Protective apparel 1-3
Modification 1-3
Loading and accessories 1-3
Gasoline and exhaust gas..... 1-5
Location of the important labels 1-7



TWO-WHEELED MOTORCYCLES ARE SINGLE TRACK VEHICLES. THEIR SAFE USE AND OPERATION ARE DEPENDENT UPON THE USE OF PROPER RIDING TECHNIQUES AS WELL AS THE EXPERTISE OF THE OPERATOR.

EVERY OPERATOR SHOULD KNOW THE FOLLOWING REQUIREMENTS BEFORE RIDING. HE OR SHE SHOULD:

1. OBTAIN THOROUGH INSTRUCTIONS FROM A COMPETENT SOURCE ON ALL ASPECTS OF MOTORCYCLE OPERATION.
2. OBSERVE THE WARNINGS AND MAINTENANCE REQUIREMENTS IN THE OWNER'S MANUAL.
3. OBTAIN QUALIFIED TRAINING IN SAFE AND PROPER RIDING TECHNIQUES.
4. OBTAIN PROFESSIONAL TECHNICAL SERVICE AS INDICATED BY THE OWNER'S MANUAL AND/OR WHEN MADE NECESSARY BY MECHANICAL CONDITIONS.

Safe riding

1. Always make pre-operation checks. Careful checks may help prevent an accident.
2. This motorcycle is designed to carry the operator and a passenger.
3. The failure of motorists to detect and recognize motorcycles in traffic is the predominating cause of automobile/motorcycle accidents. Many accidents have been caused by an automobile driver who did not see the motorcycle. Making yourself conspicuous appears to be very effective in reducing the chance of this type of accident.

Therefore:

- a. Wear a brightly colored jacket.
- b. Use extra caution when you approach and pass through intersections, since intersections are the most likely places for motorcycle accidents.
- c. Ride where other motorists can see you. Avoid riding in another motorist's "blind spot".

4. Many accidents involve inexperienced operators. In fact, many operators who have been involved in accidents do not even have a current motorcycle license.
 - a. Make sure you are qualified. Also, only lend your motorcycle to experienced operators.
 - b. Know your skills and limits. Staying within your limits may help you to avoid an accident.
 - c. We recommend that you practice riding your motorcycle where there is no traffic until you have become thoroughly familiar with your motorcycle and all of its controls.
5. Many motorcycle accidents have been caused by motorcycle operator errors. A typical error made by the operator is veering wide on a turn due to EXCESSIVE SPEED or undercornering (insufficient lean angle for the speed).
 - a. Always obey the speed limits and never travel faster than warranted by road and traffic conditions.
 - b. Always signal before turning or changing lanes. Make sure other motorists see you.
6. The operator's and passenger's posture are important for proper control.
 - a. The operator should keep both hands on the handlebars and both feet on the operator footrests during operation to maintain control of the motorcycle.
 - b. The passenger should always hold on to the operator, or the seat strap or grab bar if the motorcycle is so equipped, with both hands and keep both feet on the passenger footrests.
 - c. Never carry a passenger unless he or she can firmly place both feet on the passenger footrests.
7. Never ride under the influence of alcohol or drugs.
8. This motorcycle is designed for on-road use only. It is not suitable for off-road use.



SAFETY INFORMATION

1

Protective apparel

The majority of fatalities from motorcycle accidents are the result of head injuries. The use of a safety helmet is the single most critical factor in the prevention or reduction of head injuries.

1. Always wear an approved helmet.
2. Wear a face shield or goggles. Wind on your unprotected eyes could contribute to an impairment of vision which could delay seeing a hazard.
3. The use of heavy boots, jacket, trousers, gloves, etc. is effective in preventing or reducing abrasions or lacerations.
4. Never wear loose fitting clothing. It could catch on the control levers, footrests, or wheels and cause injury or accident.
5. Never touch the engine or exhaust system during or after operation. They become very hot and can cause burns. Always wear protective clothing that covers your legs, ankles, and feet.
6. A passenger should also observe the above precautions.

Modification

Modifications made to the motorcycle not approved by Yamaha, or the removal of original equipment, may render your motorcycle unsafe for use and may cause severe personal injury. Modifications may also make your motorcycle illegal to use.

Loading and accessories

Adding accessories or cargo to your motorcycle can adversely affect stability and handling if the weight distribution of the machine is changed. To avoid the possibility of an accident, extreme caution should be used if adding cargo or accessories to your motorcycle. Use extra care if riding a motorcycle which has added cargo or accessories. Here are some general guidelines to follow if loading cargo or adding accessories to your motorcycle:

Loading

The total weight of the operator, passenger, accessories and cargo must not exceed the maximum load limit of 187 kg.

When loading within these weight limits, keep the following in mind:

1. Cargo and accessory weight should be kept as low and close to the motorcycle as possible. Be sure to distribute the weight as evenly as possible on both sides of the machine to minimize imbalance or instability.
2. Shifting weights can create a sudden imbalance. Make sure that accessories and cargo are securely attached to the motorcycle before riding. Recheck accessory mounts and cargo restraints frequently.
3. Never attach any large or heavy items to the handlebars, front forks, or front fender. These items, including such cargo as sleeping bags, duffle bags, or tents, can create unstable handling or slow steering response.

Accessories

Genuine Yamaha accessories have been specifically designed for use on this motorcycle. Since Yamaha cannot test all other accessories which may be available, you must personally be responsible for the proper selection, installation and use of non-Yamaha accessories. You should use extreme caution when selecting and installing any accessories.

Keep in mind these guidelines for mounting accessories in addition to those provided under “LOADING”.

1. Never install accessories or carry cargo that would impair the performance of your motorcycle. Carefully inspect the accessory before using it to make sure it does not in any way reduce ground clearance or cornering clearance, limit suspension travel, steering travel or control operation, or obscure lights or reflectors.



SAFETY INFORMATION

1

- a. Accessories fitted to the handlebar or the front fork area can create instability due to improper weight distribution or aerodynamic changes. If accessories are added to the handlebar or front fork area, they must be as lightweight as possible and should be kept to a minimum.
 - b. Bulky or large accessories may seriously affect the stability of the motorcycle due to aerodynamic effects. Wind may attempt to lift the motorcycle, or the motorcycle may become unstable in cross winds. These accessories may also cause instability when being passed by or passing large vehicles.
 - c. Certain accessories can displace the operator from his or her normal riding position. This improper position limits the freedom of movement of the operator and may limit control ability. Therefore such accessories are not recommended.
2. Caution must be used if adding electrical accessories. If these accessories exceed the capacity of the motorcycle's electrical system, an electric failure could result, which could cause a dangerous loss of lights or engine power.

Gasoline and exhaust gas

1. GASOLINE IS HIGHLY FLAMMABLE:
 - a. Always turn off the engine when refueling.
 - b. Take care not to spill any gasoline on the engine or exhaust system when refueling.
 - c. Never refuel while smoking or in the vicinity of an open flame.
2. Never start the engine or let it run for any length of time in a closed area. The exhaust fumes are poisonous and may cause loss of consciousness and death within a short time. Always operate your motorcycle in an area that has adequate ventilation.
3. Always turn off the engine before leaving the motorcycle unattended and remove the ignition key. When parking the motorcycle, note the following:

- a. The engine and exhaust system may be hot. Park the motorcycle in a place where pedestrians or children are not likely to touch these hot areas.
 - b. Do not park the motorcycle on a slope or soft ground; the motorcycle may fall over.
 - c. Do not park the motorcycle near a flammable source, e.g. a kerosene heater, or near an open flame. The motorcycle could catch fire.
4. When transporting the motorcycle in another vehicle, be sure it is kept upright. If it should lean over, gasoline may leak out of the carburetor or fuel tank.
 5. If you should swallow any gasoline, inhale a lot of gasoline vapor, or allow gasoline to get in your eyes, see your doctor immediately. If any gasoline spills on your skin or clothing, immediately wash it off with soap and water and change your clothes.

SAFETY INFORMATION

EAU02977

Location of the important labels

Please read the following labels carefully before operating this motorcycle.

1

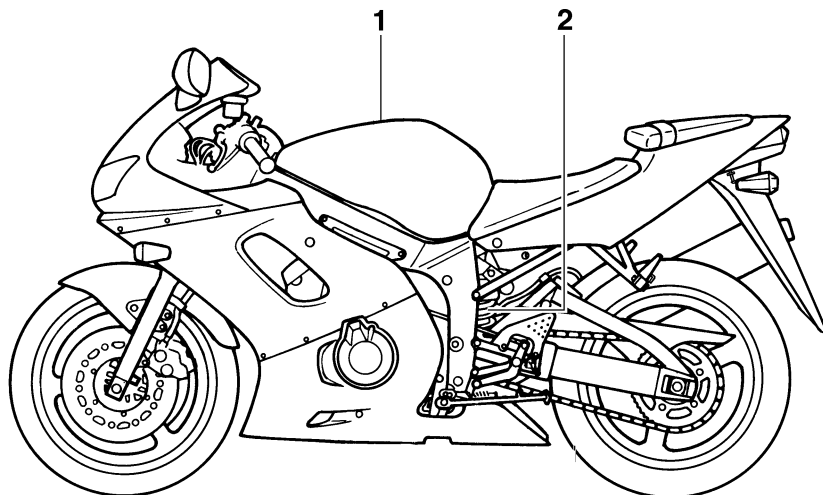

1

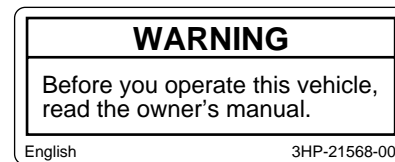

2



Left view	2-1
Right view.....	2-2
Controls/Instruments.....	2-3

Left view

2

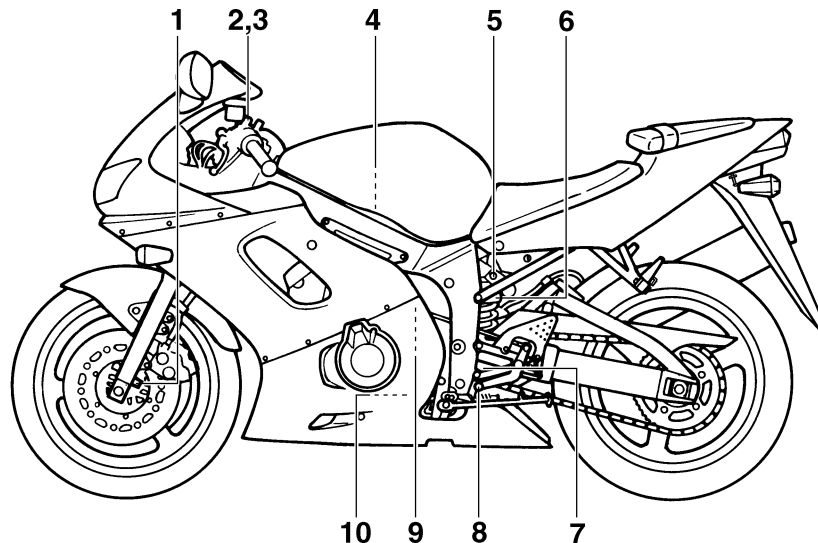

- | | | | |
|--|-------------|---|-------------|
| 1. Front fork compression damping force adjusting screw | (page 3-18) | 6. Rear shock absorber spring preload adjusting ring | (page 3-19) |
| 2. Front fork rebound damping force adjusting screw | (page 3-18) | 7. Rear shock absorber rebound damping force adjusting knob | (page 3-19) |
| 3. Front fork spring preload adjusting bolt | (page 3-17) | 8. Shift pedal | (page 3-11) |
| 4. Air filter | (page 6-17) | 9. Coolant reservoir tank | (page 6-13) |
| 5. Rear shock absorber compression damping force adjusting screw | (page 3-20) | 10. Engine oil filter | (page 6-11) |

Right view

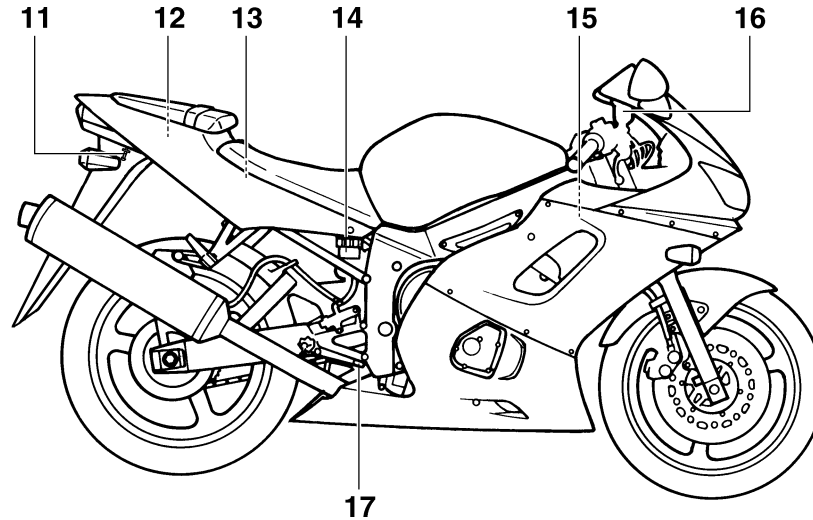

- | | |
|---------------------------------|-------------|
| 11. Luggage strap holders | (page 3-22) |
| 12. Tool kit | (page 6-1) |
| 13. Fuses | (page 6-34) |
| 14. Rear brake fluid reservoir | |
| 15. Radiator cap | (page 6-14) |
| 16. Front brake fluid reservoir | |
| 17. Rear brake pedal | (page 3-12) |

DESCRIPTION

Controls/Instruments

2

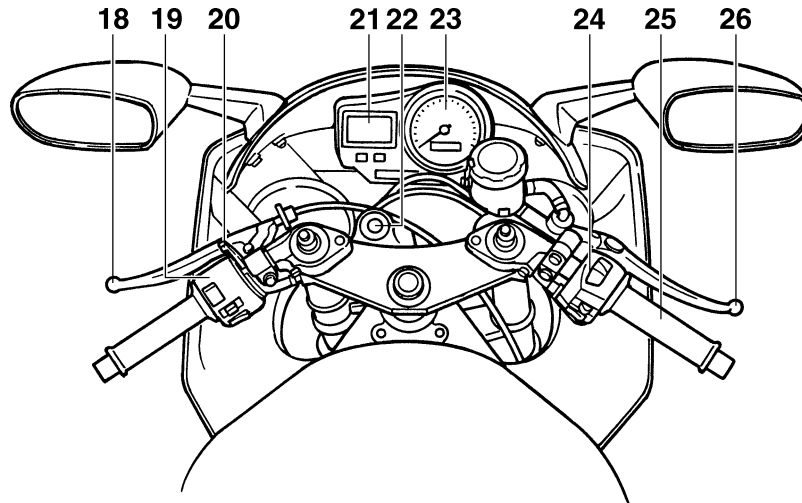

- 18. Clutch lever
- 19. Left handlebar switches
- 20. Starter (choke) “| \ |”
- 21. Digital speedometer
- 22. Main switch

- (page 3-11)
- (page 3-9)
- (page 3-14)
- (page 3-7)
- (page 3-1)

- 23. Tachometer
- 24. Right handlebar switches
- 25. Throttle grip
- 26. Front brake lever

- (page 3-8)
- (page 3-10)
- (page 6-21)
- (page 3-11)

INSTRUMENT AND CONTROL FUNCTIONS

Main switch/steering lock.....	3-1	Fuel tank cap	3-13
Indicator lights	3-2	Fuel	3-13
Oil level/coolant temperature indicator light circuit check.....	3-5	Starter (choke) “ ↘ ”	3-14
Fuel indicator light circuit check.....	3-6	Seats.....	3-15
Digital speedometer.....	3-7	Helmet holder.....	3-16
Tachometer	3-8	Storage compartment	3-16
Diagnosis device.....	3-9	Front fork adjustment	3-17
Handlebar switches	3-9	Rear shock absorber adjustment	3-19
Clutch lever	3-11	Recommended combinations of the front fork and the rear shock absorber settings.....	3-21
Shift pedal.....	3-11	Luggage strap holders	3-22
Front brake lever	3-11	Sidestand	3-22
Rear brake pedal	3-12	Sidestand/clutch switch operation check.....	3-23

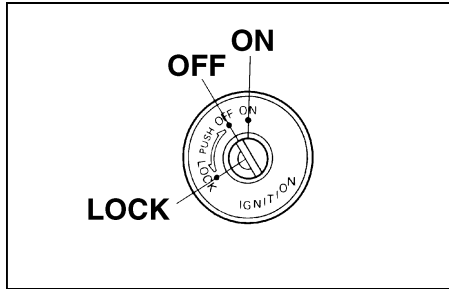

EAU00029*

Main switch/steering lock

The main switch controls the ignition and lighting systems. Its operation is described below.

EAU00030

ON

Electrical circuits are switched on, and the headlight, meter light, and taillight come on. The engine can be started. The key cannot be removed in this position.

EAU00038

OFF

All electrical circuits are switched off. The key can be removed in this position.

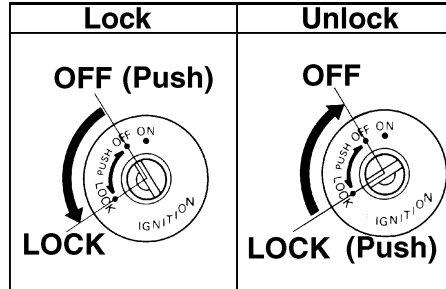

EAU00040

LOCK

The steering is locked in this position and all electrical circuits are switched off. The key can be removed in this position.

To lock the steering, turn the handlebars all the way to the left. While pushing the key into the main switch, turn it from "OFF" to "LOCK" and remove it. To release the lock, turn the key to "OFF" while pushing.

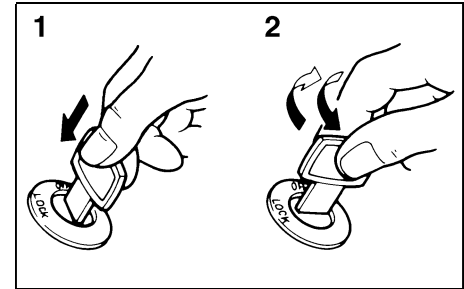

1. Push
2. Turn

EW000016

! WARNING

Never turn the key to "OFF" or "LOCK" when the motorcycle is moving. The electrical circuits will be switched off which may result in loss of control or an accident. Be sure the motorcycle is stopped before turning the key to "OFF" or "LOCK".

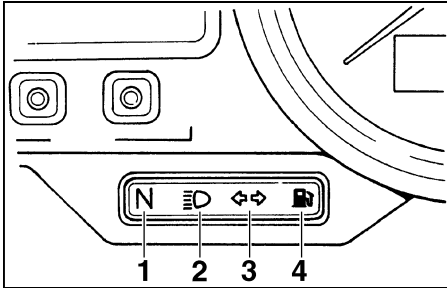

1. Neutral indicator light “N”
2. High beam indicator light “≡○”
3. Turn indicator light “↔”
4. Fuel indicator light “⛽”

EAU00056

Indicator lights

EAU00061

Neutral indicator light “N”

This indicator comes on when the transmission is in neutral.

EAU00063

High beam indicator light “≡○”

This indicator comes on when the headlight high beam is used.

EAU00057

Turn indicator light “↔”

This indicator flashes when the turn switch is moved to the left or right.

EAU01154

Fuel indicator light “⛽”

When the fuel level drops below approximately 3.5 L, this light will come on. When this light comes on, fill the tank at the first opportunity. This light circuit can be checked by the procedure on page 3-6.

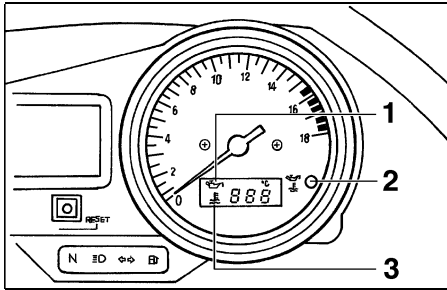

INSTRUMENT AND CONTROL FUNCTIONS



1. Oil level symbol “

EAU01564

Oil level/coolant temperature indicator light “ This indicator light has two functions.

- The light will come on and symbol “
 - The light will come on and symbol “

The light circuit can be checked by the procedure on page 3-5.

EC000118



CAUTION:

- **Do not run the motorcycle until you know it has sufficient engine oil.**
- **Do not run the motorcycle if the engine is overheated.**

NOTE:

Even if the oil is filled to the specified level, the indicator light may flicker when riding on a slope or during sudden acceleration or deceleration, but this is normal.

INSTRUMENT AND CONTROL FUNCTIONS

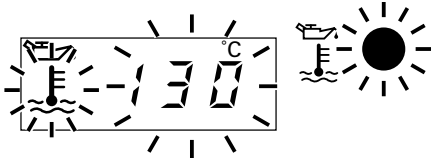
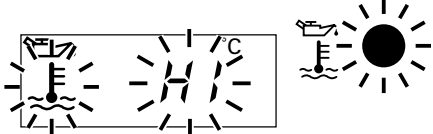
Coolant temperature	Display	Conditions	What to do
0 °C ~ 40 °C		Symbol is on and "LO" is displayed.	OK. Go ahead with riding.
41 °C ~ 117 °C		Symbol is on and temperature is displayed.	OK. Go ahead with riding.
118 °C ~ 140 °C		Symbol and temperature flash. Indicator light comes on.	Stop the motorcycle and allow it to idle until coolant temperature goes down. If the temperature does not go down, stop the engine. See "Engine overheating" in the troubleshooting chart on page 6-42 for instructions.
141 °C ~		Symbol and message "HI" flash. Indicator light comes on.	Stop the engine and allow it to cool. See "Engine overheating" in the troubleshooting chart on page 6-42 for instructions.

INSTRUMENT AND CONTROL FUNCTIONS

EAU02987

Oil level/coolant temperature indicator light circuit check

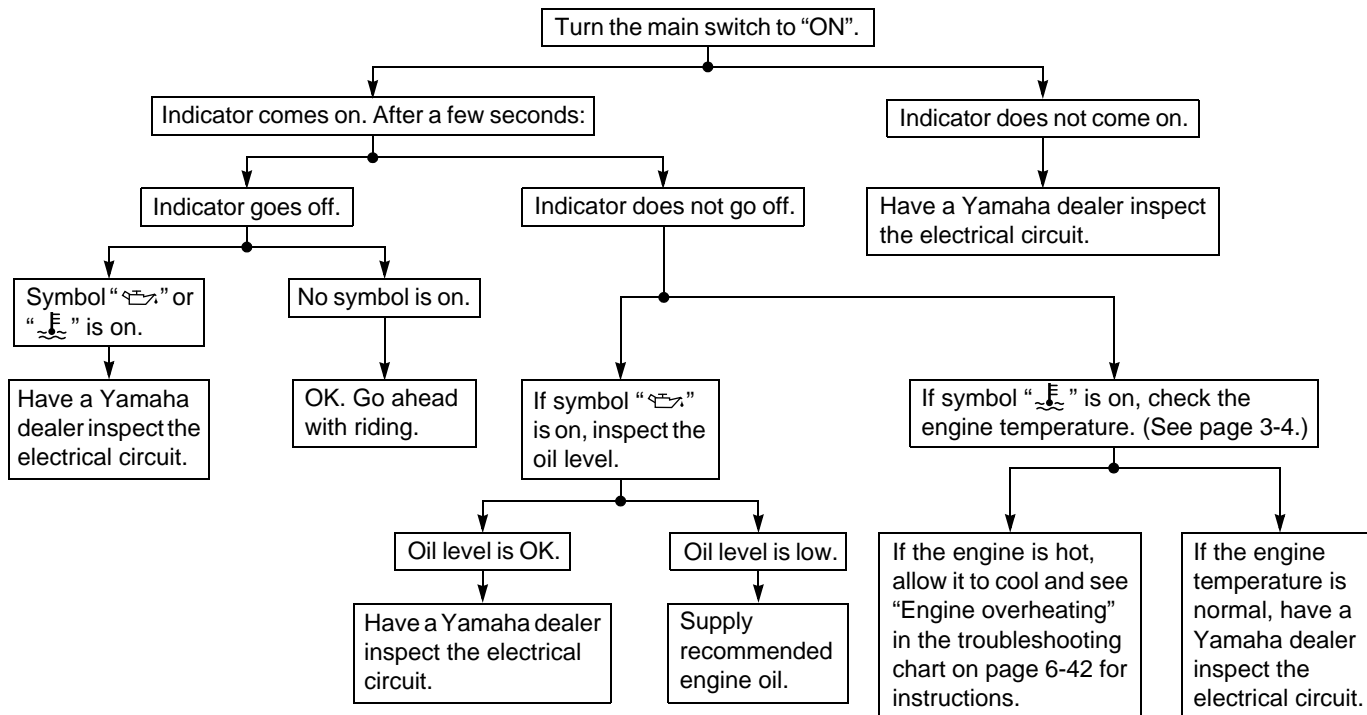

INSTRUMENT AND CONTROL FUNCTIONS

EAU01295

Fuel indicator light circuit check

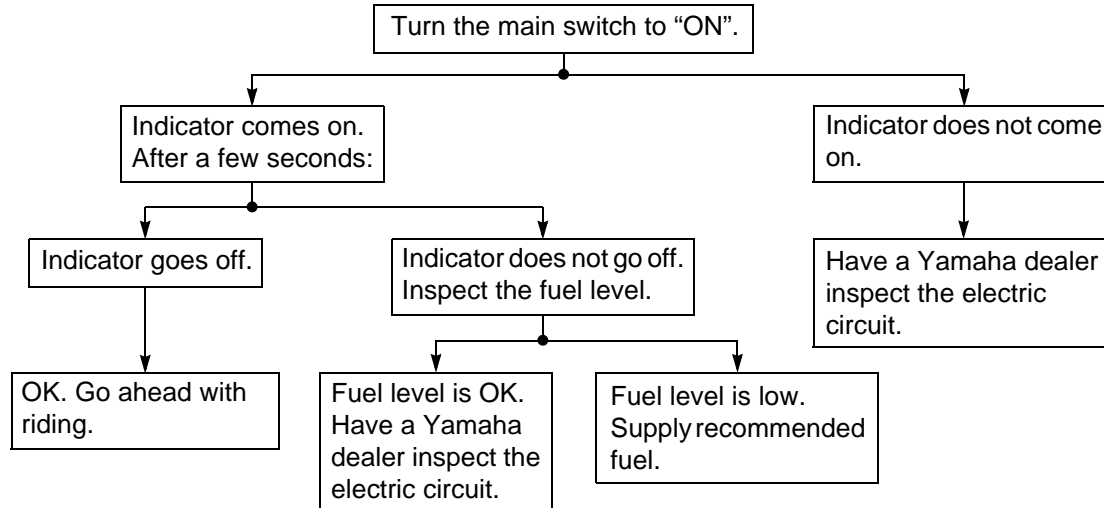

INSTRUMENT AND CONTROL FUNCTIONS

3

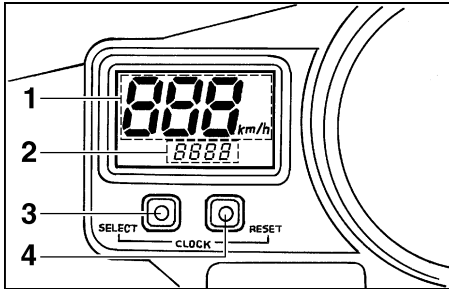

1. Speedometer
2. Clock, odometer
3. "SELECT" button
4. "RESET" button

EAU01601

Digital speedometer

This speedometer is equipped with:

- an odometer
- two trip odometers
- a fuel reserve trip meter
- a clock

NOTE: _____

For UK and USA models only:

To change the speedometer display from kilometers to miles, press the "SELECT" button for at least two seconds.

Odometer and trip meter modes

Use the trip meters to estimate how far you can ride on a tank of fuel.

Use the fuel reserve trip meter to see the distance traveled from when the fuel level dropped to the reserve level.

Selecting a mode

Push the "SELECT" button to change between the odometer mode "ODO" and the trip odometer modes "TRIP 1" and "TRIP 2" in the following order:

"ODO" → "TRIP 1" → "TRIP 2" → "ODO"

If the fuel level indicator light comes on (see page 3-2), the odometer display will automatically change to the fuel reserve trip meter mode "TRIP F" and start counting the distance traveled from that point. Push the "SELECT" button to change between the fuel odometer, trip odometer and odometer modes in the following order:

"TRIP F" → "TRIP 1" → "TRIP 2" → "ODO" → "TRIP F"

Resetting a meter

To reset a trip odometer to 0.0, select it by pushing the "SELECT" button and push the "RESET" button for at least one second. To reset the fuel reserve trip meter, select it by pushing the "SELECT" button and push the "RESET" button for at least one second. The display will return to "TRIP 1". If you do not reset the fuel reserve trip meter manually, it will automatically reset and return to "TRIP 1" after refueling and the motorcycle has traveled both 5 km and for approximately 3 minutes.

NOTE: _____

After the fuel reserve trip meter is reset, the display always returns to the "TRIP 1" mode. If "TRIP 2" was being used before the fuel reserve trip meter is reset, be sure to push the "SELECT" button to change back to the "TRIP 2" mode.

INSTRUMENT AND CONTROL FUNCTIONS

Clock mode

To change the display to the clock mode, push both the “SELECT” and “RESET” buttons.

To change the display back to the odometer mode, push the “RESET” button.

To set the clock

1. Push both the “SELECT” and “RESET” buttons for at least two seconds.
2. When the hour digits start flashing, push the “RESET” button to set the hours.
3. Push the “SELECT” button to change the minutes.
4. When the minute digits start flashing, push the “RESET” button to set the minutes.
5. Push the “SELECT” button to start the clock.

NOTE:

After setting the clock, be sure to push the “SELECT” button before turning the main switch to “OFF”, otherwise the clock will not be set.

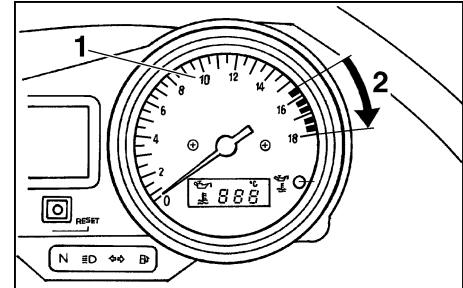

1. Tachometer
2. Red zone

EAU00101

Tachometer

This model is equipped with an electric tachometer so the rider can monitor the engine speed and keep it within the ideal power range.

EC000003

CAUTION:

**Do not operate in the red zone.
Red zone: 15,500 r/min and above**

INSTRUMENT AND CONTROL FUNCTIONS

EAU00105

Diagnosis device

This model is equipped with a self diagnosis for the following circuits:

- Throttle Position Sensor (T.P.S.) circuit
- Fuel indicator light circuit

If some trouble should occur in any of these circuits, the tachometer will repeatedly display as follows:

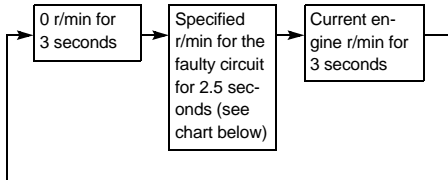

Use this chart to identify what circuit is faulty according to the specified r/min displayed.

Specified r/min	Faulty circuit
3,000 r/min	Throttle Position Sensor (T.P.S.)
8,000 r/min	Fuel indicator light

If the tachometer displays as described above, take note of the specified r/min and then take your motorcycle to a Yamaha dealer for repair.

EC000004

CAUTION:

To prevent engine damage, be sure to consult a Yamaha dealer as soon as possible if the tachometer displays a repeated change in r/min.

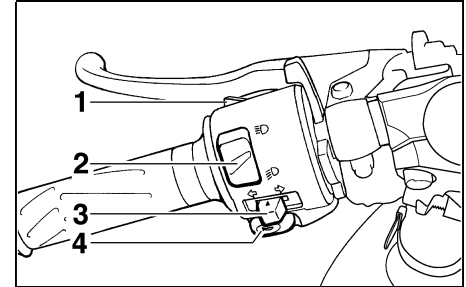

1. Pass switch "PASS"
2. Dimmer switch
3. Turn signal switch
4. Horn switch "🔔"

EAU00118

Handlebar switches

EAU00120

Pass switch "PASS"

Press the switch to operate the passing light.



EAU00121

Dimmer switch

Turn the switch to "☰☉" for the high beam and to "☷☉" for the low beam.

Turn signal switch

EAU00127

To signal a right-hand turn, push the switch to “”. To signal a left-hand turn, push the switch to “”. Once the switch is released it will return to the center position. To cancel the signal, push the switch in after it has returned to the center position.

Horn switch “”

EAU00129

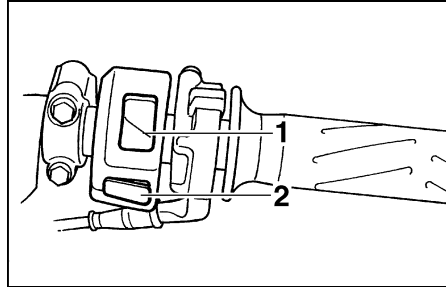

Press the switch to sound the horn.



1. Engine stop switch
2. Start switch “”

Engine stop switch

EAU00138

The engine stop switch is a safety device for use in an emergency such as when the motorcycle overturns or if trouble occurs in the throttle system. Turn the switch to “” to start the engine. In case of emergency, turn the switch to “” to stop the engine.

Start switch “”

EAU00143

The starter motor cranks the engine when pushing the start switch.

EC000005

CAUTION:

See starting instructions prior to starting the engine.

INSTRUMENT AND CONTROL FUNCTIONS

3

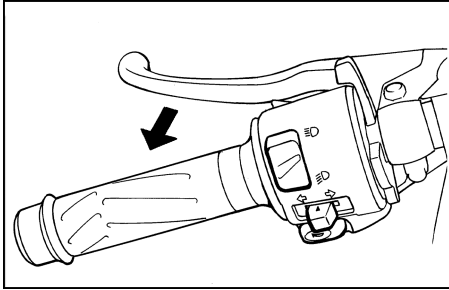

EAU00152

Clutch lever

The clutch lever is located on the left handlebar, and the ignition circuit cut-off system is incorporated in the clutch lever holder. Pull the clutch lever to the handlebar to disengage the clutch, and release the lever to engage the clutch. The lever should be pulled rapidly and released slowly for smooth clutch operation. (Refer to the engine starting procedures for a description of the ignition circuit cut-off system.)

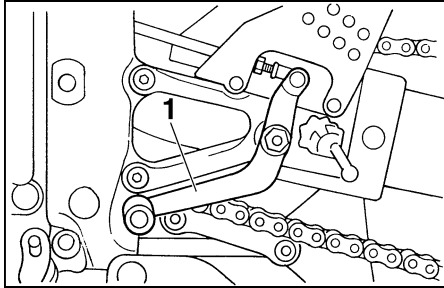

1. Shift pedal

EAU00157

Shift pedal

This motorcycle is equipped with a constant-mesh 6-speed transmission. The shift pedal is located on the left side of the engine and is used in combination with the clutch when shifting.

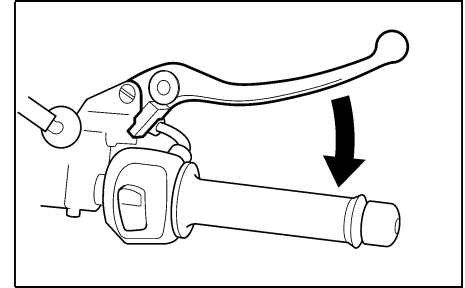

EAU00161

Front brake lever

The front brake lever is located on the right handlebar and is equipped with a brake lever adjusting dial. To activate the front brake, pull the lever toward the handlebar.

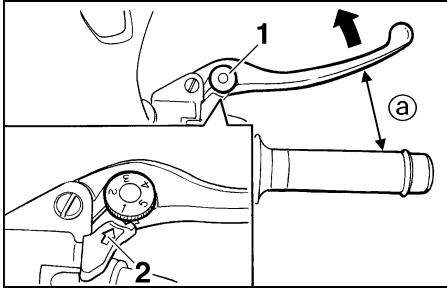

1. Lever position adjusting dial
2. Arrow mark
- a. Lever distance

To adjust the front brake lever position, turn the brake lever adjusting dial while pulling the lever forward. Make sure the setting on the brake lever adjusting dial is aligned with the arrow mark.

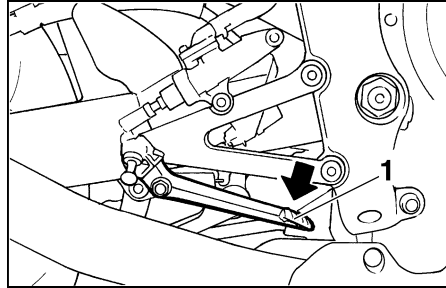

1. Rear brake pedal

EAU00162

Rear brake pedal

The rear brake pedal is on the right side of the motorcycle. Press down on the brake pedal to apply the rear brake.

INSTRUMENT AND CONTROL FUNCTIONS

3

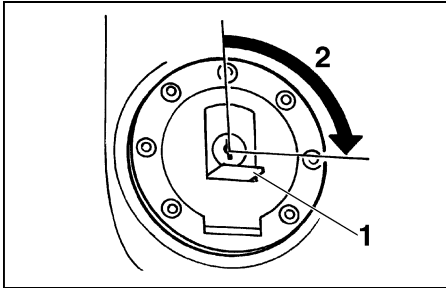

1. Lock cover
2. Open

EAU02935

Fuel tank cap

To open

Open the lock cover. Insert the key and turn it 1/4 turn clockwise. The lock will be released and the cap can be opened.

To close

Push the tank cap into position with the key inserted. To remove the key, turn it counterclockwise to the original position. Then, close the lock cover.

NOTE:

This tank cap cannot be closed unless the key is in the lock. The key cannot be removed if the cap is not locked properly.

EW000023

WARNING

Be sure the cap is properly installed and locked in place before riding the motorcycle.

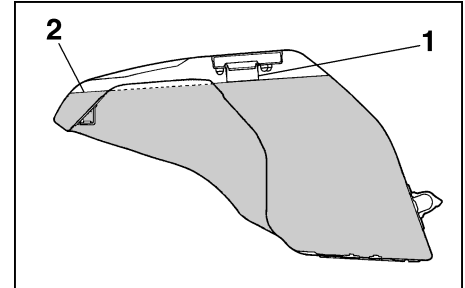

1. Filler tube
2. Fuel level

EAU01183

Fuel

Make sure there is sufficient fuel in the tank. Fill the fuel tank to the bottom of the filler tube as shown in the illustration.

EW000130

WARNING

Do not overfill the fuel tank. Avoid spilling fuel on the hot engine. Do not fill the fuel tank above the bottom of the filler tube or it may overflow when the fuel heats up later and expands.

INSTRUMENT AND CONTROL FUNCTIONS

EAU00185

CAUTION:

Always wipe off spilled fuel immediately with a dry and clean soft cloth. Fuel may deteriorate painted surfaces or plastic parts.

EAU00192

Recommended fuel:
Regular gasoline
For Australia:
Unleaded fuel only
Fuel tank capacity:
Total:
17 L
Reserve:
3.5 L

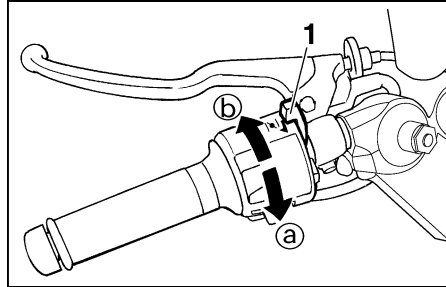

1. Starter (choke) “|↘|”

EAU02973

Starter (choke) “|↘|”

Starting a cold engine requires a richer air-fuel mixture. A separate starter circuit supplies this mixture.

Move in direction ① to turn on the starter (choke).

Move in direction ② to turn off the starter (choke).

ECA00038

CAUTION:

Do not use the starter (choke) for more than 3 minutes as the exhaust pipe may discolor from excessive heat. Also, longer use of the starter (choke) will cause afterburning. If afterburning occurs, turn off the starter (choke).

INSTRUMENT AND CONTROL FUNCTIONS

3

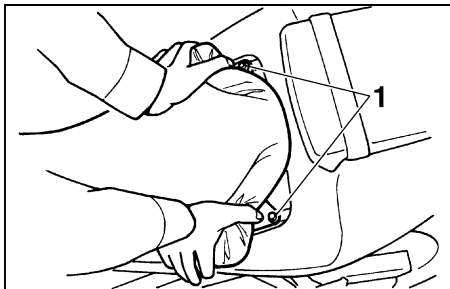

1. Bolt (× 2)

EAU01890

Seats

Rider seat

To remove

Lift up the rear corners of the seat as shown and remove the bolts.

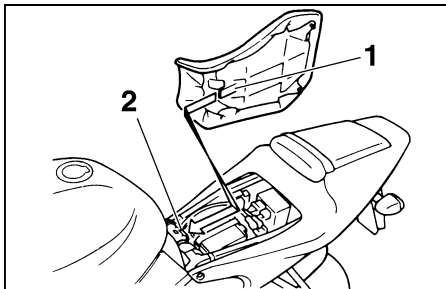

1. Projection
2. Seat holder

To install

Insert the projection on the front of the seat into the seat holder and install the bolts.

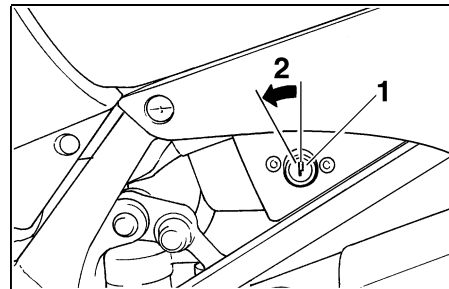

1. Passenger seat lock
2. Open

Passenger seat

To remove

Insert the key into the seat lock and turn it counterclockwise. While holding the key in that position, lift up the front of the seat and pull it forward.

INSTRUMENT AND CONTROL FUNCTIONS

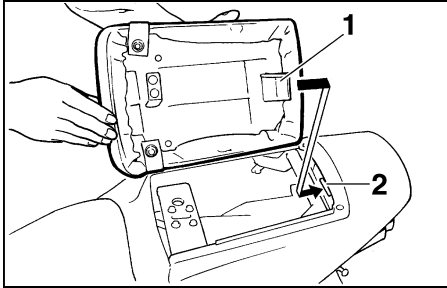

1. Projection
2. Seat holder

To install

Insert the projection on the rear of the seat into the seat holder and push down on the front of the seat.

NOTE:

Make sure that the seats are securely fitted.

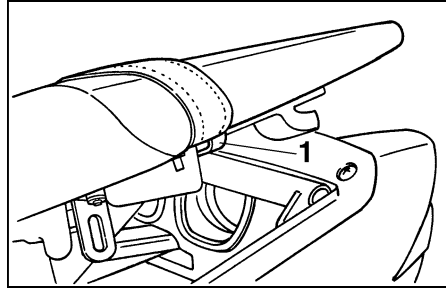

1. Helmet holder

Helmet holder

Remove the passenger seat and hook the helmet into the helmet holder. Then install the passenger seat.

EAU00265

EW000030



WARNING

Never ride with a helmet in the helmet holder. The helmet may hit objects, causing loss of control and possibly an accident.

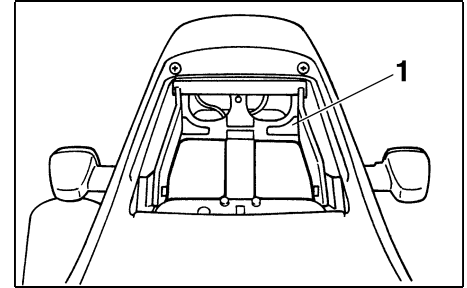

1. Storage compartment

Storage compartment

The storage compartment is located under the passenger seat. (Refer to page 3-15 for details on how to open the seat.)

EAU01242

EW000033



WARNING

Do not exceed maximum load. Maximum load: 3 kg

INSTRUMENT AND CONTROL FUNCTIONS

Front fork adjustment

EAU01862

This front fork is equipped with spring preload and damping force adjusters.

EW000037

⚠ WARNING

Each fork leg must be set to the same pressure. Uneven setting can cause poor handling and loss of stability.

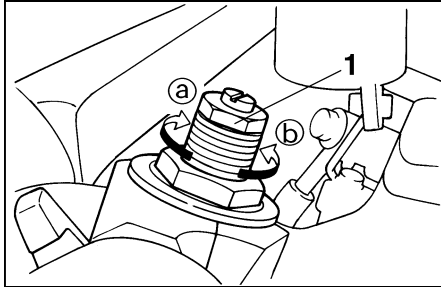

1. Spring preload adjusting bolt

Adjusting spring preload

Turn the adjusting bolt in direction ① to increase spring preload and in direction ② to decrease spring preload. Align the preferred setting with the top of the front fork cap.

EC000013

CAUTION:

The grooves are provided to show the adjustment level. Always keep the adjustment level equal on both fork legs.

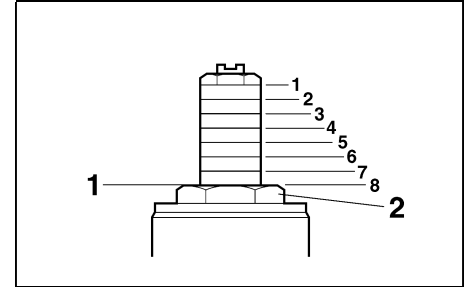

1. Setting position
2. Front fork cap bolt

	Hard							Standard	Soft
Adjusting position	1	2	3	4	5	6	7	8	

INSTRUMENT AND CONTROL FUNCTIONS

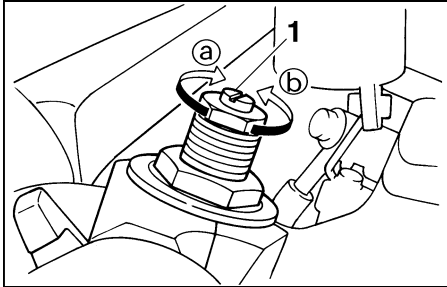

1. Rebound damping force adjusting screw

Adjusting rebound damping force

Turn adjusting screw in direction ① to increase rebound damping force and in direction ② to decrease rebound damping force.

Minimum (soft)	9 clicks out*
Standard	6 clicks out*
Maximum (hard)	1 click out*

* From the fully turned-in position

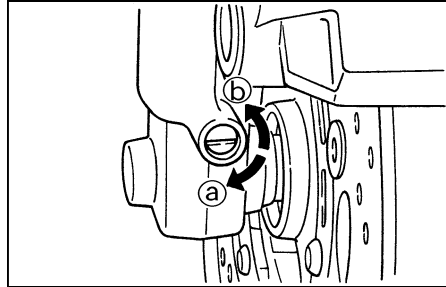

1. Compression damping force adjusting screw

Adjusting compression damping force

Turn the adjusting screw in direction ① to increase compression damping force and in direction ② to decrease compression damping force.

Minimum (soft)	10 clicks out*
Standard	6 clicks out*
Maximum (hard)	1 click out*

* From the fully turned-in position

NOTE:

Although the number of clicks between the minimum and maximum settings may vary with each individual shock absorber and may not exactly match these specifications, it is always the full damping force range that extends over the actual number of clicks.

CAUTION:

Never attempt to turn an adjuster beyond the maximum or minimum setting.

EC000015

INSTRUMENT AND CONTROL FUNCTIONS

Rear shock absorber adjustment

This shock absorber is equipped with spring preload and damping force adjusters.

EAU01863

EC000015

CAUTION:

Never attempt to turn an adjuster beyond the maximum or minimum setting.

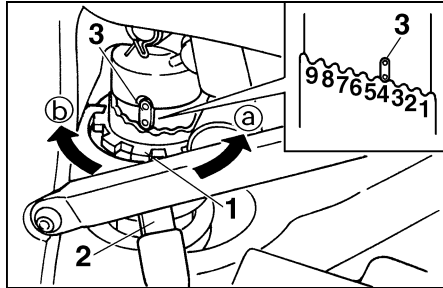

1. Spring preload adjusting ring
2. Special wrench
3. Position indicator

Adjusting spring preload

Turn the adjusting ring in direction (a) to increase spring preload and in direction (b) to decrease spring preload.

Make sure that the appropriate notch in the adjusting ring is aligned with the position indicator on the rear shock absorber.

	Hard					Standard	Soft		
Adjusting position	9	8	7	6	5	4	3	2	1

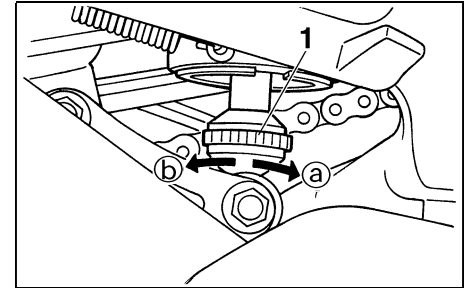

1. Rebound damping force adjusting knob

Adjusting rebound damping force

Turn the adjusting knob in direction (a) to increase rebound damping force and in direction (b) to decrease rebound damping force.

Minimum (soft)	25 clicks out*
Standard	9 clicks out*
Maximum (hard)	1 click out*

* From the fully turned-in position

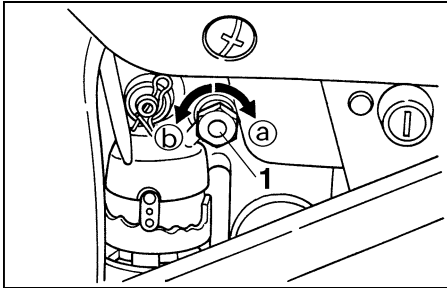

1. Compression damping force adjusting screw

Adjusting compression damping force

Turn the adjusting screw in direction **a** to increase compression damping force and in direction **b** to decrease compression damping force.

Minimum (soft)	13 clicks out*
Standard	7 clicks out*
Maximum (hard)	1 click out*

* From the fully turned-in position

NOTE: Although the number of clicks between the minimum and maximum settings may vary with each individual shock absorber and may not exactly match these specifications, it is always the full damping force range that extends over the actual number of clicks.

WARNING

This shock absorber contains highly pressurized nitrogen gas. Read and understand the following information before handling the shock absorber. The manufacturer cannot be held responsible for property damage or personal injury that may result from improper handling.

- Do not tamper with or attempt to open the cylinder assembly.
- Do not subject the shock absorber to an open flame or other high heat source. This may cause the unit to explode due to excessive gas pressure.
- Do not deform or damage the cylinder in any way. Cylinder damage will result in poor damping performance.
- Take your shock absorber to a Yamaha dealer for any service.

INSTRUMENT AND CONTROL FUNCTIONS

EAU01580

Recommended combinations of the front fork and the rear shock absorber settings

Use this table as a guide for specific settings according to motorcycle load conditions.

Loading condition	Front fork adjustment			Rear shock absorber adjustment		
	Spring preload	Compression damping force	Rebound damping force	Spring preload	Compression damping force	Rebound damping force
Solo rider	1 ~ 8	1 ~ 10	1 ~ 9	1 ~ 7	4 ~ 13	3 ~ 25
With passenger	1 ~ 8	1 ~ 10	1 ~ 9	4 ~ 9	1 ~ 8	1 ~ 7

EC000016

CAUTION:

Never attempt to turn the adjuster beyond the maximum or minimum setting.

EAU00330

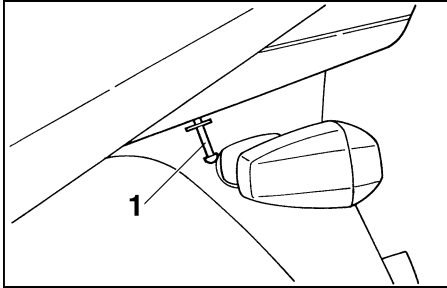

1. Luggage strap holder (× 2)

EAU01600

Luggage strap holders

There are two luggage strap holders below the rear of the passenger seat.

Sidestand

This model is equipped with an ignition circuit cut-off system. The motorcycle must not be ridden when the sidestand is down. The sidestand is located on the left side of the frame. (Refer to page 5-1 for an explanation of this system.)

EW000044

⚠ WARNING

This motorcycle must not be operated with the sidestand in the down position. If the stand is not properly retracted, it could contact the ground and distract the operator, resulting in a possible loss of control. Yamaha has designed into this motorcycle a lockout system to assist the operator in fulfilling the responsibility of retracting the sidestand. Please check carefully the operating instructions listed below and if there is any indication of a malfunction, return the motorcycle to a Yamaha dealer immediately for repair.

INSTRUMENT AND CONTROL FUNCTIONS

Sidestand/clutch switch operation check

EAU00331

Check the operation of the sidestand switch and clutch switch against the information below.

3
TURN THE MAIN SWITCH TO "ON" AND THE ENGINE STOP SWITCH TO "O".

TRANSMISSION IS IN GEAR AND SIDESTAND IS UP.

PULL IN CLUTCH LEVER AND PUSH THE START SWITCH.

ENGINE WILL START.

CLUTCH SWITCH IS OK.

SIDESTAND IS DOWN.

ENGINE WILL STALL.

SIDESTAND SWITCH IS OK.

EW000045

WARNING

If improper operation is noted, consult a Yamaha dealer immediately.

Pre-operation check list..... 4-1

PRE-OPERATION CHECKS

Owners are personally responsible for their vehicle's condition. Your motorcycle's vital functions can start to deteriorate quickly and unexpectedly, even if it remains unused (for instance, if it is exposed to the elements). Any damage, fluid leak or loss of tire pressure could have serious consequences. Therefore, it is very important that, in addition to a thorough visual inspection, you check the following points before each ride.

PRE-OPERATION CHECK LIST

ITEM	CHECKS	PAGE
Front brake	<ul style="list-style-type: none">• Check operation, free play, fluid level and fluid leakage.• Fill with DOT 4 brake fluid if necessary.	6-26 ~ 6-28
Rear brake		6-26 ~ 6-28
Clutch	<ul style="list-style-type: none">• Check operation condition and free play.• Adjust if necessary.	6-25
Throttle grip and housing	<ul style="list-style-type: none">• Check for smooth operation.• Lubricate if necessary.	6-21, 6-30
Engine oil	<ul style="list-style-type: none">• Check oil level.• Fill with oil if necessary.	6-10 ~ 6-13
Coolant reservoir tank	<ul style="list-style-type: none">• Check coolant level.• Fill with coolant if necessary.	6-13 ~ 6-16
Drive chain	<ul style="list-style-type: none">• Check chain slack and condition.• Adjust if necessary.	6-28 ~ 6-29
Wheels and tires	<ul style="list-style-type: none">• Check tire pressure, wear and damage.	6-21 ~ 6-24 6-37 ~ 6-40
Control cable	<ul style="list-style-type: none">• Check for smooth operation.• Lubricate if necessary.	6-30
Brake pedal shaft	<ul style="list-style-type: none">• Check for smooth operation.• Lubricate if necessary.	6-31
Brake and clutch lever pivots	<ul style="list-style-type: none">• Check for smooth operation.• Lubricate if necessary.	6-30

PRE-OPERATION CHECKS

ITEM	CHECKS	PAGE
Sidestand pivot	<ul style="list-style-type: none">• Check for smooth operation.• Lubricate if necessary.	6-31
Chassis fasteners	<ul style="list-style-type: none">• Make sure that all nuts, bolts and screws are properly tightened.• Tighten if necessary.	—
Fuel	<ul style="list-style-type: none">• Check fuel level.• Fill with fuel if necessary.	3-13 ~ 3-14
Lights, signals and switches	<ul style="list-style-type: none">• Check for proper operation.	6-35 ~ 6-37

NOTE: _____
Pre-operation checks should be made each time the motorcycle is used. Such an inspection can be thoroughly accomplished in a very short time; and the added safety it assures is more than worth the time involved.

 **WARNING**

If any item in the PRE-OPERATION CHECK is not working properly, have it inspected and repaired before operating the motorcycle.

OPERATION AND IMPORTANT RIDING POINTS

Starting and warming up a cold engine.....	5-1
Starting a warm engine	5-3
Shifting	5-4
Tips for reducing fuel consumption	5-4
Engine break-in	5-5
Parking	5-5

EAU00373

EAU01383

! WARNING

- Before riding this motorcycle, become thoroughly familiar with all operating controls and their functions. Consult a Yamaha dealer regarding any control or function that you do not thoroughly understand.
- Never start your engine or let it run for any length of time in a closed area. The exhaust fumes are poisonous and can cause loss of consciousness and death within a short time. Always operate your motorcycle in an area with adequate ventilation.
- Before starting out, always be sure the sidestand is up. Failure to retract the sidestand completely can result in a serious accident when you try to turn a corner.

Starting and warming up a cold engine

NOTE:

This motorcycle is equipped with an ignition circuit cut-off system.

The engine can be started only under one of the following conditions:

- The transmission is in neutral.
- The sidestand is up, the transmission is in gear and the clutch is disengaged.

The motorcycle must not be ridden when the sidestand is down.

EW000054

! WARNING

Before going through the following steps, check the function of the sidestand switch and clutch switch. (Refer to page 3-23.)

OPERATION AND IMPORTANT RIDING POINTS

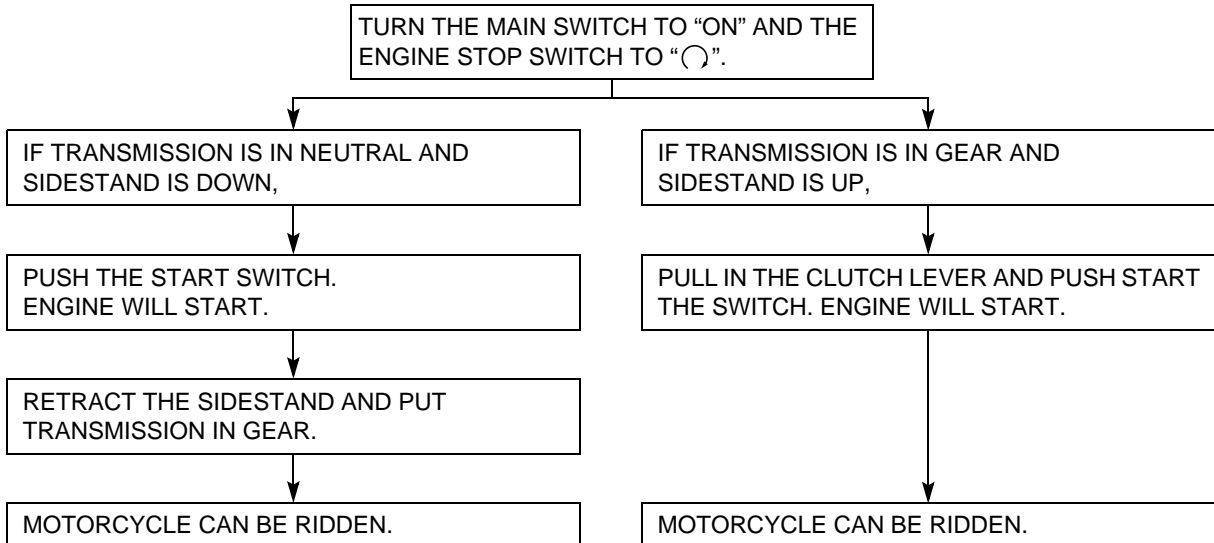

OPERATION AND IMPORTANT RIDING POINTS

1. Turn the main switch to “ON” and the engine stop switch to “○”.

ECA00005

CAUTION:

The oil level/coolant temperature indicator light and fuel indicator light should come on for a few seconds and then go off. If an indicator light does not go off, refer to the corresponding indicator light circuit check in the “INSTRUMENT AND CONTROL FUNCTIONS” section.

2. Shift the transmission into neutral.

NOTE:

When the transmission is in neutral, the neutral indicator light should be on. If the light does not come on, ask a Yamaha dealer to inspect it.

3. Turn on the starter (choke) and completely close the throttle grip.
4. Start the engine by pushing the start switch.

NOTE:

If the engine fails to start, release the start switch, wait a few seconds, then try again. Each attempt should be as short as possible to preserve the battery. Do not crank the engine more than 10 seconds on any one attempt.

5. After starting the engine, move the starter (choke) to the warming up position.

NOTE:

For maximum engine life, always warm up the engine before starting off. Never accelerate hard with a cold engine.

6. After warming up the engine, turn off the starter (choke) completely.

NOTE:

The engine is warm when it responds normally to the throttle with the starter (choke) turned off.

EAU01258

Starting a warm engine

The starter (choke) is not required when the engine is warm.

EC000046

CAUTION:

See the “Engine break-in” section prior to operating the motorcycle for the first time.

EC000048

EAU00424

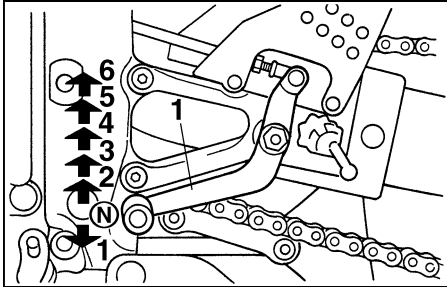

1. Shift pedal
N. Neutral

EAU00423

Shifting

The transmission lets you control the amount of power you have available at a given speed for starting, accelerating, climbing hills, etc. The use of the shift pedal is shown in the illustration.

To shift into neutral, depress the shift pedal repeatedly until it reaches the end of its travel, then raise the pedal slightly.

CAUTION:

- Do not coast for long periods with the engine off, and do not tow the motorcycle a long distance. Even with gears in neutral, the transmission is only properly lubricated when the engine is running. Inadequate lubrication may damage the transmission.
- Always use the clutch when changing gears. The engine, transmission, and driveline are not designed to withstand the shock of forced shifting and can be damaged by shifting without using the clutch.

Tips for reducing fuel consumption

Your motorcycle's fuel consumption depends to a large extent on your riding style. The following tips can help reduce fuel consumption:

- Warm up the engine before riding.
- Turn off the starter (choke) as soon as possible.
- Shift up swiftly and avoid high engine speeds during acceleration.
- Do not double-clutch or rev the engine while shifting down and avoid high engine speeds with no load on the engine.
- Turn off the engine instead of letting it idle for an extended length of time, i.e. in traffic jams, at traffic lights or railroad crossings.

OPERATION AND IMPORTANT RIDING POINTS

Engine break-in

EAU01128

There is never a more important period in the life of your motorcycle than the period between zero and 1,600 km. For this reason we ask that you carefully read the following material. Because the engine is brand new, you must not put an excessive load on it for the first 1,600 km. The various parts in the engine wear and polish themselves to the correct operating clearances. During this period, prolonged full throttle operation, or any condition which might result in excessive heating of the engine, must be avoided.

0 ~ 1,000 km

Avoid operation above 5,000 r/min.

EAU01329

1,000 ~ 1,600 km

Avoid cruising speeds in excess of 6,000 r/min.

EC000052

CAUTION: _____

After 1,000 km of operation, be sure to replace the engine oil and oil filter.

1,600 km and beyond

Proceed with normal riding.

EC000053

CAUTION: _____

- Never let engine speeds enter the red zone.
 - If any engine trouble should occur during the break-in period, consult a Yamaha dealer immediately.
-

Parking

EAU00460

When parking the motorcycle, stop the engine and remove the ignition key.

EW000058

⚠ WARNING _____

The exhaust system is hot. Park the motorcycle in a place where pedestrians or children are not likely to touch the motorcycle. Do not park the motorcycle on a slope or soft ground; the motorcycle may overturn.

PERIODIC MAINTENANCE AND MINOR REPAIR

Tool kit.....	6-1	Drive chain slack adjustment	6-29
Periodic maintenance and lubrication.....	6-3	Drive chain lubrication.....	6-29
Cowling and panel removal and installation.....	6-6	Cable inspection and lubrication	6-30
Cowlings A and B	6-6	Throttle cable and grip lubrication	6-30
Panel C	6-8	Brake and clutch lever lubrication	6-30
Spark plug inspection	6-9	Brake pedal lubrication.....	6-31
Engine oil	6-10	Sidestand lubrication.....	6-31
Cooling system	6-13	Rear suspension lubrication.....	6-31
Changing the coolant.....	6-14	Front fork inspection.....	6-32
Air filter	6-17	Steering inspection	6-32
Air intake duct.....	6-19	Wheel bearings	6-33
Carburetor adjustment	6-20	Battery.....	6-33
Idle speed adjustment	6-20	Fuse replacement	6-34
Throttle cable free play inspection	6-21	Headlight bulb replacement	6-35
Valve clearance adjustment.....	6-21	Taillight bulb replacement.....	6-36
Tires.....	6-21	Turn signal light bulb replacement.....	6-37
Wheels.....	6-24	Supporting the motorcycle	6-37
Clutch lever free play adjustment.....	6-25	Front wheel removal.....	6-38
Brake light switch adjustment	6-25	Front wheel installation	6-38
Checking the front and rear brake pads.....	6-26	Rear wheel removal	6-39
Inspecting the brake fluid level.....	6-27	Rear wheel installation	6-40
Brake fluid replacement	6-28	Troubleshooting	6-40
Drive chain slack check	6-28	Troubleshooting chart.....	6-41

Periodic inspection, adjustment and lubrication will keep your motorcycle in the safest and most efficient condition possible. Safety is an obligation of the motorcycle owner. The maintenance and lubrication schedule chart should be considered strictly as a guide to general maintenance and lubrication intervals. YOU MUST TAKE INTO CONSIDERATION THAT WEATHER, TERRAIN, GEOGRAPHICAL LOCATIONS, AND A VARIETY OF INDIVIDUAL USES ALL TEND TO DEMAND THAT EACH OWNER ALTER THIS TIME SCHEDULE TO SHORTER INTERVALS TO MATCH THE ENVIRONMENT. The most important points of motorcycle inspection, adjustment, and lubrication are explained in the following pages.

EAU00464

EAU01296

CAUTION:

Do not test this motorcycle on a dynamometer for an extended period of time as discoloration to the fiber constructed muffler may occur from the heat.

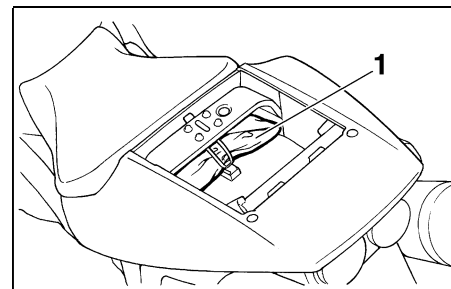

1. Tool kit

EAU01575

Tool kit

The tool kit is located inside the storage compartment under the passenger seat. (See page 3-15 for seat opening procedures.) The tools provided in the owner's tool kit are to assist you in the performance of periodic maintenance. However, some other tools such as a torque wrench are also necessary to perform the maintenance correctly.

The service information included in this manual is intended to provide you, the owner, with the necessary information for completing some of your own preventive maintenance and minor repairs.

⚠ WARNING

If you are not familiar with motorcycle service, this work should be done by a Yamaha dealer.

EW000060

PERIODIC MAINTENANCE AND MINOR REPAIR

NOTE:

If you do not have necessary tools required during a service operation, take your motorcycle to a Yamaha dealer for service.

EW000063

WARNING

Modifications to this motorcycle not approved by Yamaha may cause loss of performance, and render it unsafe for use. Consult a Yamaha dealer before attempting any changes.

PERIODIC MAINTENANCE AND MINOR REPAIR

EAU00473

PERIODIC MAINTENANCE AND LUBRICATION

NO.	ITEM	CHECKS AND MAINTENANCE JOBS	INITIAL (1,000 km)	EVERY	
				6,000 km or 6 months (whichever comes first)	12,000 km or 12 months (whichever comes first)
1	* Fuel line	<ul style="list-style-type: none"> • Check fuel hoses and vacuum hose for cracks or damage. • Replace if necessary. 		√	√
2	* Fuel filter	<ul style="list-style-type: none"> • Check condition. • Replace if necessary. 			√
3	Spark plugs	<ul style="list-style-type: none"> • Check condition. • Clean, regap or replace if necessary. 	√	√	√
4	* Valves	<ul style="list-style-type: none"> • Check valve clearance. • Adjust if necessary. 	Every 42,000 km or 42 months (whichever comes first)		
5	Air filter	<ul style="list-style-type: none"> • Clean or replace if necessary. 		√	√
6	Clutch	<ul style="list-style-type: none"> • Check operation. • Adjust or replace cable. 	√	√	√
7	* Front brake	<ul style="list-style-type: none"> • Check operation, fluid level and vehicle for fluid leakage. (See NOTE on page 6-5.) • Correct accordingly. • Replace brake pads if necessary. 	√	√	√
8	* Rear brake	<ul style="list-style-type: none"> • Check operation, fluid level and vehicle for fluid leakage. (See NOTE on page 6-5.) • Correct accordingly. • Replace brake pads if necessary. 	√	√	√
9	* Wheels	<ul style="list-style-type: none"> • Check balance, runout and for damage. • Rebalance or replace if necessary. 		√	√
10	* Tires	<ul style="list-style-type: none"> • Check tread depth and for damage. • Replace if necessary. • Check air pressure. • Correct if necessary. 		√	√

6

PERIODIC MAINTENANCE AND MINOR REPAIR

NO.	ITEM	CHECKS AND MAINTENANCE JOBS	INITIAL (1,000 km)	EVERY	
				6,000 km or 6 months (whichever comes first)	12,000 km or 12 months (whichever comes first)
11	* Wheel bearings	<ul style="list-style-type: none"> • Check bearing for looseness or damage. • Replace if necessary. 		√	√
12	* Swingarm	<ul style="list-style-type: none"> • Check swingarm pivoting point for play. • Correct if necessary. • Lubricate with lithium soap base grease every 24,000 km or 24 months (whichever comes first). 		√	√
13	Drive chain	<ul style="list-style-type: none"> • Check chain slack. • Adjust if necessary. Make sure that the rear wheel is properly aligned. • Clean and lubricate. 	Every 1,000 km and after washing the motorcycle or riding in the rain		
14	* Steering bearings	<ul style="list-style-type: none"> • Check bearing play and steering for roughness. • Correct accordingly. • Lubricate with lithium soap base grease every 24,000 km or 24 months (whichever comes first). 		√	√
15	* Chassis fasteners	<ul style="list-style-type: none"> • Make sure that all nuts, bolts and screws are properly tightened. • Tighten if necessary. 		√	√
16	Sidestand	<ul style="list-style-type: none"> • Check operation. • Lubricate and repair if necessary. 		√	√
17	* Sidestand switch	<ul style="list-style-type: none"> • Check operation. • Replace if necessary. 	√	√	√
18	* Front fork	<ul style="list-style-type: none"> • Check operation and for oil leakage. • Correct accordingly. 		√	√
19	* Rear shock absorber assembly	<ul style="list-style-type: none"> • Check operation and shock absorber for oil leakage. • Replace shock absorber assembly if necessary. 		√	√
20	* Rear suspension relay arm and connecting arm pivoting points	<ul style="list-style-type: none"> • Check operation. • Correct if necessary. 		√	√
21	* Carburetors	<ul style="list-style-type: none"> • Check engine idling speed, synchronization and starter operation. • Adjust if necessary. 	√	√	√

PERIODIC MAINTENANCE AND MINOR REPAIR

NO.	ITEM	CHECKS AND MAINTENANCE JOBS	INITIAL (1,000 km)	EVERY	
				6,000 km or 6 months (whichever comes first)	12,000 km or 12 months (whichever comes first)
22	Engine oil	<ul style="list-style-type: none"> • Check oil level and vehicle for oil leakage. • Correct if necessary. • Change. (Warm engine before draining.) 	√	√	√
23	Engine oil filter cartridge	<ul style="list-style-type: none"> • Replace. 	√		√
24 *	Cooling system	<ul style="list-style-type: none"> • Check coolant level and vehicle for coolant leakage. • Correct if necessary. • Change coolant every 24,000 km or 24 months (whichever comes first). 		√	√

* Since these items require special tools, data and technical skills, they should be serviced by a Yamaha dealer.

EAU02970*

NOTE:

- The air filter needs more frequent service if you are riding in unusually wet or dusty areas.
- Hydraulic brake system
 - When disassembling the master cylinder or caliper cylinder, always replace the brake fluid. Check the brake fluid level regularly and fill as required.
 - Replace the oil seals on the inner parts of the master cylinder and caliper cylinder every two years.
 - Replace the brake hoses every four years or if cracked or damaged.

PERIODIC MAINTENANCE AND MINOR REPAIR

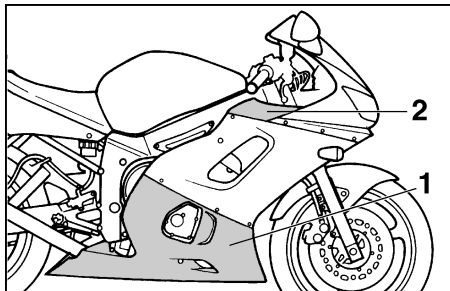

1. Cowling A (right side)
Cowling B (left side)
2. Panel C

EAU01139

Cowling and panel removal and installation

The cowlings and panels illustrated need to be removed to perform some of the maintenance described in this chapter. Refer to this section each time a cowling or panel has to be removed or reinstalled.

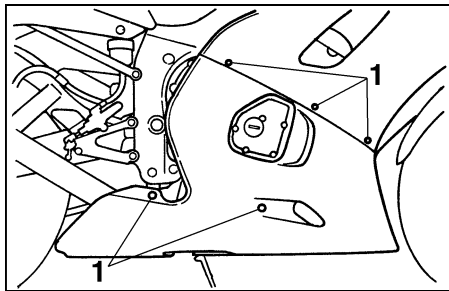

1. Screw (× 5)

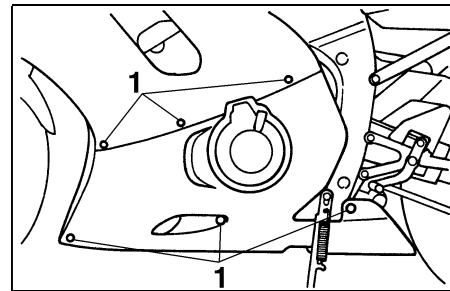

1. Screw (× 6)

EAU01602

Cowlings A and B

To remove

1. Remove the screws.

PERIODIC MAINTENANCE AND MINOR REPAIR

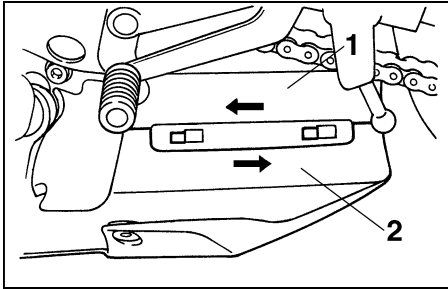

1. Cowling A
2. Cowling B

2. Disengage the cowling by sliding it forward (for A) or backward (for B), then pulling it outward.

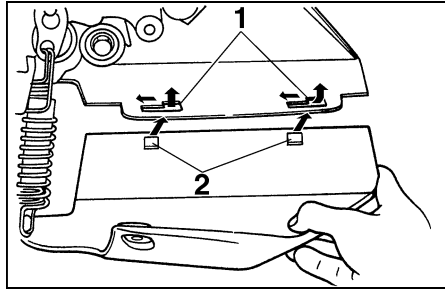

1. Slot (× 2)
2. Projection (× 2)

To install

1. Fit the slots and projections at the rear bottom of the cowlings together and slide the cowling into place.

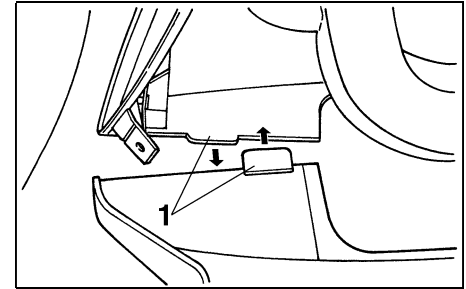

1. Tab (× 2)

2. Place the cowling in its original position. Make sure that the tabs at the front of the cowlings fit side by side as shown and that all slots and projections fit together.
3. Install the screws.

PERIODIC MAINTENANCE AND MINOR REPAIR

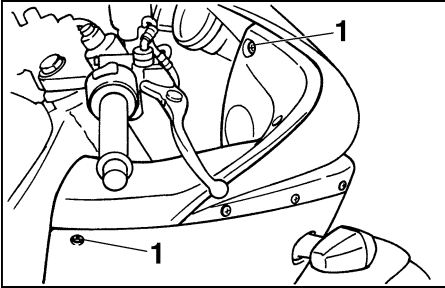

1. Screw (x 2)

EAU01315

Panel C

To remove

Remove the screws.

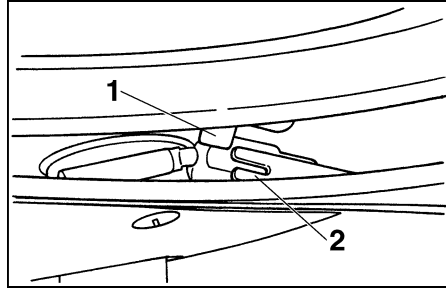

1. Projection

2. Slot

To install

Place the panel in the original position and install the screws.

PERIODIC MAINTENANCE AND MINOR REPAIR

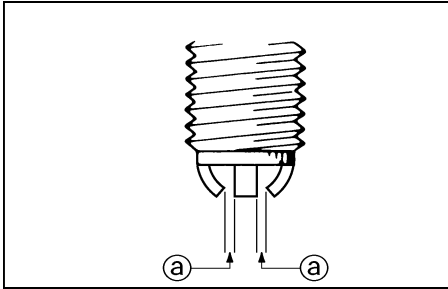

a. Spark plug gap

EAU01639

Spark plug inspection

The spark plug is an important engine component and should be inspected periodically, preferably by a Yamaha dealer. The condition of the spark plug can indicate the condition of the engine.

Normally, all spark plugs from the same engine should have the same color on the white insulator around the center electrode. The ideal color at this point is a medium-to-light tan color for a motorcycle that is being ridden normally. If one spark plug shows a distinctly different color, there could be something wrong with the engine.

Do not attempt to diagnose such problems yourself. Instead, take the motorcycle to a Yamaha dealer. The spark plugs should be periodically removed and inspected because heat and deposits will cause any spark plug to slowly break down and erode. If electrode erosion becomes excessive, or if carbon and other deposits are excessive, the spark plug should be replaced with the specified plug.

Specified spark plug:
CR10EK (NGK)

Before installing any spark plug, measure the electrode gap with a wire thickness gauge and adjust it to specification.

Spark plug gap:
0.6 ~ 0.7 mm

When installing a spark plug, the gasket surface should always be cleaned and a new gasket used. Any grime should be wiped off from the threads and the spark plug tightened to the specified torque.

Tightening torque:
Spark plug:
12.5 Nm (1.25 m·kg)

NOTE: _____
If a torque wrench is not available when installing a spark plug, a good estimate of the correct torque is 1/4 to 1/2 turn past finger tight. The spark plug should be tightened to the specified torque as soon as possible.

ECA00021

CAUTION:

Do not use any type of tools to remove or install the cap as the ignition coil coupler may get damaged. The spark plug cap may be difficult to remove because a rubber seal on the end of the cap is tightly fit into the cylinder bore. To remove the cap, simply twist it back and forth while pulling it upward; when installing the cap, twist it back and forth while pushing it downward.

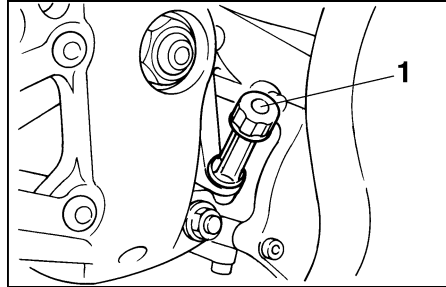

1. Dipstick

EAU01610

Engine oil

Oil level inspection

1. Place the motorcycle on a level place and hold it in an upright position. Warm up the engine for several minutes.

NOTE:

Be sure the motorcycle is positioned straight up when checking the oil level. A slight tilt toward the side can result in false readings.

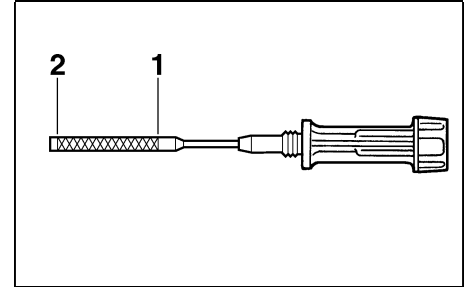

1. Maximum level mark

2. Minimum level mark

2. Stop the engine and remove the dipstick.

NOTE:

Wait a few minutes until the oil level settles before checking.

3. The oil level should be between maximum and minimum marks. If the level is low, fill the engine with sufficient oil to reach the specified level.

PERIODIC MAINTENANCE AND MINOR REPAIR

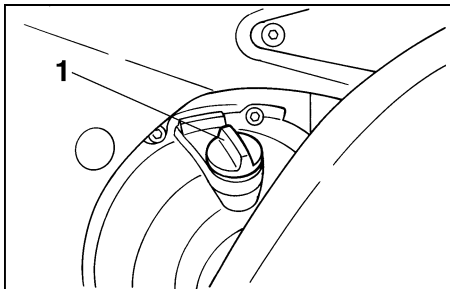

1. Engine oil filler cap

Engine oil and oil filter cartridge replacement

1. Remove cowling B. (See page 6-6 for removal and installation procedures.)
2. Warm up the engine for several minutes.
3. Stop the engine. Place an oil pan under the engine and remove the dipstick.

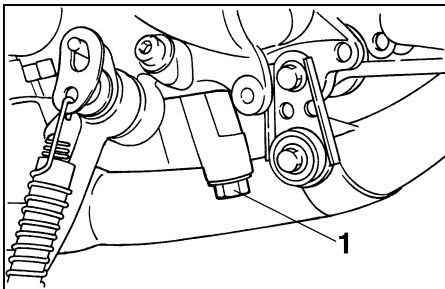

1. Engine oil drain plug

4. Remove the drain plug and drain the oil.
5. Remove the oil filter by using an oil filter wrench.

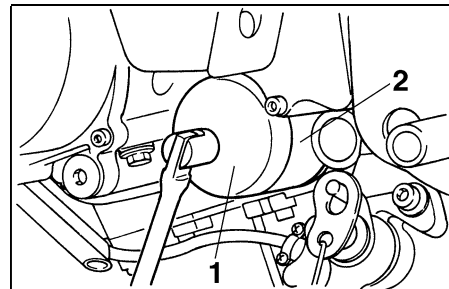

1. Oil filter wrench
2. Oil filter cartridge

NOTE: _____
An oil filter wrench is available at a nearby Yamaha dealer.

6. Reinstall the drain plug and tighten it to the specified torque.

Tightening torque:
Drain plug:
43 Nm (4.3 m·kg)

PERIODIC MAINTENANCE AND MINOR REPAIR

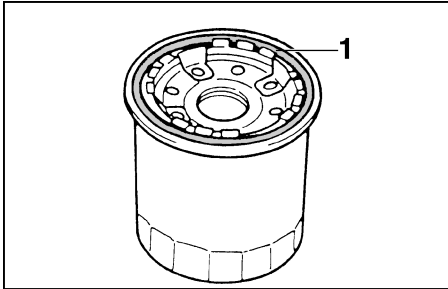

1. O-ring

7. Apply a light coat of engine oil to the O-ring of the new oil filter.

NOTE: _____
Make sure the O-ring is seated properly.

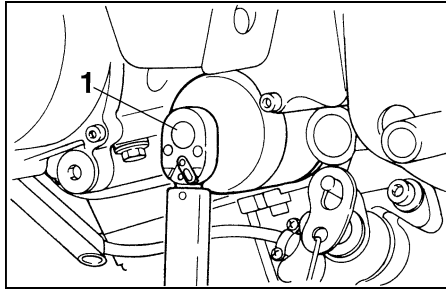

1. Torque wrench

8. Install the oil filter and tighten it to the specified torque with an oil filter wrench.

Tightening torque:
Oil filter:
17 Nm (1.7 m·kg)

9. Fill the engine with sufficient oil to reach the specified level. Install the dipstick and tighten it.

Recommended oil:

See page 8-1.

Oil quantity:

Total amount:

3.5 L

Periodic oil change:

2.5 L

With oil filter replacement:

2.7 L

EC000066

CAUTION:

- Do not put in any chemical additives. Engine oil also lubricates the clutch and additives could cause clutch slippage.
- Be sure no foreign material enters the crankcase.

PERIODIC MAINTENANCE AND MINOR REPAIR

10. Start the engine and warm it up for several minutes. While warming up, check for oil leakage. If oil leakage is found, stop the engine immediately and check for the cause.
11. After the engine is started, the oil level indicator light should go off if the oil is at the specified level.

EC000067

CAUTION:

If the indicator light flickers or remains on, immediately stop the engine and consult with a Yamaha dealer.

12. Install the cowling.

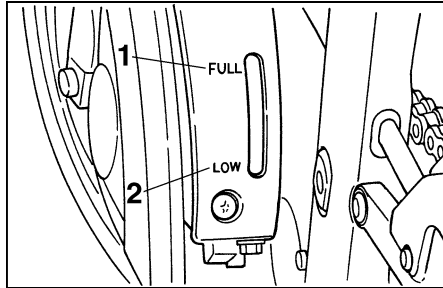

1. Maximum level mark
2. Minimum level mark

EAU01611

Cooling system

1. Check the coolant level in the reservoir tank when the engine is cold as the coolant level will vary with engine temperature. The coolant level should be between the maximum and minimum marks.

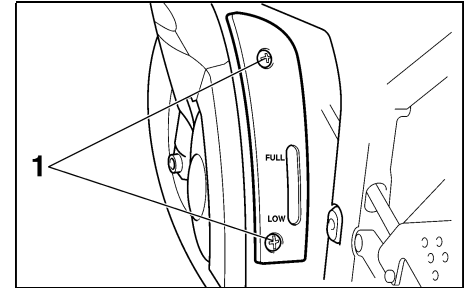

1. Bolt (× 2)

2. If the level is low, remove the reservoir tank cover by removing the bolts.
3. Add coolant or distilled water to raise it to the specified level.
4. Install the reservoir tank cover and bolts.

Reservoir tank capacity:
0.44 L

PERIODIC MAINTENANCE AND MINOR REPAIR

EC000080

CAUTION:

Hard water or salt water is harmful to the engine. You may use distilled water if you can't get soft water.

NOTE:

If water is added, have a Yamaha dealer check the antifreeze content of the coolant as soon as possible.

The radiator fan operation is completely automatic. It is switched on or off according to the coolant temperature in the radiator.

5. If your motorcycle overheats, see page 6-42 for details.

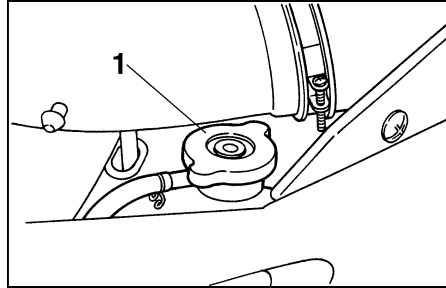

1. Radiator cap

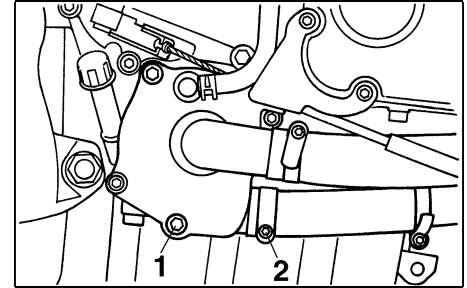

1. Water pump drain bolt
2. Clamp bolt

Changing the coolant

1. Remove panel C, cowling A and cowling B. (See page 6-6 for removal and installation procedures.)
2. Place a container under the engine.
3. Remove the radiator cap.

4. Remove the water pump drain bolt and drain the coolant from the water pump housing.
5. Disconnect the radiator hose by loosening the clamp and drain the coolant completely.
6. Thoroughly flush the cooling system with clean tap water.

EAU01612

PERIODIC MAINTENANCE AND MINOR REPAIR

7. Connect the radiator hose and tighten the clamp.
8. Retighten the drain bolt to the specified torque. If the gasket is damaged, replace it.

Tightening torque:

Drain bolt:

12 Nm (1.2 m·kg)

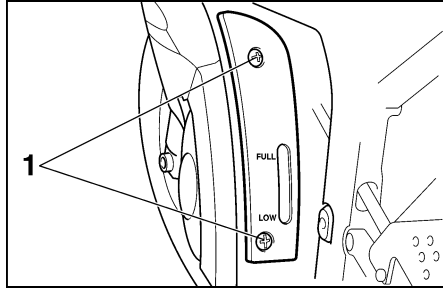

1. Bolt (× 2)

9. Remove the reservoir tank cover by removing the bolts.

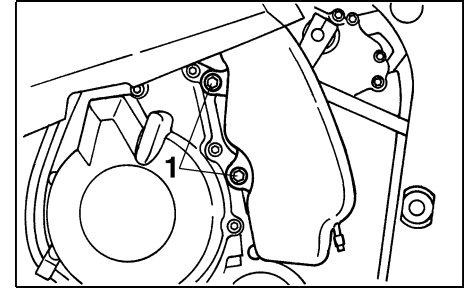

1. Bolt (× 2)

10. Remove the reservoir tank by removing the bolts.
11. Remove the reservoir tank cap and turn the tank upside down to empty it.
12. Install the reservoir tank.
13. Fill the reservoir tank with coolant up to the maximum level, then install the cap and cover.
14. Pour the recommended coolant into the radiator until it is full.

PERIODIC MAINTENANCE AND MINOR REPAIR

Recommended anti-freeze:

High quality ethylene glycol anti-freeze containing corrosion inhibitors for aluminum engines.

Antifreeze and water mix ratio:

1:1

Total amount:

2.15 L

Reservoir tank capacity:

0.44 L

EC000080

CAUTION: _____

Hard water or salt water is harmful to the engine. You may use distilled water if you can't get soft water.

15. Install the radiator cap.
16. Run the engine several minutes to recheck the coolant level in the radiator. If it is low, fill with more coolant until it reaches the top of the radiator.

17. Check for coolant leakage.

NOTE: _____
If you find any leaks, ask a Yamaha dealer to inspect.

18. Install the panel and the cowling.

PERIODIC MAINTENANCE AND MINOR REPAIR

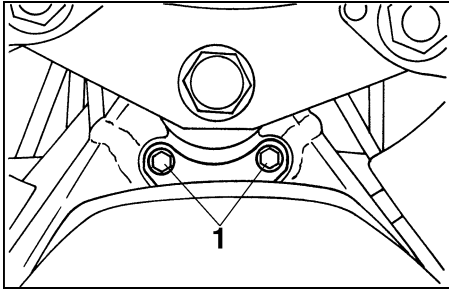

1. Bolt (× 2)

EAU01821

Air filter

The air filter should be cleaned at the specified intervals. It should be cleaned more frequently if you are riding in unusually wet or dusty areas.

1. Remove the rider seat. (See page 3-15 for seat removal and installation procedures.)
2. Remove the bolts holding the fuel tank.
3. Lift the fuel tank upward.

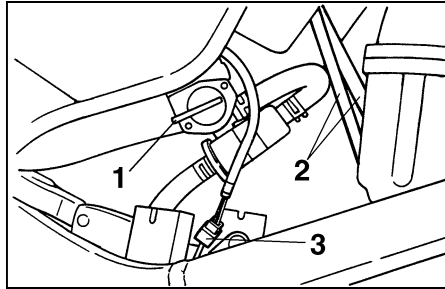

1. Fuel cock
2. Hose (× 2)
3. Fuel sender lead coupler

4. Set the fuel cock to “OFF”.
5. Disconnect the fuel sender lead coupler.
6. Disconnect the hoses.

NOTE: _____
Before removing the hoses, mark them to ensure that they will be reinstalled in their correct positions.

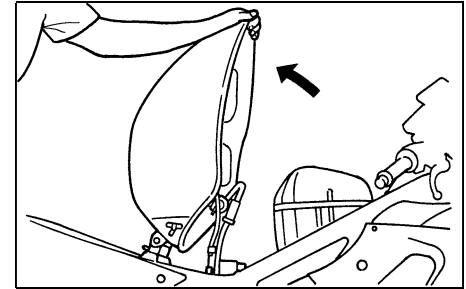

7. Tilt the front of the fuel tank back away from the air filter case. Be sure to support it as shown.

PERIODIC MAINTENANCE AND MINOR REPAIR

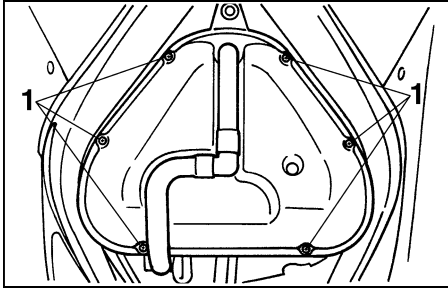

1. Screw (× 6)

8. Remove the screws holding the air filter case cover.

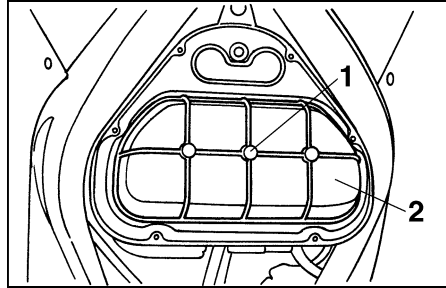

1. Air filter frame

2. Air filter

9. Remove the air filter frame and the air filter.

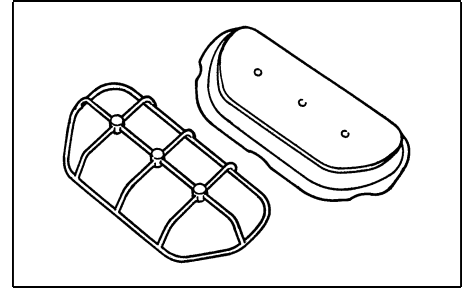

10. Clean the air filter with solvent. After cleaning, squeeze the air filter to remove the remaining solvent.

11. Apply recommended oil to the entire surface of the filter and squeeze out the excess oil. The air filter should be wet but not dripping.

Recommended oil:
Engine oil

PERIODIC MAINTENANCE AND MINOR REPAIR

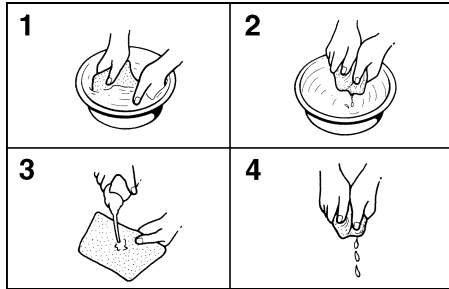

EC000082

CAUTION:

- Make sure the air filter is properly seated in the air filter case.
- The engine should never be run without the air filter installed. Excessive piston and/or cylinder wear may result.

12. Reverse the removal procedure for installation.

EW000131

⚠ WARNING

Make sure that the fuel hoses and vacuum hose are properly connected, in place and not pinched. If a hose is damaged, be sure to replace it.

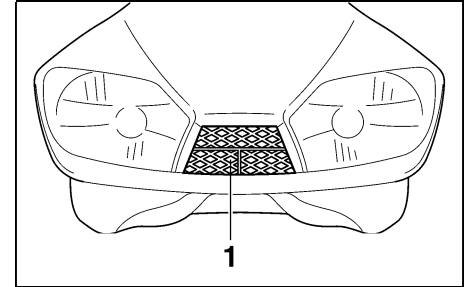

1. Air intake duct

EAU01335

Air intake duct

Check that the screen of the intake duct is not blocked. Clean the screen if necessary.

Carburetor adjustment

EAU00630

The carburetors are important parts of the engine and require very sophisticated adjustment. Most adjustments should be left to a Yamaha dealer who has the professional knowledge and experience to do so. However, the idle speed may be adjusted by the owner as part of routine maintenance.

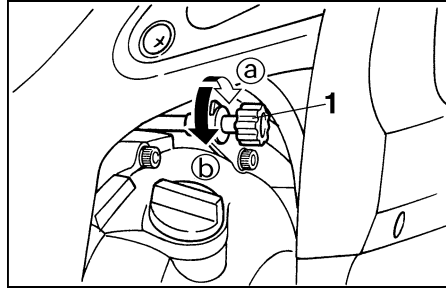

1. Throttle stop screw

Standard idle speed:
1,250 ~ 1,350 r/min

NOTE: _____
If the specified idle speed cannot be obtained by performing the above adjustment, consult a Yamaha dealer.

EAU00632

CAUTION: _____

The carburetors were set at the Yamaha factory after many tests. If they are changed, poor engine performance and damage may result.

Idle speed adjustment

1. Start the engine and warm it up for a few minutes at approximately 1,000 to 2,000 r/min. Occasionally rev the engine to 4,000 to 5,000 r/min. The engine is warm when it quickly responds to the throttle.
2. Set the idle to the specified engine speed by adjusting the throttle stop screw. Turn the screw in direction ① to increase engine speed and in direction ② to decrease engine speed.

PERIODIC MAINTENANCE AND MINOR REPAIR

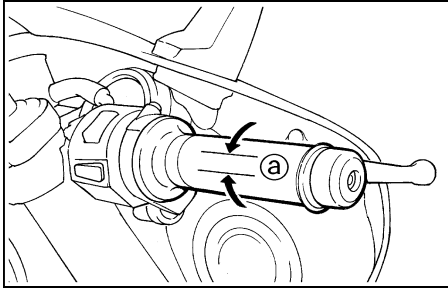

a. Free play

EAU00635

Throttle cable free play inspection

There should be a free play of 6 ~ 8 mm at the throttle grip. If the free play is incorrect, ask a Yamaha dealer to make this adjustment.

6

EAU00637

Valve clearance adjustment

The correct valve clearance changes with use, resulting in improper fuel/air supply or engine noise. To prevent this, the valve clearance must be adjusted regularly. This adjustment however, should be left to a professional Yamaha service technician.

EAU01132

Tires

To ensure maximum performance, long service and safe operation, note the following:

Tire air pressure

Always check and adjust the tire pressure before operating the motorcycle.

EW000082

⚠ WARNING

Tire inflation pressure should be checked and adjusted when the temperature of the tire equals the ambient air temperature. Tire inflation pressure must be adjusted according to total weight of cargo, rider, passenger, and accessories (fairing, saddlebags, etc. if approved for this model), and vehicle speed.

PERIODIC MAINTENANCE AND MINOR REPAIR

Maximum load*	187 kg	
Cold tire pressure	Front	Rear
Up to 90 kg load*	250 kPa (2.50 kgf/cm ² , 2.50 bar)	250 kPa (2.50 kgf/cm ² , 2.50 bar)
90 kg load ~ Maximum load*	250 kPa (2.50 kgf/cm ² , 2.50 bar)	290 kPa (2.90 kgf/cm ² , 2.90 bar)
High speed riding	250 kPa (2.50 kgf/cm ² , 2.50 bar)	250 kPa (2.50 kgf/cm ² , 2.50 bar)

* Load is the total weight of cargo, rider, passenger and accessories.

EW000083

⚠ WARNING

Proper loading of your motorcycle is important for several characteristics of your motorcycle, such as handling, braking, performance and safety. Do not carry loosely packed items that can shift. Securely pack your heaviest items close to the center of the motorcycle, and distribute the weight evenly from side to side. Properly adjust the suspension for your load, and check the condition and pressure of your tires. NEVER OVERLOAD YOUR MOTORCYCLE. Make sure the total weight of the cargo, rider, passenger, and accessories (fairing, saddlebags, etc. if approved for this model) does not exceed the maximum load of the motorcycle. Operation of an overloaded motorcycle could cause tire damage, an accident, or even injury.

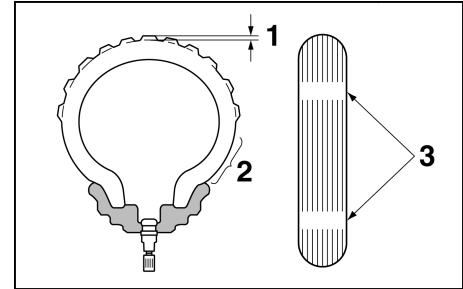

1. Tread depth
2. Side wall
3. Wear indicators

Tire inspection

Always check the tires before operating the motorcycle. If a tire tread shows crosswise lines (minimum tread depth), if the tire has a nail or glass fragments in it, or if the side wall is cracked, contact a Yamaha dealer immediately and have the tire replaced.

PERIODIC MAINTENANCE AND MINOR REPAIR

EW000079

⚠ WARNING

Operating the motorcycle with excessively worn tires decrease riding stability and can lead to loss of control. Have excessively worn tires replaced by a Yamaha dealer immediately. Brakes, tires, and related wheel parts replacement should be left to a Yamaha Service Technician.

Minimum tire tread depth (front and rear)	1.0 mm
---	--------

NOTE:

These limits may be different by regulation from country to country. If so, conform to the limits specified by the regulations of your own country.

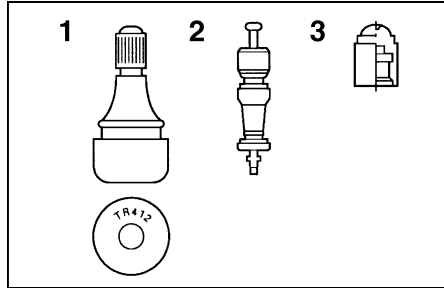

1. Tire valve
2. Valve core
3. Valve cap with seal

Tire information

This motorcycle is equipped with tubeless tires, tire valves and cast wheels.

EW000080

⚠ WARNING

- After extensive tests, the tires mentioned below have been approved by Yamaha Motor Co., Ltd. for this model. No guarantee for handling characteristics can be given if tire combinations other than what is approved are used on this motorcycle. The front and rear tires should be of the same manufacture and design.
- The use of tire valves and valve cores other than listed below could cause tire deflation during extreme high speed riding. Always use genuine parts or their equivalent for replacement.
- Be sure to install the valve caps securely, as these are important to prevent air pressure leakage during extreme high speed riding.

PERIODIC MAINTENANCE AND MINOR REPAIR

FRONT

Manufacturer	Size	Type
Bridgestone	120/60 ZR17 (55W)	BT56FE
Dunlop	120/60 ZR17 (55W)	D207FJ

REAR

Manufacturer	Size	Type
Bridgestone	180/55 ZR17 (73W)	BT56RE
Dunlop	180/55 ZR17 (73W)	D207N

	Type
Tire valve	TR412
Valve core	#9000A (original)

EAU00684

WARNING

This motorcycle is fitted with super high-speed running tires. The following points must be observed in order for you to make fully effective use of these tires.

- **Never fail to use the specified tires in tire replacement. Other tires may have a danger of bursting at super high-speeds.**
- **New tires have a relatively low grip on the road surface until they have been slightly worn. Therefore, approximately 100 km should be traveled at normal speed before any high-speed riding is done.**
- **Before any high-speed runs, the tires should be warmed-up sufficiently.**
- **Always inflate to the correct tire pressure according to the operating conditions.**

EAU00687

Wheels

To ensure maximum performance, long service, and safe operation, note the following:

- Always inspect the wheels before a ride. Check for cracks, bends, or warpage of the wheels. If any abnormal condition exists in a wheel, consult a Yamaha dealer. Do not attempt even small repairs to the wheel. If a wheel is deformed or cracked, it must be replaced.
- Tires and wheels should be balanced whenever either one is changed or replaced. Failure to have a wheel balanced can result in poor performance, adverse handling characteristics, and shortened tire life.
- Ride at moderate speeds after changing a tire since the tire surface must first be broken in for it to develop its optimal characteristics.

PERIODIC MAINTENANCE AND MINOR REPAIR

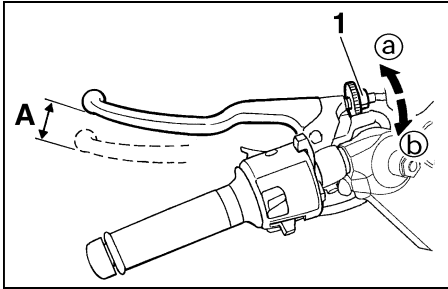

1. Adjusting bolt
- A. Free play

EAU01356

Clutch lever free play adjustment

The clutch lever free play should be adjusted to 10 ~ 15 mm.

1. Turn the adjusting bolt at the clutch lever in direction **a** to increase free play or in direction **b** to decrease free play. If the specified free play cannot be obtained, proceed with the following steps.
2. Turn the adjusting bolt at the clutch lever in direction **a** to loosen the cable.

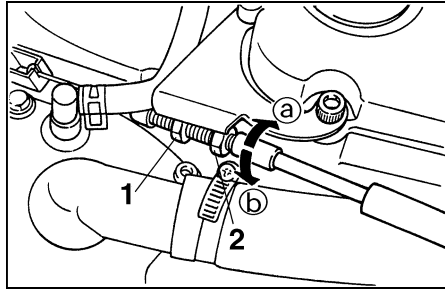

1. Locknut
2. Adjusting nut

3. Remove cowling A. (See page 6-6 for removal and installation procedures.)
4. Loosen the locknut at the crankcase side.
5. Turn the adjusting nut at the crankcase in direction **a** to increase free play or in direction **b** to decrease free play. Then tighten the locknut.
6. Install the cowling.

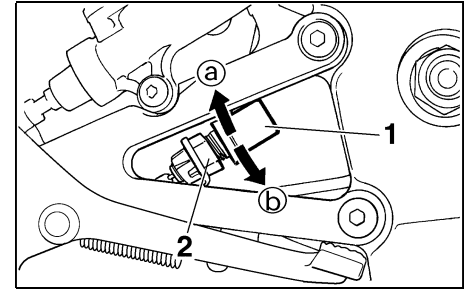

1. Brake light switch
2. Adjusting nut

EAU00713

Brake light switch adjustment

The rear brake light switch is activated by the brake pedal and is properly adjusted when the brake light comes on just before braking takes effect. To adjust the rear brake light switch, hold the switch body so it does not rotate while turning the adjusting nut.

Turn the adjusting nut in direction **a** to make the brake light come on earlier. Turn the adjusting nut in direction **b** to make the brake light come on later.

PERIODIC MAINTENANCE AND MINOR REPAIR

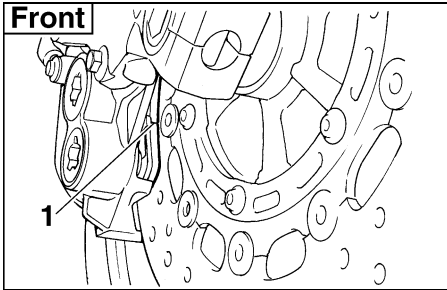

1. Wear indicator groove

EAU00721

Checking the front and rear brake pads

Front brake

A wear indicator groove is provided on each brake pad. This indicator allows checking of brake pad wear without disassembling the brake. Inspect the groove. If the groove has almost disappeared, ask a Yamaha dealer to replace the pads.

EAU00725

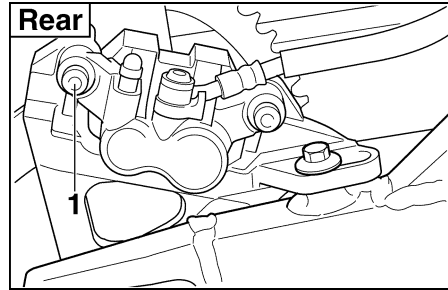

1. Caliper bolt

EAU01641

Rear brake

A wear indicator groove is provided on each brake pad. This indicator allows checking of brake pad wear without disassembling the brake. Remove the rear caliper bolt and tilt the caliper forward.

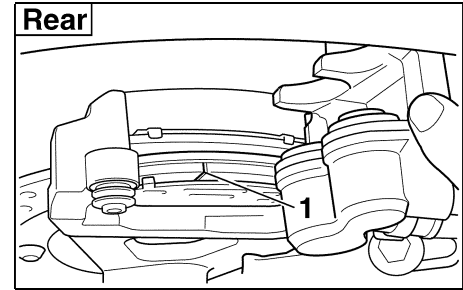

1. Wear indicator groove

Inspect the groove. If the groove has almost disappeared, ask a Yamaha dealer to replace the pads. Install the caliper and caliper bolt, then tighten the bolt to the specified torque.

Tightening torque:
Caliper bolt:
40 Nm (4.0 m·kg)

PERIODIC MAINTENANCE AND MINOR REPAIR

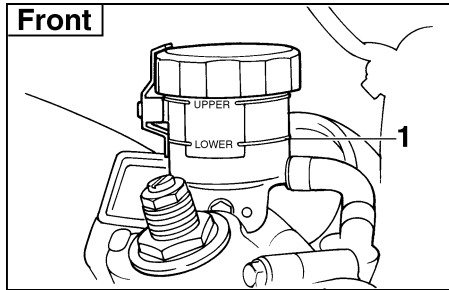

1. Minimum level mark

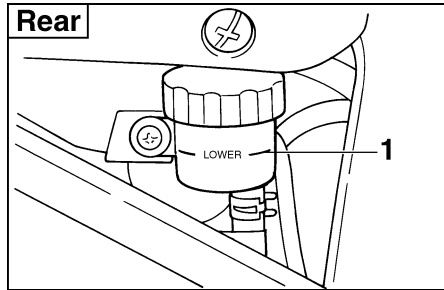

1. Minimum level mark

- Brake fluid may deteriorate painted surfaces or plastic parts. Always clean up spilled fluid immediately.
- Have a Yamaha dealer check the cause if the brake fluid level goes down.

Inspecting the brake fluid level

EAU00731

Insufficient brake fluid may let air enter the brake system, possibly causing the brakes to become ineffective.

Before riding, check that the brake fluid is above the minimum level and replenish when necessary.

Observe these precautions:

- When checking the fluid level, make sure the top of the master cylinder is level by turning the handlebars.

- Use only the designated quality brake fluid. Otherwise, the rubber seals may deteriorate, causing leakage and poor brake performance.

Recommended brake fluid: DOT 4

- Refill with the same type of brake fluid. Mixing fluids may result in a harmful chemical reaction and lead to poor brake performance.
- Be careful that water does not enter the master cylinder when refilling. Water will significantly lower the boiling point of the fluid and may result in vapor lock.

Brake fluid replacement

EAU00742

The brake fluid should be replaced only by trained Yamaha service personnel. Have the Yamaha dealer replace the following components during periodic maintenance or when they are damaged or leaking:

- oil seals (every two years)
- brake hoses (every four years)

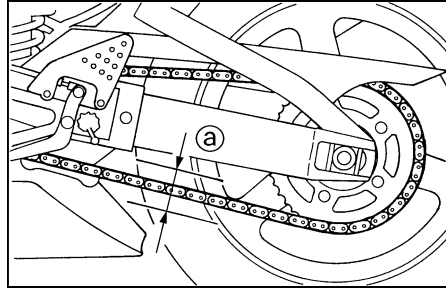

a. Chain slack

Drive chain slack check

EAU00744

NOTE:

Spin the wheel several times and find the tightest position of the chain. Check and/or adjust the chain slack while it's in this tightest position.

To check the chain slack the motorcycle must be held straight up with both wheels on the ground and without rider. Check the slack at the position shown in the illustration. Normal slack is approximately 40 ~ 50 mm. If the slack exceeds 50 mm, adjust.

PERIODIC MAINTENANCE AND MINOR REPAIR

EC000096

EAU03006

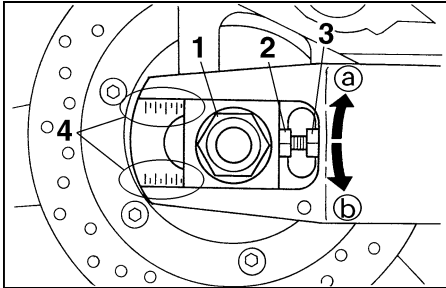

1. Axle nut
2. Adjusting bolt
3. Locknut
4. Alignment marks

EAU01251

Drive chain slack adjustment

1. Loosen the axle nut.
2. Loosen the locknuts on each side.
To tighten the chain, turn the chain adjusting bolts in direction Ⓐ. To loosen the chain, turn the adjusting bolts in direction Ⓑ and push the wheel forward. Turn each adjusting bolt exactly the same amount to maintain correct axle alignment. There are marks on each side of the swingarm. Use these marks to align the rear wheel.

CAUTION:

Too little chain slack will overload the engine and other vital parts. Keep the slack within the specified limits.

3. After adjusting, tighten the locknuts. Then tighten the axle nut to the specified torque.

Tightening torque:

Axle nut:
150 Nm (15 m·kg)

Drive chain lubrication

The chain consists of many parts which work with each other. If the chain is not maintained properly, it will wear out quickly. Therefore, the chain must be serviced regularly. This service is especially necessary when riding in dusty areas. This motorcycle is equipped with a sealed type chain. Steam cleaning, high-pressure washers, and solvents can damage the drive chain, so do not use these for cleaning it. Use only kerosene to clean the drive chain. Wipe it dry, and thoroughly lubricate it with SAE 30 ~ 50W motor oil. Do not use any other lubricants on the drive chain. They may contain solvents that could damage the sealed chain.

EC000097

CAUTION:

Be sure to oil the chain after washing the motorcycle or riding in the rain.

PERIODIC MAINTENANCE AND MINOR REPAIR

Cable inspection and lubrication

EAU02962

⚠ WARNING

Damage to the outer housing of cables may lead to internal rusting and interfere with the cable movement. Replace damaged cables as soon as possible to prevent unsafe conditions.

EW000112

Lubricate the cables and cable ends. If a cable does not operate smoothly, ask a Yamaha dealer to replace it.

Recommended lubricant:
Engine oil

Throttle cable and grip lubrication

EAU00773

The throttle twist grip assembly should be greased at the time that the cable is lubricated, since the grip must be removed to get at the end of the throttle cable. After removing the screws, hold the end of the cable up in the air and put in several drops of lubricant. With the throttle grip disassembled, coat the metal surface of the grip assembly with a suitable all-purpose grease.

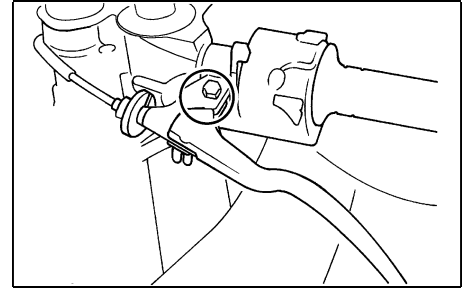

Brake and clutch lever lubrication

EAU02985

Lubricate the pivoting parts.

Recommended lubricant:
Engine oil

PERIODIC MAINTENANCE AND MINOR REPAIR

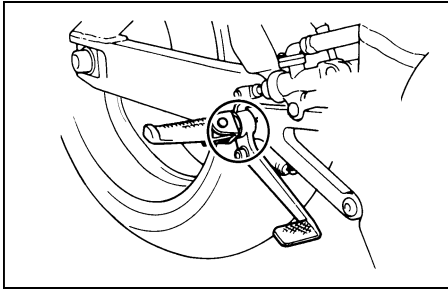

EAU01290*

Brake pedal lubrication

Lubricate the pivoting parts.

Recommended lubricant:
Engine oil

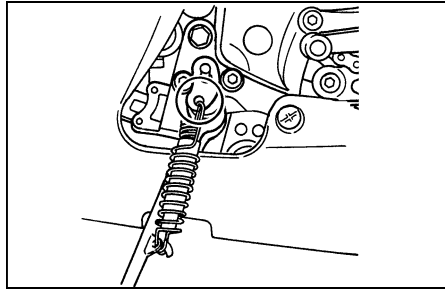

EAU00791

Rear suspension lubrication

Lubricate the pivoting parts.

Recommended lubricant:
Lithium soap base grease

EAU02986

Sidestand lubrication

Lubricate the sidestand pivoting point and metal-to-metal contact surfaces. Check that the sidestand moves up and down smoothly.

Recommended lubricant:
Engine oil

EW000113

WARNING

If the sidestand does not move smoothly, consult a Yamaha dealer.

PERIODIC MAINTENANCE AND MINOR REPAIR

Front fork inspection

Visual check

EAU02939

EW000115

WARNING

Securely support the motorcycle so there is no danger of it falling over.

Check for scratches or damage on the inner tube and excessive oil leakage from the front fork.

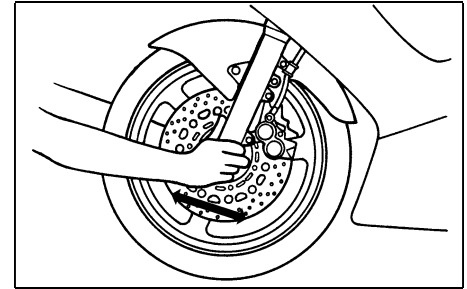
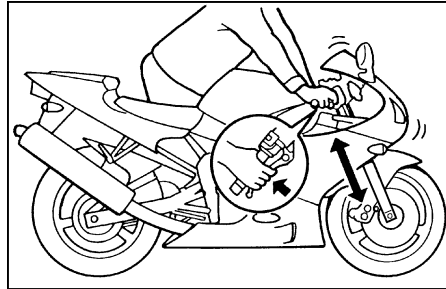

Operation check

1. Place the motorcycle on a level place.
2. Hold the motorcycle in an upright position and apply the front brake.
3. Push down hard on the handlebars several times and check if the fork rebounds smoothly.

EC000098

CAUTION:

If any damage or unsmooth movement is found with the front fork, consult a Yamaha dealer.

Steering inspection

Periodically inspect the condition of the steering. Worn out or loose steering bearings may be dangerous. Place a stand under the engine to raise the front wheel off the ground. Hold the lower end of the front forks and try to move them forward and backward. If any free play can be felt, ask a Yamaha dealer to inspect and adjust the steering. Inspection is easier if the front wheel is removed.

EAU00794

EW000115

WARNING

Securely support the motorcycle so there is no danger of it falling over.

PERIODIC MAINTENANCE AND MINOR REPAIR

Wheel bearings

EAU01144

If there is play in the front or rear wheel hub or if the wheel does not turn smoothly, have a Yamaha dealer inspect the wheel bearings.

Battery

EAU01291

This motorcycle is equipped with a sealed-type battery. Therefore it is not necessary to check the electrolyte or fill the battery with distilled water.

- If the battery seems to have discharged, consult a Yamaha dealer.
- If the motorcycle is equipped with optional electrical accessories, the battery tends to discharge more quickly, so be sure to recharge it periodically.

EW000116

WARNING

Battery electrolyte is poisonous and dangerous, causing severe burns, etc. It contains sulfuric acid. Avoid contact with skin, eyes or clothing.

ANTIDOTE:

- **EXTERNAL:** Flush with water.
- **INTERNAL:** Drink large quantities of water or milk. Follow with milk of magnesia, beaten egg, or vegetable oil. Call a physician immediately.
- **EYES:** Flush with water for 15 minutes and get prompt medical attention.

Batteries produce explosive gases. Keep sparks, flame, cigarettes etc., away. Ventilate when charging or using in an enclosed space. Always shield your eyes when working near batteries.

KEEP OUT OF REACH OF CHILDREN.

PERIODIC MAINTENANCE AND MINOR REPAIR

Battery storage

This motorcycle is equipped with a digital speedometer and the odometer memory tends to drain the battery. When the motorcycle is not used for a month or longer, be sure to remove the battery, fully charge it and store it in a cool, dry place.

EC000102

CAUTION:

- **Completely recharge the battery before storing. Storing a discharged battery can cause permanent battery damage.**
- **Use a battery charger designed for a sealed-type (MF) battery. Using a conventional battery charger will cause battery damage. If you do not have a sealed-type battery charger, contact your Yamaha dealer.**
- **Always make sure the connections are correct when reinstalling the battery.**

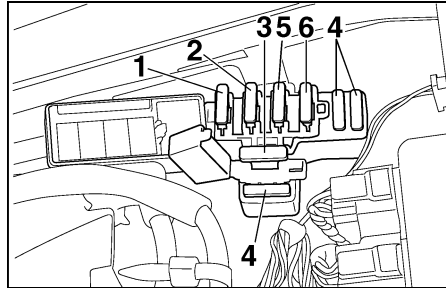

1. Ignition fuse
2. Headlight fuse
3. Signaling system fuse
4. Spare fuse (× 3)
5. Radiator fan fuse
6. Odometer fuse

EAU01754

Fuse replacement

The fuse boxes are located under the rider seat. If any fuse is blown, turn off the main switch and the switch of the circuit in question. Install a new fuse of specified amperage. Turn on the switches and see if the electrical device operates. If the fuse immediately blows again, consult a Yamaha dealer.

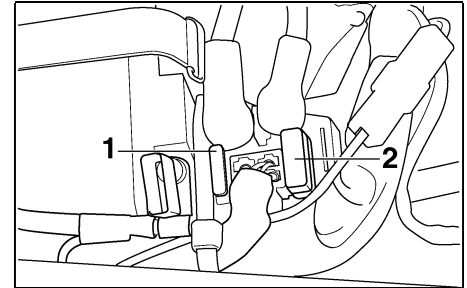

1. Main fuse
2. Spare fuse

EC000103

CAUTION:

Do not use fuses of higher amperage rating than those recommended. Substitution of a fuse of improper rating can cause extensive electrical system damage and possibly a fire.

PERIODIC MAINTENANCE AND MINOR REPAIR

Specified fuses:

Main fuse:	30 A
Headlight fuse:	20 A
Signaling system fuse:	20 A
Radiator fan fuse:	7.5 A
Ignition fuse:	15 A
Odometer fuse:	7.5 A

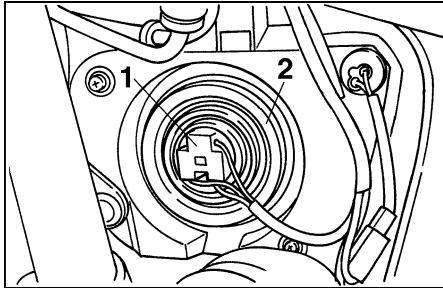

1. Connector
2. Bulb holder cover

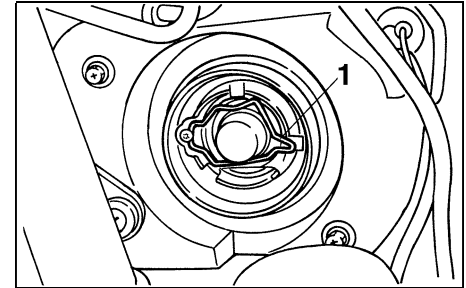

1. Bulb holder
3. Unhook the bulb holder and remove the defective bulb.

EAU01822

Headlight bulb replacement

This motorcycle is equipped with a quartz bulb headlight.

If the headlight bulb burns out, replace the bulb as follows:

1. Remove panel C. (See page 6-8 for panel removal and installation procedures.)
2. Remove the headlight connector and the bulb holder cover.

PERIODIC MAINTENANCE AND MINOR REPAIR

EC000104

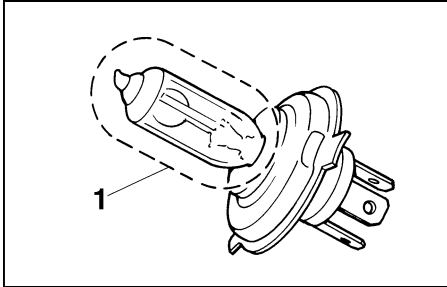

1. Don't touch

EW000119

! WARNING

Keep flammable products and your hands away from a bulb while it is on, as it is hot. Do not touch a bulb until it cools down.

4. Put a new bulb into position and secure it in place with the bulb holder.

CAUTION:

To prevent damage to the following:

- **Headlight bulb**

Avoid touching the glass part of the bulb. Keep it free from oil; otherwise, the transparency of the glass, life of the bulb, and illuminous flux will be adversely affected. If oil gets on the bulb, thoroughly clean it with a cloth moistened with alcohol or lacquer thinner.

- **Headlight lens**

- Do not affix any type of tinted film or stickers to the headlight lens.
- Do not use headlight bulbs of wattage higher than specified.

5. Install the bulb holder cover and reconnect the headlight connector. If the headlight beam adjustment is necessary, ask a Yamaha dealer to make that adjustment.

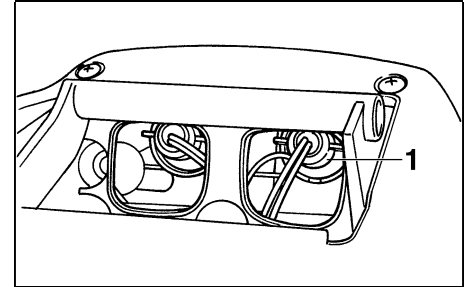

1. Bulb socket

EAU01823

Taillight bulb replacement

1. Remove the passenger seat. (See page 3-15 for seat removal and installation procedures.)
2. To remove the socket, turn it counterclockwise.
3. To remove the defective bulb, turn it counterclockwise.
4. Push a new bulb into the socket and turn it clockwise.
5. Install the socket and turn it clockwise.
6. Install the passenger seat.

PERIODIC MAINTENANCE AND MINOR REPAIR

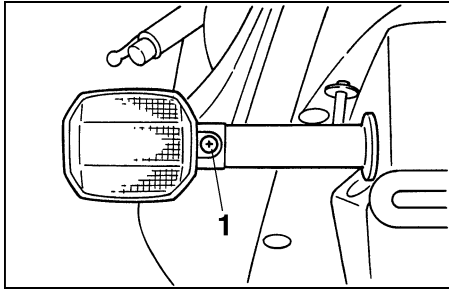

1. Screw

Turn signal light bulb replacement

1. Remove the screw and the lens.
2. Remove the defective bulb by pushing it inward and turning it counterclockwise.
3. Install a new bulb by pushing it inward and turning it clockwise.
4. Install the lens and tighten the screw.

EAU01095

EAU01579

Supporting the motorcycle

Since the Yamaha YZF-R6 has no centerstand, follow these precautions when removing the front and rear wheel or performing other maintenance requiring the motorcycle to stand upright. Check that the motorcycle is in a stable and level position before starting any maintenance. A strong wooden box can be placed under the engine for added stability.

Front wheel service

To stabilize the rear of the motorcycle, either use a motorcycle stand or place a motorcycle jack under the frame in front of the rear wheel to prevent it from moving from side to side. Then use a motorcycle stand to elevate the front wheel off of the ground.

Rear wheel service

Use a motorcycle stand or motorcycle jack to elevate the motorcycle so the rear wheel is off the ground. Alternatively, two jacks can be placed under the frame or swingarm.

PERIODIC MAINTENANCE AND MINOR REPAIR

EAU01638

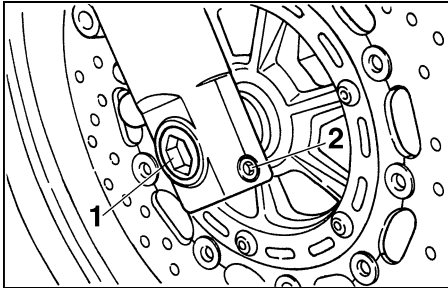

1. Wheel axle
2. Pinch bolt

EAU01617

Front wheel removal

EW000122

WARNING

- It is advisable to have a Yamaha dealer service the wheel.
- Securely support the motorcycle so there is no danger of it falling over.

1. Loosen the pinch bolt and caliper bolts.
2. Loosen the wheel axle by using a 19-mm hexagon wrench.

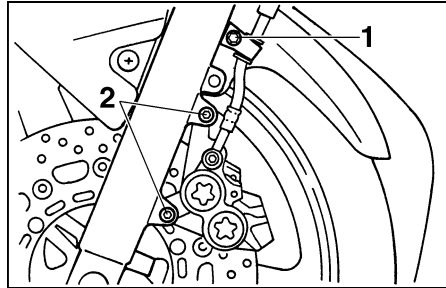

1. Brake hose holder bolt
2. Caliper bolt (× 2)
3. Elevate the front wheel.
4. Remove the brake hose holders and calipers.

NOTE: _____
Do not depress the brake lever when the calipers are off the discs as the brake pads will be forced shut.

5. Pull out the wheel axle and remove the wheel by pulling it backwards.

Front wheel installation

1. Lift up the wheel between the front fork legs.
2. Install the wheel axle and let the motorcycle down.
3. Push down hard on the handlebars several times to check for proper fork operation.
4. Install the calipers, caliper bolts and brake hose holders. Make sure there is enough gap between the brake pads before installing the calipers onto the brake discs.
5. Tighten the wheel axle, pinch bolt and caliper bolts to the specified torques.

Tightening torque:

Wheel axle:
72 Nm (7.2 m·kg)

Pinch bolt:
20 Nm (2.0 m·kg)

Caliper bolt:
40 Nm (4.0 m·kg)

PERIODIC MAINTENANCE AND MINOR REPAIR

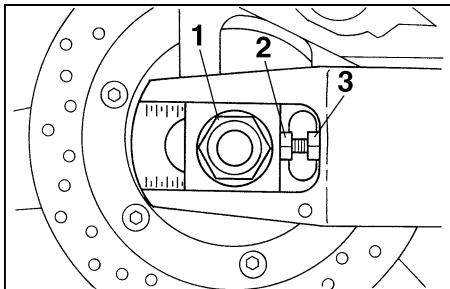

1. Axle nut
2. Adjusting bolt
3. Locknut

EAU01247

Rear wheel removal

EW000122

⚠ WARNING

- It is advisable to have a Yamaha dealer service the wheel.
- Securely support the motorcycle so there is no danger of it falling over.

1. Loosen the axle nut and caliper bolts.
2. Elevate the rear wheel.

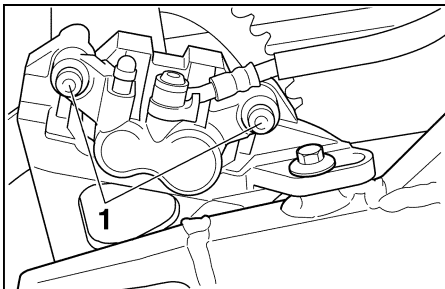

1. Caliper bolt (× 2)

3. Remove the axle nut, caliper bolts and caliper.
4. Loosen the locknuts on each side of the swingarm.
5. Turn the chain adjusting bolts fully inward.
6. Push the wheel forward and remove the drive chain.
7. Pull out the wheel axle and remove the wheel assembly by pulling backwards.

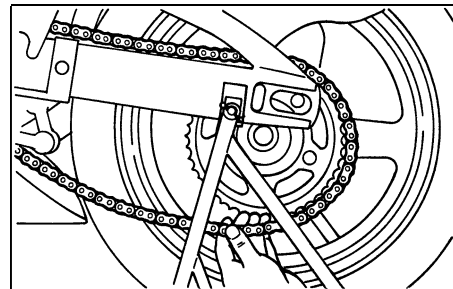

NOTE:

- Do not depress the brake pedal when the caliper is off the disc as the brake pads will be forced shut.
- You do not have to disassemble the chain in order to remove or install the rear wheel.

EAU01246

Rear wheel installation

1. Install the wheel assembly and insert the axle.
2. Install and adjust the drive chain. (See page 6-28 for details about adjusting the drive chain slack.)
3. Install the axle nut and let the motorcycle down.
4. Install the caliper and caliper bolts. Make sure there is enough gap between the brake pads before installing the caliper onto the brake disc.
5. Tighten the axle nut and caliper bolts to the specified torques.

Tightening torque:

Axle nut:

150 Nm (15.0 m·kg)

Caliper bolt:

40 Nm (4.0 m·kg)

EAU01008

Troubleshooting

Although Yamaha motorcycles receive a rigid inspection before shipment from the factory, trouble may occur during operation.

Any problem in the fuel, compression, or ignition systems can cause poor starting and loss of power. The troubleshooting chart describes a quick, easy procedure for making checks.

If your motorcycle requires any repair, bring it to a Yamaha dealer. The skilled technicians at a Yamaha dealership have the tools, experience, and know-how to properly service your motorcycle. Use only genuine Yamaha parts on your motorcycle. Imitation parts may look like Yamaha parts, but they are often inferior. Consequently, they have a shorter service life and can lead to expensive repair bills.

PERIODIC MAINTENANCE AND MINOR REPAIR

Troubleshooting chart

EAU02990

EW000125



WARNING

Never check the fuel system while smoking or in the vicinity of an open flame.

1. Fuel

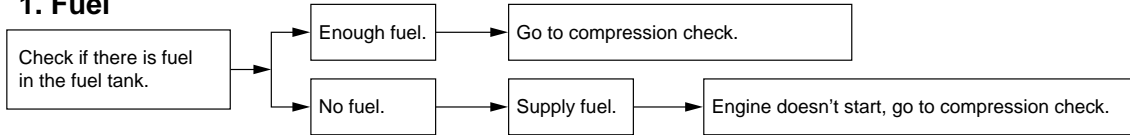

2. Compression

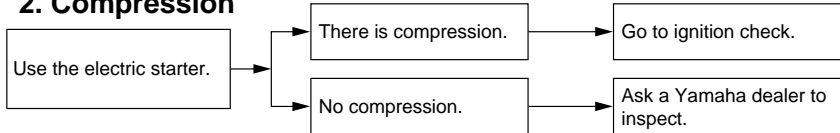

3. Ignition

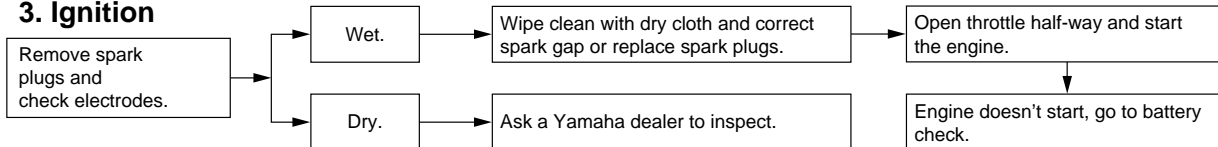

4. Battery

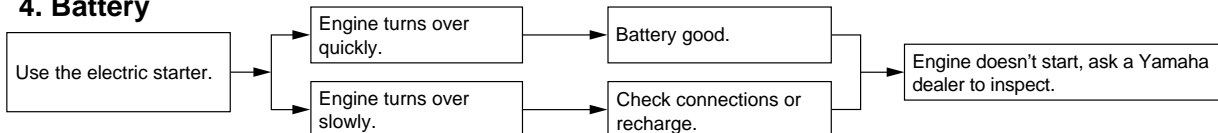

PERIODIC MAINTENANCE AND MINOR REPAIR

5. Engine overheating

EW000070

WARNING

Do not remove the radiator cap when the engine and radiator are hot. Scalding hot fluid and steam may be blown out under pressure, which could cause serious injury. Open the radiator cap as follows. Wait until the engine has cooled. Remove the radiator cap stopper by removing the screw. Place a thick rag like a towel over the radiator cap and slowly rotate the cap counterclockwise to the detent. This procedure allows any residual pressure to escape. When the hissing sound has stopped, press down on the cap while turning counterclockwise and remove it.

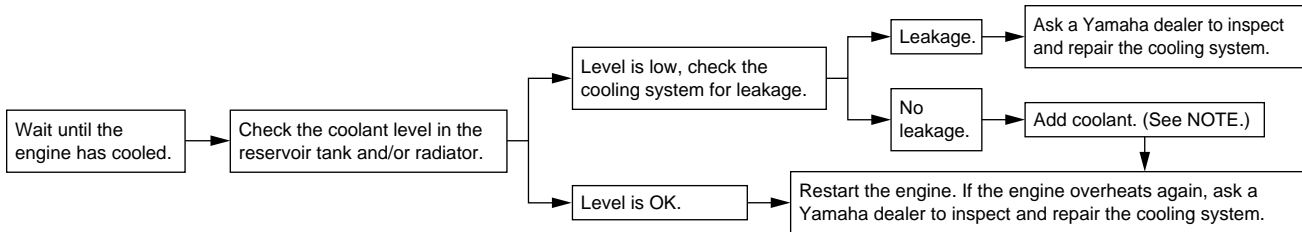

NOTE:

If it is difficult to get the recommended coolant, tap water can be temporarily used, provided that it is changed to the recommended coolant as soon as possible.

MOTORCYCLE CARE AND STORAGE

Care	7-1
Storage.....	7-4

Care

The exposure of its technology makes a motorcycle charming but also vulnerable. Although high-quality components are used, they are not all rust-resistant. While a rusty exhaust pipe may remain unnoticed on a car, it does look unattractive on a motorcycle. Frequent and proper care, however, will keep your motorcycle looking good, extend its life and maintain its performance. Moreover, the warranty states that the vehicle must be properly taken care of. For all these reasons, it is recommended that you observe the following cleaning and storing precautions.

Before cleaning

1. Cover up the muffler outlet with a plastic bag.
2. Make sure that all caps and covers as well as all electrical couplers and connectors, including the spark plug caps, are tightly installed.
3. Remove extremely stubborn dirt, like oil burnt onto the crankcase, with a degreasing agent and a brush, but never apply such products onto seals, gaskets, sprockets, the drive chain and wheel axles. Always rinse the dirt and degreaser off with water.

Cleaning

After normal use

Remove dirt with warm water, a neutral detergent and a soft clean sponge, then rinse with plenty of clean water. Use a tooth or bottle brush for hard-to-reach parts. Tougher dirt and insects will come off more easily if the area is covered with a wet cloth for a few minutes before cleaning. There is a special sponge included in the plastic bag containing the owners manual. Use this sponge to clean the muffler and to remove any discoloration from the muffler.

MOTORCYCLE CARE AND STORAGE

ECA00010

CAUTION:

- Avoid using strong acidic wheel cleaners, especially on spoked wheels. If you do use such products for hard-to-remove dirt, do not leave it on any longer than instructed, then thoroughly rinse it off with water, immediately dry the area and apply a corrosion protection spray.
- Improper cleaning can damage windshields, cowlings, panels and other plastic parts. Use only a soft, clean cloth or sponge with mild detergent and water to clean plastic.
- Do not use any harsh chemical products on plastic parts. Be sure to avoid using cloths or sponges which have been in contact with strong or abrasive cleaning products, solvent or thinner, fuel (gasoline), rust removers or inhibitors, brake fluid, antifreeze or electrolyte.
- Do not use high-pressure washers or steam-jet cleaners since they cause water seepage and deterioration in the following areas: seals (of wheel bearings, swingarm bearings, forks and brakes), electric components (couplers, connectors, instruments, switches and lights), breather hoses and vents.
- For motorcycles equipped with a windshield: Do not use strong cleaners or hard sponges as they will cause dulling or scratching. Some cleaning compounds for plastic may leave scratches on the windshield. Test the product on a small hidden part of the windshield to make sure they do not leave any marks. If the windshield is scratched, use a quality plastic polishing compound after washing.

After riding in the rain, near the sea or on salt-sprayed roads

Since sea salt or salt sprayed on the roads in the winter are extremely corrosive in combination with water, carry out the following steps after each ride in the rain, near the sea or on salt-sprayed roads. (Salt sprayed in the winter may remain on the roads well into spring.)

MOTORCYCLE CARE AND STORAGE

1. Clean your motorcycle with cold water and soap after the engine has cooled down.

ECA00012

CAUTION:

Do not use warm water since it increases the corrosive action of the salt.

2. Be sure to apply a corrosion protection spray on all (even chrome- and nickel-plated) metal surfaces to prevent corrosion.

After cleaning

1. Dry the motorcycle with a chamois or an absorbing cloth.
2. Immediately dry the drive chain and lubricate it to prevent it from rusting.
3. Use a chrome polish to shine chrome, aluminum and stainless-steel parts, including the exhaust system. (Even the thermally induced discoloring of stainless-steel exhaust systems can be removed through polishing.)
4. To prevent corrosion, it is recommended to apply a corrosion protection spray on all (even chrome- and nickel-plated) metal surfaces.
5. Use spray oil as a universal cleaner to remove any remaining dirt.
6. Touch up minor paint damage caused by stones, etc.
7. Wax all painted surfaces.
8. Let the motorcycle dry completely before storing it or covering it.

EWA00001

! WARNING

Make sure that there is no oil or wax on the brakes and tires. If necessary, clean the brake discs and linings with a regular brake disc cleaner or acetone, and wash the tires with warm water and mild soap. Then, carefully test the motorcycle for its braking performance and cornering behavior.

MOTORCYCLE CARE AND STORAGE

ECA00013

CAUTION:

- Apply spray oil and wax sparingly and wipe off any excess.
- Never apply oil or wax on rubber and plastic parts, but treat them with a suitable care product.
- Avoid using abrasive polishing compounds as they wear away the paint.

NOTE:

Consult a Yamaha dealer for advice on what products to use.

Storage

Short-term

Always store your motorcycle in a cool, dry place and, if necessary, protect it against dust with a porous cover.

ECA00014

CAUTION:

- Storing the motorcycle in a poorly ventilated room or covering it with a tarp while it is still wet will allow water and humidity to seep in and cause rust.
- To prevent corrosion, avoid damp cellars, stables (because of the presence of ammonia) and areas where strong chemicals are stored.

Long-term

Before storing your motorcycle for several months:

1. Follow all the instructions in the “Care” section of this chapter.
2. Drain the carburetor float chambers by loosening the drain bolts; this will prevent fuel deposits from building up. Pour the drained fuel into the fuel tank.
3. Only for motorcycles equipped with a fuel cock which has an “OFF” position: Turn the fuel cock to “OFF”.
4. Fill up the fuel tank and add fuel stabilizer (if available) to prevent the fuel tank from rusting and the fuel from deteriorating.
5. Perform the following steps to protect the cylinders, piston rings, etc. from corrosion.

MOTORCYCLE CARE AND STORAGE

- a. Remove the spark plug caps and spark plugs.
- b. Pour a teaspoonful of engine oil into each spark plug bore.
- c. Install the spark plug caps onto the spark plugs and place the spark plugs on the cylinder head so that the electrodes are grounded. (This will limit sparking during the next step.)
- d. Turn the engine over several times with the starter. (This will coat the cylinder walls with oil.)
- e. Remove the spark plug caps from the spark plugs, install the spark plugs and then the spark plug caps.
6. Lubricate all control cables and the pivoting points of all levers and pedals as well as of the sidestand/centerstand.
7. Check and, if necessary, correct the tire air pressure, then raise the motorcycle so that both of its wheels are off the ground. Alternatively, turn the wheels a little every month in order to prevent the tires from becoming degraded in one spot.
8. Cover up the muffler outlet with a plastic bag to prevent moisture from entering.
9. Remove the battery and fully charge it. Store it in a cool, dry place and recharge it once a month. Do not store the battery in an excessively cold or warm place (less than 0°C or more than 30°C). For more information, see “Battery storage” in the chapter “PERIODIC MAINTENANCE AND MINOR REPAIRS”.

NOTE: _____
Make any necessary repairs before storing the motorcycle.

7

EWA00003

 **WARNING**

When turning the engine over, be sure to ground the spark plug electrodes to prevent damage or injury from sparking.

Specifications 8-1
HOW TO USE THE CONVERSION TABLE 8-5

Specifications

Model	YZF-R6
Dimensions	
Overall length	2,075 mm
Overall width	690 mm
Overall height	1,105 mm
Seat height	820 mm
Wheelbase	1,380 mm
Ground clearance	135 mm
Minimum turning radius	3,400 mm
Basic weight (with oil and full fuel tank)	188 kg
Engine	
Engine type	Liquid-cooled 4-stroke, DOHC
Cylinder arrangement	Forward-inclined parallel 4-cylinder
Displacement	600 cm ³
Bore × Stroke	65.5 × 44.5 mm
Compression ratio	12.4:1
Starting system	Electric starter
Lubrication system	Wet sump

Engine oil

Type

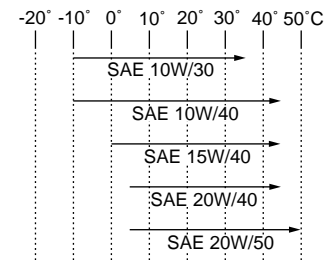

Recommended engine oil
classification

API Service SE, SF, SG type or
higher

CAUTION:

Be sure to use motor oils that do not contain anti-friction modifiers. Passenger car motor oils (often labeled “Energy Conserving”) contain anti-friction additives which will cause clutch and/or starter clutch slippage, resulting in reduced component life and poor engine performance.

Quantity

Periodic oil change	2.5 L
With oil filter replacement	2.7 L
Total amount	3.5 L

Radiator

Quantity (including all routes) 2.15 L

Air filter

Wet type element

Fuel

Type Regular gasoline
Unleaded fuel only (for Australia)

Fuel tank capacity 17 L

Fuel reserve amount 3.5 L

Carburetor

Type × quantity CVRD37 × 4

Manufacturer KEIHIN

Spark plug

Type/Manufacturer CR10EK / NGK

Gap 0.6 ~ 0.7 mm

Clutch type

Wet, multiple-disc

Transmission

Primary reduction system Spur gear

Primary reduction ratio 1.955

Secondary reduction system Chain drive

Secondary reduction ratio 3.000

Transmission type Constant mesh 6-speed

Operation Left foot operation

Gear ratio

1st 2.846

2nd 1.947

3rd 1.556

4th 1.333

5th 1.190

6th 1.083

Chassis

Frame type Diamond

Caster angle 24°

Trail 81 mm

Tire

Type Tubeless

Front

Size 120/60 ZR17 (55 W)

Manufacturer/
model Bridgestone / BT56FE
Dunlop / D207FJ

Rear

Size 180/55 ZR17 (73 W)

Manufacturer/
model Bridgestone / BT56RE
Dunlop / D207N

Maximum load* 187 kg

Air pressure (cold tire)

SPECIFICATIONS

Up to 90 kg load*

Front	250 kPa (2.50 kgf/cm ² , 2.50 bar)
Rear	250 kPa (2.50 kgf/cm ² , 2.50 bar)

90 kg load ~ maximum load*

Front	250 kPa (2.50 kgf/cm ² , 2.50 bar)
Rear	290 kPa (2.90 kgf/cm ² , 2.90 bar)

High speed riding

Front	250 kPa (2.50 kgf/cm ² , 2.50 bar)
Rear	250 kPa (2.50 kgf/cm ² , 2.50 bar)

* Load is total weight of cargo, rider, passenger and accessories.

Wheels

Front

Type	Cast
Size	17 × MT 3.50

Rear

Type	Cast
Size	17 × MT 5.50

Brakes

Front

Type	Dual disc brake
Operation	Right hand operation
Fluid	DOT 4

Rear

Type	Single disc brake
Operation	Right foot operation
Fluid	DOT 4

Suspension

Front

Type	Telescopic fork
------	-----------------

Rear

Type	Swingarm (link suspension)
------	----------------------------

Shock absorbers

Front

Coil spring / oil damper

Rear

Coil spring / gas-oil damper

Wheel travel

Front

130 mm

Rear

120 mm

Electrical system

Ignition system

C.D.I.

Charging system

Type

A.C. magneto

Standard output

14 V, 320 W@ 5,000 r/min

Battery

Type

GT12B-4

Voltage, capacity

12 V, 10 AH

Headlight type	Quartz bulb (halogen)
Bulb voltage, wattage × quantity	
Headlight	12 V, 60/55 W × 2
Tail/brake light	12 V, 5/21 W × 2
Turn signal light	12 V, 21 W × 4
Meter light	12 V, 1.4 W × 2
Neutral indicator light	LED
High beam indicator light	LED
Turn indicator light	LED
Fuel indicator light	LED
Oil level/coolant temperature indicator light	LED
Fuses	
Main fuse	30 A
Headlight fuse	20 A
Signaling system fuse	20 A
Radiator fan fuse	7.5 A
Ignition fuse	15 A
Odometer fuse	7.5 A

SPECIFICATIONS

EAU01064

HOW TO USE THE CONVERSION TABLE

All specification data in this manual are listed in SI and METRIC UNITS.

Use this table to convert METRIC unit data to IMPERIAL unit data.

Ex.

METRIC		MULTIPLIER	=	IMPERIAL
**mm	×	0.03937	=	**in
2 mm	×	0.03937	=	0.08 in

CONVERSION TABLE

METRIC TO IMPERIAL			
	Metric unit	Multiplier	Imperial unit
Torque	m-kg	7.233	ft-lb
	m-kg	86.794	in-lb
	cm-kg	0.0723	ft-lb
	cm-kg	0.8679	in-lb
Weight	kg	2.205	lb
	g	0.03527	oz
Speed	km/hr	0.6214	mph
Distance	km	0.6214	mi
	m	3.281	ft
	m	1.094	yd
	cm	0.3937	in
	mm	0.03937	in
Volume / Capacity	cc (cm ³)	0.03527	oz (IMP liq.)
	cc (cm ³)	0.06102	cu-in
	lt (liter)	0.8799	qt (IMP liq.)
	lt (liter)	0.2199	gal (IMP liq.)
Misc.	kg/mm	55.997	lb/in
	kg/cm ²	14.2234	psi (lb/in ²)
	Centigrade (°C)	9/5 + 32	Fahrenheit (°F)

Identification number records.....	9-1
Key identification number	9-1
Vehicle identification number.....	9-1
Model label.....	9-2
NOISE REGULATION (For Australia).....	9-2

Identification number records

EAU02944

Record the key identification number, vehicle identification number and model label information in the spaces provided for assistance when ordering spare parts from a Yamaha dealer or for reference in case the vehicle is stolen.

1. KEY IDENTIFICATION NUMBER:

2. VEHICLE IDENTIFICATION NUMBER:

3. MODEL LABEL INFORMATION:

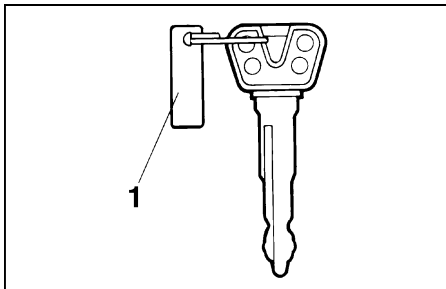

1. Key identification number

EAU01041

Key identification number

The key identification number is stamped on the key tag. Record this number in the space provided and use it for reference when obtaining a new key.

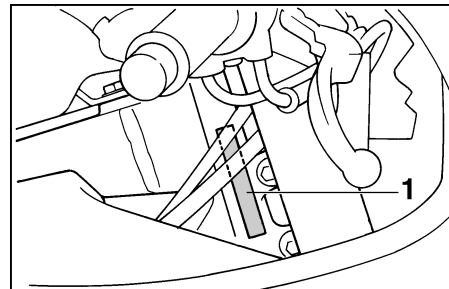

1. Vehicle identification number

EAU01043

Vehicle identification number

The vehicle identification number is stamped into the steering head pipe. Record this number in the space provided.

NOTE:

The vehicle identification number is used to identify your motorcycle and may be used to register your motorcycle with the licensing authority in your state.

EAU01388

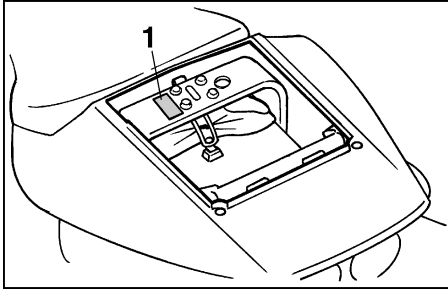

1. Model label

EAU01050

Model label

The model label is affixed to the frame under the seat. (See page 3-15 for seat removal procedures.) Record the information on this label in the space provided. This information will be needed to order spare parts from your Yamaha dealer.

NOISE REGULATION (For Australia)

TAMPERING WITH NOISE CONTROL SYSTEM PROHIBITED

Owners are warned that the law may prohibit:

- (a) The removal or rendering inoperative by any person other than for purposes of maintenance, repair or replacement, of any device or element of design incorporated into any new vehicle for the purpose of noise control prior to its sale or delivery to the ultimate purchaser or while it is in use; and
- (b) The use of the vehicle after such device or element of design has been removed or rendered inoperative by any person.

INDEX

A

- Air filter6-17
- Air intake duct6-19

B

- Battery6-33
- Brake and clutch lever lubrication.....6-30
- Brake fluid replacement6-28
- Brake light switch adjustment.....6-25
- Brake pedal lubrication.....6-31

C

- Cable inspection and lubrication6-30
- Carburetor adjustment6-20
- Care7-1
- Changing the coolant6-14
- Checking the front and rear brake pads6-26
- Clutch lever3-11
- Clutch lever free play adjustment6-25
- Controls/Instruments2-3
- Cooling system6-13
- Cowling and panel removal and installation6-6
- Cowlings A and B6-6

D

- Diagnosis device3-9
- Digital speedometer3-7
- Dimmer switch3-9
- Drive chain lubrication6-29
- Drive chain slack adjustment.....6-29
- Drive chain slack check.....6-28

E

- Engine break-in5-5
- Engine oil6-10
- Engine stop switch.....3-10

F

- Front brake lever3-11
- Front fork adjustment.....3-17
- Front fork inspection6-32
- Front wheel installation6-38
- Front wheel removal6-38
- Fuel3-13
- Fuel indicator light3-2
- Fuel indicator light circuit check3-6
- Fuel tank cap3-13
- Fuse replacement.....6-34

G

- Gasoline and exhaust gas1-5

H

- Handlebar switches3-9
 - Dimmer switch3-9
 - Engine stop switch3-10
 - Horn switch3-10
 - Pass switch3-9
 - Start switch3-10
 - Turn signal switch3-10
- Headlight bulb replacement6-35
- Helmet holder3-16
- High beam indicator light3-2
- Horn switch3-10

I

- Identification number records9-1
- Idle speed adjustment6-20
- Indicator lights3-2
 - Fuel indicator light.....3-2
 - High beam indicator light3-2
 - Neutral indicator light3-2
 - Oil level/coolant temperature indicator light.....3-3
 - Turn indicator light3-2
- Inspecting the brake fluid level6-27

K

- Key identification number9-1

L

- Left view2-1
- Loading and accessories1-3
- Location of the important labels.....1-7
- Luggage strap holders3-22

M

- Main switch/steering lock3-1
- Model label9-2
- Modification1-3

N

- Neutral indicator light3-2
- Noise regulation (For Australia).....9-2

O

- Oil level/coolant temperature indicator light.....3-3
- Oil level/coolant temperature indicator light circuit check3-5

P

Panel C	6-8
Parking	5-5
Pass switch	3-9
Periodic maintenance and lubrication	6-3
Pre-operation check list	4-1
Protective apparel.....	1-3

R

Rear brake pedal	3-12
Rear shock absorber adjustment	3-19
Rear suspension lubrication.....	6-31
Rear wheel installation.....	6-40
Rear wheel removal.....	6-39
Recommended combinations of the front fork and the rear shock absorber settings.....	3-21
Right view	2-2

S

Safe riding	1-1
Seats	3-15
Shifting	5-4
Shift pedal	3-11
Sidestand	3-22
Sidestand/clutch switch operation check	3-23
Sidestand lubrication	6-31
Spark plug inspection	6-9
Specifications	8-1
Starter (choke) “ ↘ ”	3-14
Starting and warming up a cold engine....	5-1
Starting a warm engine.....	5-3
Start switch.....	3-10

Steering inspection.....	6-32
Storage	7-4
Storage compartment.....	3-16
Supporting the motorcycle.....	6-37

T

Tachometer.....	3-8
Taillight bulb replacement	6-36
Throttle cable and grip lubrication.....	6-30
Throttle cable free play inspection	6-21
Tips for reducing fuel consumption.....	5-4
Tires.....	6-21
Tool kit	6-1
Troubleshooting	6-40
Troubleshooting chart	6-41
Turn indicator light.....	3-2
Turn signal light bulb replacement.....	6-37
Turn signal switch	3-10

V

Valve clearance adjustment	6-21
Vehicle identification number.....	9-1

W

Wheel bearings	6-33
Wheels.....	6-24



PRINTED ON RECYCLED PAPER

PRINTED IN JAPAN
99 · 10 - 0.4 × 1 CR
(E)