



Includes:

- Important Safety Information
- Operating Instructions
- Maintenance and Storage

VULCAN 1700 VOYAGER
VULCAN 1700 VOYAGER ABS
Motorcycle

OWNER'S MANUAL

Quick Reference Guide

This Quick Reference Guide will assist you in finding the information you're looking for.

GENERAL INFORMATION

HOW TO RIDE THE MOTORCYCLE

SAFE OPERATION

MAINTENANCE AND ADJUSTMENT

STORAGE

TROUBLESHOOTING GUIDE

A Table of Contents is included after the Foreword.

iPod® is a trademark of Apple Inc. registered in the U.S.A. and in certain other countries.

XM® is a trademark of XM Satellite Radio Inc. registered in the U.S.A. and in certain other countries.

Whenever you see the symbols shown below, heed their instructions! Always follow safe operating and maintenance practices.

 **DANGER**

DANGER indicates a hazardous situation which, if not avoided, will result in death or serious injury.

 **WARNING**

WARNING indicates a hazardous situation which, if not avoided, could result in death or serious injury.

NOTICE

NOTICE is used to address practices not related to personal injury.

NOTE

- *NOTE* indicates information that may help or guide you in the operation or service of the vehicle.

 WARNING

Engine exhaust, some of its constituents, and certain vehicle components contain or emit chemicals known to the State of California to cause cancer and birth defects or other reproductive harm.

NOTICE

THIS PRODUCT HAS BEEN MANUFACTURED FOR USE IN A REASONABLE AND PRUDENT MANNER BY A QUALIFIED OPERATOR AND AS A VEHICLE ONLY.

FOREWORD

Congratulations on your purchase of a new Kawasaki Motorcycle. Your new motorcycle is the product of Kawasaki's advanced engineering, exhaustive testing, and continuous striving for superior reliability, safety and performance.

Please read this Owner's Manual carefully before riding so that you will be thoroughly familiar with the proper operation of your motorcycle's controls, its features, capabilities, and limitations. This manual offers many safe riding tips, but its purpose is not to provide instruction in all the techniques and skills required to ride a motorcycle safely. Kawasaki strongly recommends that all operators of this vehicle enroll in a motorcycle rider training program to attain awareness of the mental and physical requirements necessary for safe motorcycle operation.

To ensure a long, trouble-free life for your motorcycle, give it the proper care and maintenance described in this manual. For those who would like more detailed information on their Kawasaki Motorcycle, a Service Manual is available for purchase from any authorized Kawasaki motorcycle dealer. The Service Manual contains detailed disassembly and maintenance information. Those who plan to do their own work should, of course, be competent mechanics and possess the special tools described in the Service Manual.

Keep this Owner's Manual aboard your motorcycle at all times so that you can refer to it whenever you need information.

This manual should be considered a permanent part of the motorcycle and should remain with the motorcycle when it is sold.

All rights reserved. No part of this publication may be reproduced without our prior written permission.

This publication includes the latest information available at the time of printing. However, there may be minor differences between the actual product and illustrations and text in this manual.

All products are subject to change without prior notice or obligation.

KAWASAKI HEAVY INDUSTRIES, LTD.
Motorcycle & Engine Company

TABLE OF CONTENTS

SPECIFICATIONS	10	PTT (Push to Talk).....	66
Serial Number Locations	14	Left Handlebar Switches	67
LOCATION OF PARTS	15	Dimmer Switch	67
LOADING INFORMATION	18	Turn Signal Switch.....	68
GENERAL INFORMATION	21	Horn Button	68
Meter Instruments	21	Audio Control Switches	68
Speedometer and Tachometer	22	Right Handlebar Switches.....	68
Meter Unit Switch	23	Hazard Switch	68
Multifunction Meter	24	Engine Stop Switch	69
Setting Menu	30	Starter Button	69
Warning/Indicator Lights	32	Meter Unit Switch	69
Service Code	35	Electronic Cruise Control ON/OFF Button.....	69
Keys	36	Electronic Cruise Control Switch (SET/- and RES/+)	70
Ignition Switch/Steering Lock.....	37	Electronic Cruise Control System	70
Audio System	40	Electronic Cruise Control Indicator Light	71
Important Notice	40	Electronic Cruise Control Set Indicator Light.....	71
Operating Precautions.....	40		
Getting Started	44		
Radio Power On/Off.....	45		
Radio (FM/AM/WX BAND).....	45		

Electronic Cruise Control Switch (SET/- and RES/+)	72	Accessory Socket/Connectors	98
To Set the Electronic Cruise Control.....	73	BREAK-IN	104
To Increase the set speed	74	HOW TO RIDE THE MOTORCYCLE .	106
To Decrease the set speed	75	Starting the Engine	106
To Cancel the Electronic Cruise Control.....	75	Jump Starting.....	109
Brake Lever and Clutch Lever		Moving Off.....	112
Adjusters.....	77	Shifting Gears	113
Fog Light Switch.....	78	Braking	115
Fuel Tank Cap.....	79	Kawasaki Advanced	
Fuel Tank	80	Coactive-braking Technology	
Stand.....	84	(K-ACT) - Anti-lock Brake System	
Seat.....	85	(ABS) for models equipped with	
Tool Kit	88	K-ACT ABS.....	116
Leg Louvers	88	K-ACT ABS Indicator Light	119
Special Warning on the Use of		Stopping the Engine.....	120
Fairing Pockets, Saddlebags, and		Stopping the Motorcycle in an	
Travel Trunk.....	89	Emergency	121
Fairing Pockets	91	Parking	122
Saddlebags	92	Catalytic Converter.....	123
Travel Trunk	96	Electronic Throttle Valve (ETV)	
		System.....	125
		SAFE OPERATION	126
		Safe Riding Technique	126

Daily Checks	129	Brake Light Switches.....	180
Additional Considerations for High Speed Operation	131	Rear Shock Absorbers	182
MAINTENANCE AND ADJUSTMENT	133	Wheels	186
Periodic Maintenance Chart.....	137	Battery.....	192
Engine Oil	150	Headlight Beam.....	199
Cooling System	157	Fuses	200
Drive Belt.....	163	General Lubrication.....	202
Spark Plugs.....	164	Cleaning Your Motorcycle	204
Evaporative Emission Control System (California model only)	165	Bolt and Nut Tightening.....	210
Valve Clearance	166	STORAGE	213
Kawasaki Clean Air System.....	166	TROUBLESHOOTING GUIDE	216
Air Cleaner	167	YOUR WARRANTY/OWNER	
Throttle Control System	169	SATISFACTION	217
Idle Speed.....	171	REPORTING SAFETY DEFECTS	223
Clutch.....	174	ENVIRONMENTAL PROTECTION	224
Brakes.....	175	MAINTENANCE RECORD	225
		LOCATION OF LABELS	229

10 SPECIFICATIONS

SPECIFICATIONS

DIMENSIONS

Overall Length 2 560 mm (100.79 in.)

Overall Width 995 mm (39.17 in.)

Overall Height 1 550 mm (61.02 in.)

Wheelbase 1 665 mm (65.55 in.)

Road Clearance 135 mm (5.31 in.)

Curb Mass:

VN1700A 402 kg (886 lb)

VN1700B 406 kg (895 lb)

ENGINE

Type SOHC, V-type 2-cylinder, 4-stroke, liquid-cooled

Displacement 1 700 cm³ (103.7 cu in.)

Bore x Stroke 102 × 104 mm (4.02 × 4.09 in.)

Compression Ratio 9.5 : 1

Starting System Electric starter

Cylinder Numbering Method	Front to rear, 1-2
Firing Order	2-1
Fuel System	Digital fuel injection system (DFI)
Ignition System	Battery and coil (transistorized ignition)
Ignition Timing	0° BTDC @950 r/min (rpm) ~
(Electronically advanced)	40° BTDC @3 000 r/min (rpm)
Spark Plugs	NGK ILZKAR7B11
Lubrication System	Forced lubrication (semi-dry sump)
Engine Oil:	
Type	API SG, SH, SJ, SL or SM with JASO MA, MA1 or MA2
Viscosity	SAE 10W-40
Capacity	5.0 L (5.3 US qt)
Coolant Capacity	2.4 L (2.5 US qt)

TRANSMISSION

Transmission Type	6-speed, constant mesh, return shift
Clutch Type	Wet, multi disc
Driving System	Belt

12 SPECIFICATIONS

Primary Reduction Ratio	1.515 (50/33)
Final Reduction Ratio	2.250 (72/32)
Overall Drive Ratio	2.746 @Top gear

Gear Ratio:

1st	2.933 (44/15)
2nd	1.900 (38/20)
3rd	1.407 (38/27)
4th	1.143 (32/28)
5th	0.967 (29/30)
6th	0.806 (29/36)

FRAME

Caster	30°
Trail	177 mm (7.0 in.)

Tire Size:

Front	130/90B16M/C 67H
Rear	170/70B16M/C 75H

Rim Size:

Front J16M/C × MT3.50

Rear J16M/C × MT4.50

Fuel Tank Capacity 20 L (5.3 US gal)

ELECTRICAL EQUIPMENT

Battery 12 V 18 Ah

Headlight 12 V 60/55 W

Tail/Brake Light LED

Even if one of LED (Light Emitting Diode) tail/brake lights dose not go on, consult with an authorized Kawasaki dealer.

Specifications are subject to change without notice.

14 SERIAL NUMBER LOCATIONS

Serial Number Locations

The engine and frame serial numbers are used to register the motorcycle. They are the only means of identifying your particular machine from others of the same model type. These serial numbers may be needed by your dealer when ordering parts. In the event of theft, the investigating authorities will require both numbers as well as the model type and any peculiar features of your machine that can help them identify it.

Frame No.

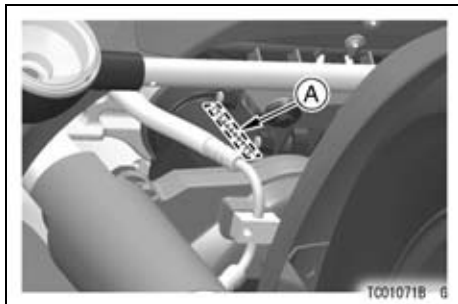

A. Frame Number

Engine No.

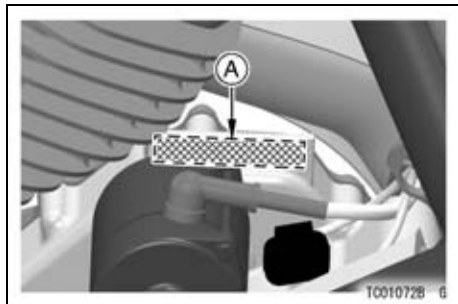

A. Engine Number

LOCATION OF PARTS

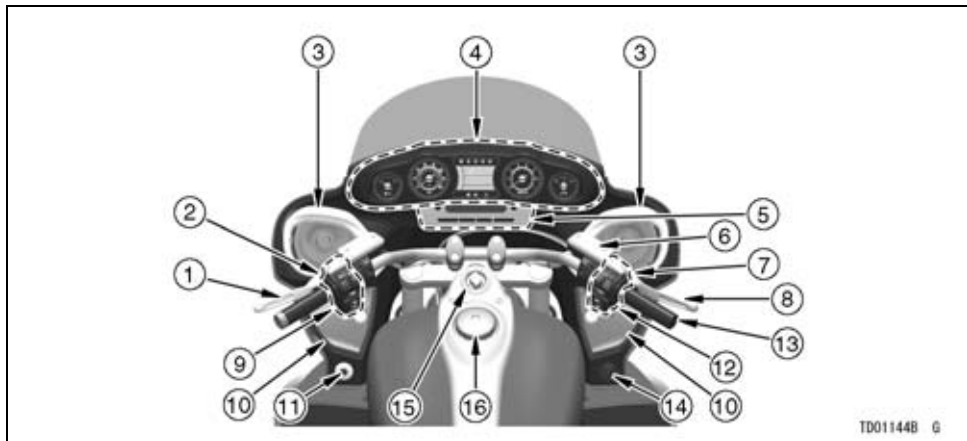

TD011448 G

1. Clutch Lever
2. Clutch Lever Adjuster
3. Front Speakers
4. Meter Unit
5. Audio Unit
6. Brake Fluid Reservoir (Front)

7. Brake Lever Adjuster
8. Front Brake Lever
9. Left Handlebar Switches
10. Fairing Pockets
11. Fog Light Switch

12. Right Handlebar Switches
13. Throttle Grip
14. Accessory Socket
15. Ignition Switch
16. Fuel Tank Cap

16 LOCATION OF PARTS

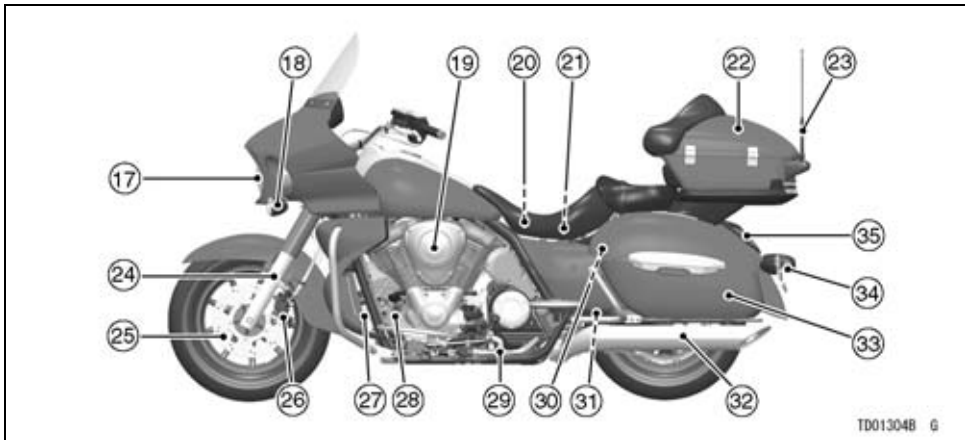

TD01304B G

17. Headlight

18. Turn Signal Light

19. Air Cleaner Element

20. Fuse Box

21. Battery

22. Travel Trunk

23. Antenna (AM/FM)

24. Front Fork

25. Brake Disc

26. Brake Caliper

27. Leg Louver

28. Shift Pedal

29. Side Stand

30. Rear Shock Absorber

31. Drive Belt

32. Muffler

33. Saddlebag

34. Licence Plate Light

35. Tail/Brake Light

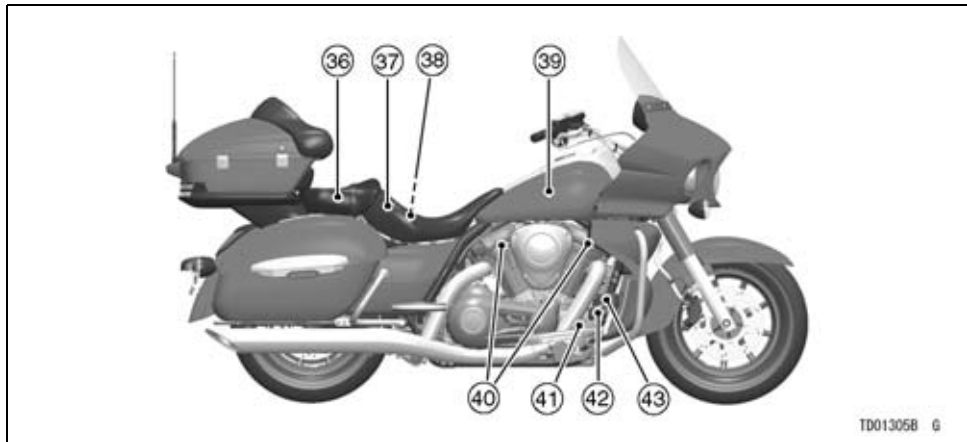

- 36. Passenger's Seat
- 37. Rider's Seat
- 38. Tool Kit
- 39. Fuel Tank

- 40. Spark Plugs
- 41. Rear Brake Light Switch
- 42. Rear Brake Pedal
- 43. Brake Fluid Reservoir (Rear)

LOADING INFORMATION

 WARNING

Incorrect loading, improper installation or use of accessories, or modification of your motorcycle may result in an unsafe riding condition. Before you ride the motorcycle, make sure it is not overloaded and that you have followed these instructions.

With the exception of genuine Kawasaki Parts and Accessories, Kawasaki has no control over the design or application of accessories. In some cases, improper installation or use of accessories, or motorcycle modification, will void the motorcycle warranty. In selecting and using accessories, and in loading the motorcycle,

you are personally responsible for your own safety and the safety of other persons involved.

NOTE

○ *Kawasaki Parts and Accessories have been specially designed for use on Kawasaki motorcycles. We strongly recommend that all parts and accessories you add to your motorcycle be genuine Kawasaki components.*

Because a motorcycle is sensitive to changes in weight and aerodynamic forces, you must take extreme care in carrying cargo, passengers and/or in fitting of additional accessories. The following general guidelines have been

prepared to assist you in making your determinations.

1. Any passenger should be thoroughly familiar with motorcycle operation. The passenger can affect control of the motorcycle by improper positioning during cornering and sudden movements. It is important that the passenger sit still while the motorcycle is in motion and not interfere with the operation of the motorcycle. Do not carry animals on your motorcycle.
2. You should instruct any passenger before riding to keep his feet on the passenger footpegs and hold on to the operator or seat strap. Do not carry a passenger unless he or she is tall enough to reach the footpegs and footpegs are provided.
3. All baggage should be carried as low as possible to reduce the effect on the motorcycle center of gravity. Baggage weight should also be distributed equally on both sides of the motorcycle. Avoid carrying baggage that extends beyond the rear of the motorcycle.
4. Baggage should be securely attached. Make sure that the baggage will not move around while you are riding. Recheck baggage security as often as possible (not while the motorcycle is in motion) and adjust as necessary.
5. Do not carry heavy or bulky items on a luggage rack. They are designed for light items, and overloading can affect handling due to changes in weight distribution and aerodynamic forces.

20 LOADING INFORMATION

6. Do not install accessories or carry baggage that impairs the performance of the motorcycle. Make sure that you have not adversely affected any lighting components, road clearance, banking capability (i.e., lean angle), control operation, wheel travel, front fork movement, or any other aspect of the motorcycle's operation.
7. Weight attached to the handlebar or front fork will increase the mass of the steering assembly and can result in an unsafe riding condition.
8. Fairings, windshields, backrests, and other large items have the capability of adversely affecting stability and handling of the motorcycle, not only because of their weight, but also due to the aerodynamic forces acting on these surfaces while the motorcycle is in operation. Poorly

designed or installed items can result in an unsafe riding condition.

9. This motorcycle was not intended to be equipped with a sidecar or to be used to tow any trailer or other vehicle. Kawasaki does not manufacture sidecars or trailers for motorcycles and cannot predict the effects of such accessories on handling or stability, but can only warn that the effects can be adverse and that Kawasaki cannot assume responsibility for the results of such unintended use of the motorcycle. Furthermore, any adverse effects on motorcycle components caused by the use of such accessories will not be remedied under warranty.

Maximum Load

Weight of rider, passenger, baggage, and accessories must not exceed 180 kg (397 lb).

GENERAL INFORMATION

Meter Instruments

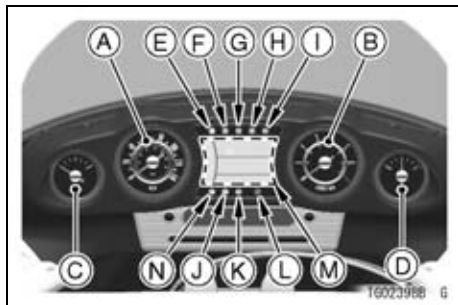

- | | |
|--|---|
| <ul style="list-style-type: none"> A. Speedometer B. Tachometer C. Fuel Level Gauge D. Coolant Temperature Gauge E. Fuel Level Warning Indicator Light F. Left Turn Signal Indicator Light G. Neutral Indicator Light H. Right Turn Signal Indicator Light I. High Beam Indicator Light | <ul style="list-style-type: none"> J. Electronic Cruise Control Indicator Light K. Electronic Cruise Control Set Indicator Light L. Warning Indicator Light M. Multifunction Meter N. K-ACT ABS Indicator Light (only on equipped model) |
|--|---|

22 GENERAL INFORMATION

Speedometer and Tachometer

The speedometer needle momentarily deflects to the far end (and then returns to the zero position) when the ignition key is turned to "ON". This checks the operation of the meter needles. So if they do not operate correctly, have the function checked by an authorized Kawasaki dealer.

The speedometer shows the speed of the vehicle.

The tachometer shows the engine speed in revolutions per minute (r/min, rpm). On the right side of the tachometer face is a portion called the "red zone." Engine r/min (rpm) in the red zone is above maximum recommended engine speed and is also above the range for good performance.

NOTICE

Engine r/min (rpm) should not be allowed to enter the red zone; operation in the red zone will overstress the engine and may cause serious engine damage.

Fuel Level Gauge

The fuel level gauge shows the amount of fuel in the fuel tank. When the needle comes near the E (empty) position, refuel at the earliest opportunity. When vehicle stands with Side Stand, Fuel Level Indicator Light/Fuel Level Gauge cannot show the amount of fuel in the fuel tank exactly. Stand upright the vehicle to check the fuel level.

NOTE

○ *If the motorcycle is held horizontal while refueling, the fuel level gauge*

may not show the rightmost needle on the gauge.

Coolant Temperature Gauge

This gauge shows the temperature of coolant. Ordinarily, the needle should stay within the white zone. If the needle reaches the red zone, stop the engine and check the coolant level in the reserve tank after the engine cools down.

NOTICE

Do not let the engine continue running when the coolant temperature gauge shows "H". Prolonged engine operation will result in severe engine damage from overheating.

Meter Unit Switch

Meter unit switch is located on the right handlebar switches. Select the

meter unit switch function by pushing the knob of the meter unit switch.

"Push the S button" means to push the knob.

"Push the MODE-A switch" means to push the knob to the left.

"Push the MODE-B switch" means to push the knob to the right.

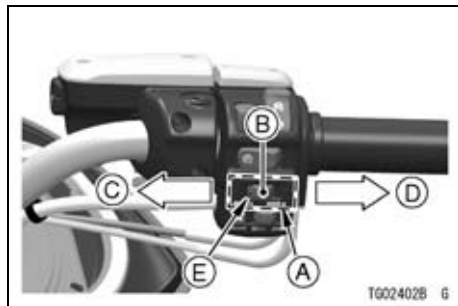

- A. Meter Unit Switch
- B. "S" Button
- C. "MODE-A" Switch
- D. "MODE-B" Switch
- E. Knob

24 GENERAL INFORMATION

Multifunction Meter

The multifunction meter displays the following functions: oil pressure warning symbol, battery warning symbol, fuel injection warning symbol, odometer, trip meters (TRIP A, TRIP B), clock, average mileage, cruising range and gear positions. When the ignition key is turned to “ON”, all the LCD segments are displayed for three seconds, then, depending on the mode selected, the clock or meters operate normally.

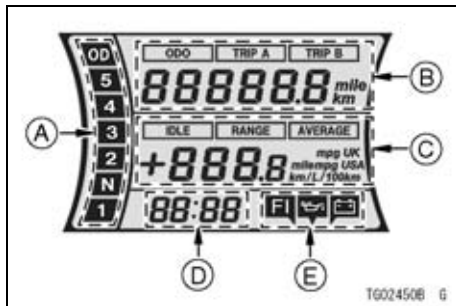

- A. Gear Position
- B. Odometer/Trip Meters (TRIP A, TRIP B)
- C. Cruising Range/Average Mileage
- D. Clock
- E. Warning Symbols Indicator

Pushing the “MODE-A” switch shifts the display in the multifunction meter through the following two modes: cruising range and average mileage.

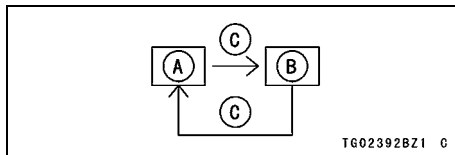

- A. Average Mileage
- B. Cruising Range
- C. Push the “MODE-A” Switch

Pushing the “MODE-B” switch shifts the display in the multifunction meter through the following three modes: odometer, trip meter A and trip meter B.

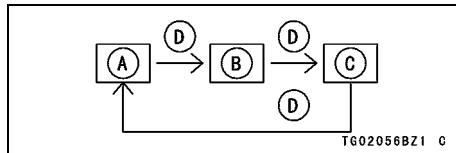

- A. Odometer (ODO)
- B. Trip Meter A (TRIP A)
- C. Trip Meter B (TRIP B)
- D. Push the “MODE-B” Switch

Odometer (ODO)-

- Push the “MODE-B” switch to display the ODO.
- The ODO shows the total distance in kilometers (km) or miles (mile) that the motorcycle has run. This meter cannot be reset.

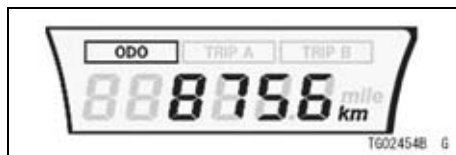

26 GENERAL INFORMATION

NOTE

- *The data are maintained even if the battery is disconnected.*
- *When the figures come to 999999, the display is locked.*
- *The measurement unit of the odometer can be changed by referring to the “Setting Menu” in this section.*

Trip Meters (TRIP A, TRIP B) –

- The trip meters show the distance in kilometers (km) or miles (mile) traveled since they were last reset to zero.

TRIP A: 0.0 ~ 9999.9

TRIP B: 0.0 ~ 999.9

- Push the “MODE-B” switch to display the TRIP A or TRIP B.



A. Trip A

B. Trip B

- Push the “MODE-B” switch to display the TRIP A or TRIP B.
- Push the “MODE-B” switch and hold it there.
- After two seconds, the display turns to 0.0 and then starts counting when the motorcycle is operated. The meter counts until it is reset.

NOTE

- *The data are maintained by the back-up power even if the ignition key is turned to “OFF”.*
- *When the trip meter display reaches 9999.9 (TRIP A) or 999.9 (TRIP B) while running, the meter is reset to 0.0 and continues counting.*
- *When the battery is disconnected, the trip meter display is reset to 0.0.*
- *The measurement unit of the trip meters can be changed by referring to the “Setting Menu” in this section.*

Gear Position Indicator-

The gear position indicator shows the corresponding gear position where the transmission is shifted.

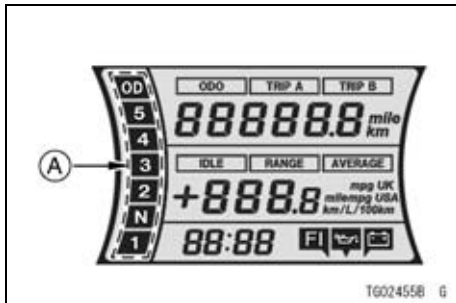
**A. Gear Position Indicator**

- 1:** When the transmission is in 1st gear, “1” is displayed.
- 2:** When the transmission is in 2nd gear, “2” is displayed.
- 3:** When the transmission is in 3rd gear, “3” is displayed.

28 GENERAL INFORMATION

- 4: When the transmission is in 4th gear, "4" is displayed.
- 5: When the transmission is in 5th gear, "5" is displayed.
- OD: When the transmission is in Over Drive gear, "OD" is displayed.

Clock -

The hour adjusting mode and minute adjusting mode can be shifted by referring to the "Setting Menu" in this section.

Average Mileage (AVERAGE)-

This display shows the average mileage by numerical value, and indicates the average fuel consumption counted from the start of measuring to the present time.

- Push the "MODE-A" switch to display the average mileage.



NOTE

- *The data are maintained by backup power even if the ignition key is turned off.*
- *The measurement unit of mileage can be changed by referring to the "Setting Menu" item in this section.*
- *Push the "MODE-A" switch for more than two seconds while the average mileage is displayed, and the average mileage is reset to "— . —".*

Cruising Range (RANGE)-

This display shows the cruising range by numerical value and indicates the cruising range from the remaining fuel in the fuel tank. This cruising range display is renewed every 10 seconds.

- Push the “MODE-A” switch to display the cruising range.



- When the fuel warning message “FUEL” flashes in the digital meter, the cruising range value also flashes “---”.

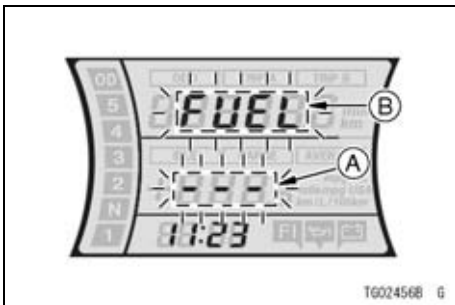

- A. “---” Flashes
- B. “FUEL” Flashes

NOTE

- *The measurement unit of the cruising range can be changed by referring to the “Setting Menu” in this section.*

30 GENERAL INFORMATION

- The display range for cruising range is 0 ~ 999.

Setting Menu

- Push the “S” button for more than two seconds.
- The clock adjusting mode, distance unit setting mode and idle adjusting mode can be shifted to, by pushing the “S” button.

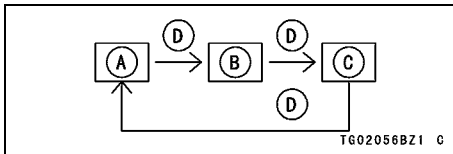

- A. Clock Adjusting Mode
- B. Distance Unit Setting Mode
- C. Idle Speed Adjusting Mode
- D. Push the “S” Button

NOTE

- Push the “S” button for more than two seconds to return to the standard display.

Clock Adjust –

- Push the “S” button to display the clock adjusting mode.
- The hour adjusting mode and minute adjusting mode can be shifted by pushing the “MODE-A” switch.

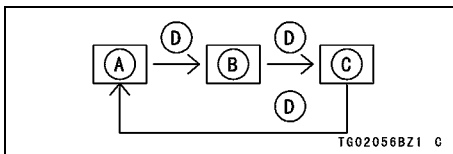

- A. No Select Mode
- B. Hour Adjusting Mode
- C. Minute Adjusting Mode
- D. Push the “MODE-A” Switch

- Pushing the “MODE-A” switch to display the hour adjusting mode. When only the hour display flashes, pushing the “MODE-B” switch to advance the hours.



- Pushing the “MODE-A” switch to display the minute adjusting mode. When only the minute display flashes, pushing the “MODE-B” switch to advance the minutes.

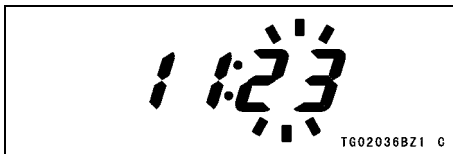

NOTE

- Pushing the “MODE-B” switch momentarily advances the hour or minute in steps. Keep pushing the switch to advance the hour or minute continuously.
- Pushing the “MODE-A” switch to display no select mode. Push the “S” button for more than two seconds for return to the standard display.

Distance Unit Set-

- Push the “S” button to display the distance unit setting mode.
- Change the distance unit of “AVERAGE” by pushing the “MODE-B” switch.
- The distance unit shifts in the following order.

32 GENERAL INFORMATION

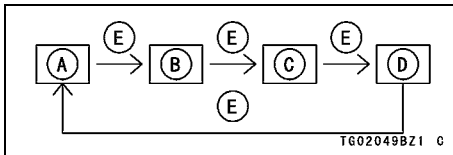

- A. km/L
- B. L/100 km
- C. mpg USA
- D. mpg UK
- E. Push the "MODE-B" Switch

NOTE

- Do not operate the motorcycle with the multifunction meter displaying in the wrong unit.
- As in the list below, "ODO", "TRIP A", "TRIP B" and "RANGE" are changed together after changing the distance unit in "AVERAGE".

AVERAGE	ODO	TRIP A	TRIP B	RANGE
km/L	km	km	km	km
L/100 km	km	km	km	km
mpg USA	mile	mile	mile	mile
mpg UK	mile	mile	mile	mile

Idle Speed Adjust-

Refer to the Idle Speed for detailed information.

Warning/Indicator Lights

: The fuel level indicator light goes on when approximately 4.0 L (1.1 US gal) of fuel remains. Refer to the Fuel Level Gauge in this chapter for more information.

 : When the turn signal switch push is pushed to the left, the left turn signal indicator light starts flashing.

N : When the transmission is in neutral position, the neutral indicator light goes on.

↷ : When the turn signal switch push is pushed to the right, the right turn signal indicator light starts flashing.

☰ : When the headlight is on high beam, the high beam indicator light goes on.

(For models equipped with K-ACT ABS)

 : The K-ACT ABS indicator light in the tachometer goes on when the ignition switch is turned on and goes off shortly after the motorcycle starts moving. If the K-ACT ABS is normal, it stays off. If something is fault with the K-ACT ABS, the indicator goes on and remains lit. You should have the

K-ACT ABS checked by an authorized Kawasaki dealer. When the K-ACT ABS indicator light is on, the K-ACT ABS does not function but if the K-ACT ABS fails, the conventional brake system will still work normally.

For more detailed information about K-ACT ABS, see the Kawasaki Advanced Coactive-braking Technology (K-ACT) Anti-lock Brake System (ABS) section in the How to Ride the Motorcycle chapter.

NOTE



- *When the K-ACT ABS indicator light is flashing, the K-ACT ABS has been in the low voltage mode (the battery voltage decreases). When it is in the low voltage mode, the K-ACT system does not function, but the ABS functions. The ignition switch is turned off to recover the K-ACT system. At this time, the battery must be in the*

34 GENERAL INFORMATION

normal condition. If the low voltage mode continues, you should have the K-ACT ABS checked by an authorized Kawasaki dealer.



Warning Indicator Light: The warning indicator light goes on and flashes when a problem occurs in the digital fuel injection/electronic throttle valve system, oil pressure, or charging system. If the warning indicator light flashes and the warning symbol is displayed, have the digital fuel injection/electronic throttle valve system checked by an authorized Kawasaki dealer.

Warning Symbol-

 : The warning indicator light under the warning symbols indicator and the oil pressure warning symbol () in the LCD digital meter both go on

whenever the oil pressure is dangerously low or the ignition switch is in the ON position with the engine not running, and they go off when the engine oil pressure is high enough. Refer to the Maintenance and Adjustment chapter for more detailed engine oil information.

FI : The warning indicator light under the warning symbols indicator and the fuel injection warning symbol (FI) in the LCD digital meter go on whenever the ignition key is turned to “ON” or trouble occurs in the fuel injection (FI) system. After turning the ignition key to “ON”, the fuel injection warning symbol (FI) goes off soon after it has been mode sure that its circuit is functioning properly. If the warning indicator light and fuel injection warning symbol (FI) stay on, have the FI system checked by an authorized Kawasaki dealer.

 : The warning indicator light under the warning symbols indicator and the battery warning symbol () in the LCD digital meter go on whenever the battery voltage is less than 10 V. The battery should be charged by using an appropriate charger, when the warning indicator light and the battery warning symbol () go on.

The warning indicator light and the battery warning symbol () still go on even after the battery is charged, ask an authorized Kawasaki dealer for an inspection.

Service Code

When a failure occurs in the digital fuel injection and electronic throttle valve system, the service code is shown on the meter, and the fuel injection warning symbol (FI) and warning indicator light blink or light. If the service code and warning indicator light are shown on the meter, ask an authorized Kawasaki dealer for repair.

36 GENERAL INFORMATION

Keys

This motorcycle has a combination key, which is used for the ignition switch, steering lock, and fuel tank cap. Included with the key is a key number, which is stamped on the tag. Record the key number in the space provided and store the number in a safe place. If your keys came with a tag, store it in a safe place as well.

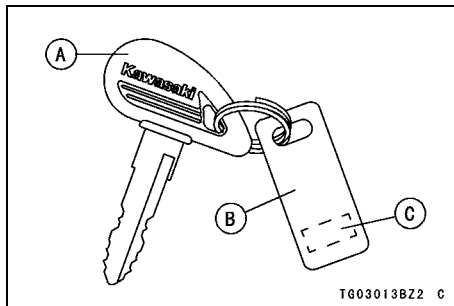

- A. Ignition Key
- B. Tag
- C. Key Number

Write your key number here.

In the event you lose your keys, you will need the key number to have a duplicate made. If you cannot locate your key number, contact the dealer where you purchased your Kawasaki motorcycle. It's possible the dealer may have the number in its records. If the key number is lost completely, you will need to replace the ignition switch and all other locks operated by that key.

Contact your Kawasaki dealer to purchase additional spare keys either using your original key as a master or using the key code on the tag or your key. Store one key at home and keep another spare in your wallet or riding gear, in case the original is lost.

Ignition Switch/Steering Lock

This is a four-position, key-operated switch. The key can be removed from the switch in three position (LOCK, OFF, ON).

Remove the ignition key from the ignition switch before riding if you want to reduce the chance of the key chain damaging the finish of your motorcycle.

38 GENERAL INFORMATION

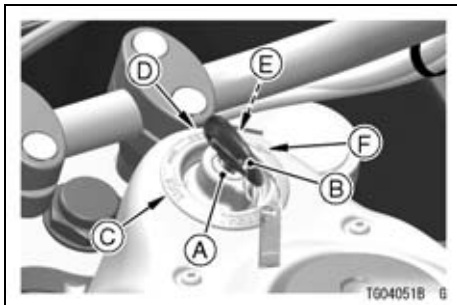

- A. Ignition Switch
- B. Ignition Key
- C. LOCK Position
- D. OFF Position
- E. ACC Position
- F. ON Position

- Turn the handlebar fully to the left for locking the steering lock.
- The LOCK position and OFF position can be shifted to, by push down and turn on the ignition key.

LOCK	Steering locked. Engine off. All electrical circuits off.
OFF	Engine off. All electrical circuits off.
ACC	Engine off. Audio system, accessory socket, accessory connector, fog light, hazard light equipment can be used.
ON	Engine on. All electrical equipment can be used.

NOTE

- *The tail, city and license plate lights are on whenever the ignition switch is in the ON position. The headlight goes on when the starter button is released after starting the engine. To avoid battery discharge, always start the engine immediately after turning the ignition key to ON.*

- *If you leave the ON position on for a long time, the battery may become totally discharged.*

To operate the ignition Switch:

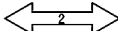
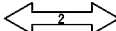
OFF  ACC  ON



1. Turn the handlebar fully to the left.
2. Turn the key.
3. For locking push down the key in the OFF position and turn it to LOCK.

LOCK

Audio System

Important Notice

Some states prohibit the wearing of “headphones” or “headsets” while operating a motor vehicle. While mounting audio speakers in motorcycle helmets does not convert them to “headphones” or “headsets”, some states may still prohibit the use of this helmet sound system under other statutes. Kawasaki advises you to determine the legality of this helmet sound system prior to using it in any state.

Operating Precautions

There are a number of important precautions that must be heeded when operating the audio system. Learn and observe all of the following rules.

 **WARNING**

Removing your hand(s) from the handlebar while riding could result in an accident resulting in serious injury or death. Do not remove your hand(s) from the handlebar to adjust the audio system controls. Make any adjustments before riding or stop to make adjustments. Operating the audio system at loud volumes can interfere with your ability to hear sirens, horns, or other warning signals and lead to an accident resulting in serious injury or death. Do not operate the audio system at volumes so loud that they interfere with your ability to hear sirens, horns, or other warning signals. Do not operate the audio system at volumes so loud that it disturbs other people. Aftermarket accessories that are not Kawasaki Genuine Accessories may adversely affect handling or vehicle performance. Since Kawasaki Genuine Accessories have been specially designed for use on Kawasaki motorcycles and Kawasaki has no control over the design or application of other aftermarket accessories, it is strongly recommended that all parts and accessories you add to your motorcycle be Kawasaki Genuine Accessory components.

NOTICE

Do not use any substitute for the standard fuse. If a fuse is blown, inspect the electrical system to determine the cause and then replace it with a new one of the correct capacity. The audio system is designed for use with a 12 V DC negative ground system. Do not use the audio system with other voltages or a positive ground system.

If you use the audio system for a long time with the engine stopped, the battery may become discharged. When you use the audio system with the engine stopped, decrease the volume as far as possible. Increasing the volume increases the power consumption.

When the ignition switch is turned OFF, the preset memory will continue to function with the back-up power supply circuit from the battery.

Avoid spraying water with great force near the audio components.

To prevent surface damage, do not clean plastic parts with organic solutions such as gasoline, thinner or benzine. Use a soft cloth which has been soaked in a solution of neutral detergent to clean plastic parts, then dry them with a soft cloth.

The Kawasaki Audio System includes the following features:

- FM/AM/WX band radio
- Automatic volume control (AVC)
- Auxiliary input (AUX) for a portable audio device (optional)
- Apple iPod® integration (optional)
- Rider/passenger intercom with voice activation (VOX) (optional)
- CB radio (optional)
- XM® satellite radio (optional)

 **WARNING**

Failure to read to the Operating Precautions before operating the audio system may lead to a system malfunction and/or damage to the unit. Carefully read the Operating Precautions section before operating the audio system. Learn and observe all rules.

Parts Name

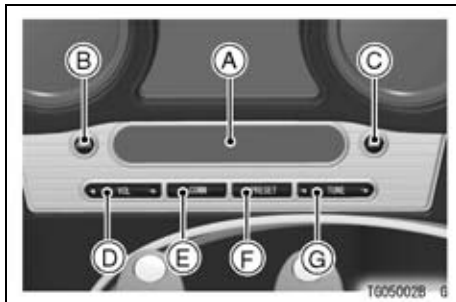

- A. LCD (Liquid Crystal Display)
- B. POWER Button
- C. MODE Button
- D. ◀VOL▶ Button
- E. COMM Button
- F. PRESET Button
- G. ◀TUNE▶ Button

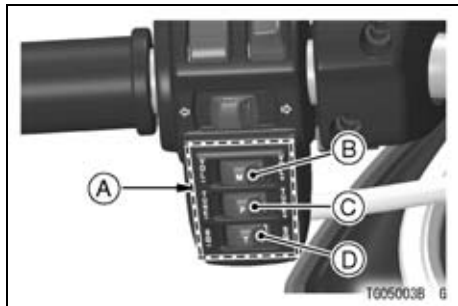

- A. Left Handlebar Switches
- B. VOL +/- Switch and M Button
- C. TUNE +/- Switch and P Button
- D. SQ +/- Switch and T Button

“M” (Mode), “P” (Preset) and “T” (Talk) buttons carry out a function when pushed.

Getting Started

The motorcycle ignition switch must be in the ON or ACC position to use the audio system.

Radio Power On/Off

When the ignition switch is turned on to the ON or ACC position, the display will show the “Kawasaki” logo during initialization and then the current mode of the system.

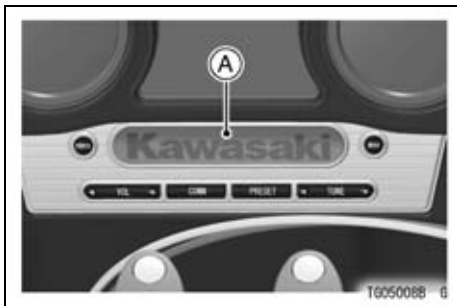

A. Kawasaki Logo

- Push the “POWER” button to turn on the radio.

- Push the “POWER” button to turn off the radio. The backlight will remain illuminated and display the “Kawasaki” logo until the ignition is turned off.

NOTE

- *Turning off the ignition switch will automatically turn off the radio.*

Radio (FM/AM/WX BAND)

Volume Adjustment

- Push the “◀VOL▶” button on the dashboard or the “VOL +/-” switch in the left handlebar switch to adjust volume from 0 to 30. You can push and hold the switch to quickly adjust system volume up or down.

46 GENERAL INFORMATION

- Push the “◀VOL▶” button on the dashboard or the “VOL +/-” switch in the left handlebar switch for more than 1 second to increase or decrease volume level continuously.

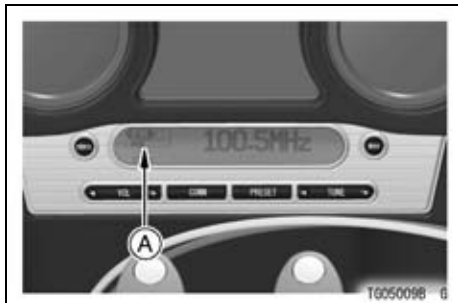

A. Volume Level

Source Change

- Push and release the “MODE” button on the dashboard or “M” button in the left handlebar switch to toggle between FM, AM, WX, AUX or iPod and XM (if equipped) sources.

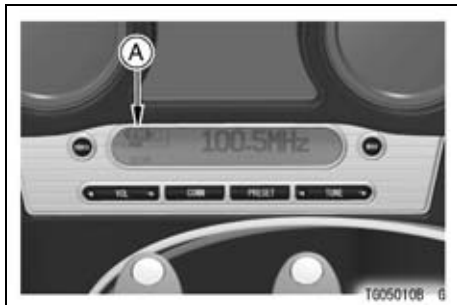

A. Radio Band

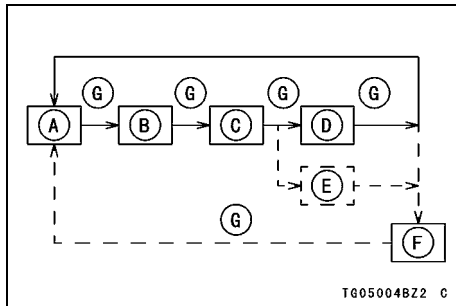

- A. FM
- B. AM
- C. WX
- D. AUX
- E. iPod (If iPod cable is installed and iPod is present.)
- F. XM (Optional XM will only appear in loop if connected to system.)
- G. Push “MODE” button or “M” button

When the band is changed, the station that was selected before the change is selected.

AUX Operation Specification

The iPod and audio apparatus can be connected to listen to music.

- Push the “MODE” button on the dashboard or “M” button in the left handlebar switch to change to “AUX” mode.

NOTE

- *The sound system will include AUX as an available entertainment source even if no device is present.*
- *The connection with audio apparatus is only audio signal.*

Manual Tuning

- Push and release the “◀TUNE▶” button on the dashboard or the “TUNE +/-” switch in the left handlebar switch to manually change stations.



A. Radio Station Frequency

Seek Tuning

- Push and hold the “◀TUNE▶” button on the dashboard or the “TUNE +/-” switch in the left handlebar switch until the audio stops. When you release the switch, the radio will seek the next strong station.

- Seeking is stopped when the “PRE-SET” button on the dashboard or “P” button in the left handlebar switch is pushed during seek tuning.

Preset Stations

12 AM and 12 FM stations can be preset in memory and channel 1 through 12 is displayed.

NOTE

- *Only positions that have stored preset stations are displayed – if there are only three preset stations stored, only three preset numbers will be displayed.*

No station is preset at initial power on.

the preset number that you want to store.



A. Preset Channel Number

Storing Presets

- Tune to the desired station.
- Push and hold the “PRESET” button on the dashboard or “P” button in the left handlebar switch until “Preset Store” is displayed.
- Push the “◀TUNE▶” button on the dashboard or the “TUNE +/-” switch in the left handlebar switch to select

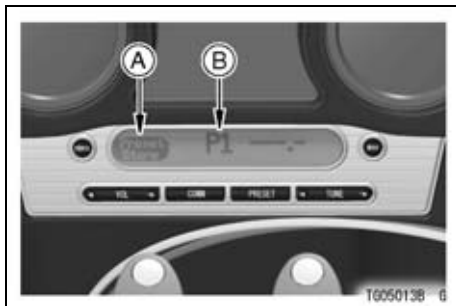

**A. “Preset Store” Mode
B. Channel Number**

- Push the “PRESET” button on the dashboard or “P” button in the left handlebar switch for less than 0.5 second to store the frequency and the number is displayed beside band indicator.

NOTE

- *Storing a station in a preset will erase any previously stored information in that preset.*

Recalling Presets

- To recall the preset stations, push and release the “PRESET” button on the dashboard or “P” button in the left handlebar switch. The radio will advance to the next stored station each time the “PRESET” button on the dashboard or “P” button in the left handlebar switch is pushed.

NOTE

- *The preset station recall cannot be performed during seek tuning.*
- To clear the preset, see Clear Presets (“Tuner Setup” Mode).

Audio Adjustments

Bass, Mid and Treble can be adjusted to match your listening preferences.

- Push and hold the “MODE” button on the dashboard or “M” button in the left handlebar switch until the display indicates “Audio Setup” mode.

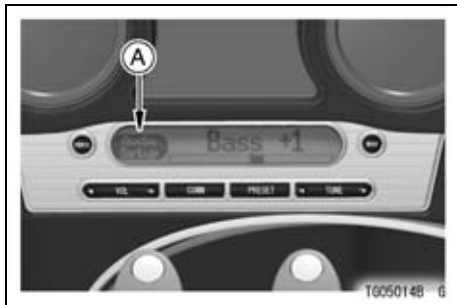

A. “Audio Setup” Mode

- When pushing the “MODE” button on the dashboard or “M” button in the left handlebar switch within 5 seconds, the display changes as follows.
- The display will return to normal after 5 seconds with no additional switch pushes or turns required.

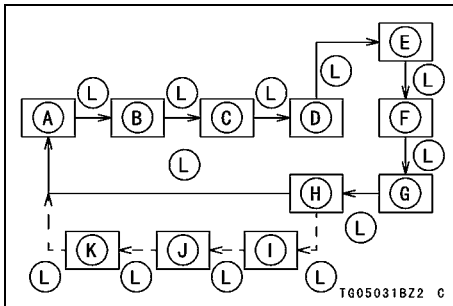

- A. Bass
- B. Mid
- C. Treble
- D. Fade (Fader)
- E. Spkr (Speaker)
- F. AVC (Automatic Volume Control)
- G. Clear Presets ("Tuner Setup" Mode)
- H. RDS (Radio Data System, "Tuner Setup" Mode)
- I. XM Preset Setup (Only available when XM module is present.)
- J. XM Display Mode (Only available when XM module is present.)
- K. XM Category Setup (Only available when XM module is present.)
- L. Push "MODE" or "M" button

Bass

- Use the "MODE" button on the dashboard or "M" button in the left handlebar switch to find the "Bass" mode and push the "◀VOL▶" button on the dashboard or the "VOL +/-" switch in the left handlebar switch to change the setting from -7 to +7.



A. Bass Mode

Mid

- Use the “MODE” button on the dashboard or “M” button in the left handlebar switch to find the “Mid” mode and push the “◀VOL▶” button on the dashboard or the “VOL +/-” switch in the left handlebar switch to change the setting from -7 to +7.



A. Mid Mode

Treble

- Use the “MODE” button on the dashboard or “M” button in the left handlebar switch to find the “Treble” mode and push the “◀VOL▶” button on the dashboard or the “VOL +/-” switch in the left handlebar switch to change the setting from -7 to +7.



A. Treble Mode

Fade (Fader)

The “Fade” mode indicates the volume balance of the front and rear speakers. The rear speakers are optional parts.

- Use the “MODE” button on the dashboard or “M” button in the left handlebar switch to find the “Fade” mode and push the “VOL▶” (up) button on the dashboard or the “VOL +” (up) switch in the left handlebar switch to shift the volume from the rear speaker to the front speaker.
- Push the “◀VOL” (down) button on the dashboard or the “VOL –” (down) switch in the left handlebar switch to shift the volume from the front speaker to the rear speaker.

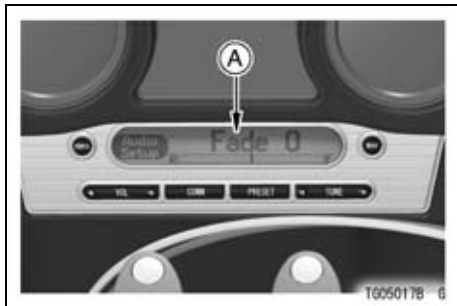

A. Fade Mode

Spkrs (Speakers)

The “Spkrs” mode indicates the function of the speakers.

- Use the “MODE” button on the dashboard or “M” button in the left handlebar switch to find the “Spkrs” mode and push the “◀VOL▶” button on the dashboard or the “VOL +/-” switch in the left handlebar switch to change the speakers ON or OFF.



A. Spkrs Mode

AVC (Automatic Volume Control)

The AVC feature automatically adjusts the radio volume based on the speed of your motorcycle. The radio's default setting has AVC activated. You can adjust the aggressiveness of the AVC or deactivate this feature completely.

- Use the “MODE” button on the dashboard or “M” button in the left handlebar switch to find the “AVC” mode and push the “◀VOL▶” button on the dashboard or the “VOL +/-” switch in the left handlebar switch to change the setting from 0 (OFF) to 5.



A. AVC Mode

NOTE

- *The AVC setting of 1 is the least aggressive and is also the radio default setting. We suggest riding with this setting first before making any adjustments. A rider with an open face helmet may prefer a more aggressive volume increase as compared to a rider with a full-face helmet.*

Clear Presets (“Tuner Setup” Mode)

All preset memories can be erased at the “Clear Presets” mode.

- Select the band (FM or AM) to clear.
- Use the “MODE” button on the dashboard or “M” button in the left handlebar switch to find the “Clear Presets” mode and push the “◀VOL▶” button on the dashboard or the “VOL +/-” switch in the left handlebar switch to select the band (FM or AM). Push the “PRESET” button on the dashboard or “P” button in the left handlebar switch to erase the preset memories.

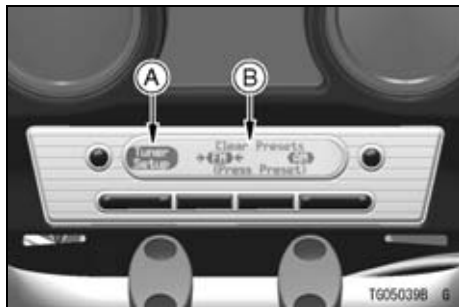

A. Tuner Setup Mode
B. Clear Presets Mode

RDS (Radio Data System)

The FM radio is equipped with RDS. Some FM radio stations transmit data such as station name and song/artist name. When this data is available, it will be displayed.

- To enable or disable RDS, use the “MODE” button on the dashboard or

“M” button in the left handlebar switch to find the “RDS” mode and push the “◀VOL▶” button on the dashboard or the “VOL +/-” switch in the left handlebar switch to change the “RDS” ON or OFF.

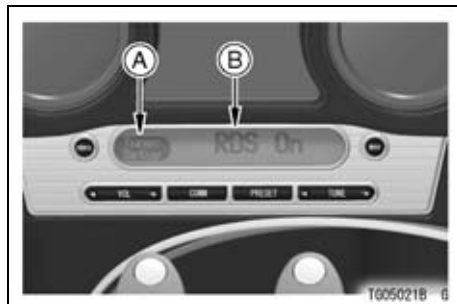

A. Tuner Setup Mode
B. RDS Mode

58 GENERAL INFORMATION

Country Indication

- When showing the “Kawasaki” logo in the display, push and hold the “POWER” button on the dashboard for about 2 seconds.
- The display will show the country that was setting already.
- The display will return to the “Kawasaki” logo after 5 seconds or pushing the “POWER” button within 5 seconds.

Country Setting Mode

- The country setting is changed in the “Tuner Location” mode.
- Set the “Tuner Location” mode according to the following procedures.
- When the ignition switch is in the ON or ACC position, push the “POWER” button on the dashboard to turn the audio system off.

- Turn the ignition switch OFF and then turn the ignition switch to ON or ACC. The display will show the “Kawasaki” logo.
- Push the “PRESET” button and the “POWER” button on the dashboard at the same time. The version of the microcomputer is displayed.



A. Version Information

- In this mode, push the “MODE” button on the dashboard to change as the following mode.

60 GENERAL INFORMATION

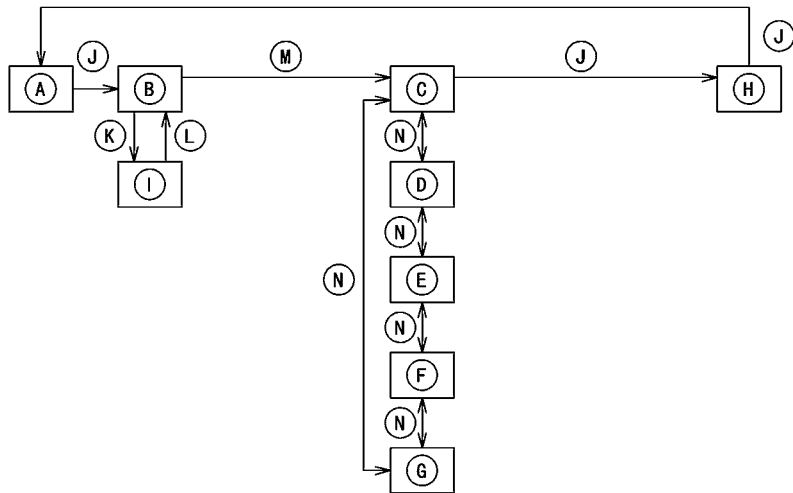

- A. Version Information
- B. No Display
- C. North America
- D. Europe
- E. Japan
- F. Australia
- G. Taiwan
- H. Speed
- I. Name of Button Pushed
- J. Push "MODE" Button or "M" Button
- K. Push and Hold Any Button except "MODE"
Button
- L. Release Any Button Pushed
- M. Push "MODE" Button
- N. Push "◀TUNE▶" Button

62 GENERAL INFORMATION

- If you want to change the country, set the “Tuner Location” mode and push the “◀TUNE▶” button on the dashboard to select the country.
- To fix the country, push the “POWER” button on the dashboard.
- To exit the diagnosis mode, push the “POWER” button on the dashboard.

iPod Integration

The optional iPod harness allows an iPod to be controlled through the audio system. The display will show songs and artist information from your iPod and allow you to select songs and playlists. The iPod battery is charged whenever the audio system has power.

NOTE

- *Only one media player can be connected to the sound system. This means that you will be able to use either an iPod or a portable media device, but not both at the same time.*
- *Kawasaki is not responsible for any damage to iPod or other media player due to storage in the fairing pocket.*

COMM Button

By pushing this button, the audio system can enter the intercom (ON/OFF), VOX (adjustment) and CB (Accessory) modes.

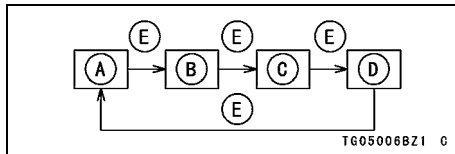

- A. ICOM Mode
- B. VOX Level Mode
- C. CB Mode (Only available when CB module is present.)
- D. CB Channel Mode (Only available when CB module is present.)
- E. Push “COMM” button.

Intercom (Accessory Parts)

The intercom that allows the rider and passenger to communicate while riding is available as an accessory part.

- Push the “COMM” button on the dashboard to enter the “Icom” (Intercom) mode.
- Push the “◀TUNE▶” button on the dashboard or the “TUNE +/-” switch in the left handlebar switch to select ON or OFF of the intercom.

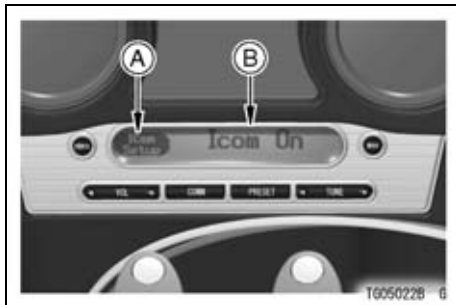

- A. ICom Setup Mode
- B. Icom (On/Off) Mode

- Push the “COMM” button on the dashboard to enter the “VOX” (Voice Activation) mode.
- Push the “◀TUNE▶” button on the dashboard or the “TUNE +/-” switch in the left handlebar switch to change the VOX sensitivity setting from 0 (Vox Open) to 30 (Vox Closed).

64 GENERAL INFORMATION



A. Vox Mode

NOTE

- When the system is in the "Icom Off" mode, it does not enter the "VOX" mode.

Antenna Removal

- Turn the lower end of the antenna counterclockwise and remove it from the motorcycle.

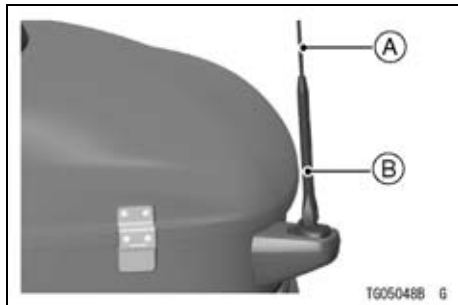

A. Antenna
B. Antenna Grip

Antenna Installation

- Grasp the antenna grip and tighten in clockwise on the holder so that it will not loosen while you are riding.

XM RADIO TUNER (Accessory Part)

The Audio System fully integrates an XM satellite radio accessory. The system treats XM like another audio source. The XM radio tuner will automatically be turned on when the audio system is powered up. Push the “MODE” button on the dashboard or “M” button on the handlebar to cycle through audio sources.

CB (Citizen's Band) RADIO (Accessory Part)**NOTE**

- *This CB radio has been approved by the Federal Communications Commission (F.C.C.) and has the “type acceptance” labels on it.*

 WARNING

Failure to read to the Operating Precautions before operating the CB radio may lead to a system malfunction and/or damage to the unit. Carefully read the Operating Precautions section before operating the CB radio. Learn and observe all rules.

The Audio System supports Kawasaki's 40-channel CB radio accessory. The CB option enables communication with other riders or vehicles that are equipped with CB radios.

- To activate the CB radio, push the “COMM” button on the dashboard to enter the COMM adjustment screens. Continue to push and release the COMM button until the CB on/off screen is accessed. Use the “◀TUNE▶” button on the dashboard

66 GENERAL INFORMATION

or “TUNE +/-” switch in the left handlebar switch to turn the CB ON or OFF.

CB Channel

Push the “COMM” button on the dashboard until you see CB channel in the display, then push the “◀TUNE▶” button on the dashboard or the “TUNE +/-” switch in the left handlebar switch to select the desired CB channel.

PTT (Push to Talk)

To transmit using the CB, push and hold the “T” button in the left handlebar switch. Speak into the microphone and release the “T” button to end the transmission.

Squelch

The CB squelch setting is used to determine the signal strength required to activate the CB receiver and interrupt

the entertainment audio. If the squelch setting is too low, weak transmissions or static may constantly interrupt your audio. If the squelch setting is very high, you may only hear very strong transmissions.

- To adjust squelch, push the “SQ +/-” switch in the left handlebar switch to adjust the squelch setting from 1 (OPEN or always receiving) to 30 (CLOSED or not receiving).

NOTE

- *If you are riding in a group or close to the people you are communicating with, a higher squelch setting will help reduce interruptions. If you are communicating with someone farther away, you may need to reduce squelch to a lower setting to keep receiving their transmission.*

CB Volume

CB volume setting is independent of the entertainment and intercom volume settings. Each feature needs to be adjusted individually.

- To adjust CB volume, push the “◀VOL▶” button on the dashboard or the “VOL +/-” switch in the left handlebar switch while CB squelch is broken (i.e. CB is receiving a transmission).

NOTE

- *CB audio is only in the headset. The passenger can control CB volume independently.*

Left Handlebar Switches

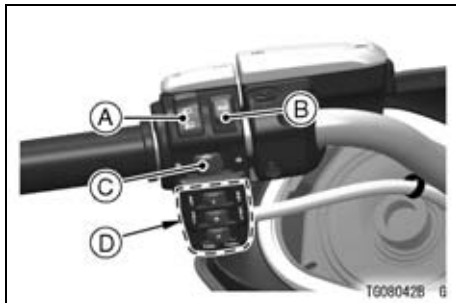

- A. Dimmer Switch
- B. Horn Button
- C. Turn Signal Switch
- D. Audio Control Switches



Dimmer Switch



High or low beam can be selected with the dimmer switch. When the headlight is on high beam (), the high beam indicator light goes on.

High beam.....()

Low beam.....()

Turn Signal Switch

When the turn signal switch is pushed to the left () or right (), the corresponding turn signals flash on and off.

When the turn signal is on the left () or right (), the left turn signal indicator light and right turn signal indicator light is flash.

The turn signal switch is automatically canceled after it has first been on for 8 seconds, and then the motorcycle has traveled an additional 65 m (213 ft). However, make a practice of pushing the switch in to stop flashing.

Horn Button

When the horn button is pushed, the horn sounds.

Audio Control Switches

Refer to the Audio System for detailed information.

Right Handlebar Switches

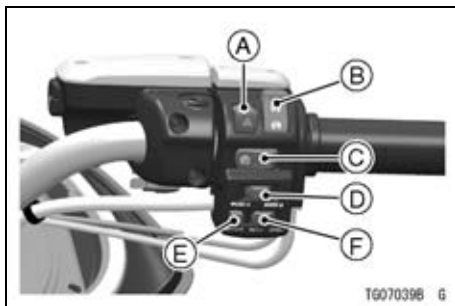

A. Hazard Switch

B. Engine Stop Switch

C. Starter Button

D. Meter Unit Switch

E. Electronic Cruise Control ON/OFF Button

F. Electronic Cruise Control Switch (SET/- and RES/+)

Hazard Switch

If an emergency requires you to park on the highway shoulder, turn on the hazard lights to warn other drivers of your location.

Push in the hazard switch with the ignition switch in the ON and ACC positions. All the turn signals and turn signal indicator lights will flash on and off.

NOTICE

Be careful not to use the hazard lights for more than 30 minutes, otherwise the battery may become totally discharged.

Engine Stop Switch

In addition to the ignition switch, the engine stop switch must be in the  position for the motorcycle to operate.

The engine stop switch is for emergency use. If some emergency requires stopping the engine, move the engine stop switch to the  position.

NOTE

- *Although the engine stop switch stops the engine, it does not turn off all the electrical circuits. Ordinarily, the ignition switch should be used to stop the engine.*

Starter Button

The starter button operates the electric starter when the transmission is in neutral.

Refer to the Starting the Engine section of the "How to Ride the Motorcycle" chapter for starting instructions.

Meter Unit Switch

Refer to the Meter Instruments in this chapter.

Electronic Cruise Control ON/OFF Button

Refer to the Electronic Cruise Control System for detailed information.

Electronic Cruise Control Switch (SET/- and RES/+)

Refer to the Electronic Cruise Control System for detailed information.

Electronic Cruise Control System

This motorcycle is equipped with Electronic Cruise Control system which is designed to maintain any speed between 48 ~ 137 km/h (30 ~ 85 mph) in the 3rd, 4th, 5th or OD (6th) gear position. Use the Electronic Cruise Control system on straight, uncongested roads or high-ways.

 **WARNING**

The Electronic Cruise Control system automatically maintains a set vehicle speed that may not be appropriate in rapidly changing traffic situations, on hills or on winding roads and could cause an accident resulting in serious injury or death. Do not use the Electronic Cruise Control system when riding in heavy or varying traffic, on hills or when negotiating winding roads.

NOTE

- *When operating on public roadways, keep max. speed under traffic law limits.*

Electronic Cruise Control Indicator Light

When the electronic cruise control ON/OFF button is pushed on, the electronic cruise control indicator light on the meter goes on.

Electronic Cruise Control Set Indicator Light

When the motorcycle is running at a set speed, the electronic cruise control set indicator light on the meter goes on.

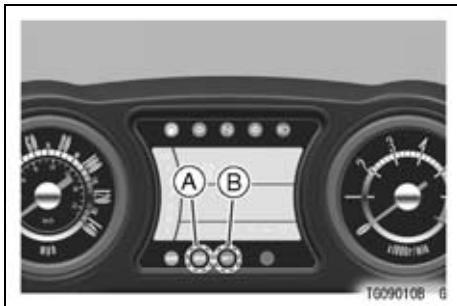

- A. Electronic Cruise Control Indicator Light
- B. Electronic Cruise Control Set Indicator Light

Electronic Cruise Control Switch (SET/- and RES/+)

This switch has two positions: “RES/+” switch and “SET/-” switch. These switch functions allow a cruising speed to be set or changed.

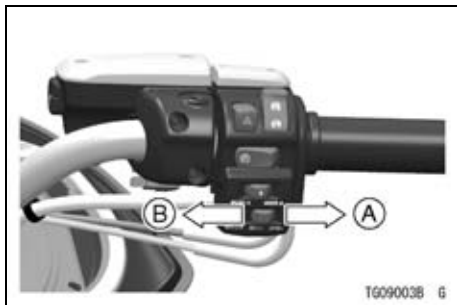

- A. “RES/+” Switch
- B. “SET/-” Switch

To Set the Electronic Cruise Control

- Push the electronic cruise control ON/OFF button.
- The electronic cruise control indicator light on the meter will go on.

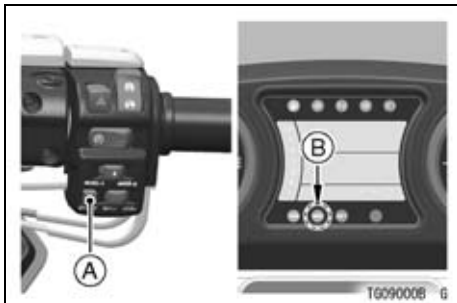

- A. Electronic Cruise Control ON/OFF Button**
B. Electronic Cruise Control Indicator Light

- Accelerate to the desired speed.
- Push the “SET/-” switch.

- The electronic cruise control set indicator light on the meter will go on.

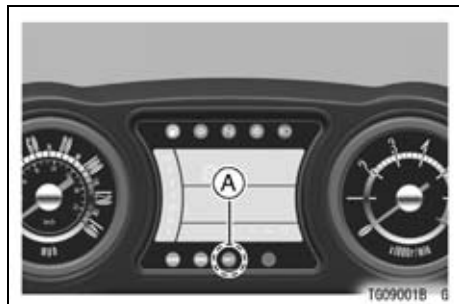
**A. Electronic Cruise Control Set Indicator Light**

- The speed you are going when you release the “SET/-” switch is the speed the electronic cruise control will hold.

74 GENERAL INFORMATION

NOTE

- *When running on a rough road under the electronic cruise control, the motorcycle may be slightly above or below the set speed.*

To Increase the set speed

- For gradual acceleration, push and hold the “RES/+” switch until you reach the desired speed, and then release the switch. The Electronic Cruise Control system memory is now reprogrammed to the new set speed.

NOTE

- *The set speed increases by 1.6 km/h (1 mph) with each tap the “RES/+” switch.*

- For faster acceleration, operate the throttle grip until you reach the desired speed, push the “SET/-” switch and then release it.

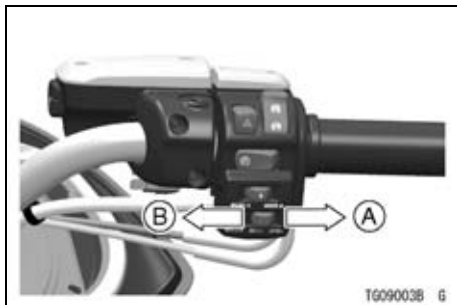

- A. “RES/+” Switch
- B. “SET/-” Switch

NOTE

- *When running at speed above 137 km/h (85 mph), you cannot set the speed above 137 km/h (85 mph) by using the “SET/-” switch.*

To Decrease the set speed

- Push and hold the “SET/-” switch until you slow down enough, and then release the switch. The Electronic Cruise Control system memory is now reprogrammed to the new set speed.

NOTE

- *The set speed decreases by 1.6 km/h (1 mph) with each tap the “SET/-” switch.*
- For temporary acceleration above the set speed, such as for passing, use the throttle conventionally.

When you want to return to the set speed, close the throttle and coast down without applying the front or rear brakes.

NOTE

- *When pulling the brake lever or stepping on the brake pedal, the electronic cruise control system is canceled.*

To Cancel the Electronic Cruise Control

- Push the electronic cruise control ON/OFF button.

76 GENERAL INFORMATION

- The electronic cruise control set indicator light and the electronic cruise control indicator light on the meter will go off (this also erases the memory of the set speed).

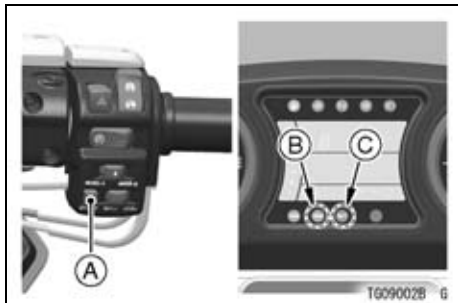

- A. Electronic Cruise Control ON/OFF Button
- B. Electronic Cruise Control Indicator Light
- C. Electronic Cruise Control Set Indicator Light

NOTE

- *When the vehicle speed is below 48 km/h (30 mph), the Electronic Cruise Control is cancelled (this also erases the memory of the set speed).*
- If you must temporarily disengage the system (but want to remain the memory of the set speed):
 - Pull the brake lever.
 - Pull the clutch lever.
 - Step lightly on the brake pedal.
 - Close the throttle more beyond the throttle position where it returns back by the return spring.
 - Shift gears.

NOTE

- *The system is not disengaged when shifting change without using the clutch.*

- *When the system is disengaged temporarily, the electronic cruise control set indicator light goes off, while the electronic cruise control indicator light stays on.*
- If you are still going in the working condition, you can resume the set speed by simply pushing the “RES/+” switch.
- The electronic cruise control set indicator light on the meter goes on again.

Brake Lever and Clutch Lever Adjusters

The distance between the lever and grip can be adjusted by the adjusters of the brake lever and clutch lever. Push the lever forward and turn the adjuster so that the projection of the lever aligns with the wider groove on the outer edge of the adjuster.

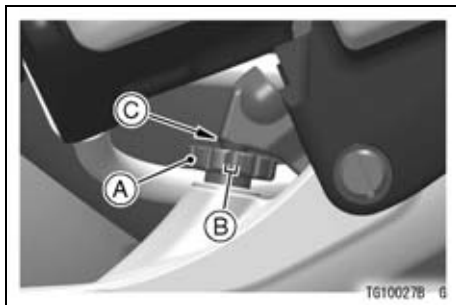

- A. Brake Lever Adjuster
- B. Wider Groove
- C. Projection

78 GENERAL INFORMATION

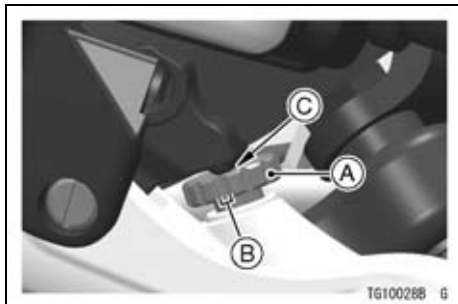

- A. Clutch Lever Adjuster
- B. Wider Groove
- C. Projection

Fog Light Switch

- Fog light switch is located the under the left faring pocket.
- Light the fog light by pushing the fog light switch.

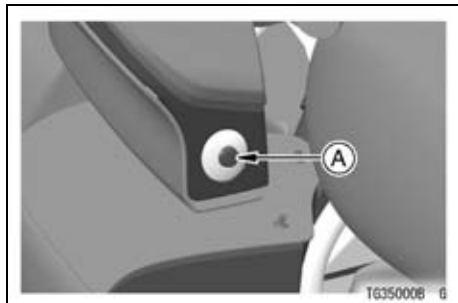

- A. Fog Light Switch

Fuel Tank Cap

To open the fuel tank cap, insert the ignition key into the fuel tank cap and turn the key to the clockwise.

To close the cap, push it down into place with the key inserted. The key can be removed by turning it to the left to the original position.

NOTE

- *The fuel tank cap cannot be closed without the key inserted, and the key cannot be removed unless the cap is locked properly.*
- *Do not push on the key to close the cap or the cap cannot be locked.*

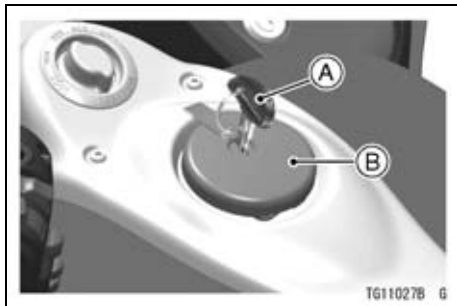

- A. Ignition Key
- B. Fuel Tank Cap

Fuel Tank

The following octane rating gasoline is recommended in the fuel tank.

Avoid filling the tank in the rain or where heavy dust is blowing so that the fuel does not get contaminated.

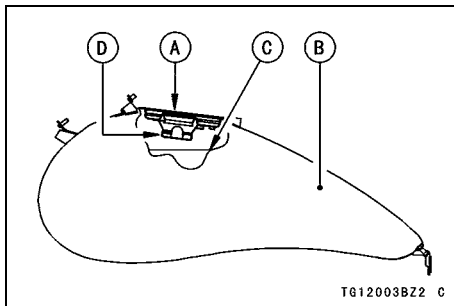

- A. Tank Cap
- B. Fuel Tank
- C. Top Level
- D. Filler Neck

⚠ WARNING

Gasoline is extremely flammable and can be explosive under certain conditions, creating the potential for serious burns. Turn the ignition switch to "OFF". Do not smoke. Make sure the area is well-ventilated and free from any source of flame or sparks; this includes any appliance with a pilot light. Never fill the tank completely to the top. If the tank is filled completely to the top, heat may cause the fuel to expand and overflow through the vents in the tank cap. After refueling, make sure the tank cap is closed securely. If gasoline is spilled on the fuel tank, wipe it off immediately.

NOTICE

California models only: Never fill the tank so the fuel level rises into the filler neck. If the tank is overfilled, heat may cause the fuel to expand and flow into the Evaporative Emission Control System resulting in hard starting and engine hesitation and in compliance with the emission regulation.

Fuel Requirement*Fuel Type*

Use clean, fresh unleaded gasoline with a minimum Antiknock Index of 90. The Antiknock Index is posted on service station pumps. The octane rating

of a gasoline is a measure of its resistance to detonation or “knocking.” The Antiknock Index is an average of the Research Octane Number (RON) and the Motor Octane Number (MON) as shown in the table.

Octane Rating Method	Minimum Rating
Antiknock Index $\frac{(\text{RON} + \text{MON})}{2}$	90

NOTICE

Use minimum of 90 octane gasoline only to prevent severe engine damage.

NOTICE

If engine “knocking” or “pinging” occurs, use a different brand of gasoline of a higher octane rating. If this condition is allowed to continue it can lead to severe engine damage.

Gasoline quality is important. Fuels of low quality or not meeting standard industry specifications may result in unsatisfactory performance. Operating problems that result from the use of poor quality or nonrecommended fuel may not be covered under your warranty.

Fuels Containing Oxygenates

Gasoline frequently contains oxygenates (alcohols and ethers) especially in areas of the U.S. and Canada which are required to sell such reformulated fuels as part of a strategy to reduce exhaust emissions.

The types and volume of fuel oxygenates approved for use in unleaded gasoline by the U.S. Environmental Protection Agency include a broad range of alcohols and ethers, but only two components have seen any significant level of commercial use.

Gasoline/Alcohol Blends - Gasoline containing up to 10% ethanol (alcohol produced from agricultural products such as corn), also known as “gasohol” is approved for use.

NOTICE

Avoid using blends of unleaded gasoline and methanol (wood alcohol) whenever possible, and never use “gasohol” containing more than 5% methanol. Fuel system damage and performance problems may result.

Gasoline/Ether Blends - The most common ether is methyl tertiary butyl ether (MTBE). You may use gasoline containing up to 15% MTBE.

NOTE

- *Other oxygenates approved for use in unleaded gasoline include TAME (up to 16.7 %) and ETBE (up to*

17.2 %). Fuel containing these oxygenates can also be used in your Kawasaki.

NOTICE

Never use gasoline with an octane rating lower than the minimum specified by Kawasaki. Never use “gasohol” with more than 10% ethanol, or more than 5% methanol. Gasoline containing methanol must also be blended with solvents and corrosion inhibitors.

NOTICE

Certain ingredients of gasoline may cause paint fading or damage. Be extra careful not to spill gasoline or gasoline oxygenate blends during refueling.

When not operating your Kawasaki for 30 to 60 days, mix a fuel stabilizer (such as STA-BIL) with the gasoline in the fuel tank. Fuel stabilizer additives inhibit oxidation of the fuel which minimizes gummy deposits.

Never store this product with “gasohol” in the fuel system. Before storage it is recommended that you drain all fuel from the fuel tank. See the Storage section in this manual.

Stand

The motorcycle is equipped with a side stand.

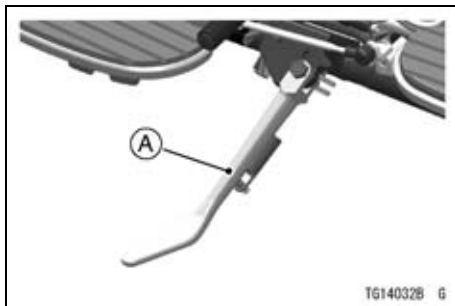

A. Side Stand

NOTE

- *When using the side stand, turn the handlebar to the left.*

Do not sit on the motorcycle while it is on its side stand. Always kick the stand fully up before sitting on the motorcycle.

NOTE

- *The motorcycle is equipped with a side stand switch. This switch is designed so that the engine does not start if the transmission is in gear and the side stand is down.*

Seat

Passenger's Seat Removal

- Insert the ignition key into the seat lock.
- Turn the ignition key counterclockwise, and the passenger's seat is lifted.

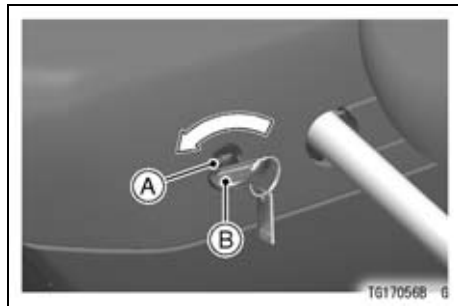

- A. Lock**
- B. Ignition Key**

- Pull up the passenger's seat to the front.

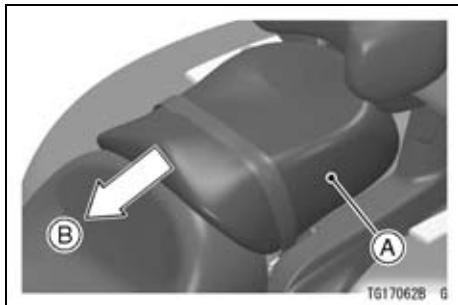

A. Passenger's Seat
B. Front

Rider's Seat Removal

- Remove the passenger's seat.
- Pull up the rear of the rider's seat to clear the hold portions, and then pull the seat to the rear.

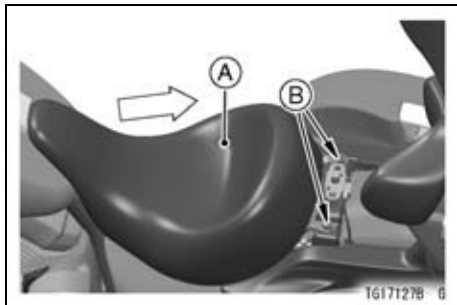

A. Rider's Seat
B. Hold Portions

Rider's Seat Installation

- To install the rider's seat, insert the tab at the holder and engage the two grommet holes onto the two projections.

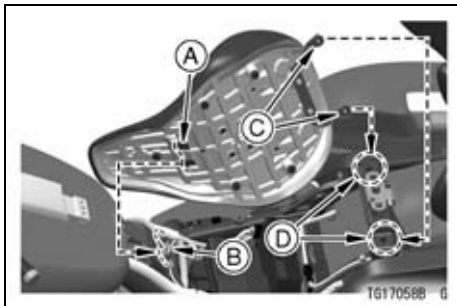

- A. Tab
- B. Holder
- C. Holes
- D. Projections

Passenger's Seat Installation

- Insert the tab on the rear of the passenger's seat into the slot on the rear fender.
- Insert the left and right projections at the front of the passenger's seat into the left and right holes on the frame.

- Push down the front part of the passenger's seat until the lock clicks.

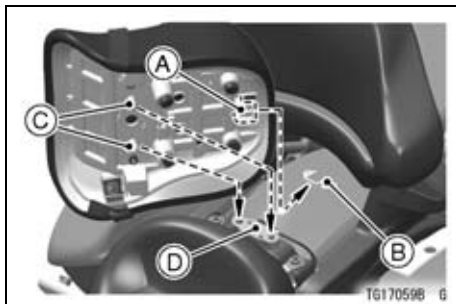

- A. Tab
- B. Holder
- C. Projections
- D. Holes

- Pull up the front and rear ends of the passenger's and rider's seats to make sure they are securely locked.

Tool Kit

The tool kit is located under the rider's seat.

The kit contains tools that can be helpful in making roadside repairs, adjustments, and some maintenance procedures explained in this manual.

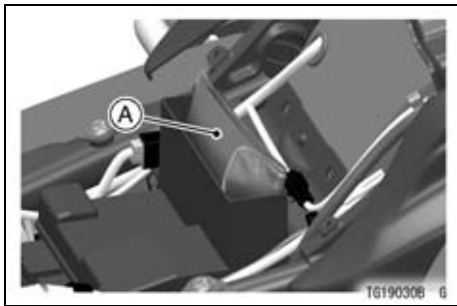

A. Tool Kit

Leg Louvers

This motorcycle is equipped with the leg louvers in the leg shields. Leg Louvers can control air volume flowing to the rider's legs in four levels with Leg louver lever. If you feel hot or cold around your legs, adjust the temperature by opening or closing the lever.

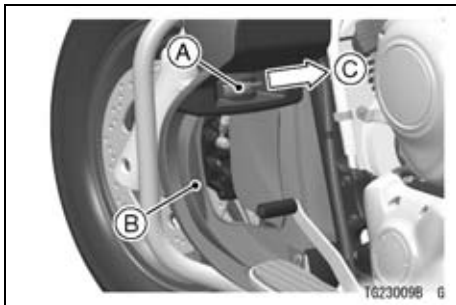

- A. Leg Louver Lever
- B. Leg Louver
- C. To Open

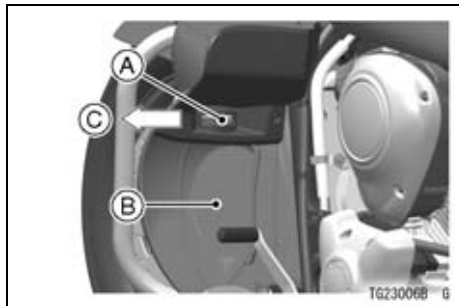

- A. Leg Louver Lever
- B. Leg Louver
- C. To Close

NOTE

- *Do not adjust the leg shield while riding the motorcycle. The motorcycle must be stopped in a safe place to adjust the leg shield.*

Special Warning on the Use of Fairing Pockets, Saddlebags, and Travel Trunk

Before riding the motorcycle, always double-check the saddlebags and travel trunk for secure mounting in their respective brackets. Make sure that the luggage holders fully engage saddlebags and travel trunk by trying to remove them away from their brackets. Make sure that the lids and fairing pockets are securely latched or locked.

 **WARNING**

The sudden detachment or loss of a saddlebag or travel trunk or sudden opening of one of the lids could distract or alarm the motorcycle rider, and the consequent loss of attention to road and traffic conditions could cause loss of control and a serious accident. Also the sudden change of vehicle balance resulting from the loss of a saddlebag could cause loss of control and a serious accident. A dislodged saddlebag could physically obstruct the motorcycle's path, or interfere in the path of a following motorcycle or other vehicle. This could cause a loss of control by one of the motorcycle riders or another vehicle driver with a consequent accident. Be sure the saddlebags are securely fastened to the motorcycle before each ride.

⚠ WARNING

Riding with an open saddlebag lid or travel trunk lid could allow clothing or other objects to fall into the rear wheel, resulting in rear wheel lockup and loss of control. Keep both saddlebag covers or travel trunk cover securely locked when riding.

Fairing Pockets

- To open the left and right fairing pocket lid, insert the ignition key into the lock and turn clockwise, and then open the fairing pocket lid.

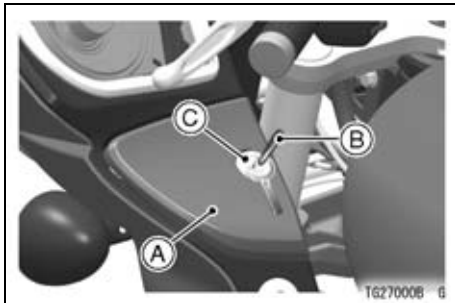

- A. Fairing Pocket Lid
- B. Ignition Key
- C. Lock

NOTICE

Storage compartments are not sealed. Store only waterproof items while riding in the rain or washing.

Saddlebags

The saddlebags are provided at both sides of the rear wheel to carry baggage.

To open the saddlebag lid

- Insert the ignition key into the lid lock, and then turn the ignition key counterclockwise.
- Pull the knob outward all the way to open the saddlebag lid.

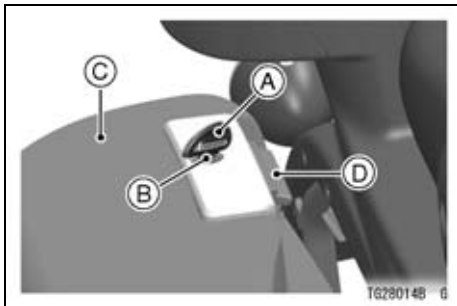

- A. Ignition Key
- B. Lid Lock
- C. Saddlebag Lid
- D. Knob

To close the saddlebag lid

- While holding the knob pulled fully out, push the lid back against the saddlebag all the way.
- Release the knob, and then turn the key clockwise and pull it out.

- Pull the knob to make sure the lid is securely locked.

To remove the saddlebag

- Open the saddlebag lid and take off the bolts inside the saddle bag, and then pull up the saddlebag.



- A. Bolts

94 GENERAL INFORMATION

To install the saddlebag

- While aligning the protrusions on the bottom of the saddlebag with the holes in the lower bracket, engage the hook on the back of the saddlebag with the upper bracket, then push it down.
- Install the bolts and tighten them securely.

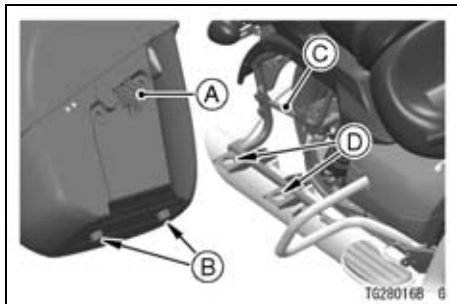

- A. Hook
- B. Protrusions
- C. Upper Bracket
- D. Holes

 **WARNING**

Overloading the motorcycle with cargo and/or passengers, and/or not balancing the weight of items carried in each saddlebag may cause adverse handling, loss of control and an accident resulting in serious injury or death. Do not carry loads of more than 7 kg (15 lb) in each saddlebag. Distribute the load equally on both sides of the motorcycle to minimize imbalance. Do not exceed the total payload limit of 180 kg (397 lb), including rider, passenger, baggage, and accessories. Do not exceed the vehicle speed of 130 km/h (80 mph) when carrying a passenger and/or cargo. Also reduce speed according to road or weather condition, etc. Failure to adjust the speed to compensate for added weight and other conditions may result in a loss of control and subsequent accident.

NOTICE

Do not sit on the saddlebags.
Do not put load on the covers.

Travel Trunk

The travel trunk is provided at the rear of the motorcycle to carry baggage.

To open the travel trunk lid

- Insert the ignition key into the lock and turn counterclockwise.
- Pull up the two latches, and then open the travel trunk lid.

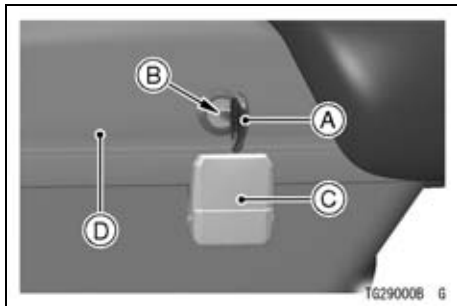

- A. Ignition Key
- B. Lock
- C. Latch
- D. Travel Trunk Lid

To close the travel trunk lid

- Close the travel trunk lid, and then insert the ignition key into the lock and turn clockwise and then lock the latch.
- Pull up the travel trunk lid to make sure the lid is securely locked.

 **WARNING**

Overloading the motorcycle with cargo and/or passengers, and/or not balancing the weight of items carried in the travel trunk may cause adverse handling, loss of control and an accident resulting in serious injury or death. Do not carry loads of more than 7 kg (15 lb) in the travel trunk. Do not exceed the total payload limit of 180 kg (397 lb), including rider, passenger, baggage, and accessories. Do not exceed the vehicle speed of 130 km/h (80 mph) when carrying a passenger and/or cargo. Also reduce speed according to road or weather condition, etc. Failure to adjust the speed to compensate for added weight and other conditions may result in a loss of control and subsequent accident.

Accessory Socket/Connectors

The electric power of the battery can be used through the electric accessory connectors.

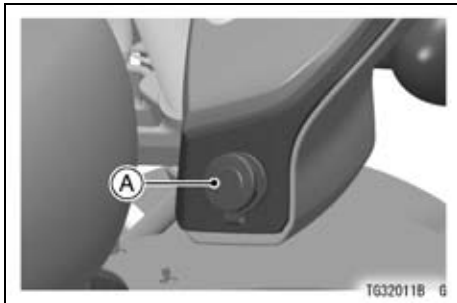

A. Accessory Socket

NOTICE

Do not operate this motorcycle in the rain or wash the motorcycle with no particular waterproofing accessory equipped. Always put the cap on the socket when the accessory is not used.

- AUX connector and iPod connector are located inside the left Fairing pocket.

Observe and follow the notes listed below.

Accessory Connectors (Under Audio Player)

Polarity	Wire Color
(+)	Brown/Blue
(-)	Black/Yellow

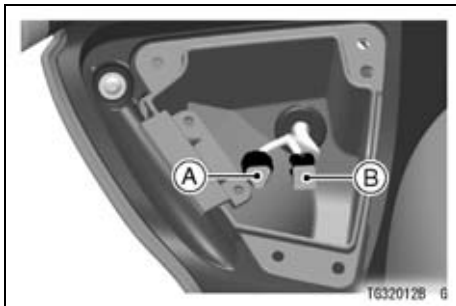

- A. AUX Connector
- B. iPod Connector

- Electrical connectors are located under the audio player and under the rider's seat.

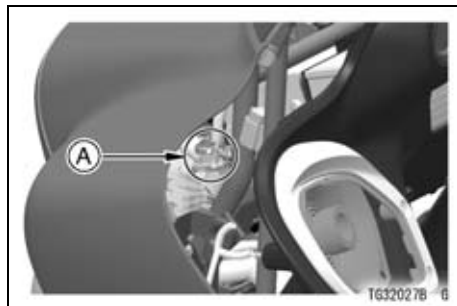

- A. Accessory Connectors (Under Audio Player)

100 GENERAL INFORMATION

Observe and follow the notes listed below.

Accessory Connectors (Under Rider's Seat)

Polarity	Wire Color
(+)	Brown/Blue
(-)	Black/Yellow

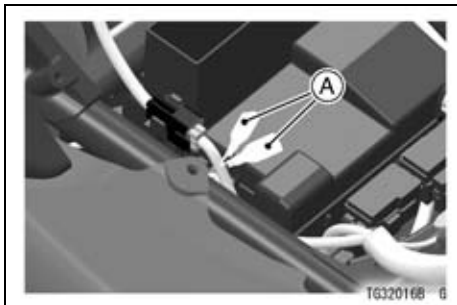

A. Accessory Connectors (Under Rider's Seat)

Observe and follow the notes listed below.

Accessory Connectors for Rear Speakers (Under Rider's Seat)

Connectors	Polarity	Wire Color
Right	(+)	Black/White
	(-)	Blue/Red
Left	(+)	Black/Blue
	(-)	Blue/White

Accessory Connectors for Intercom (Under Rider's Seat)

Purpose	Connector Color
Rider	Black
Passenger	Gray

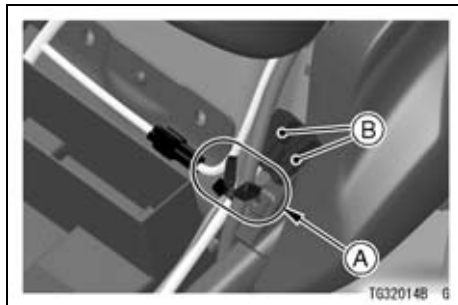

- A. Accessory Connectors for Rear Speaker
(Under Rider's Seat)**
- B. Accessory Connectors for Intercom
(Under Rider's Seat)**

Observe and follow the notes listed below.

Accessory Connectors for Navigation System (Under Audio Player)

Purpose	Polarity	Wire Color
Navi. Audio Ground	(-)	Pink
Navi. Audio Left	(+)	Gray
Navi. Audio Right	(+)	Violet
Navi. Ground	(-)	Yellow/Black
Navi. Power	(+)	White

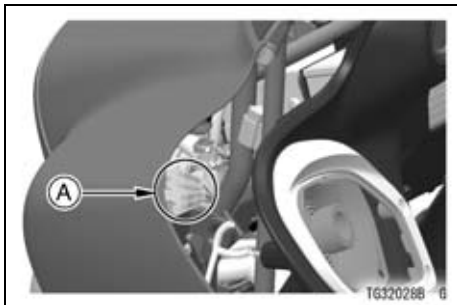

A. Accessory Connectors for Navigation System

NOTICE

If using an accessory in the socket, unless it has a waterproof connection do not operate this motorcycle in the rain or wash it. Always put the cap on the socket when the accessory is not used.

- When using the electric accessory connectors, the electric accessory connection to the connectors should be done by an authorized Kawasaki dealer.

NOTICE

The vehicle has an electrical accessory circuit (20 A fuse) for the socket and connectors. Always install a fuse 20 A or less for the circuit.

Do not connect more than 120 W of total load to the vehicle's electrical system or the battery may become discharged, even with the engine running.

 **WARNING**

Take care not to pinch any wire between the seat and the frame or between other parts to avoid a short circuit.

BREAK-IN

The first 1 600 km (1 000 miles) that the motorcycle is ridden is designated as the break-in period. If the motorcycle is not used carefully during this period, you may very well end up with a "broken down" instead of a "broken in" motorcycle after a few thousand kilometers.

The following rules should be observed during the break-in period.

- The table shows maximum recommended engine speed during the break-in period.

Distance traveled	Maximum engine speed
0 ~ 800 km (0 ~ 500 miles)	2 500 r/min (rpm)
800 ~ 1 600 km (500 ~ 1 000 miles)	3 500 r/min (rpm)

NOTE

- *When operating on public roadways, keep maximum speed under traffic law limits.*

- Do not start moving or race the engine immediately after starting it, even if the engine is already warm. Run the engine for two or three minutes at idle speed to give the oil a chance to work up into all the engine parts.
- Do not race the engine while the transmission is in neutral.



WARNING

New tires are slippery and may cause loss of control and injury. A break-in period of 160 km (100 miles) is necessary to establish normal tire traction. During break-in, avoid sudden and maximum braking and acceleration, and hard cornering.

In addition to the above, at 1 000 km (600 miles) it is extremely important that the owner has the initial maintenance service performed by a competent mechanic following the procedures in the Service Manual.

HOW TO RIDE THE MOTORCYCLE

Starting the Engine

- Check that the engine stop switch is in the  position.

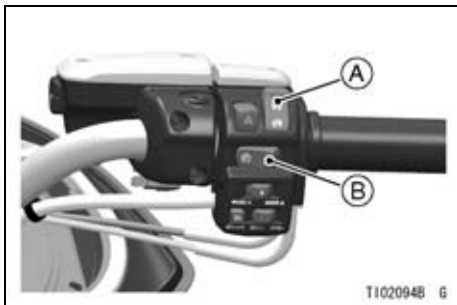

- A. Engine Stop Switch
- B. Starter Button

NOTICE

This motorcycle has ETV (Electronic Throttle Valve) system. After the ignition switch is turned off, the throttle valve opens and closes for about 6 seconds. Do not remove the battery or fuse during this open/close operation.

- Insert the ignition key.
- Turn the ignition key to ON.

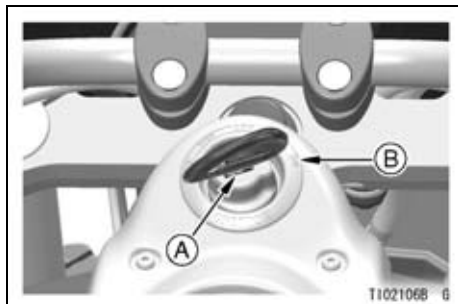

- A. Ignition Switch
B. ON Position

- Make sure the transmission is in neutral.

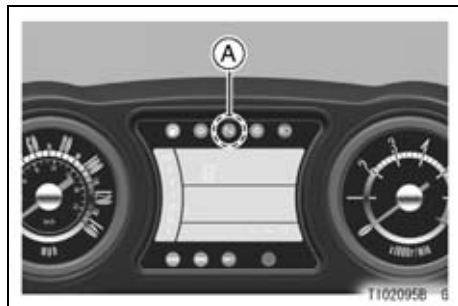

A. Neutral Indicator Light

NOTE

- *The motorcycle is equipped with a vehicle-down sensor, which causes the engine to stop automatically when the motorcycle falls down. After righting the motorcycle, first turn the ignition key to “OFF” and then back to “ON” before starting the engine.*

108 HOW TO RIDE THE MOTORCYCLE

- Without holding the throttle grip, push the starter button to start the engine.

NOTICE

Do not operate the starter continuously for more than 5 seconds, or the starter will overheat and the battery power will drop temporarily. Wait 15 seconds between each operation of the starter to let it cool and the battery power recover.

NOTE

- *The motorcycle is equipped with a starter lockout switch. This switch is designed so that the engine does not start if the transmission is in gear and the side stand is down. However, the engine can be started if the clutch*

lever is pulled and the side stand is fully up.

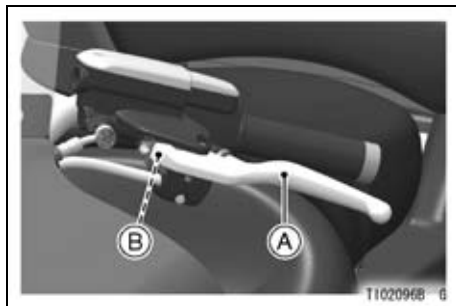

- A. Clutch Lever
- B. Starter Lockout Switch

NOTICE

Do not let the engine idle longer than five minutes, or engine overheating and damage may occur.

Jump Starting

If your motorcycle battery is "run down," it should be removed and charged. If this is not practical, a 12 volt booster battery and jumper cables may be used to start the engine.

DANGER

Battery acid generates hydrogen gas which is flammable and explosive under certain conditions. It is present within a battery at all times, even in a discharged condition. Keep all flames and sparks (cigarettes) away from the battery. Wear eye protection when working with a battery. In the event of battery acid contact with skin, eyes, or clothing, wash the affected areas immediately with water for at least 5 minutes. Seek medical attention.

Connecting Jumper Cables

- Remove the rider's seat.
- Make sure the ignition key is turned to "OFF."

110 HOW TO RIDE THE MOTORCYCLE

- Connect a jumper cable from the positive (+) terminal of the booster battery to the positive (+) terminal of the motorcycle battery.

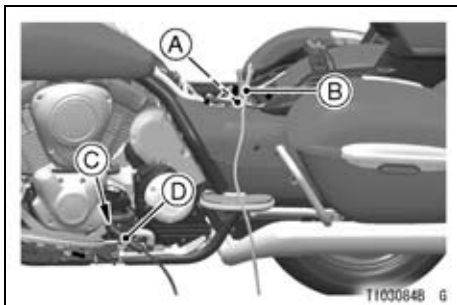

- A. Motorcycle Battery Positive (+) Terminal
- B. From Booster Battery Positive (+) Terminal
- C. Shift Pedal
- D. From Booster Battery Negative (-) Terminal

- Connect another jumper cable from the negative (-) terminal of the booster battery to your motorcycle

shift pedal or other unpainted metal surface. Do not use the negative (-) terminal of the battery.

⚠ DANGER

Batteries contain sulfuric acid that can cause burns and produce hydrogen gas which is highly explosive. Do not make this last connection at the fuel system or battery. Take care not to touch the positive and negative cables together, and do not lean over the battery when making this last connection. Do not connect to a frozen battery. It could explode. Do not reverse polarity by connecting positive (+) to negative (-), or a battery explosion and serious damage to the electrical system may occur.

- When starting the engine, make sure to follow the following procedure.
- Turn on the ignition switch first, and then turn it off.

NOTICE

Do not remove the battery and fuse for 6 seconds after turning off the ignition switch.

NOTICE

Do not operate the starter continuously for more than 5 seconds or the starter will overheat and the battery power will drop temporarily. Wait 15 seconds between each operation of the starter to let it cool and the battery power recover.

- After the engine has started, disconnect the jumper cables. Disconnect the negative (-) cable from the motorcycle first. Reinstall the removed parts.

Moving Off

- Check that the side stand is up.
- Pull in the clutch lever.
- Shift into 1st gear.
- Open the throttle a little, and start to let out the clutch lever very slowly.
- As the clutch starts to engage, open the throttle a little more, giving the engine just enough fuel to keep it from stalling.

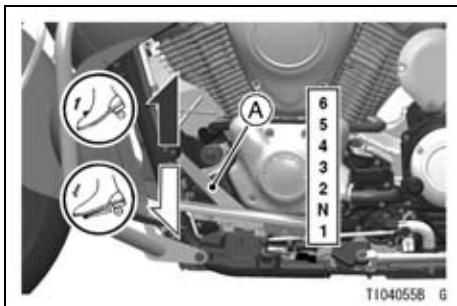

A. Shift Pedal

NOTE

- *The motorcycle is equipped with a side stand switch. This switch is designed so that the engine does not start if the transmission is in gear and the side stand is down.*

Shifting Gears

- Close the throttle while pulling in the clutch lever.
- Shift into the next higher or lower gear. For smooth riding, shift up or down when the motorcycle is operated the speeds shown in the table below.

WARNING

Downshifting at high speed can make the rear wheel skid and cause an accident resulting in severe injury or death, as well as cause the engine to overrev and damage it. When shifting down to a lower gear, do not shift at such a high speed that engine rpm jumps excessively. Downshift at the vehicle speeds shown in the table in this section.

- Open the throttle half way, while releasing the clutch lever.

NOTE

- *The transmission is equipped with a positive neutral finder. When the motorcycle is standing still, the transmission cannot be shifted past neutral from 1st gear. To use the positive neutral finder, shift down to 1st gear, then lift up on the shift pedal while standing still. The transmission will shift only into neutral.*

114 HOW TO RIDE THE MOTORCYCLE

Vehicle speed when shifting

Shifting up	km/h (mph)	Shifting down	km/h (mph)
1st → 2nd	20 (12)	6th → 5th	45 (28)
2nd → 3rd	30 (19)	5th → 4th	40 (25)
3rd → 4th	40 (25)	4th → 3rd	30 (19)
4th → 5th	50 (31)	3rd → 2nd	20 (12)
5th → 6th	60 (38)	2nd → 1st	15 (9)

Braking

- Close the throttle completely, leaving the clutch engaged (except when shifting gears) so that the engine will help slow down the motorcycle.
- Shift down one gear at a time so that you are in 1st gear when you come to a complete stop.
- When stopping, always apply both brakes at the same time. Normally the front brake should be applied a little more than the rear. Shift down or fully disengage the clutch as necessary to keep the engine from stalling.
- Never lock the brakes, or it will cause the tires to skid. When turning a corner, it is better not to brake at all. Reduce your speed before you get into the corner.
- Even in motorcycles equipped with K-ACT ABS, braking during cornering

may cause wheel slip. When turning a corner, it is better to limit braking to the light application of both brakes or not to brake at all. Reduce your speed before you get into the corner.

- For emergency braking, disregard downshifting, and concentrate on applying the brakes as hard as possible without skidding.

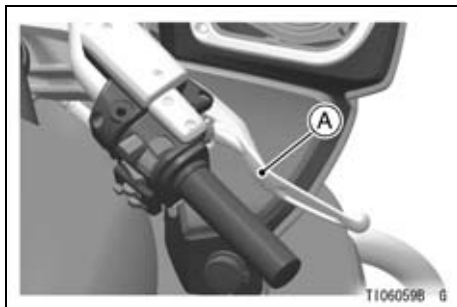

A. Front Brake Lever

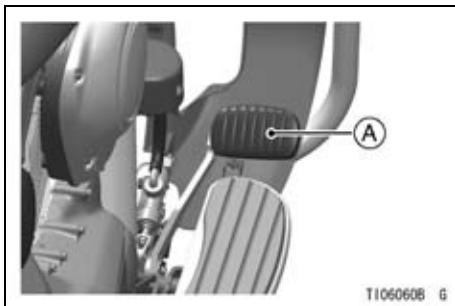

A. Rear Brake Pedal

NOTICE

In order to protect the emission control parts, do not turn off the ignition switch when the motorcycle is in motion.

Kawasaki Advanced Coactive-braking Technology (K-ACT) - Anti-lock Brake System (ABS) for models equipped with K-ACT ABS

K-ACT system supports the distribution of the front/rear brake force in an optimum balance to maintain a stable vehicle position. When using the front brake lever, the right and left front calipers and the rear brake operate. When using the rear brake pedal, the rear brake and the right front caliper operate. The cooperative brake balance is controlled optimally in response to the vehicle status such as the brake input and the vehicle speed.

ABS is designed to help prevent the wheels from locking up when the brakes are applied hard while running straight. The ABS automatically regulates brake force. Intermittently gaining gripping force and braking force helps

prevent wheel lock-up and allows stable steering control while stopping.

Although K-ACT system supports the distribution of the front/rear brake force in an optimum balance. The ABS provides stability while stopping by preventing wheel lock-up, remember the following characteristics:

- To apply the brake effectively, use the front brake lever and rear brake pedal simultaneously in the same manner as conventional motorcycle brake system.
- K-ACT ABS cannot compensate for adverse road conditions, misjudgment or improper application of brakes. You must take the same care as with motorcycles not equipped with K-ACT ABS.
- ABS is not designed to shorten the braking distance. On loose, uneven

or downhill surface, the stopping distance of a motorcycle with ABS may be longer than that of equivalent motorcycle without ABS. Use special caution in such areas.

- ABS will help prevent wheel lock-up when braking in a straight line, but it cannot control wheel slip which may be caused by braking during cornering. When turning the corner, it is better to limit braking to the light application of both brakes or not to brake at all. Reduce your speed before you get into the corner.
- Same as conventional brake system, an excessive sudden braking may cause wheel lock up that makes it harder to control a motorcycle.
- During braking, K-ACT ABS will not prevent the rear wheel lifting.

 **WARNING**

K-ACT ABS cannot protect the rider from all possible hazards and is not a substitute for safe riding practices. Be aware of how the K-ACT ABS system operates and its limitations. It is the rider's responsibility to ride at appropriate speeds and manner for weather, road surface and traffic conditions.

- The computers integrated in the K-ACT ABS compares vehicle speed with wheel speed. Since non-recommended tires can affect wheel speed, they may confuse the computers, which can extend braking distance.

 **WARNING**

Use of non-recommended tires may cause malfunctioning of K-ACT ABS and can lead to extended braking distance. The rider could have an accident as a result. Always use recommended standard tires for this motorcycle.

NOTE

- *When K-ACT system is functioning, you may feel a pulsing in the brake lever or pedal and feel a change of the braking touch. When the ABS is functioning, you may feel a pulsing in the brake lever or pedal. These are normal. Maintain braking pressure.*
- *K-ACT system does not function at the speed of approx. 20 km/h (13 mph) or below when the brake starts to be applied. ABS does not function*

at the speed of approx. 5 km/h (3.1 mph) or below.

- *K-ACT ABS does not function if the battery is discharged. When driving with an insufficiently charged battery, K-ACT ABS may not function. Keep the battery in good condition in reference to "Battery maintenance" section.*

K-ACT ABS Indicator Light

Normally the K-ACT ABS indicator light goes on when the ignition switch is turned on and goes off shortly after the motorcycle starts moving.

If the K-ACT ABS indicator light shows any of the following, a fault or faults may have taken place in the K-ACT ABS. You should have the K-ACT ABS checked by an authorized Kawasaki dealer.

- The light does not go on when the ignition switch is turned on.

- The light remains lit after the motorcycle starts moving.
- The light goes on.

Remember that the K-ACT ABS does not function when the indicator light is on. If the K-ACT ABS fails, the front and rear brakes work normally as a conventional brake system. However, the effectiveness of the brake, especially the rear brake, decreases compared to when K-ACT system functions normally.

NOTE

- *K-ACT ABS indicator light may go on under motorcycle riding condition. (ex. The front or rear wheel races.) In this case, first turn the ignition key to "OFF", and then back to "ON". K-ACT ABS indicator lights goes off by this operation, but if K-ACT ABS indicator light remains lit after the motorcycle runs at the speed of approx. 5*

km/h (3.1 mph) or below, you should have the K-ACT ABS checked by an authorized Kawasaki dealer.

- *When the K-ACT ABS indicator light is flashing, the K-ACT ABS has been in the low voltage mode (the battery voltage decreases). When it is in the low voltage mode, the K-ACT system does not function, but the ABS functions. The ignition switch is turned off to recover the K-ACT system. At this time, the battery must be in the normal condition. If the low voltage mode continues, you should have the K-ACT ABS checked by an authorized Kawasaki dealer.*

Stopping the Engine

- Close the throttle completely.
- Shift the transmission into neutral.
- Turn the ignition key to “OFF”.
- Support the motorcycle on a firm, level surface with the side stand.
- Lock the steering.

NOTE

- *The motorcycle is equipped with a vehicle-down sensor, which causes the engine to stop automatically when the motorcycle falls down. After righting the motorcycle, first turn the ignition key to “OFF” and then back to “ON” before starting the engine.*

Stopping the Motorcycle in an Emergency

Your Kawasaki Motorcycle has been designed and manufactured to provide you optimum safety and convenience. However, in order to fully benefit from Kawasaki's safety engineering and craftsmanship, it is essential that you, the owner and operator, properly maintain your motorcycle and become thoroughly familiar with its operation. Improper maintenance can create a dangerous situation known as throttle failure.

Two of the most common causes of throttle failure are:

1. An improperly serviced or clogged air cleaner may allow dirt and dust to enter the throttle body and stick the throttle open.

2. During removal of the air cleaner, dirt is allowed to enter and jam the throttle body.

In an emergency situation such as throttle failure, your vehicle may be stopped by applying the brakes and disengaging the clutch. Once this stopping procedure is initiated, the engine stop switch may be used to stop the engine. If the engine stop switch is used, turn off the ignition switch after stopping the motorcycle.

Parking

WARNING

Operating or parking the vehicle near flammable materials can cause a fire, and can result in property damage or severe personal injury.

Do not idle or park your vehicle in an area where tall or dry vegetation, or other flammable materials could come into contact with the muffler or exhaust pipe.

WARNING

The engine and exhaust system get extremely hot during normal operation and can cause serious burns.

Never touch a hot engine, exhaust pipe, or muffler during operation or after stopping the engine.

- Shift the transmission into neutral and turn the ignition key to “OFF”.
- Support the motorcycle on a firm, level surface with the side stand.

NOTICE

Do not park on a soft or steeply inclined surface, or the motorcycle may fall over.

- If parking inside a garage or other structure, be sure it is well ventilated

and the motorcycle is not close to any source of flame or sparks; this includes any appliance with a pilot light.

 **WARNING**

Gasoline is extremely flammable and can be explosive under certain conditions, creating the potential for serious burns. Turn the ignition switch to “OFF”. Do not smoke. Make sure the area is well ventilated and free from any source of flame or sparks; this includes any appliance with a pilot light.

- Lock the steering to help prevent theft.

Catalytic Converter

This motorcycle is equipped with a catalytic converter in the exhaust system. The converter reacts with carbon monoxide, hydrocarbons and nitrogen oxides to convert them into carbon dioxide, water, nitrogen and oxygen resulting in much cleaner exhaust gases to be discharged into the atmosphere.

For proper operation of the catalytic converter, the following cautions must be observed.

 **WARNING**

Operating or parking the vehicle near flammable materials can cause a fire, and can result in property damage or severe personal injury.

Do not idle or park your vehicle in an area where tall or dry vegetation, or other flammable materials could come into contact with the muffler or exhaust pipe.

 **WARNING**

The engine and exhaust system get extremely hot during normal operation and can cause serious burns.

Never touch a hot engine, exhaust pipe, or muffler during operation or after stopping the engine.

- Use only unleaded gasoline. Never use leaded gasoline. Leaded gasoline significantly reduces the capability of the catalytic converter.
- Do not operate the vehicle with the engine or any one cylinder misfiring. Under these conditions unburned air/fuel mixture flowing out of engine excessively accelerates reaction in the converter allowing the converter to overheat and become damaged when the engine is hot, or reduces converter performance when the engine is cold.

Electronic Throttle Valve (ETV) System

This motorcycle has the ETV system. ETV system is a system which opens and closes the throttle valve electrically, not by the cables. When a failure occurs in the system, the service code is shown on the meter, and the warning indicator light is blinking and fuel injection warning symbol (FI) goes on. Under some failure conditions of ETV system, the maximum speed and the engine revolution speed are controlled to certain limit. The service codes shown on the meter are 11, 18, 49, 58, 97, 98 and the display is as follows.

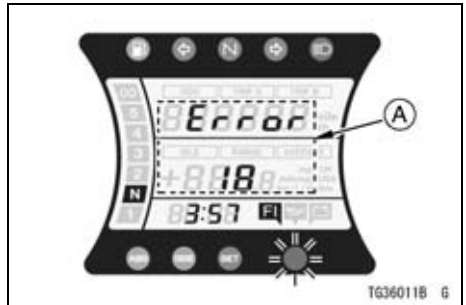

A. Service Code

- If the service code is shown on the meter, ask an authorized Kawasaki dealer for repair.

SAFE OPERATION

Safe Riding Technique

The points given below are applicable for everyday motorcycle use and should be carefully observed for safe and effective vehicle operation.

For safety, eye protection and a helmet are strongly recommended. You should be aware of and verify the applicable safety regulations in force prior to riding your motorcycle. Gloves and suitable footwear should also be used for added protection in case of a mishap.

A motorcycle does not provide the impact protection of an automobile, so defensive riding in addition to wearing protective apparel is extremely important. Do not let protective apparel give you a false sense of security.

When riding always keep both hands on the handlebars and both feet on the footpegs. Removing your hands from the handlebars or feet from the footpegs while riding can be hazardous. If you remove even one hand or foot, you can reduce your ability to control the motorcycle.

Before changing lanes, look over your shoulder to make sure the way is clear. Do not rely solely on the rear view mirror; you may misjudge a vehicle's distance and speed, or you may not see it at all.

In general your actions should be smooth as sudden acceleration, braking or turning may cause loss of control, especially when riding in wet conditions or on loose roadway surfaces, when the ability to maneuver will be reduced.

When going up steep slopes, shift to a lower gear so that there is plenty of power to spare rather than overloading the engine.

When applying the brakes, use both the front and rear brakes. Applying only one brake for sudden braking may cause the motorcycle to skid and lose control.

When going down long slopes, control vehicle speed by closing the throttle. Use the front and rear brakes for auxiliary braking.

In wet conditions, rely more on the throttle to control vehicle speed and less on the front and rear brakes. The throttle should also be used judiciously to avoid skidding the rear wheel from too rapid acceleration or deceleration.

Riding at the proper rate of speed and avoiding unnecessarily fast acceleration are important not only for safety and low fuel consumption but also for long vehicle life and quieter operation.

On rough roads, exercise caution, slow down, and grip the fuel tank with the knees for better stability.

When quick acceleration is necessary as in passing, shift to a lower gear to obtain the necessary power.

128 SAFE OPERATION

Do not downshift at too high an r/min (rpm) to avoid damage to the engine from overrevving.

Avoiding unnecessary weaving is important to the safety of both the rider and other motorists.

Daily Checks

Check the following items each day before you ride. The time required is minimal, and habitual performance of these checks will help ensure you a safe, reliable ride.

If any irregularities are found during these checks, refer to the Maintenance and Adjustment chapter or see your dealer for the action required to return the motorcycle to a safe operating condition.

WARNING

Failure to perform these checks before operation may result in serious damage or an accident. Always perform daily checks before operation.

DANGER

Exhaust gas contains carbon monoxide, a colorless, odorless poisonous gas. Inhaling carbon monoxide can cause serious brain injury or death. DO NOT run the engine in enclosed areas. Operate only in a well-ventilated area.

Fuel	Adequate supply in tank, no leaks.
Engine oil	Oil level between level lines.
Tires	Air pressure (when cold):

130 SAFE OPERATION

Front	Up to 180 kg (397 lb) Load	200 kPa (2.00 kgf/cm ² , 28 psi)
Rear	Up to 97.5 kg (215 lb) Load	250 kPa (2.50 kgf/cm ² , 36 psi)
	97.5 ~ 180 kg (215 ~ 397 lb) Load	280 kPa (2.80 kgf/cm ² , 40 psi)

Install the air valve cap.

- Nuts, bolts, fasteners .. Check that steering and suspension components, axles, and all controls are properly tightened or fastened.
- Steering Action smooth but not loose from lock to lock.
No binding of control cables.
- Brakes Brake pad wear: Lining thickness more than 1 mm (0.04 in.) left.
No brake fluid leakage.
- Throttle Throttle grip play 2 ~ 3 mm (0.08 ~ 0.12 in.).
- Clutch No clutch fluid leakage.
- Coolant No coolant leakage.
Coolant level between level lines (when engine is cold).
- Electrical equipment ... All lights and horn work.
- Engine stop switch Stops engine.
- Side stand Returns to its fully up position by spring tension.
Return spring not weak or not damaged.

Additional Considerations for High Speed Operation

WARNING

Handling characteristics of a motorcycle at high speeds may vary from those you are familiar with at legal highway speeds. Do not attempt high speed operation unless you have received sufficient training and have the required skills.

Brakes: The importance of the brakes, especially during high speed operation, cannot be overemphasized. Check to see that they are correctly adjusted and functioning properly.

Steering: Looseness in the steering can cause loss of control. Check to see that the handlebar turns freely but has no play.

Tires: High speed operation is hard on tires, and good tires are crucial for riding safety. Examine their overall condition, inflate them to the proper pressure, and check the wheel balance.

Fuel: Have sufficient fuel for the high fuel consumption during high speed operation.

Engine Oil: To avoid engine seizure and resulting loss of control, make sure that the oil level is at the upper level line.

Coolant: To avoid overheating, check that the coolant level is at the upper level line.

132 SAFE OPERATION

Electrical Equipment: Make sure that the headlight, tail/brake light, turn signals, horn, etc., all work properly.

Miscellaneous: Make sure that all nuts and bolts are tight and that all safety related parts are in good condition.

MAINTENANCE AND ADJUSTMENT

The maintenance and adjustments outlined in this chapter must be carried out and must be done in accordance with the Periodic Maintenance Chart to keep the motorcycle in good running condition. **The initial maintenance is vitally important and must not be neglected.**

With a basic knowledge of mechanics and the proper use of tools, you should be able to carry out many of the maintenance items described in this chapter. If you lack proper experience or doubt your ability, all adjustments, maintenance, and repair work should be completed by a qualified technician.

Please note that Kawasaki cannot assume any responsibility for damage resulting from incorrect or improper adjustment done by the owner.

EMISSION CONTROL INFORMATION

To protect the environment in which we all live, Kawasaki has incorporated crankcase emission (1), exhaust emission (2) control systems in compliance with applicable regulations of the United States Environmental Protection Agency and California Air Resources Board. Additionally, Kawasaki has incorporated an evaporative emission control system (3) in compliance with applicable regulations of the United States Environmental Protection Agency and California Air Resources Board.

1. Crankcase Emission Control System

This system eliminates the release of crankcase vapors into the atmosphere. Instead, the vapors are routed through an oil separator to the intake side of the engine. While the engine is operating, the vapors are drawn into the combustion chamber, where they are burned along with the fuel and air supplied by the fuel injection system.

2. Exhaust Emission Control System

This system reduces the amount of pollutants discharged into the atmosphere by the exhaust of this motorcycle. The fuel, ignition and exhaust systems of this motorcycle have been carefully designed and constructed to ensure an efficient engine with low exhaust pollutant levels. The exhaust system of this model motorcycle includes a catalytic converter system.

3. Evaporative Emission Control System

The evaporative emission control system for this vehicle consists of low permeation fuel hoses and fuel tank.

3. Evaporative Emission Control System (California model only)

Vapors caused by fuel evaporation in the fuel system are not vented into the atmosphere. Instead, fuel vapors are routed into the running engine to be burned, or stored in a canister when the engine is stopped. Liquid fuel is caught by a vapor separator and returned to the fuel tank.

High Altitude Performance Adjustment Information

High altitude adjustment is not required.

MAINTENANCE AND WARRANTY

Proper maintenance is necessary to ensure that your motorcycle will continue to have low emission levels. This Owner's Manual contains those maintenance recommendations for your motorcycle. Those items identified by the Periodic Maintenance Chart are necessary to ensure compliance with the applicable standards.

As the owner of this motorcycle, you have the responsibility to make sure that the recommended maintenance is carried out according to the instructions in this Owner's Manual at your own expense.

The Kawasaki Limited Emission Control System Warranty requires that you return your motorcycle to an authorized Kawasaki dealer for remedy under warranty. Please read the warranty carefully, and keep it valid by complying with the owner's obligations it contains.

You should keep a maintenance record for your motorcycle. To assist you in keeping this record, we have provided space on pages 225 through 228 of this manual where an authorized Kawasaki dealer, or someone equally competent, can record the maintenance. You should also retain copies of maintenance work orders, bills, etc., as verification of this maintenance.

TAMPERING WITH NOISE CONTROL SYSTEM PROHIBITED:

Federal law prohibits the following acts or the causing thereof: (1) the removal or rendering inoperative by any person other than for purposes of maintenance, repair, or replacement, of any device or element of design incorporated into any new vehicle for the purpose of noise control prior to its sale or delivery to the ultimate purchaser or while it is in use, or (2) the use of the vehicle after such device or element of design has been removed or rendered inoperative by any person.

Among those acts presumed to constitute tampering are the acts listed below:

- * Replacement of the original exhaust system or muffler with a component not in compliance with Federal regulations.
- * Removal of the muffler(s) or any internal portion of the muffler(s).
- * Removal of the air box or air box cover.
- * Modifications to the muffler(s) or air intake system by cutting, drilling, or other means if such modifications result in increased noise levels.

Periodic Maintenance Chart

K : Should be serviced by an authorized Kawasaki dealer.

* : For higher odometer readings, repeat at the frequency interval established here.

: Service more frequently when operating in severe conditions: dusty, wet, muddy, high speed, or frequent starting/stopping.

e : Emission Related Items

138 MAINTENANCE AND ADJUSTMENT

1. Periodic Inspection (Engine Related Items)

Frequency	Whichever comes first ↓	*Odometer Reading km × 1 000 (mile × 1 000)							See Page
		Every	1 (0.6)	6 (3.75)	12 (7.5)	18 (11.25)	24 (15)	30 (18.75)	
Operation (Engine Items)									
Throttle control system (play, smooth return, no drag) - inspect (e)	year	●		●		●		●	169
Idle speed - inspect (e)		●		●		●		●	171
K Fuel leak (fuel hose and pipe) - inspect	year	●		●		●		●	—
K Fuel hoses damage - inspect	year	●		●		●		●	—
K Fuel hoses installation condition - inspect	year	●		●		●		●	—

Frequency	Whichever comes first ↓ Every	*Odometer Reading km × 1 000 (mile × 1 000)							See Page
		1 (0.6)	6 (3.75)	12 (7.5)	18 (11.25)	24 (15)	30 (18.75)	36 (22.5)	
Coolant level - inspect		•		•		•		•	160
Coolant leak - inspect	year	•		•		•		•	158
Radiator hoses damage - inspect	year	•		•		•		•	158
Radiator hoses installation condition - inspect	year	•		•		•		•	158
K Air suction system damage - inspect (e)				•		•		•	166

140 MAINTENANCE AND ADJUSTMENT

Frequency	Whichever comes first →								See Page
	*Odometer Reading km × 1 000 (mile × 1 000)								
Operation (Engine Items)	Every	1	6	12	18	24	30	36	
		(0.6)	(3.75)	(7.5)	(11.25)	(15)	(18.75)	(22.5)	
Evaporative emission control system - function (e) (California model only)				●		●		●	165
K Spark plug condition - inspect (e)				●		●		●	164

142 MAINTENANCE AND ADJUSTMENT

Frequency	Whichever comes first →								See Page
	↓	*Odometer Reading km × 1000 (mile × 1000)							
Operation (Chassis Items)	Every	1 (0.6)	6 (3.75)	12 (7.5)	18 (11.25)	24 (15)	30 (18.75)	36 (22.5)	
Clutch hose installation condition - inspect	year	•	•	•	•	•	•	•	–
K Drive belt deflection - inspect		•	•	•	•	•	•	•	163
K Drive belt wear - inspect		•	•	•	•	•	•	•	163
Wheels and tires:									
Tire air pressure - inspect	year			•		•		•	187
Wheels/tires damage - inspect				•		•		•	189

Frequency	Whichever comes first → ↓ *Odometer Reading km × 1000 (mile × 1000)								See Page	
	Operation (Chassis Items)	Every	1 (0.6)	6 (3.75)	12 (7.5)	18 (11.25)	24 (15)	30 (18.75)		36 (22.5)
	Tire tread wear, abnormal wear - inspect			●			●		●	189
K	Wheel bearings damage - inspect	year			●		●		●	—
Brake system:										
	Brake fluid leak - inspect	year	●	●	●	●	●	●	●	176
	Brake hoses damage - inspect	year	●	●	●	●	●	●	●	176
	Brake pad wear - inspect #			●	●	●	●	●	●	175

Frequency	Whichever comes first →								See Page	
	Operation (Chassis Items)	Every	1 (0.6)	6 (3.75)	12 (7.5)	18 (11.25)	24 (15)	30 (18.75)		36 (22.5)
*Odometer Reading km × 1000 (mile × 1000)										
Suspensions:										
	Front forks/rear shock absorber operation (damping and smooth stroke) - inspect				●		●		●	—
	Front forks/rear shock absorber oil leak - inspect	year			●		●		●	—
K	Swing arm pivot - lubricate						●			—
Steering system:										
K	Steering play - inspect	year	●		●		●		●	—

146 MAINTENANCE AND ADJUSTMENT

Frequency	Whichever comes first →								See Page
	↓	*Odometer Reading km × 1000 (mile × 1000)							
Operation (Chassis Items)	Every	1 (0.6)	6 (3.75)	12 (7.5)	18 (11.25)	24 (15)	30 (18.75)	36 (22.5)	
K Steering stem bearings - lubricate	2 years					●			—
Electrical system:									
Lights and switches operation - inspect	year			●		●		●	—
Headlight aiming - inspect	year			●		●		●	199
Side stand switch operation - inspect	year			●		●		●	—

Frequency	Whichever comes first → *Odometer Reading km × 1000 (mile × 1000)								See Page
	↓ Every	1 (0.6)	6 (3.75)	12 (7.5)	18 (11.25)	24 (15)	30 (18.75)	36 (22.5)	
Engine stop switch operation - inspect	year			•		•		•	–
Chassis:									
K Chassis parts - lubricate	year			•		•		•	202
K Bolts and nuts tightness - inspect		•		•		•		•	210

148 MAINTENANCE AND ADJUSTMENT

3. Periodic Replacement

Change/Replacement Items	Frequency	Whichever comes first → *Odometer Reading km × 1 000 (mile × 1 000)					See Page
		Every	1 (0.6)	12 (7.5)	24 (15)	36 (22.5)	
Air cleaner element - replace # (e)		every 18 000 km (12 000 mile)					167
K Engine oil - change #	year	•	•	•	•	•	153
K Oil filter - replace	year	•	•	•	•	•	153
K Fuel hoses - replace	5 years						–
K Coolant - change	3 years				•		163
K Radiator hoses and O-rings - replace	3 years				•		–
K Brake or clutch hoses - replace	4 years					•	–
K Brake or clutch fluid (front and rear) - change	2 years			•		•	174, 179

Change/Replacement Items	Frequency	Whichever comes first → *Odometer Reading km × 1 000 (mile × 1 000)					See Page
	Every	1 (0.6)	12 (7.5)	24 (15)	36 (22.5)	48 (30)	
K Rubber parts of master cylinder and caliper (or slave cylinder) - replace	4 years					●	—
K Spark plug - replace (e)		every 48 000 km (30 000 mile)					164

Engine Oil

In order for the engine, transmission, and clutch to function properly, maintain the engine oil at the proper level, and change the oil and replace the oil filter in accordance with the Periodic Maintenance Chart. Not only do dirt and metal particles collect in the oil, but the oil itself loses its lubricative quality if used too long.

WARNING

Motorcycle operation with insufficient, deteriorated, or contaminated engine oil will cause accelerated wear and may result in engine or transmission seizure, accident, and injury. Check the oil level before each ride and change the oil according to the periodic maintenance chart in the Owner's Manual.

Because of the semi-dry sump lubrication system, the engine oil level indicated on the dipstick will fluctuate depending on the motorcycle's position and engine speed when the engine is shut off. To ensure a proper reading of the engine oil level, follow the Oil Level Inspection procedures closely.

NOTICE

Racing the engine before the oil reaches every part can cause engine seizure.

Oil Level Inspection

- If the oil has just been changed or the oil temperature is low, start the engine and warm it up thoroughly until the oil temperature in the transmission room goes up about 50°C (122°F). Depending on the atmospheric temperature, the idle time

may be changed according to the following table.

Air Temperature	Idle Time (minutes)*
4°C (40 °F)	15
18°C (65°F)	10
38°C (100°F)	5

* : During this time the auxiliary cooling fan may be activated several times.

- Run the engine **at idle speed** for about 30 seconds or more. **Do not run the engine at high engine speed.** This fills the oil filter with oil. Stop the engine, then wait 3 minutes or more until the oil settles.
- Remove the oil filler cap/dipstick.
- Wipe the dipstick clean.
- With the motorcycle perpendicular to the ground, thread the oil filler

cap/dipstick fully clockwise then remove.

- Check the engine oil level on the dipstick. The oil level should come up between the low and high level lines on the dipstick.

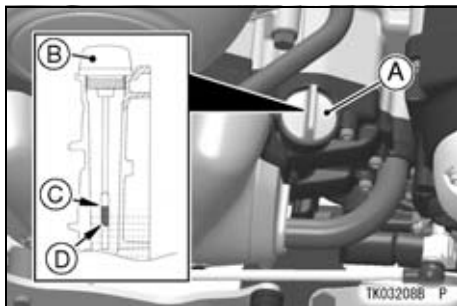

- A. Oil Filler Cap/Dipstick
- B. Screw in the oil filler cap/dipstick fully to inspect the oil level.
- C. High Level Line
- D. Low Level Line

152 MAINTENANCE AND ADJUSTMENT

- If the oil level is too high, remove the excess oil through the oil filler opening using a syringe or some other suitable device.
- If the oil level is too low, add the oil to reach the correct level. Use the same type and brand of oil that is already in the engine.

NOTICE

If the engine oil gets extremely low or if the oil pump does not function properly or oil passages are clogged, the warning indicator light under the multi-function meter and oil pressure warning symbol in the multi-function meter will go on. If they stay on when the engine speed is above idle, stop the engine immediately and have it serviced. Failure to do so could cause serious engine damage.

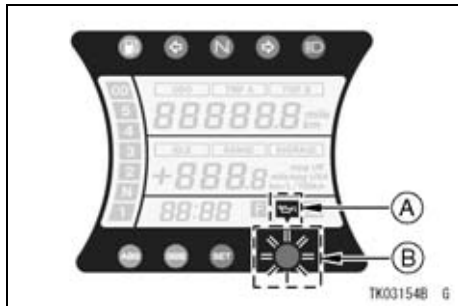

- A. Oil Pressure Warning Symbol
- B. Warning Indicator Light

Oil and/or Oil Filter Change

- Warm up the engine thoroughly, and then stop it.
- Place an oil pan beneath the engine.
- Remove the engine oil drain bolts.

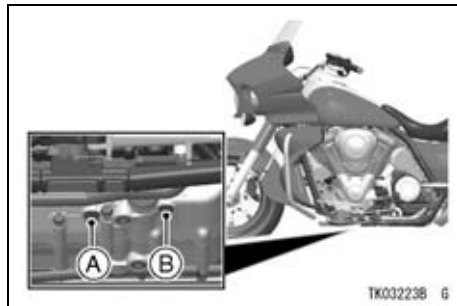

- A. Oil Pan Drain Bolt (Front)
- B. Oil Pan Drain Bolt (Rear)

154 MAINTENANCE AND ADJUSTMENT

- Let the oil completely drain with the motorcycle perpendicular to the ground.

⚠ WARNING

Engine oil is a toxic substance. Dispose of used oil properly. Contact your local authorities for approved disposal methods or possible recycling.

- Remove the oil filter and replace it with a new one.

NOTE

- *If a torque wrench or required Kawasaki special tool is not available, this item should be serviced by a Kawasaki dealer.*

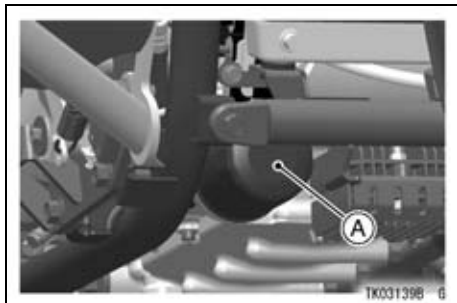

A. Oil Filter

- Apply a thin film of oil to the packing and tighten the oil filter to the specified torque.

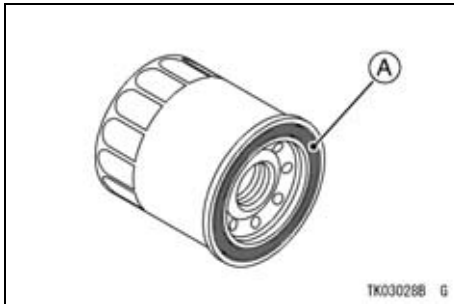

A. Packing

- Install the engine oil drain bolts with new gaskets and tighten them to the specified torque.

NOTE

○ *Replace any gaskets with new ones.*

- Fill the engine up to the upper level line with a good quality engine oil specified in the table.
- Start the engine.
- Check the oil level and for oil leakage.

Tightening Torque

Engine Oil Drain Bolts:
20 N·m (2.0 kgf·m, 15 ft·lb)
Oil Filter:
18 N·m (1.8 kgf·m, 13 ft·lb)

Recommended Engine Oil

Type: Kawasaki Performance 4-Stroke Motorcycle Oil*
Kawasaki Performance 4-Stroke Semi-Synthetic Oil*
Kawasaki Performance 4-Stroke Full Synthetic Oil*
or other 4-stroke oils with API SG, SH, SJ, SL, SM and JASO MA, MA1, MA2 rating

Viscosity: SAE 10W-40

156 MAINTENANCE AND ADJUSTMENT

*Kawasaki Performance Oils and Lubricants have been specifically engineered for your vehicle. Consistent use of these products meets or exceeds warranty and service requirements and can help to extend the life of your Kawasaki.

NOTE

○ *Do not add any chemical additive to the oil. Oils fulfilling the above requirements are fully formulated and provide adequate lubrication for both the engine and the clutch.*

Engine Oil Capacity

Capacity:

4.1 L (4.3 US qt)

[when filter is not removed]

4.3 L (4.5 US qt)

[when filter is removed]

5.0 L (5.3 US qt)

[when engine is completely dry]

Although 10W-40 engine oil is the recommended oil for most conditions, the oil viscosity may need to be changed to accommodate atmospheric conditions in your riding area.

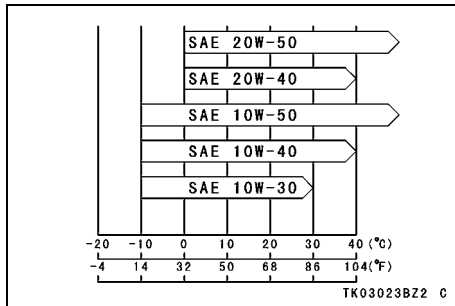

Cooling System

Radiator and Cooling Fan -

Check the radiator fins for obstruction by insects or mud. Clean off any obstructions with a stream of low-pressure water.

⚠ WARNING

The cooling fan spins at high speed and can cause serious injuries. Keep your hands and clothing away from the cooling fan blades at all times.

NOTICE

Using high-pressure water, as from a car wash facility, could damage the radiator fins and impair the radiator's effectiveness. Do not obstruct or deflect airflow through the radiator by installing unauthorized accessories in front of the radiator or behind the cooling fan. Interference with the radiator airflow can lead to overheating and consequent engine damage.

Radiator Hoses -

Check the radiator hoses for cracks or deterioration, and connections for leakage, or looseness each day before riding the motorcycle in accordance with the Periodic Maintenance Chart.

Coolant -

Coolant absorbs excessive heat from the engine and transfers it to the air at the radiator. If the coolant level becomes low, the engine overheats and may suffer severe damage. Check the coolant level each day before riding the motorcycle, and replenish coolant if the level is low. Change the coolant in accordance with the Periodic Maintenance Chart.

Information for Coolant

To protect the cooling system (consisting of the aluminum engine and radiator) from rust and corrosion, the use of corrosion and rust inhibitor chemicals in the coolant is essential. If coolant containing corrosion and rust inhibitor chemicals is not used, over a period of time, the cooling system accumulates rust and scale in the water jacket and radiator. This will clog up

the coolant passages, and considerably reduce the efficiency of the cooling system.

 **WARNING**

Coolant containing corrosion inhibitors for aluminum engines and radiators include harmful chemicals for human body. Drinking coolant can result in serious injury or death. Use coolant in accordance with the instructions of the manufacturer.

Soft or distilled water must be used with the antifreeze (see below for antifreeze) in the cooling system.

NOTICE

If hard water is used in the system, it causes scale accumulation in the water passages, and considerably reduces the efficiency of the cooling system.

If the lowest ambient temperature encountered falls below the freezing point of water, use permanent antifreeze in the coolant to protect the cooling system against engine and radiator freeze-up, as well as from rust and corrosion.

Use a permanent type of antifreeze (soft water and ethylene glycol plus corrosion and rust inhibitor chemicals for aluminum engines and radiators) in the cooling system. On the mixture ratio of coolant, choose the suitable one referring to the relation between freezing point and strength directed on the container.

NOTICE

Permanent types of antifreeze on the market have anti-corrosion and anti-rust properties. When it is diluted excessively, it loses its anti-corrosion property. Dilute a permanent type of antifreeze in accordance with the instructions of the manufacturer.

NOTE

- *A permanent type of antifreeze is installed in the cooling system when shipped. It is colored green and contains ethylene glycol. It is mixed at 50% and has the freezing point of -35°C (-31°F).*

Coolant Level Inspection

- Position the motorcycle so that it is perpendicular to the ground.
- Remove the four bolts and fan cover.
- Check the coolant level with the coolant level lines on the reserve tank. The coolant level should be between the F (Full) and L (Low) level lines.

NOTE

- *Check the level when the engine is cold (room or atmospheric temperature).*
- *The reserve tank is located inside the left side cover.*

correct mixture ratio by the addition of antifreeze concentrate as soon as possible.

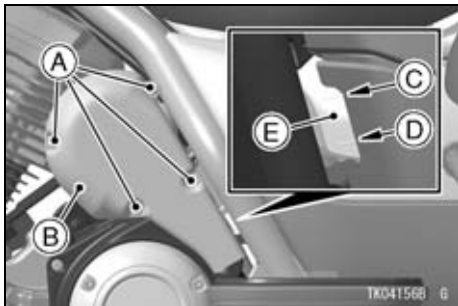

- A. Bolts
- B. Fan Cover
- C. F (Full) Level Line
- D. L (Low) Level Line
- E. Reserve Tank

- If the amount of coolant is insufficient, add coolant to the F (Full) level line (see Coolant Filling section).

NOTE

- *In an emergency you can add water alone to the coolant reserve tank, however it must be returned to the*

NOTICE

If coolant must be added often, or the reserve tank completely runs dry, there is probably leakage in the system. Have the cooling system inspected by your authorized Kawasaki dealer.

Coolant Filling

- Remove the rider's seat (see Seat section in the GENERAL INFORMATION).
- Unscrew the left side cover screw.
- Remove the left side cover by pulling out the upper part of the cover out slowly to detach the projections.

162 MAINTENANCE AND ADJUSTMENT

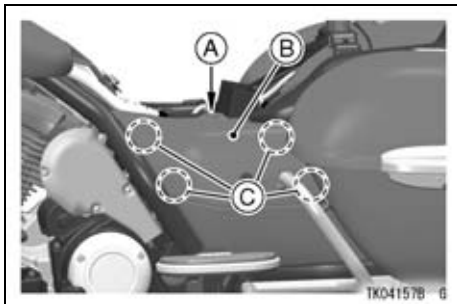

- A. Left Side Cover Screw
- B. Left Side Cover
- C. Projections

- Remove the cap from the reserve tank and add coolant through the filler opening to the F (Full) level line.

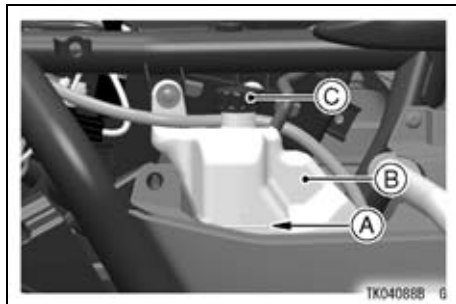

- A. F (Full) Level Line
- B. Reserve Tank
- C. Reserve Tank Cap

- Install the cap after filling coolant.
- When installing the left side cover, be sure to insert the projections of the left side cover to each holes.

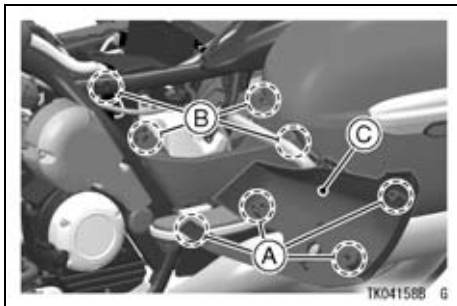

- A. Projections
- B. Holes
- C. Left Side Cover

- Install the removed parts.

Coolant Change

Have the coolant changed by an authorized Kawasaki dealer.

Drive Belt

In order for the belt and belt pulleys to function properly, check the drive belt in accordance with the Periodic Maintenance Chart.

Belt check and adjustment should be done by an authorized Kawasaki dealer.

NOTICE

Improper drive belt deflection can result in belt damage.

164 MAINTENANCE AND ADJUSTMENT

Spark Plugs

The standard spark plug is shown in the table. The spark plugs check and replacement should be done only by a competent mechanic following the instructions in the Service Manual.

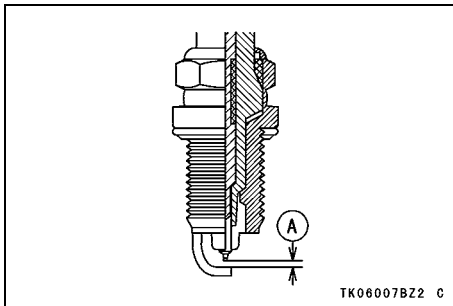

A. 1.0 ~ 1.1 mm (0.039 ~ 0.043 in.)

Spark Plug

Standard Plug	NGK ILZKAR7B11
Plug Gap	1.0 ~ 1.1 mm (0.039 ~ 0.043 in.)
Tightening Torque	18 N·m (1.8 kgf·m, 13 ft·lb)

NOTE

- Fit the plug cap securely onto the spark plug, and pull the cap lightly to make sure that it is properly installed.

Evaporative Emission Control System (California model only)

This system routes fuel vapors from the fuel system into the running engine or stores the vapors in a canister when the engine is stopped. Although no adjustments are required, a thorough visual inspection must be made at the intervals specified by the Periodic Maintenance Chart.

Inspection

- Check that the hoses are securely connected.
- Replace any kinked, deteriorated, or damaged hoses.

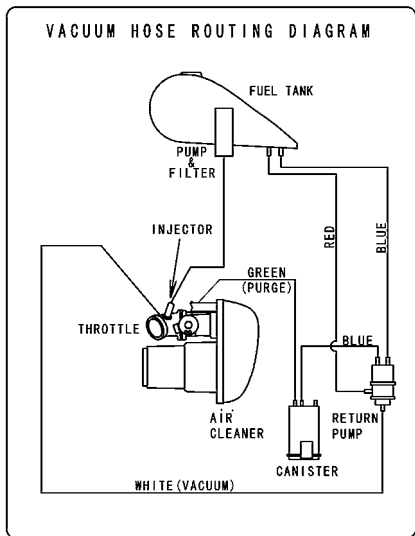

Valve Clearance

Valve and valve seat wear is automatically compensated for the valve clearance. So inspection and adjustment of the valve clearance are not necessary on this motorcycle.

Kawasaki Clean Air System

The Kawasaki Clean Air System (KCA) is a secondary air suction system that helps the exhaust gases to burn more completely. When the spent fuel charge is released into the exhaust system, it is still hot enough to burn. The KCA System allows extra air into the exhaust system so that the spent fuel charge can continue to burn. This continued burning action tends to burn up a great deal of the normally unburned gases, as well as changing a significant portion of the carbon monoxide into carbon dioxide.

Air Suction Valves -

The air suction valve is essentially a check valve which allows fresh air to flow only from the air cleaner into the exhaust port. Any air that has passed the air suction valve is prevented from returning. Inspect the air suction valves in accordance with the Periodic Maintenance Chart. Also, inspect the air suction valves whenever stable idling cannot be obtained, engine power is greatly reduced, or there is abnormal engine noise.

Air suction valve removal and inspection should be done only by a competent mechanic following the instructions in the Service Manual.

Air Cleaner

A clogged air cleaner restricts the engine's air intake, increasing fuel consumption, reducing engine power, and causing spark plug fouling.

The air cleaner element must be replaced in accordance with the Periodic Maintenance Chart. This motorcycle's air cleaner element consists of a wet paper filter, which cannot be cleaned. In dusty, rainy, or on muddy conditions, the air cleaner element should be serviced more frequently than the recommended interval.

NOTICE

Use only the recommended air cleaner element (Kawasaki part number 11013-0031). Using the any other air cleaner element will wear the engine prematurely or lower the engine performance.

168 MAINTENANCE AND ADJUSTMENT

Element Removal

- Remove the bolts of the air cleaner cover located on the left-side of the engine.

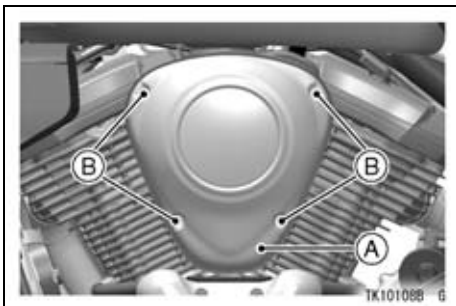

A. Air Cleaner Cover
B. Bolts

- Remove the air cleaner screw and the air cleaner. If any part of the element is damaged, the element must be replaced.

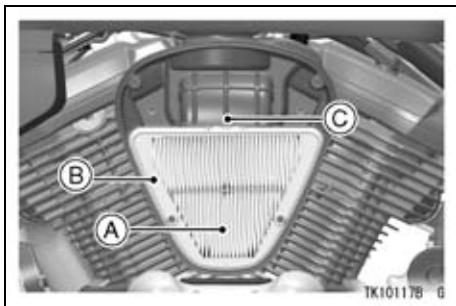

A. Air Cleaner Element
B. Air Cleaner
C. Screw

 **WARNING**

If dirt or dust is allowed to pass through into the fuel injection system, the throttle may stick or become inoperable resulting in a hazardous operating condition.

NOTICE

If dirt gets through into the engine, excessive engine wear and possibly engine damage will occur.

NOTE

- *Element installation is performed in the reverse order of removal.*

Throttle Control System

Check the throttle grip play in accordance with the Periodic Maintenance Chart, and adjust it if necessary.

Adjustment should be done by an authorized Kawasaki dealer.

Throttle Grip -

The throttle grip controls the butterfly valves in the throttle body. If the throttle grip has excessive play due to either cable stretch or maladjustment, it will cause a delay in throttle response, especially at low engine speed. Also, the throttle valve may not open fully at full throttle. On the other hand, if the throttle grip has no play, the throttle will be hard to control, and idle speed will be erratic.

170 MAINTENANCE AND ADJUSTMENT

Inspection

- Check that there is 2 ~ 3 mm (0.08 ~ 0.12 in.) throttle grip play when lightly turning the throttle grip back and forth.

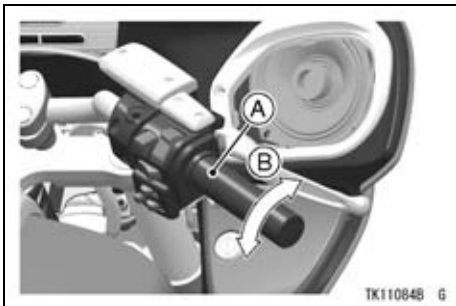

A. Throttle Grip

B. 2 ~ 3 mm (0.08 ~ 0.12 in.)

⚠ WARNING

Operation with improperly adjusted, incorrectly routed, or damaged cables could result in an unsafe riding condition. Be sure the control cables are adjusted and routed correctly, and are free from damage.

Idle Speed

The idle speed adjustment should be performed in accordance with the Periodic Maintenance Chart or whenever the idle speed is disturbed. The following procedure covers the idle speed adjustment.

Idle Speed

950 ±50 r/min (rpm)

Adjustment

ETV controls the idle speed preset in accordance with following procedure. If necessary change the idle speed to meet the factory specified range.

- Shift the transmission into neutral.
- Start the engine, and warm it up thoroughly.
- Push the “S” button for more than two seconds to display the unit setting menu.
- Push the “S” button to display the idle speed adjusting mode.

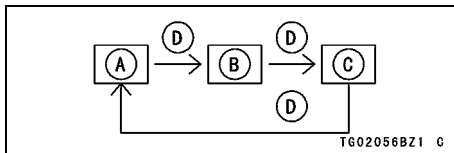

- A. Clock Adjusting Mode
- B. Distance Unit Setting Mode
- C. Idle Speed Adjusting Mode
- D. Push “S” Button

NOTE

- Without having the engine started, the idle speed adjusting mode is not displayed.

172 MAINTENANCE AND ADJUSTMENT

○ When the coolant temperature is low, the idle speed adjusting mode is sometimes not displayed. In that case, warm up the engine thoroughly first, and then push the “S” button again to display the idle speed adjusting mode.

- Adjust the idle speed by pushing the “MODE-A” or “MODE-B” switches.
- The idle speed goes up 50 r/min (rpm) at one time by pushing the “MODE-A” switch, and goes down 50 r/min (rpm) at one time by pushing the “MODE-B” switch.

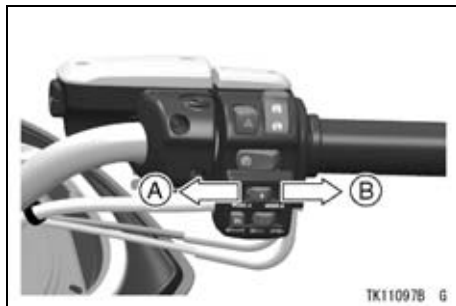

- A. “MODE-A” Switch
- B. “MODE-B” Switch

Idle Speed Adjusting Range

850 ~ 1 100 r/min (rpm)

NOTE

- The initial setting idle speed is 950 r/min (rpm).
- The numerical values on the display show the difference between the actual idle speed and the initial setting idle speed. The numerical values "+100" shown on the display as below indicate the actual idle speed "1 050 rpm".



A.1 050 r/min (rpm)

- Push the "MODE-B" switch for more than two seconds to return the idle speed to the initial setting.
- Push the "S" button to return to the unit setting menu.
- Open and close the throttle a few times to make sure that the idle speed does not change. Readjust if necessary.
- With the engine idling, turn the handlebar to each side. If handlebar movement changes the idle speed, the throttle cables may be improperly adjusted or incorrectly routed, or they may be damaged. Be sure to correct any of these conditions before riding.

WARNING

Operation with damaged cables could result in an unsafe riding condition. Replace damaged control cables before operation.

Clutch

The motorcycle is equipped with a hydraulically operated clutch that requires no adjustment except fluid level and clutch operation inspection each day before riding the motorcycle in accordance with the Periodic Maintenance Chart.

Clutch Operation Inspect

- If the clutch lever play becomes excessive and the motorcycle creeps or stalls when shifted into gear, there is probably air in the clutch system and it must be bled out by an authorized Kawasaki dealer.

Fluid Level Inspection

- With the clutch fluid reservoir held horizontal, the clutch fluid level must be kept above lower level lines, next to the gauge.

- If the clutch fluid level is lower than the lower level line, check for fluid leaks in the clutch line, and fill the clutch fluid reservoir to the upper level line.

NOTE

- *Use the same fluid as is used in the brakes and keep the same requirements mentioned in the "Brakes" section.*

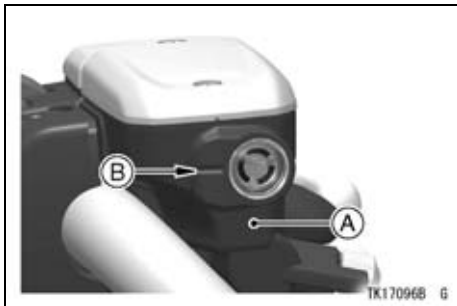

- A. Clutch Fluid Reservoir
- B. Lower Level Line

Brakes

Brake Wear Inspection

Inspect the brakes for wear. For each front and rear disc brake caliper, if the thickness of either pad is less than 1 mm (0.04 in), replace both pads in the caliper as a set. Pad replacement should be done by an authorized Kawasaki dealer.

NOTE

- *As for the motorcycle equipped with K-ACT ABS, the degree of wear of the front brake pad differs between the right and left calipers. Be sure to inspect both front brake pads in the right and left calipers for wear at the same time.*

176 MAINTENANCE AND ADJUSTMENT

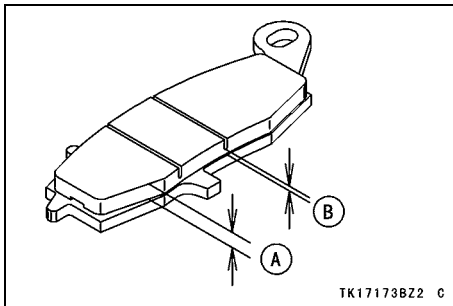

- A. Lining Thickness
- B. 1 mm (0.04 in.)

Brake Fluid -

In accordance with the Periodic Maintenance Chart, inspect the brake fluid level in both the front and rear brake fluid reservoirs and change the brake

fluid. The brake fluid should also be changed if it becomes contaminated with dirt or water.

Fluid Requirement

Use heavy-duty brake fluid only from a container marked DOT4 .

NOTICE

Do not spill brake fluid onto any painted surface.

Do not use fluid from a container that has been left open or that has been unsealed for a long time.

Check for fluid leakage around the fittings.

Check brake hose for damage.

Fluid Level Inspection

- The brake fluid level in the front brake fluid reservoir must be kept above the line (lower level line) next to the gauge and that in the rear brake fluid reservoir (located near the brake pedal) must be kept between the upper and lower level lines (reservoirs held horizontal).

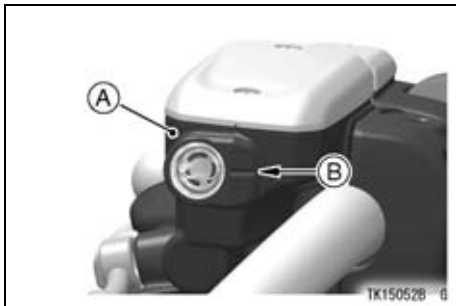

A. Front Brake Fluid Reservoir
B. Lower Level Line

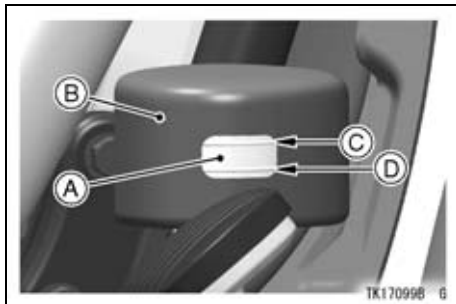

A. Rear Brake Fluid Reservoir
B. Cover
C. Upper Level Line
D. Lower Level Line

- If the fluid level in either reservoir is lower than the lower level line, check for fluid leaks in the brake lines, and fill the reservoir to the upper level line. Inside the front brake fluid reservoir is a stepped line showing the upper level line. For the rear reservoir, take off the bolt and remove the cover from the reservoir.

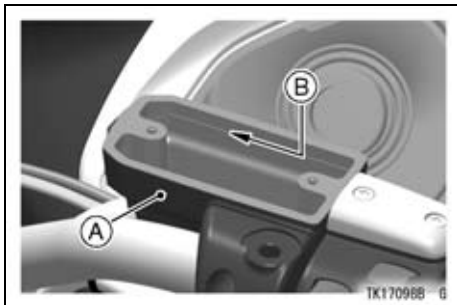

- A. Front Brake Fluid Reservoir
- B. Upper Level Line

NOTE

- *First, tighten until slight resistance is felt, with indicates that the cap is seated on the reservoir body, and then, tighten the cap an additional 1/6 turn while holding the brake fluid reservoir body.*



- A. Reservoir
- B. Cap
- C. Clockwise
- D. 1/6 Turn

 **WARNING**

Mixing brands and types of brake fluid can reduce the brake system's effectiveness and cause an accident resulting in injury or death. Do not mix two brands of brake fluid. Change the brake fluid in the brake line completely if the brake fluid must be refilled but the type and brand of the brake fluid that is already in the reservoir are unidentified.

Fluid Change

Have the brake fluid changed by an authorized Kawasaki dealer.

Front and Rear Brakes -

Disc and disc pad wear is automatically compensated for and has no effect on the brake lever or pedal action. So there are no parts that require adjustment on the front and rear brakes.

 **WARNING**

Air in brake line can make the brake feel mushy or soft. This may cause reduced braking performance or brake failure and result in an accident. If brake lever travel is excessive or the brake feels mushy, have an authorized Kawasaki dealer inspect it immediately.

Brake Light Switches

When either the front or rear brake is applied, the brake light goes on. The front brake light switch requires no adjustment, but the rear brake light switch should be adjusted in accordance with the Periodic Maintenance Chart.

Inspection

- Turn the ignition key to “ON”.
- The brake light should go on when the front brake is applied.
- If it does not, ask an authorized Kawasaki dealer to inspect the front brake light switch.
- Check the operation of the rear brake light switch by depressing the brake pedal. The brake light should go on after the proper pedal travel.

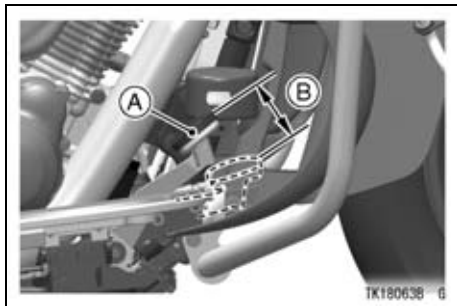

- A. Brake Pedal**
B. 10 mm (0.4 in.)

- If the light does not go on, adjust the rear brake light switch.

Brake Pedal Travel

10 mm (0.4 in.)

Adjustment

- To adjust the rear brake light switch, move the switch up or down by turning the adjusting nut.

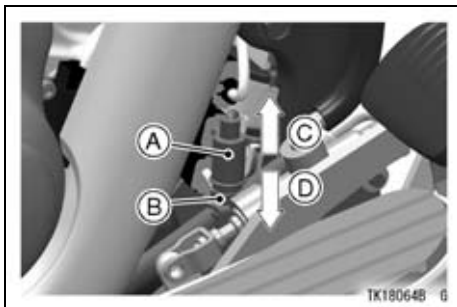

- A. Rear Brake Light Switch
- B. Adjusting Nut
- C. Lights Sooner.
- D. Lights Later.

NOTICE

To avoid damaging the electrical connections inside the switch, be sure that the switch body does not turn during adjustment.

Rear Shock Absorbers

The rear shock absorbers can be adjusted by changing the air pressure and rebound damping force to suit various riding and loading conditions.

Before making any adjustments, however, read the following procedures:

Air Pressure

The air pressure in the rear shock absorber can be adjusted for different roads and loading conditions.

The following table shows an example of air pressure adjustment. To obtain stable handling and a suitable ride, adjust the air pressure as indicated. The standard air pressure for an average-build rider of 68 kg (150 lb) with no passenger and no accessories is atmospheric pressure. Ordinarily, the heavier the total load becomes, the higher the air pressure should be set.

Air Pressure Adjustment

Air Pressure	Setting	Load	Road
Atmospheric Pressure	Soft	Light	Good
↓	↕	↕	↕
290 kPa (3.0 kg/cm ² , 43 psi)	Hard	Heavy	Bad

To adjust the air pressure

NOTE

- *Check and adjust the air pressure when the rear shock absorbers are cold (room temperature).*
- Raise the rear wheel off the ground by using a suitable jack.
- Take off the air valve caps on the left and right shock absorbers.

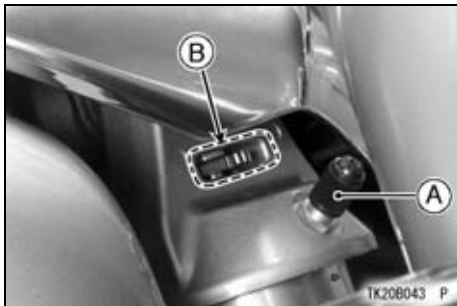

- A. Air Valve
- B. Rebound Damping Force Adjuster

- Check the air pressure with the air pressure gauge.

NOTE

- *Do not use tire gauges for checking air pressure. They may not indicate the correct air pressure because of air leaks that occur when the gauge is applied to the valve.*

- To lower the air pressure, push the valve core slightly. To raise the pressure, inject air through the valve with a tire pump. Change the air pressure within the range specified in the preceding table to suit various riding conditions.

NOTICE

Inject air little by little so that air pressure does not rise rapidly. Air pressure exceeding 290 kPa (3.0 kg/cm², 43 psi) may damage the oil seal.

Try to set the air pressure of the left and right shock absorbers as equally as possible.

 **WARNING**

Excessively high or low air pressure can adversely affect handling, creating the potential for a crash resulting in serious injury or death. Be sure to adjust the air pressure within the specified range. Only use compressed air or nitrogen gas for filling the shocks. Under normal use heat is generated within the shock, so never use oxygen or any other kind of explosive gas to prevent the possibility of explosion. Do not incinerate the rear shock absorber since it may explode.

Rebound Damping Force

The rebound damping force adjuster on each rear shock absorber has 4 positions so that the rebound damping force can be adjusted for different roads and loading conditions. The numbers on the adjuster show the setting position.

The following table shows an example of damping force adjustment. To obtain stable handling and a suitable ride, adjust the damping force as indicated. The damping force can be left soft for average riding. But it should be adjusted harder for high speed riding or riding with a passenger. If the damping feels too soft or too stiff, adjust it in accordance with the following table.

The standard setting position under the same conditions as in air pressure adjustment is No.II.

To adjust the damping force:

- Turn the adjusters to the desired position until you feel a click.
- Check to see that both adjusters are turned to the same relative position.

WARNING

If both damping force adjusters are not adjusted equally, handling may be impaired and a hazardous condition may result. Set all suspension adjusters equally to the recommended settings.

Rebound Damping Force Adjustment

Adjuster Position	Damping Force	Setting	Load	Road	Speed
I	↓	Soft	Light	Good	Low
II		↕	↕	↕	↕
III					
IIII					

Wheels

Tubeless tires are installed on the wheels of this motorcycle. The indications of TUBELESS on the tire side wall and the rim show that the tire and rim are specially designed for tubeless use.

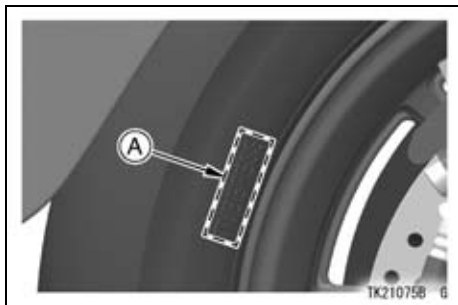

A. TUBELESS Mark

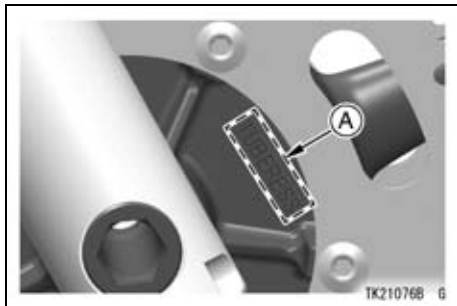

A. TUBELESS Mark

The tire and rim form a leakproof unit by making airtight contacts at the tire chamfers and the rim flanges instead of using an inner tube.

 **WARNING**

Installing a tube inside a tubeless-type tire can create excessive heat build up that can damage the tube and cause rapid deflation. The tires, rims, and air valves on this motorcycle are designed only for tubeless type wheels. The recommended standard tires, rims, and air valves must be used for replacement. Do not install tube-type tires on tubeless rims. The beads may not seat properly on the rim causing tire deflation. Do not install a tube inside a tubeless tire. Excessive heat build-up may damage the tube causing tire deflation.

Tires -*Payload and Tire Pressure*

Failure to maintain proper inflation pressures or observe payload limits for your tires may adversely affect handling and performance of your motorcycle and can result in loss of control. The maximum recommended load in addition to vehicle weight is 180 kg (397 lb), including rider, passenger, baggage, and accessories.

188 MAINTENANCE AND ADJUSTMENT

- Remove the air valve cap.
- Check the tire pressure often, using an accurate gauge.
- Make sure that the air valve cap is securely installed.

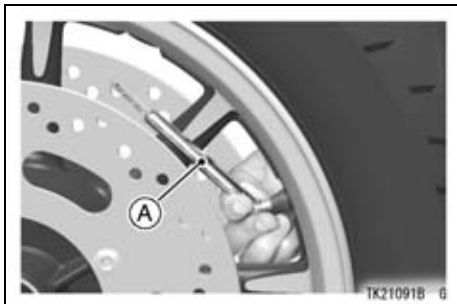

A. Tire Pressure Gauge

NOTE

- *Measure the tire pressure when the tires are cold (that is, when the motorcycle has not been ridden more than a mile during the past 3 hours).*
- *Tire pressure is affected by changes in ambient temperature and altitude, and so the tire pressure should be checked and adjusted when your riding involves wide variations in temperature or altitude.*

Tire Air Pressure (when cold)

Front	Up to 180 kg (397 lb) Load	200 kPa (2.00 kgf/cm ² , 28 psi)
Rear	Up to 97.5 kg (215 lb) Load	250 kPa (2.50 kgf/cm ² , 36 psi)
	97.5 ~ 180 kg (215 ~ 397 lb) Load	280 kPa (2.80 kgf/cm ² , 40 psi)

Tire Wear, Damage

As the tire tread wears down, the tire becomes more susceptible to puncture and failure. An accepted estimate is that 90% of all tire failures occur during the last 10% of tread life (90% worn). So it is false economy and unsafe to use the tires until they are bald.

- In accordance with the Periodic Maintenance Chart, measure the depth of the tread with a depth gauge, and replace any tire that has worn down to the minimum allowable tread depth.

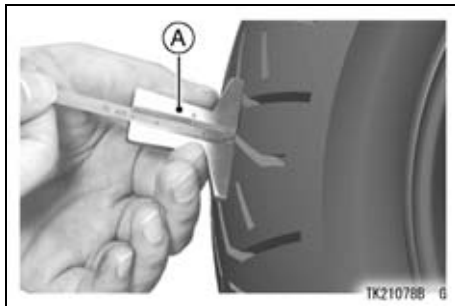

A. Tire Depth Gauge

190 MAINTENANCE AND ADJUSTMENT

Minimum Tread Depth

Front	_____	1 mm (0.04 in.)
Rear	Under 130 km/h (80 mph)	2 mm (0.08 in.)
	Over 130 km/h (80 mph)	3 mm (0.12 in.)

- Visually inspect the tire for cracks and cuts, replacing the tire in case of bad damage. Swelling or high spots indicate internal damage, requiring tire replacement.
- Remove any imbedded stones or other foreign particles from the tread.

NOTE

- *Have the wheel balance inspected whenever a new tire is installed.*

WARNING

Tires that have been punctured and repaired do not have the same capabilities as undamaged tires and can suddenly fail, causing an accident resulting in serious injury or death. Replace damaged tires as soon as possible. To ensure safe handling and stability, use only the recommended standard tires for replacement, inflated to the standard pressure. If it is necessary to ride on a repaired tire, do not exceed 100 km/h (60 mph) until the tire is replaced.

NOTE

- *When operating on public roadways, keep maximum speed under traffic law limits.*

Standard Tire (Tubeless)

Front	Make, Type: BRIDGESTONE EXEDRA G721 E Size: 130/90B16M/C 67H
Rear	Make, Type: BRIDGESTONE EXEDRA G722 E Size: 170/70B16M/C 75H

 **WARNING**

Mixing tire brands and types can adversely affect handling and cause an accident resulting in injury or death. Always use the same manufacturer's tires on both front and rear wheels.

 **WARNING**

New tires are slippery and may cause loss of control and injury. A break-in period of 160 km (100 miles) is necessary to establish normal tire traction. During break-in, avoid sudden and maximum braking and acceleration, and hard cornering.

Battery

The battery installed in this vehicle is a sealed type, and the sealing strip should not be removed at any time after the specified electrolyte has been installed in the battery for initial service. It is not necessary to check the battery electrolyte level or add distilled water.

However, in order to maximize battery life and ensure that it will provide the power needed to start the motorcycle you must properly maintain the battery's charge. When used regularly, the charging system in the motorcycle helps keep the battery fully charged. If the motorcycle is only used occasionally or for short periods of time, the battery is more likely to discharge.

Due to their internal composition, batteries continually self discharge. The discharge rate depends on the type of battery and ambient temperature. As temperatures rise, so does the discharge rate. Every 15°C (59°F) doubles the rate.

Electrical accessories, such as digital clocks and computer memory, also draw current from the battery even when the key is switched off. Due to a combination of such "key-off" draws with hot temperature, a battery can go from fully charged to completely discharged in a matter of days.

Self-discharge		
Temperature	Approx. number of days from 100% charged to 100% discharged	
	Lead -Antimony	Lead -Calcium
	Battery	Battery
40°C (104°F)	100 Days	300 Days
25°C (77°F)	200 Days	600 Days
0°C (32°F)	550 Days	950 Days

Current Drain		
Dis-charging Ampere	Days from 100% Charged to 50% discharged	Days from 100 % Charged to 100 % discharged
7 mA	60 Days	119 Days
10 mA	42 Days	83 Days
15 mA	28 Days	56 Days
20 mA	21 Days	42 Days
30 mA	14 Days	28 Days

In extremely cold weather the fluid in an inadequately charged battery can easily freeze, which can crack the case and buckle the plates. A fully charged battery can withstand sub-freezing temperatures with no damage.

Battery Sulfation

A common cause of battery failure is sulfation.

Sulfation occurs when the battery is left in a discharged condition for an extended time. Sulfate is a normal by product of the chemical reactions within a battery. But when continuous discharge allows the sulfate to crystallize in the cells, the battery plates become permanently damaged and will not hold a charge. Battery failure due to sulfation is not warrantable.

Battery Maintenance

It is the owner's responsibility to keep the battery fully charged. Failure to do so can lead to battery failure and leave you stranded.

If you are riding your vehicle infrequently, inspect the battery voltage weekly using a voltmeter. If it drops

below 12.6 volts, the battery should be charged using an appropriate charger (check with a Kawasaki dealer). If you will not be using the motorcycle for longer than two weeks, the battery should be charged using an appropriate charger. Do not use an automotive-type quick charger that may overcharge the battery and damage it.

NOTE

- *Leaving the battery connected causes the electrical components (clock etc) to make the battery discharged, resulting the over discharge of the battery. In this case, the repair or replacement of the battery is not included in the warranty. If you do not drive for four weeks or more, disconnect the battery from the vehicle.*

Kawasaki-recommended chargers are

Battery Mate 150-9

OptiMate 4

Yuasa MB-2040/2060

Christie C10122S

If the above chargers are not available, use equivalent one.

For more details, ask a Kawasaki dealer.

Battery Charging

- Remove the battery from the motorcycle (see Battery Removal).
- Attach the leads from the charger and charge the battery at a rate (amperage × hours) that is indicated on the battery. If it is not possible to read the rate, charge the battery at an amperage that is about 1/10th of the battery capacity.

- The charger will keep the battery fully charged until you are ready to re-install the battery in the motorcycle (see Battery Installation).

NOTICE

Never remove the sealing stirp, or the battery can be damaged. Do not install a conventional battery in this vehicle, or the electrical system cannot work properly.

Make	Furukawa Battery
Type	FTZ16-BS

NOTE

- *If you charge the sealed battery, never fail to observe the instructions shown on the label on the battery.*

⚠ WARNING

Battery posts, terminals and related accessories contain lead and lead compounds, chemicals known to the State of California to cause cancer and reproductive harm. Wash hands after handling.

Battery Removal

- Remove the rider's seat (see Seat section in the GENERAL INFORMATION chapter).
- Remove the connector from the battery case cover.
- Unscrew the battery case cover screws, and then remove the battery case cover.

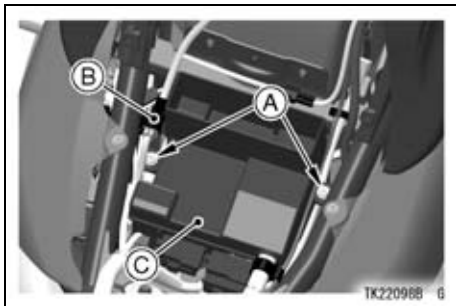

- A. Battery Case Cover Screws**
- B. Connector**
- C. Battery Case Cover**

- Remove the (-) terminal bolt, and then disconnect the (-) cable from the (-) terminal.
- Remove the red cap.

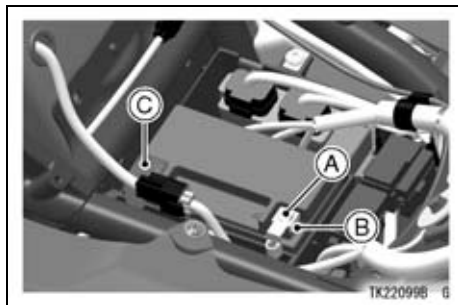

- A. (-) Terminal Bolt
- B. (-) Terminal
- C. Red Cap

- Remove the (+) terminal bolt, and then disconnect (+) cable from the (+) terminal.

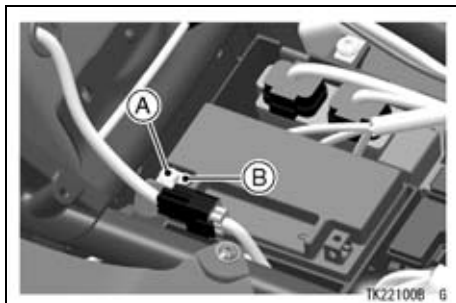

- A. (+) Terminal Bolt
- B. (+) Terminal

NOTICE

Do not remove the battery and fuse for 6 seconds after turning off the ignition switch.

198 MAINTENANCE AND ADJUSTMENT

- Clean the battery using a solution of baking soda and water. Be sure that the cable connections are clean.

Battery Installation

- Connect the (+) cable into the (+) terminal, and then tighten the (+) terminal bolt into the (+) terminal.
- Connect the (-) cable into the (-) terminal, and then tighten the (-) terminal bolt into the (-) terminal.

NOTICE

Installing the (-) cable to the (+) terminal of the battery or the (+) cable to the (-) terminal of the battery can seriously damage the electrical system.

NOTE

- *When installing the battery, the speedometer needle may momentarily point to the last reading. If the battery is disconnected while the meter needle is moving, the needle will stop on its way, but will normally return when the battery is connected again.*
- Put a light coat of grease on the terminals to prevent corrosion.
- Cover the terminals with its protective cap.
- Install the battery case cover, and tighten the battery case cover screws.
- Reinstall the removed parts.

Headlight Beam

Horizontal Adjustment

The headlight beam is adjustable horizontally. If not properly adjusted horizontally, the beam will point to one side rather than straight ahead.

- Turn the horizontal adjusting screw on the headlight rim in or out until the beam points straight ahead.

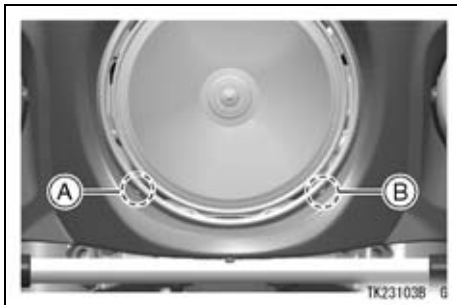

A. Horizontal Adjusting Screw
B. Vertical Adjusting Screw

Vertical Adjustment

The headlight beam is adjustable vertically. If adjusted too low, neither low nor high beam will illuminate the road far enough ahead. If adjusted too high, the high beam will fail to illuminate the road close ahead, and the low beam will blind oncoming drivers.

- Turn the vertical adjusting screw on the headlight rim in or out to adjust the headlight vertically.

NOTE

- *On high beam, the brightest point should be slightly below horizontal. The proper angle is 0.4 degrees below horizontal. This is a 50 mm (2.0 in.) drop at 7.6 m (25 ft) measured from the center of the headlight, with the motorcycle on its wheels and the rider seated.*

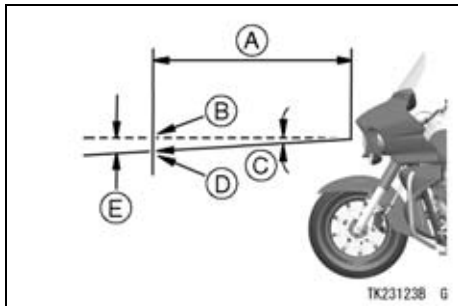

- A. 7.6 m (25 ft)
- B. Height of Headlight Center
- C. 0.4 degrees
- D. Center of Brightest Spot
- E. 50 mm (2.0 in.)

Fuses

Fuses are arranged in the fuse box and the fuses located under the rider's seat. If a fuse fails during operation, inspect the electrical system to determine the cause, and then replace it with a new fuse of proper amperage.

The main fuse removal should be done by an authorized Kawasaki dealer.

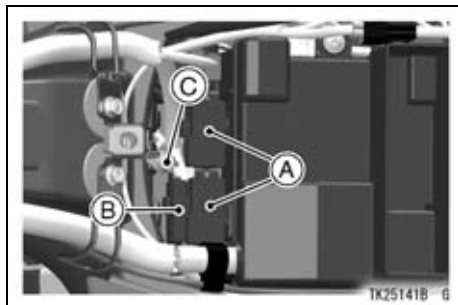

- A. Fuse Boxes
- B. Fuse Box (K-ACT ABS)
- C. Fuse Box (Fan Motor)

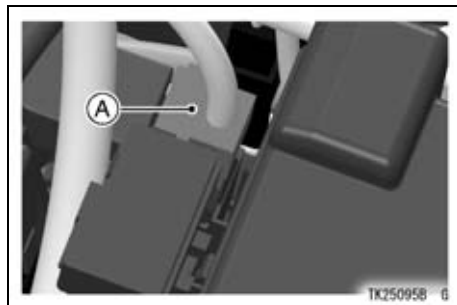

- A. Main Fuse

⚠ WARNING

Substituting fuses can cause wiring to overheat, catch fire and/or fail. Do not use any substitute for the standard fuse. Replace the blown fuse with a new one of the correct capacity, as specified on the junction box and main fuse.

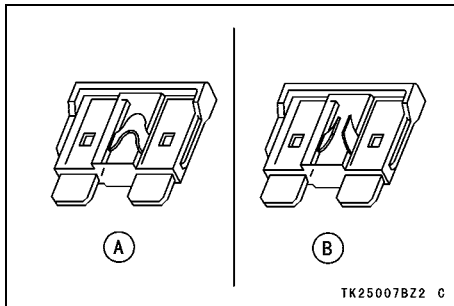

- A. Normal
B. Failed

NOTICE

Do not remove the battery and fuse for 6 seconds after turning off the ignition switch.

General Lubrication

Lubricate the points shown below, with either motor oil or regular grease, in accordance with the Periodic Maintenance Chart or whenever the vehicle has been operated under wet or rainy conditions.

Before lubricating each part, clean off any rusty spots with rust remover and wipe off any grease, oil, dirt, or grime.

NOTE

- A few drops of oil are effective to keep bolts and nuts from rusting and sticking. This makes removal easier. Badly rusted nuts, bolts, etc., should be replaced with new ones.

Apply motor oil to the following pivots -

- Side Stand
- Clutch Lever
- Front Brake Lever
- Rear Brake Pedal

Lubricate the following cables with a pressure cable luber -

- (K) Throttle Inner Cables

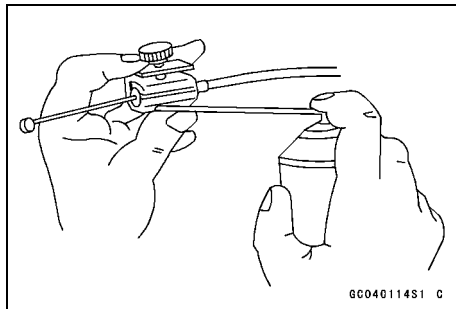

Apply grease to the following points-

- (K) Throttle Inner Cable Upper Ends
- (K): Should be serviced by an authorized Kawasaki dealer

NOTE

- *After connecting the cables, adjust them.*

Cleaning Your Motorcycle

General Precautions

Frequent and proper care of your Kawasaki motorcycle will enhance its appearance, optimize overall performance, and extend its useful life. Covering your motorcycle with a high quality, breathable motorcycle cover will help protect its finish from harmful UV rays, pollutants, and reduce the amount of dust reaching its surfaces.

WARNING

Build-up of debris or flammable material in and around the vehicle chassis, engine, and exhaust can cause mechanical problems and increase the risk of fire.

When operating the vehicle in conditions that allow debris or flammable material to collect in and around the vehicle, inspect the engine, electrical component and exhaust areas frequently. If debris or flammable materials have collected, park the vehicle outside and stop the engine. Allow the engine to cool, then remove any collected debris. Do not park or store the vehicle in an enclosed space prior to inspecting for build-up of debris or flammable materials.

- Be sure the engine and exhaust are cool before washing.
- Avoid applying degreaser to seals, brake pads, and tires.
- Always use non-abrasive wax and cleaner/polisher.
- Avoid all harsh chemicals, solvents, detergents, and household cleaning products such as ammonia-based window cleaners.
- Gasoline, brake fluid, and coolant will damage the finish of painted and plastic surfaces: wash them off immediately.
- Avoid wire brushes, steel wool, and all other abrasive pads or brushes.
- Use care when washing the windshield, headlight lens, and the plastic parts as they can easily be scratched.
- Avoid using pressure washers; water can penetrate seals and electrical components and damage your motorcycle.
- Avoid spraying water in delicate areas such as in air intakes, fuel system, brake components, electrical components, electrical socket, audio system muffler outlets, and fuel tank openings.
- After cleaning your motorcycle, check the rubber boot covering the shift pedal ball joint for correct installation. Be sure the sealing lip of the rubber boot fits into the groove of the ball joint.

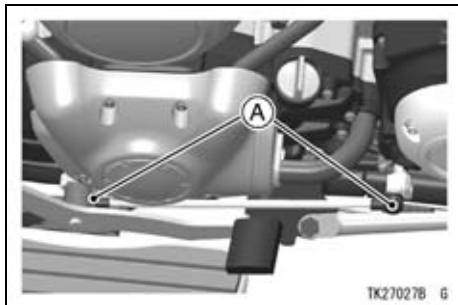

A. Rubber Boot

- If the boot is damaged, replace it with a new one. If the boot is not positioned in the groove correctly, replace it in the correct position.

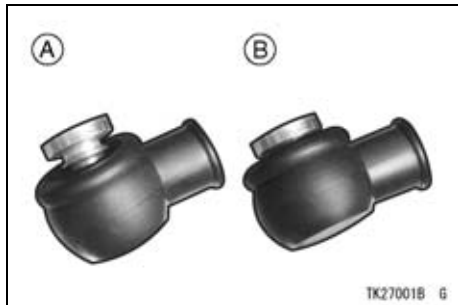

A. Not Position

B. Correct Position

Washing Your Motorcycle

- Rinse your bike with cold water from a garden hose to remove any loose dirt.
- Mix a mild neutral detergent (designed for motorcycles or automobiles) and water in bucket. Use a soft cloth or sponge to wash your

motorcycle. If needed, use a mild degreaser to remove any oil or grease build up.

- After washing, rinse your motorcycle thoroughly with clean water to remove any residue (residue from the detergent can damage parts of your motorcycle).
- Use a soft cloth to dry your motorcycle. As you dry, inspect your motorcycle for chips and scratches. Do not let the water air dry as this can damage the painted surfaces.
- Start the engine and let it idle for several minutes. The heat from the engine will help dry moist areas.
- Carefully ride your motorcycle at a slow speed and apply the brakes several times. This helps dry the brakes and restores them to normal operating performance.

NOTE

- *After riding in an area where the roads are salted or near the ocean, immediately wash your motorcycle with cold water. Do not use warm water as it accelerates the chemical reaction of the salt. After drying, apply a corrosion protection spray on all metal and chrome surfaces to prevent corrosion.*
- *Condensation may form on the inside of the headlight lens after riding in the rain or washing the motorcycle. To remove the moisture, start the engine and turn on the headlight. Gradually the condensation on the inside of the lens will clear off.*

Semi-gloss Finish

To clean the semi-gloss finish;

- When washing the motorcycle, always use a mild neutral detergent and water.

208 MAINTENANCE AND ADJUSTMENT

- The semi-gloss finish effect may be lost when the finish is excessively rubbed.
- If any doubt, consult an authorized Kawasaki dealer.

Painted Surfaces

After washing your motorcycle, coat painted surfaces, both metal and plastic, with a commercially available motorcycle/automotive wax. Wax should be applied once every three months or as conditions require. Avoid surfaces with “satin” or “flat” finishes. Always use nonabrasive products and apply them according to the instructions on the container.

Windshield and Other Plastic Parts

After washing use a soft cloth to dry plastic parts gently. When drying the windshield, headlight lens and

non-painted plastic parts, an approved use plastic cleaner/polisher product.

NOTICE

Plastic parts may deteriorate and break if they come in contact with chemical substances or household cleaning products such as gasoline, brake fluid, window cleaners, thread-locking agents, or other harsh chemicals. If a plastic part comes in contact with any harsh chemical substance, wash it off immediately with water and a mild neutral detergent, and then inspect for damage. Avoid using abrasive pads or brushes to clean plastic parts, as they will damage the part's finish.

Chrome and Aluminum

Chrome and uncoated aluminum parts can be treated with a chrome/aluminum polish. Coated aluminum should be washed with a mild neutral detergent and finished with a spray polish. Aluminum wheels, both painted and unpainted can be cleaned with special non-acid based wheel spray cleaners.

Leather, Vinyl, and Rubber

If your motorcycle has leather accessories, special care must be taken. Use a leather cleaner/treatment to clean and care for leather accessories. Washing leather parts with detergent and water will damage them, shortening their life.

Vinyl parts should be washed with the rest of the motorcycle, then treated with a vinyl treatment.

The sidewalls of tires and other rubber components should be treated with a rubber protectant to help prolong their useful life.

**WARNING**

Rubber protectants can be slippery and, if used on the tread area, cause loss of traction resulting in accident causing injury or death. Do not apply rubber protectant to any tread area.

Bolt and Nut Tightening

In accordance with the Periodic Maintenance Chart, it is very important to check the tightness of the bolts and nuts listed here. Also, check to see that each cotter pin is in place and in good condition. Please ask your authorized Kawasaki dealer for torque values.

1. Lever Holder Clamp Bolts
2. Front Fork Clamp Bolts
3. Handle Clamp Bolts
4. Steering Stem Head Nut
5. Brake Lever Holder Clamp Bolts
6. Handle Holder Nuts
7. Steering Stem Nut

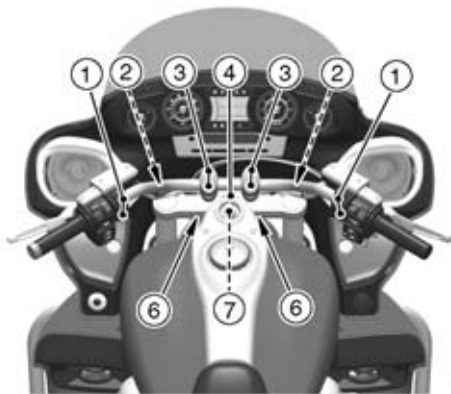

- 8. Front Fender Mounting Bolts
- 9. Engine Bracket Bolts
- 10. Trunk Stay Bolts
- 11. Front Axle Shaft
- 12. Brake Disk Mounting Bolts
- 13. Caliper Mounting Bolts
- 14. Cross Pipe Bolts
- 15. Footboard Mounting Bolts
- 16. Side Stand Nut
- 17. Engine Mounting Nuts
- 18. Saddlebag Stay Bolts
- 19. Rear Pulley Bolts

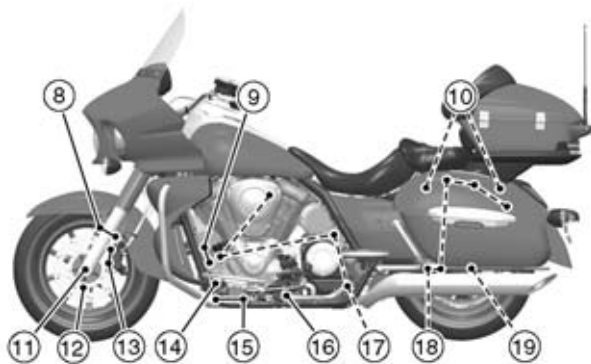

212 MAINTENANCE AND ADJUSTMENT

- 20. Rear Fender Mounting Bolts
- 21. Rear Shock Absorber Mounting Nuts
- 22. Muffler Mounting Bolts
- 23. Downtube Bolts
- 24. Rear Axle Nut
- 25. Rear Guard Mounting Bolts
- 26. Pivot Shaft Nut
- 27. Brake Pedal Mounting Bolt
- 28. Front Guard Mounting Bolts

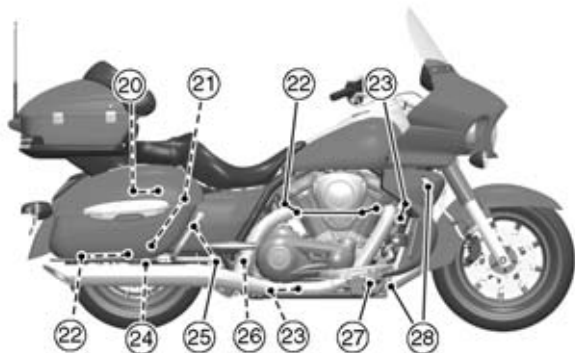

STORAGE

Preparation for Storage:

- Clean the entire vehicle thoroughly.
- Run the engine for about five minutes to warm the oil, shut it off and drain the engine oil.



WARNING

Engine oil is a toxic substance. Dispose of used oil properly. Contact your local authorities for approved disposal methods or possible recycling.

- Put in fresh engine oil.
- Empty the fuel from the fuel tank by the pump or siphon.

 **WARNING**

Gasoline is extremely flammable and can be explosive under certain conditions, creating the potential for serious burns. Turn the ignition key to “OFF”. Do not smoke. Make sure the area is well-ventilated and free from any source of flame or sparks; this includes any appliance with a pilot light. Gasoline is a toxic substance. Dispose of gasoline properly. Contact your local authorities for approved disposal methods.

- Empty the fuel system by running the engine at idle speed until all fuel in the fuel system is used up (If left in for a long time, the fuel will break down and clog the fuel system).
- Remove the spark plugs and spray fogging oil directly into each cylinder. Push the starter button for a few seconds to coat the cylinder walls. Install the spark plugs.

 **WARNING**

An air/oil mist may be forcibly ejected from the spark plug holes and could get into your eyes. Do not lean over the engine when performing this procedure. If you do get oil in your eyes, wash them immediately with liberal amounts of clean, fresh water and consult a physician as soon as possible.

- Reduce tire pressure by about 20%.
- Set the motorcycle on a box or stand so that both wheels are raised off the ground. (If this cannot be done, put boards under the front and rear wheels to keep dampness away from the tire rubber.)
- Spray oil on all unpainted metal surfaces to prevent rusting. Avoid getting oil on rubber parts or in the brakes.
- Lubricate all the cables.
- Remove the battery, and store it where it will not be exposed to direct sunlight, moisture, or freezing temperatures. During storage it should be given a slow charge (one ampere or less) about once a month. Keep the battery well charged especially during cold weather.
- Tie plastic bags over the mufflers to prevent moisture from entering.
- Put a cover over the motorcycle to prevent accumulation of dust and dirt.

Preparation after Storage:

- Remove the plastic bags from the mufflers.
- Install the battery in the motorcycle and charge the battery if necessary.
- Fill the fuel tank with fuel.
- Check all the points listed in the Daily Checks section.
- Lubricate the points listed in the General Lubrication section.

TROUBLESHOOTING GUIDE

Engine Does Not Start:

Starter Motor Won't Turn

- Engine stop switch off
- Transmission not in neutral
- Fuse blown
- Battery leads do not make good electrical contact with battery terminals
- Battery discharged

Engine Cranks, But Won't Start

- No fuel in tank
- Fuel line clogged
- Fuel broken down
- Engine flooded
- Spark plugs not in good contact
- Spark plugs fouled or wet

- Incorrect spark plug gap
- No first turning the ignition key to "OFF" when the motorcycle falls down.

Engine Stalls:

Just When Shifting Into 1st Gear

- Side stand has been left down
- Clutch does not properly disengage

While Riding

- No fuel in tank
- Fuel tank air vent is obstructed
- Overheating
- Battery discharged

YOUR WARRANTY/OWNER SATISFACTION

Welcome to the Kawasaki family!

Congratulations on buying your Kawasaki vehicle. You've chosen a great, high-quality product with state-of-the-art features and built to Kawasaki's high standards. Your satisfaction is important to your authorized Kawasaki dealer and to Kawasaki Motors Corp., U.S.A. Here is some important information regarding your vehicle's limited warranty.

Frequently Asked Questions

What is a Limited Warranty?

The most important thing to know about your warranty is that it protects you from manufacturing defects in material or workmanship during the warranty period. You can find the warranty period in the Kawasaki Limited Warranty Certificate your Kawasaki dealer provided to you at the time of sale. The warranty does not cover the cost of regularly-scheduled maintenance. The warranty also does not apply to the normal wear of items such as tires, brake pads, transmission drive belts, chains, sprockets, etc.

218 YOUR WARRANTY/OWNER SATISFACTION

What is the Good Times Protection Plan?

Much of the warranty coverage offered by the limited warranty can be extended by purchasing Kawasaki's Good Time™ Protection Plan (GTPP). See your Kawasaki dealer or go to Kawasaki.com for more information if you don't already have the GTPP.

What Am I Responsible For?

You are responsible for maintaining your vehicle according to the maintenance schedule shown in this owner's manual.

You are responsible for notifying your dealer immediately if there is a problem, and you, as the owner, will need to authorize the dealer to inspect the unit.

You will be responsible for paying for routine maintenance, including the first scheduled service. You can have the required servicing done by your Kawasaki dealer (recommended) or an equally-qualified service facility. You can also do your own maintenance work if you have the proper tools, service references, and mechanical skills. However, if a failure is found to be caused by improper servicing, it would not be covered by the limited warranty.

You may purchase a Kawasaki Service Manual and any necessary special tools directly from your Kawasaki dealer.

You will be responsible for paying for repairs needed because of an accident, to replace worn parts such as tires, chains, brakes, and for repairs needed because of a lack of maintenance, misuse or racing.

Whether you do it yourself or take your vehicle to a Kawasaki dealer, be sure to record your service in the Maintenance Record section of this Owner's Manual. Keep all receipts for the service and/or items necessary to perform the maintenance so that in the event of a failure you can document the service history.

What Are The Dealership's Responsibilities?

Your Kawasaki dealer offers a wide range of services, parts, accessories, and information on your product and on Kawasaki.

Each dealer is independently owned and operated and is responsible for the dealership's operations, its repair, warranty, and service work, and its personnel.

220 YOUR WARRANTY/OWNER SATISFACTION

Your dealer is responsible for completing the set up and pre-delivery service of your new Kawasaki vehicle. The dealership should also explain its operation, maintenance, and warranty provisions so you understand them at the time of purchase or at any other time you have questions.

The dealership is responsible for inspecting your Kawasaki vehicle if there is a failure, investigating the cause of the problem, and getting any needed authorization from Kawasaki if the repair is one that will be covered by the limited warranty. The dealership will also file all necessary paperwork. The dealership is responsible for correctly completing any necessary repairs, whether they are covered by the limited warranty or not.

How Do I Get Warranty Service?

If there is a problem with your vehicle within the limited warranty period, you will need to schedule a service appointment and provide any maintenance records to an authorized Kawasaki dealer for inspection and diagnosis. You can go to any Kawasaki dealer for warranty repairs. Your Kawasaki dealer will inspect your vehicle and give you the results of the inspection. The dealer will perform the repairs at no cost to you if it is determined that the problem is covered by the warranty.

Kawasaki will work with your dealer to resolve any warranty issues. No authorization for warranty work can be given until your vehicle has been inspected by a Kawasaki dealer.

What if I am not Satisfied With My Warranty Service?

If you aren't satisfied with your dealership's repair work or operations, it is best to discuss the situation with the appropriate dealership manager. If you have already done this, then contact the dealership's owner or general manager to request a review of the issue.

If you are unable to resolve a problem after consulting with the dealership management and need further assistance, contact Kawasaki Motors Corp., U.S.A. at the address below. Please be certain to provide the model, vehicle identification number (VIN), mileage or hours of use, accessories, dates that events occurred and what action has been taken by both you and your dealer. Include the name and address of the dealership. To assist us in resolving your inquiry, please include copies of related receipts and any other pertinent information including the name of the dealership personnel with whom you have been working. Upon receipt of your correspondence, Kawasaki Motors Corp., U.S.A. will contact the dealership and work with it in resolving your problem.

Want to Contact Kawasaki?

This owner's manual should answer most of your questions about your Kawasaki. Your Kawasaki dealer should either be able to answer any other questions you might have immediately or be able to find the answer for you.

Please send your correspondence to:

Consumer Services

Kawasaki Motors Corp., U.S.A.

P.O. Box 25252

Santa Ana, CA 92799-5252

(949) 460-5688

REPORTING SAFETY DEFECTS

(For Products Sold in the United States of America, District of Columbia, and U.S. Territories Only)

If you believe that your vehicle has a defect which could cause a crash or could cause injury or death, you should immediately inform the National Highway Traffic Safety Administration (NHTSA) in addition to notifying Kawasaki Motors Corporation, U.S.A.

If NHTSA receives similar complaints, it may open an investigation, and if it finds that a safety defect exists in a group of vehicles, it may order a recall and remedy campaign. However, NHTSA cannot become involved in individual problems between you, your dealer, or Kawasaki Motors Corporation, U.S.A.

To contact NHTSA, you may either call the Auto Safety Hotline toll-free at 1-800-424-9393 (or 366-0123 in Washington, D.C. area) or write to: NHTSA, U.S. Department of Transportation, Washington, D.C. 20590. You can also obtain other information about motor vehicle safety from the Hotline.

ENVIRONMENTAL PROTECTION

To help preserve the environment, properly discard used batteries, tires, oils and fluids, or other vehicle components that you might dispose of in the future. Consult your authorized Kawasaki dealer or local environmental waste agency for their proper disposal procedure. This also applies to disposal of the entire vehicle at the end of its life.

MAINTENANCE RECORD

Owner Name.....

Address

Phone Number

Engine Number

Vehicle Number.....

Key Code

Selling Dealer Name

Phone Number

Warranty Start Date

Note: Keep this information and a spare key in a secure location.

Date	Odometer Reading	Maintenance Performed	Dealer Name	Dealer Address

LOCATION OF LABELS

All warning labels which are on your vehicle are repeated here. Read labels on your vehicle and understand them thoroughly. They contain information which is important for your safety and the safety of anyone else who may operate your vehicle. Therefore, it is very important that all warning labels be on your vehicle in the locations shown. If any label is missing, damaged, or worn, get a replacement from your Kawasaki dealer and install it in the correct position.

NOTE

- *The sample warning labels in this section have part numbers to help you and your dealer obtain the correct replacement.*

- *Refer to the actual vehicle label for model specific data grayed out in the illustration.*



1. Clutch Fluid
2. Brake Fluid (Front)

230 LOCATION OF LABELS

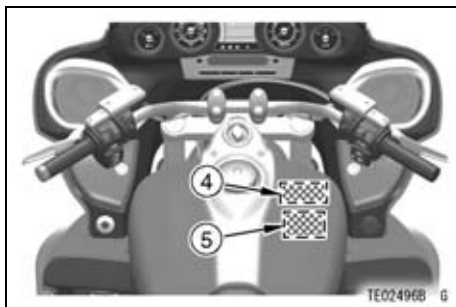
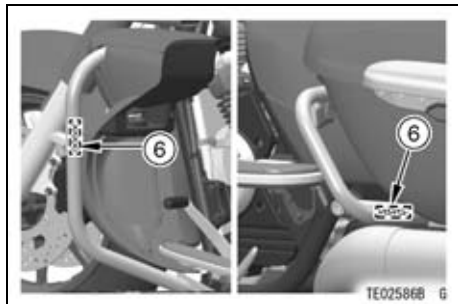
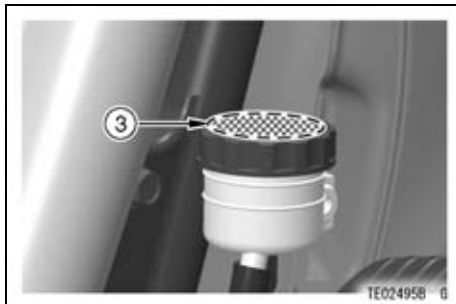

- 3. Brake Fluid (Rear)
- 4. Fuel Notice
- *5. Fuel Level
- 6. Engine Guard Warning

*: only on California model

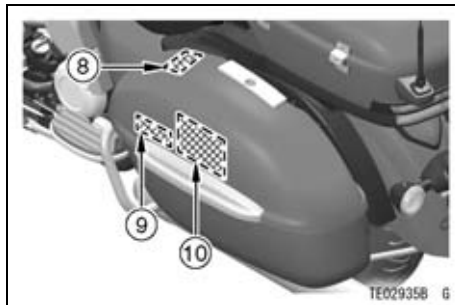
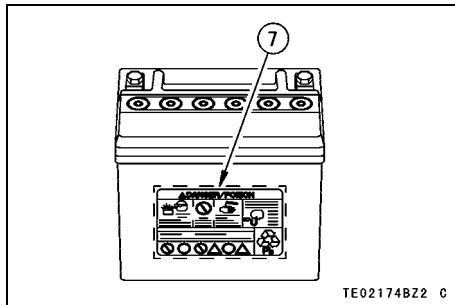

- 7. Battery Poison/Danger
- 8. Saddlebag Notice (Lid)
- 9. Saddlebag Notice (Bag)
- 10. Saddlebag Warning
- 11. Noise Emission Control Information

232 LOCATION OF LABELS

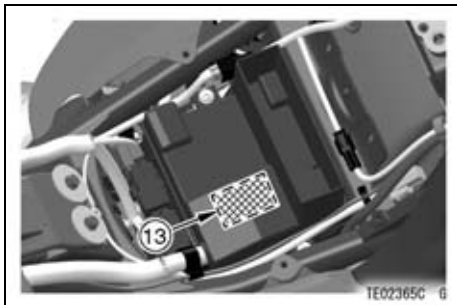
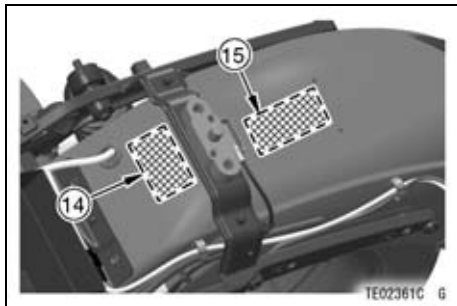
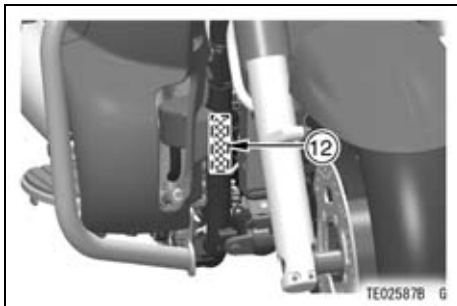

- 12. Weight and Manufacture
- *13. Vacuum Hose Routing Diagram
- 14. Vehicle Emission Control Information
- 15. Tire and Load Data

*: only on California model

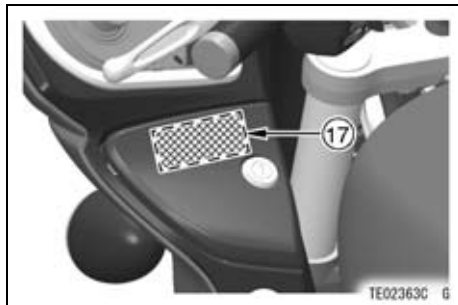
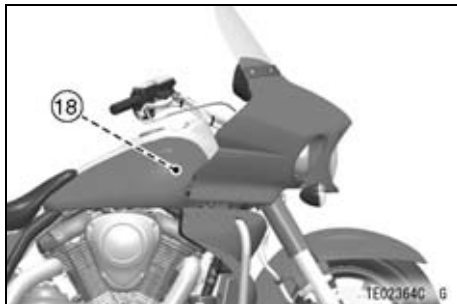
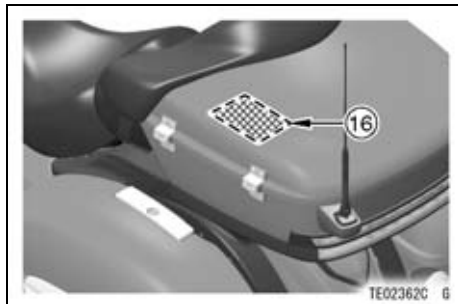

- 16. Trunk Warning
- 17. Fairing Pocket Notice (Both Sides)
- 18. Radiator Cap Danger

234 LOCATION OF LABELS

(1)

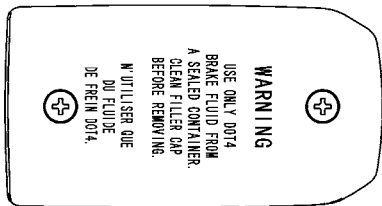

TE03088DZ2 C

(2)

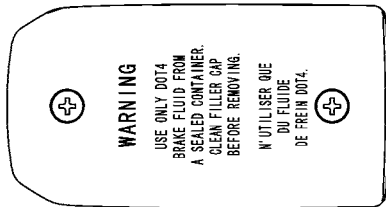

TE03089DZ2 C

(3)

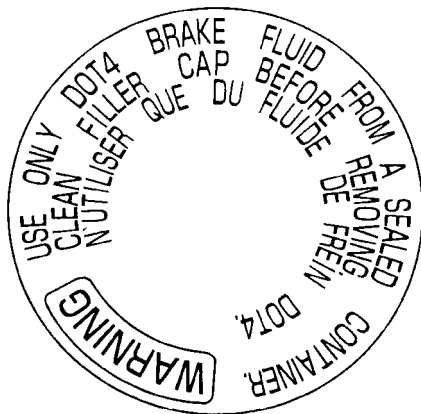

TE03097B S

(4)

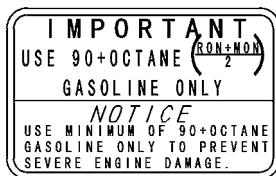

56030-0357

TE03172CN9 C

(5) Only on California model

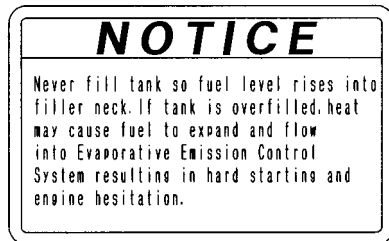

56071-0158

TE03715D S

236 LOCATION OF LABELS

(6)

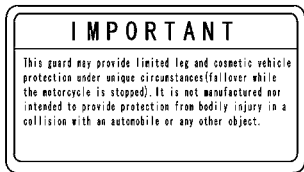

56070-1285

TE03432DN9 C

(7)

⚠ DANGER/POISON			
 <p>SHIELD EYES EXPLOSIVE GASES CAN CAUSE BLINDNESS OR INJURY</p>	 <p>NO • SPARKS • FLAMES • SMOKING</p>	 <p>SULFURIC ACID CAN CAUSE BLINDNESS OR SEVERE BURNS</p>	<p>FLUSH EYES IMMEDIATELY WITH WATER</p>  <p>GET MEDICAL HELP FAST</p>
KEEP OUT OF THE REACH OF CHILDREN.			
     			
<p>IN U.S.A., DISTR. BY KAWASAKI MOTORS CORP., USA P.O. BOX 25252 SANTA ANA, CA. 92799-5252</p>			CSO

238 LOCATION OF LABELS

(8)

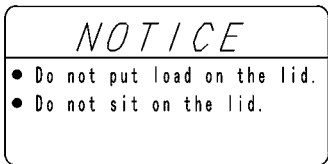

56071-0173

TE03268DN9 C

(9)



56071-0171

TE03766CN9 C

(10)

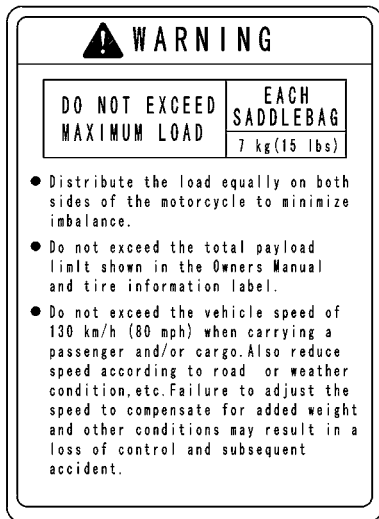

56070-1282

TE03422DN7 C

(11)

MOTORCYCLE NOISE EMISSION CONTROL INFO.

THIS [REDACTED] MOTORCYCLE MEETS EPA NOISE EMISSION REQUIREMENTS BY THE FEDERAL TEST PROCEDURE. MODIFICATIONS WHICH CAUSE THIS MOTORCYCLE TO EXCEED FEDERAL NOISE STANDARDS ARE PROHIBITED BY FEDERAL LAW. SEE OWNER'S MANUAL. ([REDACTED]) MODEL SPECIFIC CODE: [REDACTED]

SEE VEHICLE IDENTIFICATION NUMBER ON STEERING HEAD
NOISE LIMIT/CLOSING RPM: [REDACTED]DBA/[REDACTED]RPM

TE03434D S

(12)

MFD. BY KAWASAKI HEAVY INDUSTRIES, LTD.

DATE: [REDACTED] THIS VEHICLE CONFORMS TO ALL APPLICABLE FEDERAL MOTOR VEHICLE SAFETY STANDARDS IN EFFECT ON THE DATE OF MANUFACTURE SHOWN ABOVE. GVWR [REDACTED] LBS.

GVWR F [REDACTED] LBS WITH [REDACTED]

TIRE, [REDACTED] R/W, AT [REDACTED] PSI. COLD.

GVWR R [REDACTED] LBS WITH [REDACTED]

TIRE, [REDACTED] R/W, AT [REDACTED] PSI. COLD.

[REDACTED]

MOTOR CYCLE ([REDACTED]) MADE IN JAPAN

TE03303D S

(13) Only on California model

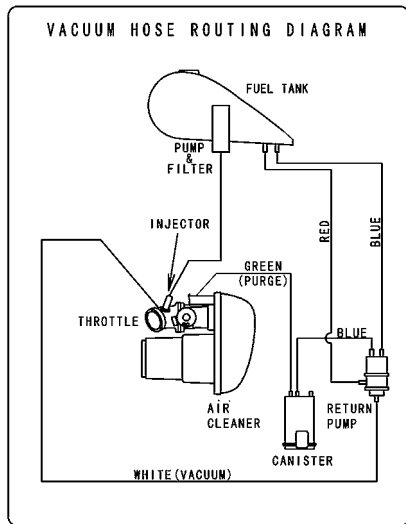

59464-1618

TE03425D07 C

240 LOCATION OF LABELS

(14)

VEHICLE EMISSION CONTROL INFORMATION	
ENGINE FAMILY CODE	PERFORMANCE FAMILY
WIRELESS	
EXHAUST EMISSION CONTROL SYSTEM	
DISPLACEMENT	
LINE UP SPECIFICATIONS	
IGNITION SWITCH	NO ADJUSTMENT
CLUTCH LEVER	NO ADJUSTMENT
VALVE CLEARANCE (HOT/COLD)	NO ADJUSTMENT
SPARK PLUG	SPARK PLUG GAP
ENGINE OIL	SERVICE RATING
	SEE THE OWNER'S MANUAL FOR ENGINE OIL INFORMATION
THIS VEHICLE CONFORMS TO U.S. EPA REGULATIONS APPLICABLE TO MODEL YEAR NEW MOTORCYCLES AND IS CERTIFIED TO AN EXHAUST EMISSION STANDARD OF	

TE03435D S

(14) Only on California model

VEHICLE EMISSION CONTROL INFORMATION	
ENGINE FAMILY CODE	PERFORMANCE FAMILY
WIRELESS	
EXHAUST EMISSION CONTROL SYSTEM	
DISPLACEMENT	
LINE UP SPECIFICATIONS	
IGNITION SWITCH	NO ADJUSTMENT
CLUTCH LEVER	NO ADJUSTMENT
VALVE CLEARANCE (HOT/COLD)	NO ADJUSTMENT
SPARK PLUG	SPARK PLUG GAP
ENGINE OIL	SERVICE RATING
	SEE THE OWNER'S MANUAL FOR ENGINE OIL INFORMATION
THIS VEHICLE CONFORMS TO CALIFORNIA AND CALIFORNIA REGULATIONS APPLICABLE TO MODEL YEAR NEW MOTORCYCLES AND IS CERTIFIED TO AN EXHAUST EMISSION STANDARD OF	

TE03433D S

(15)

TIRE AND LOAD DATA			
The stability and handling characteristics of this motorcycle could become unsafe by the use of improper tire inflation pressures, overworn tires, unsuitable replacement tires, or overloading. When tire tread wears down to the limit, replace the tire with only the standard tire. Maintain the inflation pressure specified.			
	Air Pressure (Cold)	Size & Make Type (Tubeless Tire)	Minimum Tread Depth
Front	Up to 180kg Load (397lbs) 200 kPa (2.00kg/cm ² /29psi)	BRIDGESTONE 130/90B16W/C 67H EXEDRA 6721 E	1 mm (0.04in)
Rear	Up to 87.5kg Load (191lbs) 250 kPa (2.50kg/cm ² /36psi) Up to 97.5kg Load (215.5lb) 280 kPa (2.80kg/cm ² /40psi)	BRIDGESTONE 170/90B16W/C 75H EXEDRA 6722 E	Up to 130 km/h (80MPH) 2 mm (0.08in) Over 130 km/h (80MPH) 3 mm (0.12in)

56053-0379

TE03421DN8 C

(16)

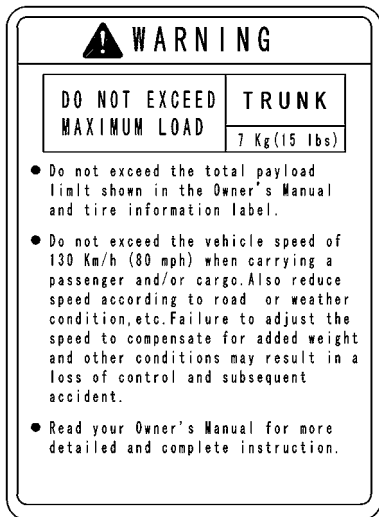

56071-0115

TE03424DN7 C

(17)

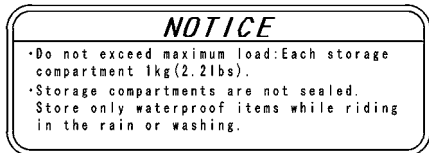

56071-0180

TE03809DZ2 C

(18)

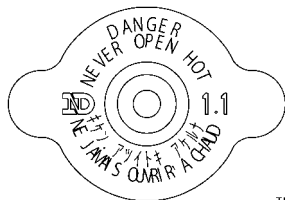

TE03353D S

VN1700AE

VN1700BE



* 9 9 9 8 7 - 1 7 8 2 *



KAWASAKI HEAVY INDUSTRIES, LTD.
Motorcycle & Engine Company
Part No. 99987-1782

Printed in Japan

GB