

YAMAHA

OWNER'S MANUAL

XV750H

4PV-28199-21

XV750H**OWNER'S MANUAL****©1995 by Yamaha Motor Co., Ltd.****1st Edition, September 1995****All rights reserved. Any reprinting or unauthorized use without the written permission of Yamaha Motor Co., Ltd. is expressly prohibited.****Printed in Japan****INTRODUCTION**

Congratulations on your purchase of the Yamaha XV750. This model is the result of Yamaha's vast experience in the production of fine sporting, touring, and pacesetting racing machines. It represents the high degree of craftsmanship and reliability that have made Yamaha a leader in these fields.

This manual will give you an understanding of the operation, inspection, and basic maintenance of this motorcycle. If you have any questions about the operation or maintenance of your motorcycle, please consult a Yamaha dealer.

Particularly important information is distinguished in this manual by the following notations:



The Safety Alert Symbol means ATTENTION! BECOME ALERT! YOUR SAFETY IS INVOLVED!

WARNING

Failure to follow **WARNING** instructions could result in severe injury or death to the motorcycle operator, a bystander or a person inspecting or repairing the motorcycle.

CAUTION:

A **CAUTION** indicates special precautions that must be taken to avoid damage to the motorcycle.

NOTE:

A **NOTE** provides key information to make procedures easier or clearer.

EUU00000

NOTE:

This manual should be considered a permanent part of this motorcycle and should remain with it even if the motorcycle is subsequently sold.

EUU13800

NOTE:

Yamaha continually seeks advancements in product design and quality. Therefore, while this manual contains the most current product information available at the time of printing, there may be minor discrepancies between your machine and this manual. If there is any question concerning this manual, please consult your Yamaha dealer.

 **WARNING**

**PLEASE READ THIS MANUAL CAREFULLY
AND COMPLETELY BEFORE OPERATING
THIS MOTORCYCLE.**

CONTENTS

SAFETY INFORMATION	1-1	Speedometer	5-6
LOCATION OF THE IMPORTANT LABEL	2-1	Tachometer	5-6
DESCRIPTION	3-1	Handlebar switches	5-7
MOTORCYCLE IDENTIFICATION	4-1	Clutch lever	5-8
Identification numbers record	4-1	Shift pedal	5-8
Key identification number	4-1	Front brake lever	5-9
Vehicle identification number	4-2	Rear brake pedal	5-9
Engine serial number	4-2	Fuel tank cap	5-9
CONTROL FUNCTIONS	5-1	Fuel cock	5-10
Main switch	5-1	Starter "CHOKE"	5-11
Indicator lights	5-2	Steering lock	5-12
Oil level indicator circuit check	5-3	Seat	5-13
Fuel indicator circuit check	5-5	Helmet holder	5-14
		Storage box	5-14
		Rear shock absorbers	5-15
		Sidestand	5-15
		Sidestand/clutch switch operation check	5-16

PRE-OPERATION CHECKS	6-1
Brakes	6-3
Brake fluid leakage (Front).....	6-3
Clutch	6-4
Throttle grip.....	6-4
Engine oil.....	6-4
Final gear oil.....	6-5
Tires	6-5
Tubeless tires and cast wheels	6-7
Fittings/Fasteners.....	6-9
Lights and signals.....	6-9
Switches	6-9
Battery.....	6-9
Fuel.....	6-9

OPERATION AND IMPORTANT RIDING POINTS	7-1
Starting and warming up a cold engine	7-1
Starting a warm engine	7-4
Shifting	7-4
Engine break-in.....	7-5
Parking.....	7-6

PERIODIC MAINTENANCE AND MINOR REPAIR	8-1
Tool kit.....	8-1
Periodic maintenance / lubrication.....	8-3
Torque specifications.....	8-6
Engine oil	8-7
Final gear oil	8-10
Air filter.....	8-12
Carburetor adjustment	8-14
Idle speed adjustment	8-14
Throttle cable adjustment	8-15
Valve clearance adjustment.....	8-16
Spark plug inspection	8-16

Front brake lever free play adjustment	8-18	Headlight bulb replacement.....	8-31
Rear brake pedal height and free play adjustment.....	8-19	Front wheel removal.....	8-33
Brake light switch adjustment.....	8-20	Front wheel installation	8-35
Checking the front brake pads and rear brake shoes.....	8-21	Rear wheel removal	8-36
Inspecting the brake fluid level	8-22	Rear wheel installation	8-38
Brake fluid replacement	8-23	Troubleshooting	8-39
Clutch lever free play adjustment....	8-23	Troubleshooting chart	8-40
Cable inspection and lubrication	8-24	CLEANING AND STORAGE	9-1
Throttle cable and grip lubrication ..	8-24	A. Cleaning.....	9-1
Brake and shift pedal lubrication	8-24	B. Storage.....	9-2
Brake and clutch lever lubrication ...	8-25	SPECIFICATIONS	10-1
Center and sidestand lubrication	8-25	HOW TO USE THE CONVERSION TABLE	11-1
Front fork inspection	8-25	NOISE REGULATION (FOR Australia).....	12-1
Rear shock absorber adjustment	8-26	WIRING DIAGRAM	
Steering inspection.....	8-27		
Wheel bearings	8-27		
Battery	8-28		
Fuse replacement	8-30		

⚠ SAFETY INFORMATION

TWO-WHEELED MOTORCYCLES ARE SINGLE TRACK VEHICLES. THEIR SAFE USE AND OPERATION ARE DEPENDENT UPON THE USE OF PROPER RIDING TECHNIQUES AS WELL AS THE EXPERTISE OF THE OPERATOR. EVERY OPERATOR SHOULD KNOW THE FOLLOWING REQUIREMENTS BEFORE RIDING.

HE OR SHE SHOULD:

- 1. OBTAIN THOROUGH INSTRUCTIONS FROM A COMPETENT SOURCE ON ALL ASPECTS OF MOTORCYCLE OPERATION.**
- 2. OBSERVE THE WARNINGS AND MAINTENANCE REQUIREMENTS IN THE OWNER'S MANUAL.**
- 3. OBTAIN QUALIFIED TRAINING IN SAFE AND PROPER RIDING TECHNIQUES.**
- 4. OBTAIN PROFESSIONAL TECHNICAL SERVICE AS INDICATED BY THE OWNER'S MANUAL AND/OR WHEN MADE NECESSARY BY MECHANICAL CONDITIONS.**

SAFE RIDING

- 1. Always make pre-operation checks. Careful checks may help prevent an accident.**
- 2. This motorcycle is designed to carry the operator and a passenger.**

3. The failure of motorists to detect and recognize motorcycles in traffic is the predominant cause of automobile/motorcycle accidents. Many accidents have been caused by an automobile driver who did not see the motorcycle. Making yourself conspicuous appears to be very effective in reducing the chance of this type of accident.

Therefore:

- a. Wear a brightly colored jacket.**
 - b. Use extra caution when you approach and pass through intersections, since intersections are the most likely places for motorcycle accidents.**
 - c. Ride where other motorists can see you. Avoid riding in another motorist's "blind spot".**
- 4. Many accidents involve inexperienced operators. In fact, many operators who have been involved in accidents do not even have a current motorcycle license.**
- a. Make sure you are qualified. Also, only lend your motorcycle to experienced operators.**
 - b. Know your skills and limits. Staying within your limits may help you to avoid an accident.**
 - c. We recommend that you practice riding your motorcycle where there is no traffic until you have become thoroughly familiar with your motorcycle and all of its controls.**

- 5. Many motorcycle accidents have been caused by motorcycle operator errors. A typical error made by the operator is veering wide on a turn due to EXCESSIVE SPEED or undercornering (insufficient lean angle for the speed).**
 - a. Always obey the speed limits and never travel faster than warranted by road and traffic conditions.**
 - b. Always signal before turning or changing lanes. Make sure other motorists see you.**
- 6. The operator's and passenger's posture are important for proper control.**
 - a. The operator should keep both hands on the handlebars and both feet on the operator footrests during operation to maintain control of the motorcycle.**
 - b. The passenger should always hold on to the operator, or the seat strap or grab bar if the motorcycle is so equipped, with both hands and keep both feet on the passenger footrests.**
 - c. Never carry a passenger unless he or she can firmly place both feet on the passenger footrests.**
- 7. Never ride under the influence of alcohol or drugs.**
- 8. This motorcycle is designed for on-road use only. It is not suitable for off-road use.**

PROTECTIVE APPAREL

The majority of fatalities from motorcycle accidents are the result of head injuries. The use of a safety helmet is the single most critical factor in the prevention or reduction of head injuries.

1. Always wear an approved helmet.
2. Wear a face shield or goggles. Wind on your unprotected eyes could contribute to an impairment of vision which could delay seeing a hazard.
3. The use of heavy boots, jacket, trousers, gloves, etc. is effective in preventing or reducing abrasions or lacerations.
4. Never wear loose fitting clothing. It could catch on the control levers, footrests, or wheels and cause injury or accident.
5. Never touch the engine or exhaust system during or after operation. They become very hot and can cause burns. Always wear protective clothing that covers your legs, ankles, and feet.
6. A passenger should also observe the above precautions.

MODIFICATION

Modifications made to the motorcycle not approved by Yamaha, or the removal of original equipment, may render your motorcycle unsafe for use and may cause severe personal injury. Modifications may also make your motorcycle illegal to use.

LOADING AND ACCESSORIES

Adding accessories or cargo to your motorcycle can adversely affect stability and handling if the weight distribution of the machine is changed. To avoid the possibility of an accident, extreme caution should be used if adding cargo or accessories to your motorcycle. Use extra care if riding a motorcycle which has added cargo or accessories. Here are some general guidelines to follow if loading cargo or adding accessories to your motorcycle:

LOADING

The total weight of the operator, passenger, accessories and cargo must not exceed the maximum load limit of 235 kg.

When loading within these weight limits, keep the following in mind:

1. Cargo and accessory weight should be kept as low and close to the motorcycle as possible. Be sure to distribute the weight as evenly as possible on both sides of the machine to minimize imbalance or instability.
2. Shifting weights can create a sudden imbalance. Make sure that accessories and cargo are securely attached to the motorcycle before riding. Recheck accessory mounts and cargo restraints frequently.

- 3. Never attach any large or heavy items to the handlebars, front forks, or front fender. These items, including such cargo as sleeping bags, duffle bags, or tents, can create unstable handling or slow steering response.**

ACCESSORIES

Genuine Yamaha accessories have been specifically designed for use on this motorcycle. Since Yamaha cannot test all other accessories which may be available, you must personally be responsible for the proper selection, installation and use of non-Yamaha accessories. You should use extreme caution when selecting and installing any accessories.

Keep in mind these guidelines for mounting accessories in addition to those provided under "LOADING".

- 1. Never install accessories or carry cargo that would impair the performance of your motorcycle. Carefully inspect the accessory before using it to make sure it does not in any way reduce ground clearance or cornering clearance, limit suspension travel, steering travel or control operation, or obscure lights or reflectors.**
 - a. Accessories fitted to the handlebar or the front fork area can create instability due to improper weight distribution or aerodynamic changes. If accessories are added to the handlebar or front fork area, they must be as lightweight as possible and should be kept to a minimum.**

- b. **Bulky or large accessories may seriously affect the stability of the motorcycle due to aerodynamic effects. Wind may attempt to lift the motorcycle, or the motorcycle may become unstable in cross winds. These accessories may also cause instability when being passed by or passing large vehicle.**
 - c. **Certain accessories can displace the operator from his or her normal riding position. This improper position limits the freedom of movement of the operator and may limit control ability. Therefore such accessories are not recommended.**
2. **Caution must be used if adding electrical accessories. If these accessories exceed the capacity of the motorcycle's electrical system, an electric failure could result, which could cause a dangerous loss of lights or engine power.**

GASOLINE AND EXHAUST GAS

1. **GASOLINE IS HIGHLY FLAMMABLE:**
- a. **Always turn off the engine when refueling.**
 - b. **Take care not to spill any gasoline on the engine or exhaust pipe(s)/muffler(s) when refueling.**
 - c. **Never refuel while smoking or in the vicinity of an open flame.**
2. **Never start the engine or let it run for any length of time in a closed area. The exhaust fumes are poisonous and may cause loss of consciousness and death within a short time. Always operate your motorcycle in an area that has adequate ventilation.**

- 3. Always turn off the engine before leaving the motorcycle unattended and remove the ignition key. When parking the motorcycle, note the following:**
 - a. The engine and exhaust pipe(s)/muffler(s) may be hot. Park the motorcycle in a place where pedestrians or children are not likely to touch these hot areas.**
 - b. Do not park the motorcycle on a slope or soft ground; the motorcycle may fall over.**
 - c. Do not park the motorcycle near a flammable source, e.g. a kerosene heater, or near an open flame. The motorcycle could catch fire.**
- 4. When transporting the motorcycle in another vehicle, be sure it is kept upright and that the fuel cock(s) is turned to "ON" or "RES" (for vacuum type)/"OFF" (for manual type). If it should lean over, gasoline may leak out of the carburetor or fuel tank.**
- 5. If you should swallow any gasoline, inhale a lot of gasoline vapor, or allow gasoline to get in your eye(s), see your doctor immediately. If any gasoline spills on your skin or clothing, immediately wash it off with soap and water and change your clothes.**

LOCATION OF THE IMPORTANT LABEL

Please read the following label carefully before operating this motorcycle.

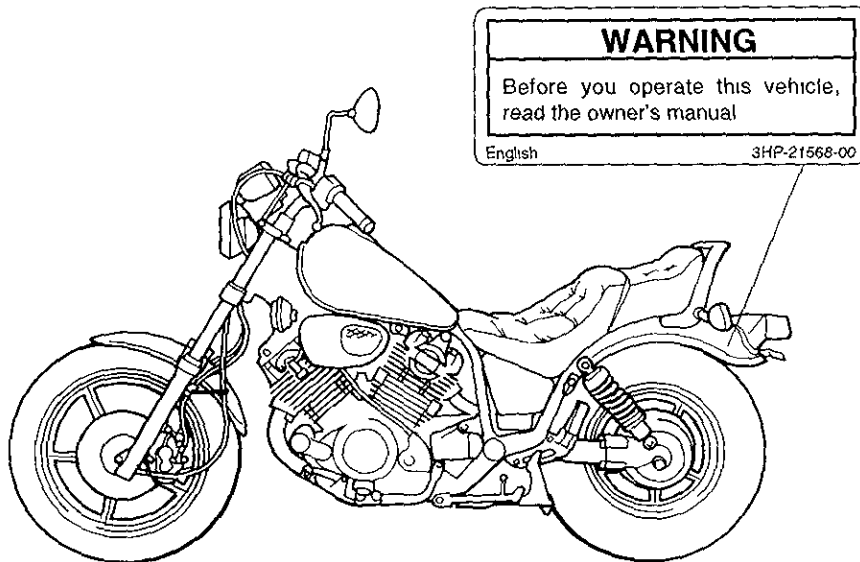

DESCRIPTION

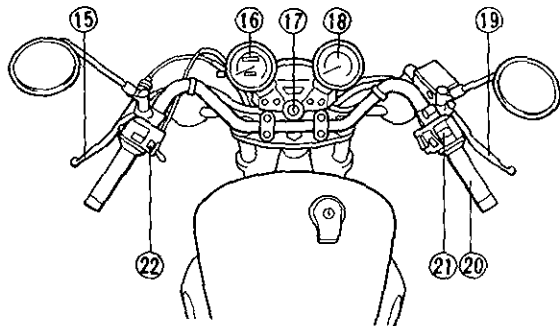
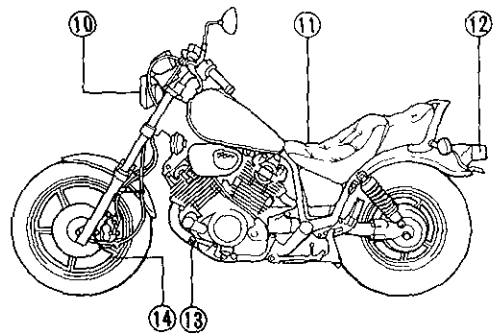
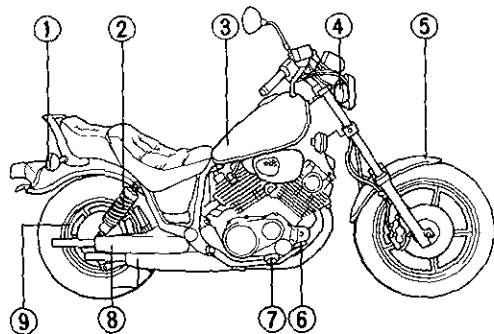

- | | |
|-----------------------|-----------------------------|
| 1 Rear flasher light | 12. Tail/Brake light |
| 2 Rear shock absorber | 13 Shift pedal |
| 3 Fuel tank | 14 Front wheel |
| 4 Front flasher light | 15 Clutch lever |
| 5 Front fender | 16. Speedometer |
| 6. Brake pedal | 17 Main switch |
| 7. Footrest | 18 Tachometer |
| 8. Silencer | 19 Brake lever |
| 9 Rear wheel | 20 Throttle grp |
| 10. Headlight | 21 Right handlebar switches |
| 11. Seat | 22 Left handlebar switches |

MOTORCYCLE IDENTIFICATION

EAA60402

Identification numbers record

Record the key identification number, vehicle identification number and engine serial number in the spaces provided for assistance when ordering spare parts from a Yamaha dealer or for reference in case the vehicle is stolen.

1. KEY IDENTIFICATION NUMBER:

2. VEHICLE IDENTIFICATION NUMBER:

3. ENGINE SERIAL NUMBER:

EAA61400

Key identification number

The key identification number is stamped on the key. Record this number in the space provided and use it for reference when obtaining a new key.

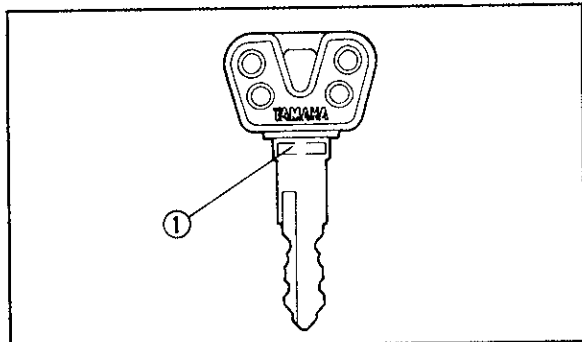

1. Key identification number

Vehicle identification number

The vehicle identification number is stamped into the steering head pipe.

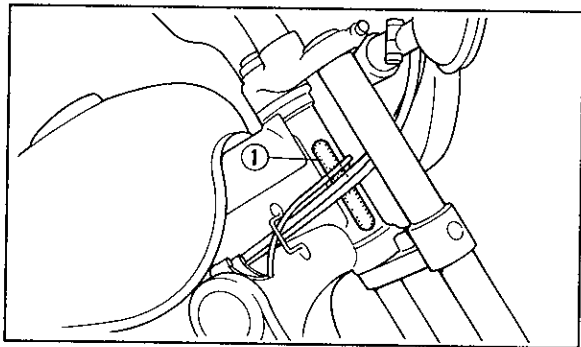

1 Vehicle identification number

EUU00400

NOTE:

The vehicle identification number is used to identify your motorcycle and may be used to register your motorcycle with the licensing authority in your state.

Engine serial number

The engine serial number is stamped into the crankcase.

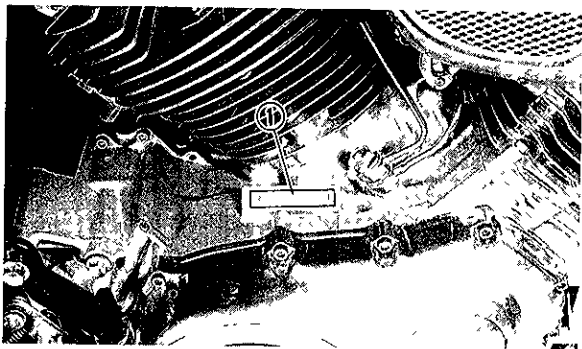

1 Engine serial number

EUU00300

NOTE:

The first three digits of these numbers are for model identification; the remaining digits are the unit production number. Keep a record of these numbers for reference when ordering parts from a Yamaha dealer.

CONTROL FUNCTIONS

Main switch

The main switch controls the ignition and lighting systems. Its operation is described below.

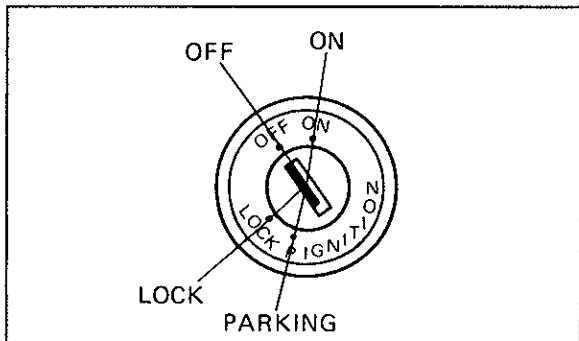

ON:

Electrical circuits are switched on, and the headlight, meter light, and taillight come on. The engine can be started. The key cannot be removed in this position.

OFF:

All electrical circuits are switched off. The key can be removed in this position.

LOCK:

The steering is locked in this position, and all electrical circuits are switched off. The key can be removed in this position. Refer to "Steering lock" (page 5-12) for operation instructions.

P (Parking)

The steering is locked in this position, and the taillight comes on but all other circuits are off. The key can be removed in this position.

NOTE:

Always turn the main switch to "OFF" or "LOCK" and remove the key when the motorcycle is unattended.

Indicator lights

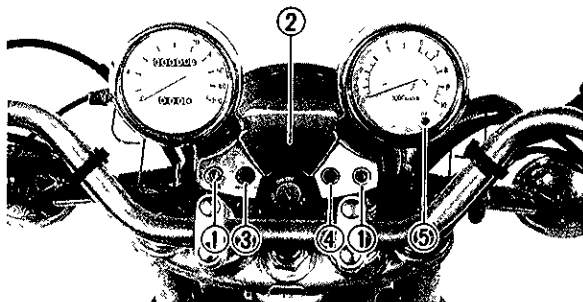

1. Turn indicator lights "TURN"
2. Neutral indicator light "NEUTRAL"
3. High beam indicator light "HIGH BEAM"
4. Oil level indicator light "OIL"
5. Fuel indicator light "FUEL"

Turn indicator lights "TURN"

The corresponding indicator flashes when the turn switch is moved to the left or right.

Neutral indicator light "NEUTRAL"

This indicator comes on when the transmission is in neutral.

High beam indicator light "HIGH BEAM"

This indicator comes on when the headlight high beam is used.

Oil level indicator light "OIL"

This indicator comes on when the oil level is low. This light circuit can be checked by the following procedure.

CAUTION:

Do not run the motorcycle until you know it has sufficient engine oil.

Oil level indicator circuit check

Turn the main switch to "ON" and the engine stop switch to "RUN".

Oil level indicator light does not come on.

Put the transmission in neutral or apply the clutch lever, then push the start switch.

Oil level indicator light comes on.

Engine oil level and electrical circuit are OK. Go ahead with riding.

Oil level indicator light does not come on.

Ask a Yamaha dealer to inspect electrical circuit.

Oil level indicator light comes on.

Check engine oil level.

Oil level is OK.

Oil level is low.

Supply engine oil.

Fuel indicator light "FUEL"

When the fuel level drops below approximately 2.5 L, this light will come on. When this light comes on, switch the fuel cock to "RES". Then, fill the tank at the first opportunity.

Fuel indicator circuit check

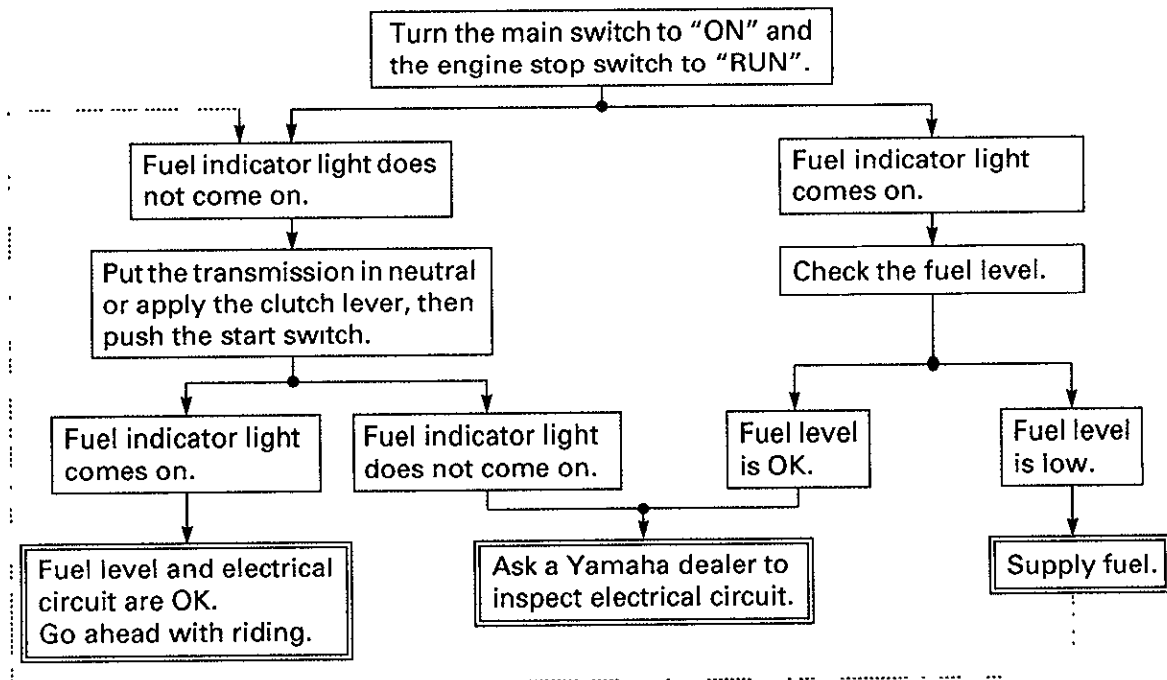

Speedometer

The speedometer shows riding speed. This speedometer is equipped with an odometer and trip odometer. The trip odometer can be reset to "0" with the reset knob. Use the trip odometer to estimate how far you can ride on a tank of fuel. This information will enable you to plan fuel stops in the future.

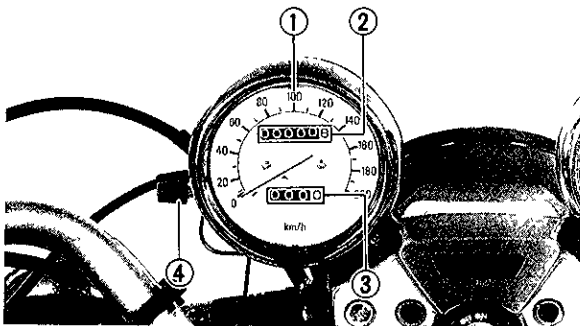

- | | |
|-----------------|--------------|
| 1 Speedometer | 2 Odometer |
| 3 Trip odometer | 4 Reset knob |

Tachometer

This model is equipped with an electric tachometer so the rider can monitor the engine speed and keep it within the ideal power range.

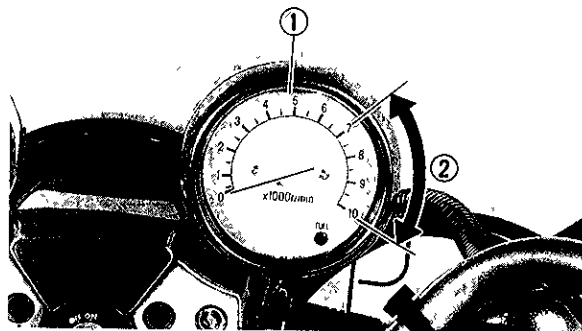

- | | |
|--------------|------------|
| 1 Tachometer | 2 Red zone |
|--------------|------------|

EUU30400

CAUTION

Do not operate in the red zone
Red zone: 7,000 r/min and above.

Handlebar switches

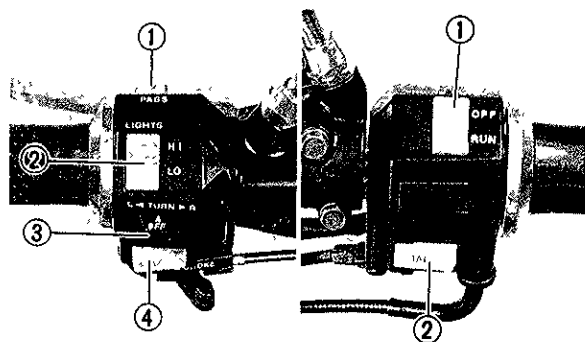

- | | |
|-----------------------------|---------------------------------------|
| 1. Pass switch "PASS" | 1 Engine stop switch
"ENGINE STOP" |
| 2 Dimmer switch
"LIGHTS" | 2 Start switch "START" |
| 3 Turn signal switch "TURN" | |
| 4 Horn switch "HORN" | |

EAB63201

Pass switch "PASS"

Press the switch to operate the passing light.

EAB60101

Dimmer switch "LIGHTS"

Turn the switch to "HI" for the high beam and to "LO" for the low beam.

EAB60301

Turn signal switch "TURN"

This model is equipped with self-cancelling turn signals. To signal a right-hand turn, push the switch to the right. To signal a left-hand turn, push the switch to the left. Once the switch is released it will return to the center position. To cancel the signal, push the switch in after it has returned to the center position. If the switch is not cancelled by hand, it will self-cancel after the motorcycle has travelled for about 10 seconds or approximately 150 m whichever is greater. The self-cancelling mechanism only operates when the motorcycle is moving. Therefore the signal will not self-cancel while you are stopped at an intersection.

EAB60201

Horn switch "HORN"

Press the switch to sound the horn.

EAB60902

Engine stop switch “ENGINE STOP”

The engine stop switch is a safety device for use in an emergency such as when the motorcycle overturns or if trouble occurs in the throttle system. Turn the switch to “RUN” to start the engine. In case of emergency, turn the switch to “OFF” to stop the engine.

EAB60703

Start switch “START”

The starter motor cranks the engine when pushing the start switch.

EUU30700

CAUTION

See starting instructions prior to starting the engine.

EAB70002

Clutch lever

The clutch lever is located on the left handlebar, and the ignition circuit cut-off system is incorporated in the clutch lever holder. Pull the clutch lever to the handlebar to disengage the clutch, and release the lever to engage the clutch. The lever should be pulled rapidly and released slowly for smooth clutch operation. (Refer to the engine starting procedures for a description of the starting circuit cut-off system.)

EAB80001

Shift pedal

This motorcycle is equipped with a constant-mesh 5-speed transmission. The shift pedal is located on the left side of the engine and is used in combination with the clutch when shifting.

EAC00101

Fuel tank cap

TO OPEN:

Insert the key and turn it 1/4 turn clockwise. The lock will be released and the cap can be opened.

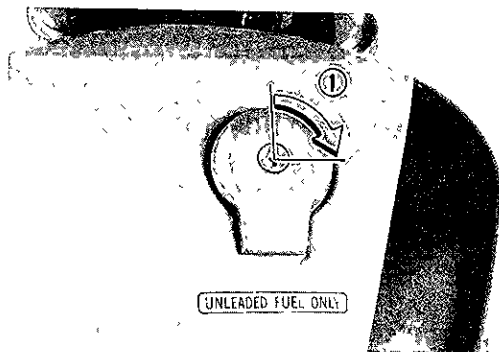

1 Open

TO CLOSE:

Push the tank cap into position with the key inserted. To remove the key, turn it counterclockwise to the original position.

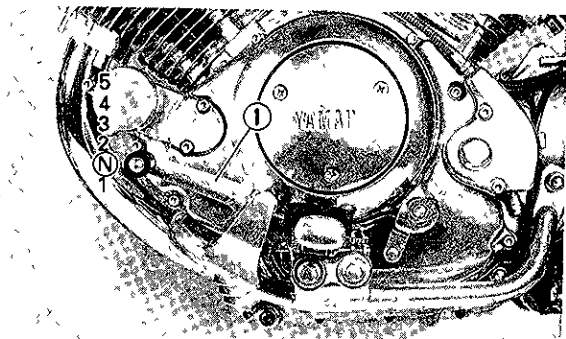

1 Shift pedal

N Neutral

EAB90001

Front brake lever

The front brake lever is located on the right handlebar. Pull it toward the handlebar to apply the front brake.

EAB90101

Rear brake pedal

The rear brake pedal is on the right side of the motorcycle. Press down on the brake pedal to apply the rear brake.

NOTE:

This tank cap cannot be closed unless the key is in the lock. The key cannot be removed if the cap is not locked properly.

⚠ WARNING

Be sure the cap is properly installed and locked in place before riding the motorcycle.

Fuel cock

The negative pressure fuel cock supplies fuel from the tank to the carburetors while filtering it also.

The fuel cock has the following three positions:

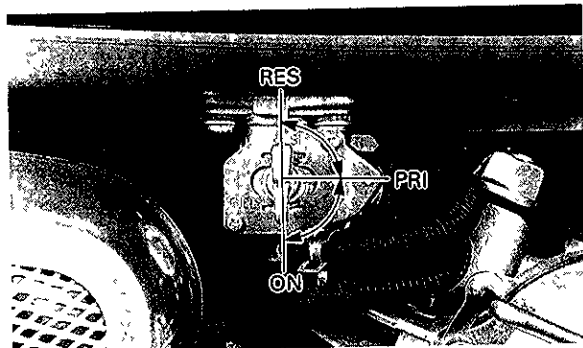

ON: With the lever in this position, fuel flows if the engine is running, but stops if the engine is not running.

RES: This indicates reserve. If you run out of fuel while riding, move the lever to "PRI", start the engine, then move the lever to "RES". **FILL THE TANK AT THE FIRST OPPORTUNITY. BE SURE TO MOVE THE LEVER TO "ON" AFTER REFUELING.**

NOTE:

The fuel cock operates on vacuum from the engine when set at "ON" or "RES". If the line connecting the cock to the carburetor intake manifold is not connected or has a leak, the cock will not function properly.

PRI: This indicates prime. With the lever in this position, fuel flows whether the engine is running or not. If the fuel tank is completely empty, refill the tank, prime the carburetor in this position, and then switch to "ON" after starting the engine.

Starter "CHOKE"

Starting a cold engine requires a richer air-fuel mixture. A separate starter circuit supplies this mixture.

Move in direction (a) to turn on the starter.
Move in direction (b) to turn off the starter.

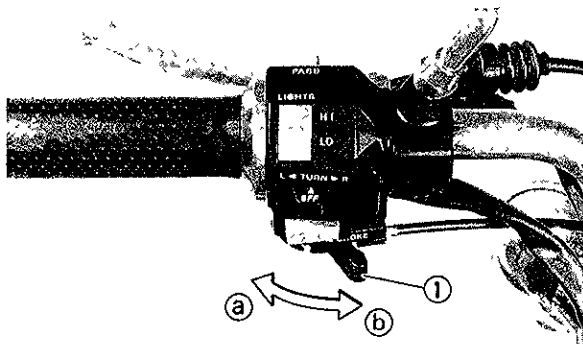

1 Starter "CHOKE"

Steering lock

The steering is locked when the main switch is turned to "LOCK". To lock the steering, turn the handlebars all the way to the left or right. With the key at "OFF", push it into the main switch and release it, turn it counterclockwise to "LOCK", and remove it. To release the lock, turn the key to "OFF".

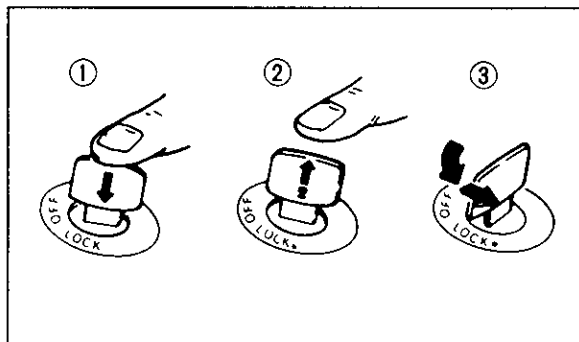
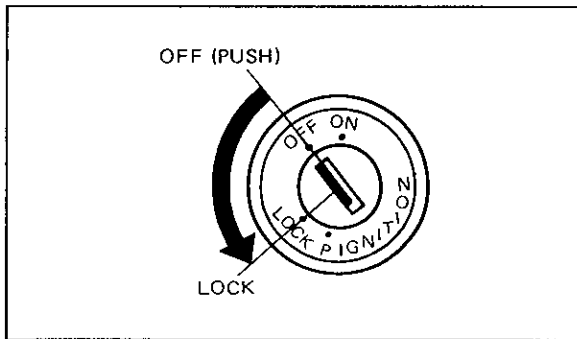

1 Push

2 Release

3 Turn

EUU61400

WARNING

Never turn the key to "LOCK" when the motorcycle is moving.

Seat

1. Remove the storage box cover on the left side and the battery cover on the right side.
2. Remove the seat by removing the bolts.

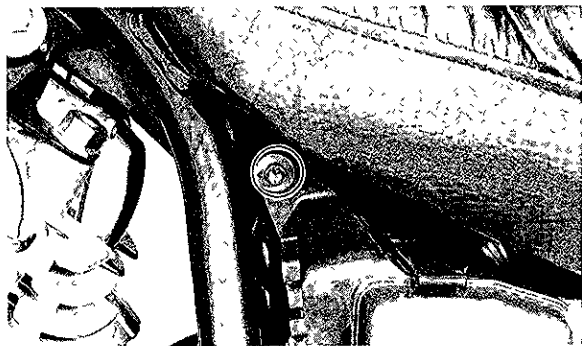

3. When reinstalling the seat, insert the lobe on the rear of the seat into the receptacle on the frame, then tighten the bolts.

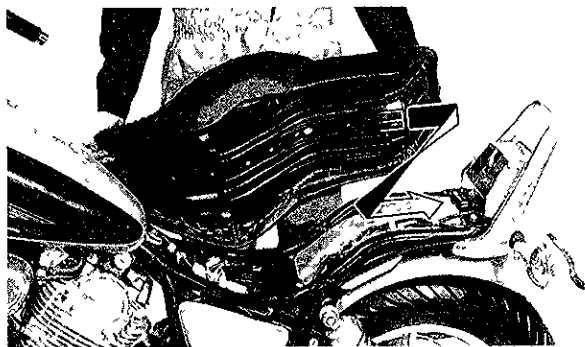

4. Reinstall the storage box cover and the battery cover.

EUU01700

NOTE:

Make sure that the seat is securely fitted.

Helmet holder

To open the helmet holder, insert the key in the lock and turn it as shown. To lock the helmet holder, replace the holder in its original position.

EUU72900

⚠ WARNING

Never ride with a helmet in the helmet holder. The helmet may hit objects, causing loss of control and possibly an accident.

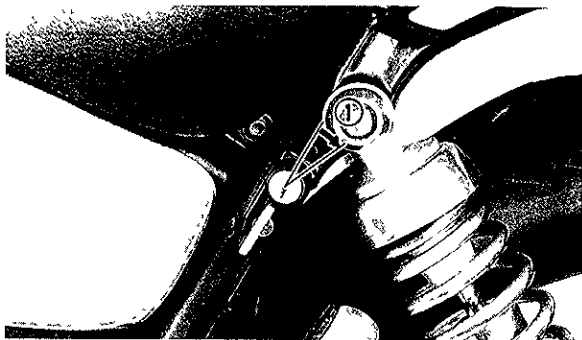

1 Open

Storage box

The storage box is located behind the storage box cover on the left side.

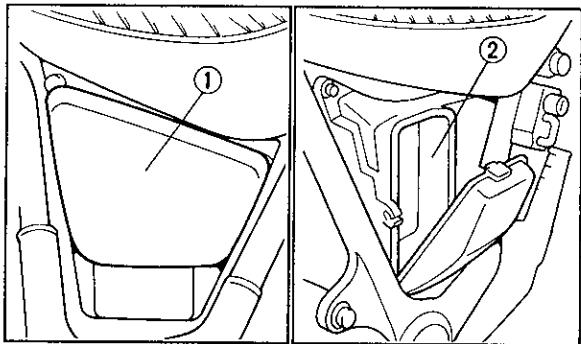

1 Storage box cover

2 Storage box

Rear shock absorbers

The spring preload of the rear shock absorbers can be adjusted to suit the rider's preference, motorcycle's load (e.g. optional accessories, etc.) and road conditions. (See page 8-26 for details.)

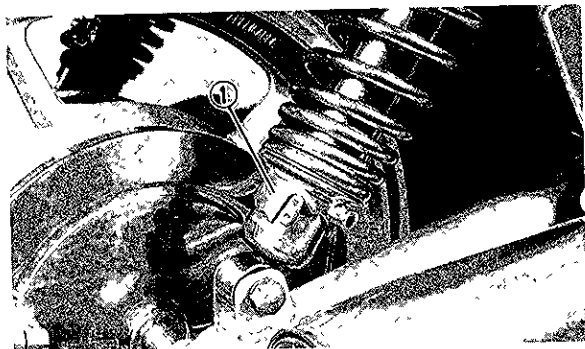

1 Spring preload adjuster

Sidestand

This model is equipped with an ignition circuit cut-off system. The motorcycle must not be ridden when the sidestand is down. The sidestand is located on the left side of the frame. (Refer to page 7-1 for an explanation of this system.)

EUV68901

⚠ WARNING

This motorcycle must not be operated with the sidestand in the down position. If the stand is not properly retracted, it could contact the ground and distract the operator, resulting in a possible loss of control. Yamaha has designed into this motorcycle a lockout system to assist the operator in fulfilling the responsibility of retracting the sidestand. Please check carefully the operating instructions listed below and if there is any indication of a malfunction, return the motorcycle to a Yamaha dealer immediately for repair.

Sidestand/clutch switch operation check

Check the operation of the sidestand switch and clutch switch against the information below.

EUU69001

⚠ WARNING

- **Be sure to use the centerstand during this inspection.**
- **If improper operation is noted, consult a Yamaha dealer.**

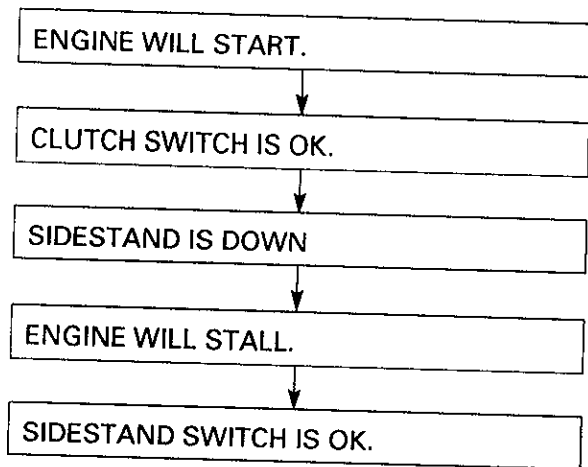
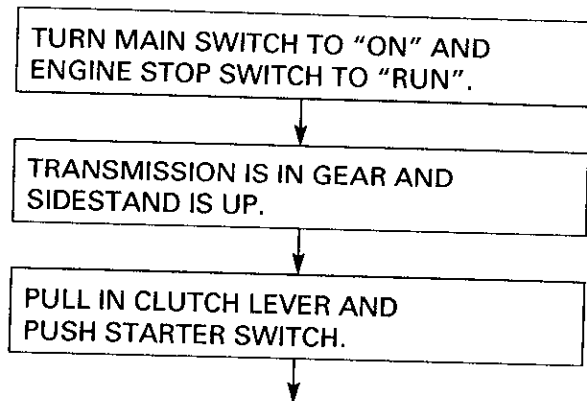

PRE-OPERATION CHECKS

Before using this motorcycle, check the following points:

ITEM	ROUTINE	PAGE
Front brake	<ul style="list-style-type: none"> • Check operation, free play, fluid level and fluid leakage. • Fill with DOT 4 (or DOT 3) brake fluid if necessary. 	6-3~6-4, 8-18~8-23
Rear brake	<ul style="list-style-type: none"> • Check operation, condition and free play. • Adjust if necessary 	
Clutch	<ul style="list-style-type: none"> • Check operation, condition and free play. • Adjust if necessary. 	6-4, 8-23
Throttle grip/housing	<ul style="list-style-type: none"> • Check for smooth operation. • Lubricate if necessary. 	6-4, 8-15, 8-24
Engine oil	<ul style="list-style-type: none"> • Check oil level/fill engine with oil as required. 	6-4, 8-7~8-10
Final gear oil	<ul style="list-style-type: none"> • Check for leakage. 	6-5, 8-10~8-12
Wheels/tires	<ul style="list-style-type: none"> • Check tire pressure, wear and damage 	6-5~6-9, 8-33~8-39
Control/meter cables	<ul style="list-style-type: none"> • Check for smooth operation • Lubricate if necessary. 	8-24
Brake and shift pedal shafts	<ul style="list-style-type: none"> • Check for smooth operation. • Lubricate if necessary. 	8-24
Brake and clutch lever pivots	<ul style="list-style-type: none"> • Check for smooth operation. • Lubricate if necessary 	8-25
Center and sidestand pivots	<ul style="list-style-type: none"> • Check for smooth operation. • Lubricate if necessary. 	8-25

ITEM	ROUTINE	PAGE
Fittings/Fasteners	<ul style="list-style-type: none"> • Check all chassis fittings and fasteners. • Tighten/adjust if necessary. 	6-9, 8-6
Fuel tank	<ul style="list-style-type: none"> • Check fuel level. • Fill with fuel as required. 	6-9~6-10
Lights and signals	<ul style="list-style-type: none"> • Check for proper operation. 	6-9, 8-31~8-33
Battery	<ul style="list-style-type: none"> • Check fluid level • Fill with distilled water if necessary. 	6-9, 8-28~8-29

NOTE:

Pre-operation checks should be made each time the motorcycle is used. Such an inspection can be thoroughly accomplished in a very short time, and the added safety it assures is more than worth the time involved.

⚠ WARNING

If any item in the Pre-Operation Check is not working properly, have it inspected and repaired before operating the motorcycle.

Brakes

1. Brake lever and brake pedal

Check for correct free play in the front brake lever and rear brake pedal and adjust if necessary. Make sure the brakes are working properly by checking at low speed shortly after starting out (see page 8-18 for details).

EUU62300

WARNING

A soft, spongy feeling in the brake lever indicates a failure in the brake system. Do not operate the motorcycle until the failure in the brake system is corrected. Ask a Yamaha dealer for immediate repairs. A soft, spongy feeling could indicate a hazardous condition in the brake system.

2. Brake fluid

Check the brake fluid level. Fill the master cylinder with brake fluid if necessary.

Recommended brake fluid: DOT 4

EUU13100

NOTE:

If DOT 4 is not available, DOT 3 can be used.

3. Check the disc pads.

Refer to page 8-21.

4. Check the brake shoes.

Refer to page 8-21.

EUU02201

NOTE:

When this brake service is necessary, consult a Yamaha dealer.

EAE11302

Brake fluid leakage (Front)

Apply the brake for a few minutes. Check to see if any brake fluid leaks out from the pipe joints or the master cylinder.

EUU37801

CAUTION

Brake fluid may deteriorate painted surfaces or plastic parts. Never spill any fluid. If spilled, clean it up immediately.

⚠ WARNING

If brake fluid leakage is found, ask a Yamaha dealer for immediate repairs. Such leakage could indicate a hazardous condition.

Clutch

Check the free play in the clutch lever, and make sure the clutch operates properly. If the free play is incorrect, adjust it. (see page 8-23 for details)

Throttle grip

Turn the throttle grip to see if it operates properly, and check the free play. Make sure the grip returns by spring force when released. Ask a Yamaha dealer to make any necessary adjustments (see page 8-15 for details).

Engine oil

Make sure the engine oil is at the specified level. Fill with oil as necessary (see page 8-7 for details).

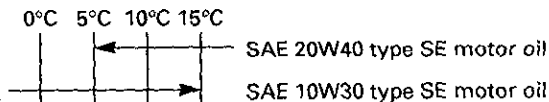
Recommended oil:**Recommended engine oil classification:**

API Service "SE", "SF" type or equivalent
(e.g. "SF-SE", "SF-SE-CC",
"SF-SE-SD" etc.)

Oil quantity:

Total amount:

3.6 L

Periodic oil change:

3.0 L

With oil filter replacement:

3.1 L

Final gear oil

Make sure the final gear oil is at the specified level. Fill with oil as necessary (see page 8-10 for details).

Recommended oil:

SAE 80 API GL-4 Hypoid gear oil
If desired, an SAE 80W90 hypoid gear oil may be used for all conditions.

NOTE:

"GL-4" is a quality and additive rating. "GL-5" or "GL-6" rated hypoid gear oils may also be used.

Tires

To ensure maximum performance, long service, and safe operation, note the following:

1. Tire air pressure

Always check and adjust the tire pressure before operating the motorcycle.

WARNING

Tire inflation pressure should be checked and adjusted when the temperature of the tire equals the ambient air temperature. Tire inflation pressure must be adjusted according to total weight of cargo, rider, passenger, and accessories (fairing, saddlebags, etc. if approved for this model), and vehicle speed.

Basic weight: With oil and full fuel tank	235 kg	
Maximum load*	235 kg	
Cold tire pressure*	Front	Rear
Up to 90 kg load*	200 kPa (2.00 kg/cm ² , 2.00 bar)	225 kPa (2.25 kg/cm ² , 2.25 bar)
90 kg load ~ Maximum load*	200 kPa (2.00 kg/cm ² , 2.00 bar)	250 kPa (2.50 kg/cm ² , 2.50 bar)

* Load is the total weight of cargo, rider, passenger, and accessories.

⚠ WARNING

Proper loading of your motorcycle is important for several characteristics of your motorcycle; such as handling, braking, performance and safety. Do not carry loosely packed items that can shift. Securely pack your heaviest items close to the center of the motorcycle, and distribute the weight evenly from side to side. Properly adjust the suspension for your load, and check the condition and pressure of your tires. **NEVER OVERLOAD YOUR MOTORCYCLE.** Make sure the total weight of the cargo, rider, passenger, and accessories (fairing, saddlebags, etc. if approved for this model) does not exceed the maximum load of the motorcycle. Operation of an overloaded motorcycle could cause tire damage, an accident, or even injury.

2. Tire inspection

Always check the tires before operating the motorcycle. If a tire tread shows crosswise lines (minimum tread depth), if the tire has a nail or glass fragments in it, or if the side wall is cracked, contact a Yamaha dealer immediately and have the tire replaced.

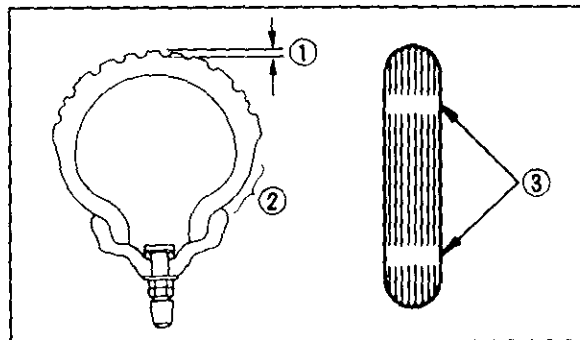

1 Tread depth 2 Side wall 3 Wear indicator

FRONT

Manufacturer	Size	Type
Bridgestone	100/90-19 57H	G535
Dunlop	100/90-19 57H	F17

REAR.

Manufacturer	Size	Type
Bridgestone	140/90-15 M/C 70H	G536
Dunlop	140/90-15 M/C 70H	K425

Minimum tire tread depth (front and rear)	1.0 mm
--	--------

EUU67900

⚠ WARNING

It is dangerous to ride with a worn-out tire. When a tire tread begins to show lines, have a Yamaha dealer replace the tire immediately. Brakes, tires, and related wheel parts replacement should be left to a Yamaha Service Technician.

EAE93800

Tubeless tires and cast wheels

This motorcycle is equipped with cast wheels designed for either tube-type or tubeless tires. Tubeless tires are installed as standard equipment.

EUU68600

⚠ WARNING

Do not attempt to use tubeless tires on a wheel designed for use only with tube-type tires. Tire failure and personal injury may result from sudden deflation.

Tubeless-type Wheel

→ Tubeless or Tube-type Tires

Tube Wheel

→ Tube-type Tires only

EUU68700

⚠ WARNING

When using tube-type tires, be sure to install the proper tube also.

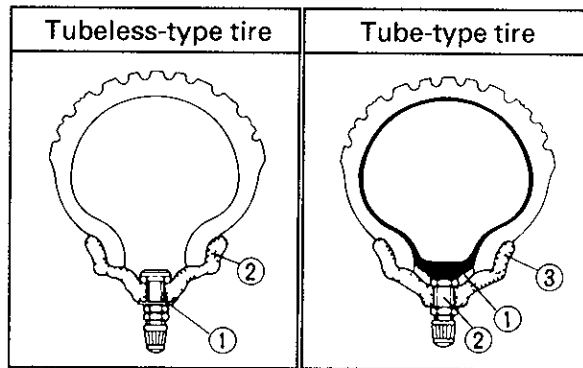
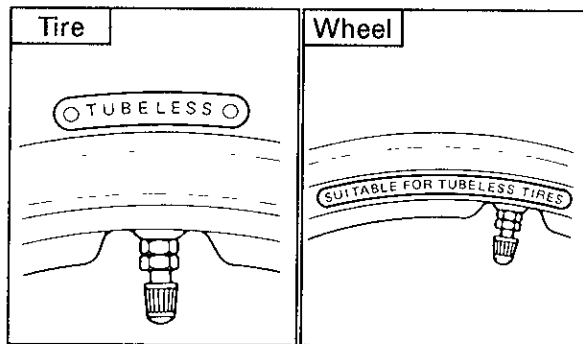

- 1 Air valve
 2 Cast wheel
 (Tubeless wheel)

- 1 Tube
 2 Air valve
 3 Cast wheel

To ensure maximum performance, long service, and safe operation, note the following:

1. Always inspect the wheels before a ride. Check for cracks, bends, or warpage of the wheels. If any abnormal condition exists in a wheel, consult a Yamaha dealer. Do not attempt even small repairs to the wheel. If a wheel is deformed or cracked, it must be replaced.
2. Tires and wheels should be balanced whenever either one is changed or replaced. Failure to have a wheel balanced can result in poor performance, adverse handling characteristics, and shortened tire life.
3. After installing a tire, ride conservatively to allow the tire to seat itself on the rim properly. Failure to allow proper seating may cause tire failure, resulting in damage to the motorcycle and injury to the rider.

4. After repairing or replacing a tire, check to be sure the valve stem lock nut is securely fastened. If not, torque is as specified.

Tightening torque:

Lower: 0.5 Nm (0.05 m·kg)

Upper: 1.5 Nm (0.15 m·kg)

EAE85000

Fittings/Fasteners

Always check the tightness of chassis fittings and fasteners before a ride. Use the chart on page 8-6 to find the correct torque.

EAE70000

Lights and signals

Check the headlight, flasher lights, tail-light, brake light, meter lights, and all the indicator lights to make sure they are in working condition.

EAE70701

Switches

Check the operation of the headlight switch, turn switch, brake light switch, horn switch, start switch, main switch, etc.

EAE70501

Battery

Check the fluid level and fill if necessary. Use only distilled water if refilling is necessary (see page 8-28 for details).

EAE80000

Fuel

Make sure there is sufficient fuel in the tank.

EUU61000

WARNING

Do not overfill the fuel tank. Avoid spilling fuel on the hot engine. Do not fill the fuel tank above the bottom of the filler tube as shown in the illustration or it may overflow when the fuel heats up later and expands.

CAUTION:

Always wipe off spilled fuel immediately with a dry and clean soft cloth. Fuel may deteriorate painted surfaces or plastic parts.

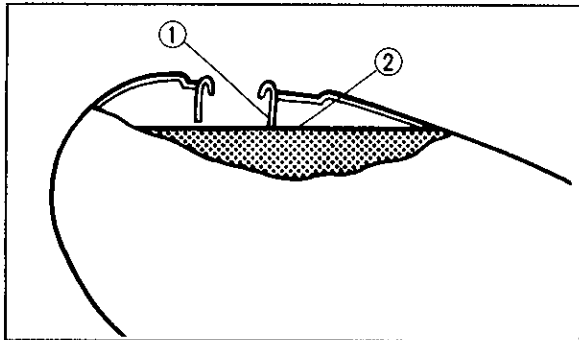

1 Filler tube

2 Fuel level

Recommended fuel:

Regular gasoline

For Australia:

Unleaded fuel only

Fuel tank capacity:

Total: 14.5 L

Reserve: 2.5 L

OPERATION AND IMPORTANT RIDING POINTS

EUU67200

WARNING

Before riding this motorcycle, become thoroughly familiar with all operating controls and their functions. Consult a Yamaha dealer regarding any control or function that you do not thoroughly understand.

EUU62800

WARNING

1. Never start your engine or let it run for any length of time in a closed area. The exhaust fumes are poisonous and can cause loss of consciousness and death within a short time. Always operate your motorcycle in an area with adequate ventilation.

2. Before starting out, always be sure the sidestand is up. Failure to retract the sidestand completely can result in a serious accident when you try to turn a corner.

EAF12803

Starting and warming up a cold engine

EUU02800

NOTE:

This motorcycle is equipped with a start-up and an ignition circuit cut-off switch.

1. The engine can be started only under the following conditions:
 - a. The transmission is in neutral.
 - b. The sidestand is up, the transmission is in gear, and the clutch is disengaged.
2. The motorcycle must not be ridden when the sidestand is down.

⚠ WARNING

Before going through the following steps, check the function of the sidestand switch and clutch switch. (Refer to page 5-15.)

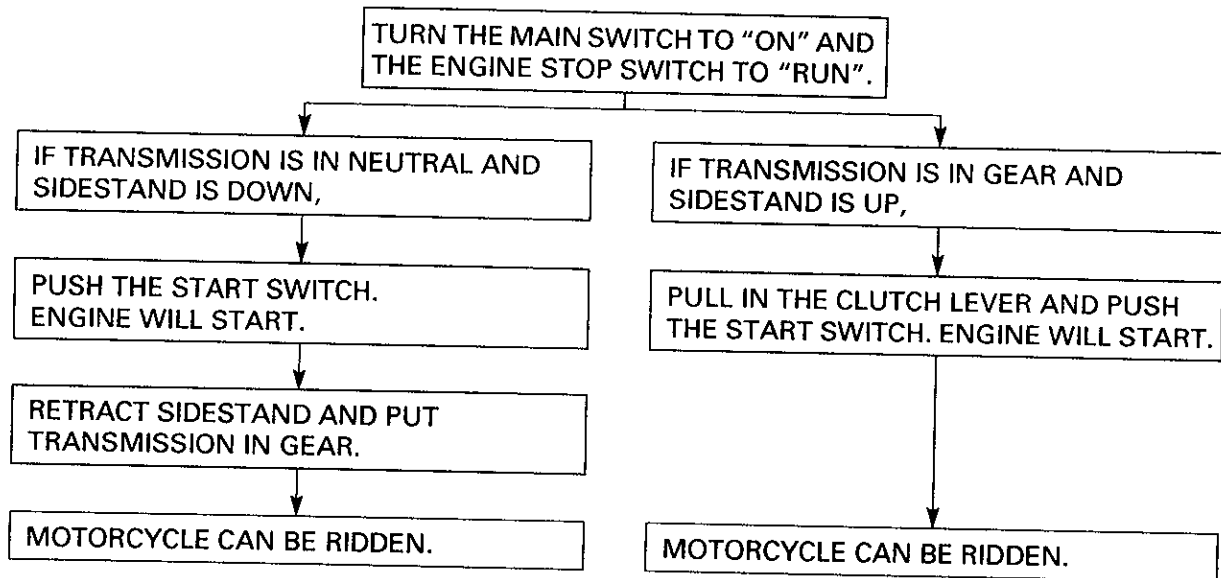

1. Turn the fuel cock to "ON".
2. Turn the main switch to "ON" and the engine stop switch to "RUN".

EUU39903

CAUTION:

If the fuel indicator light comes on, check the fuel level. If necessary, fill the tank with fuel.

3. Shift transmission into neutral.

EUU03001

NOTE:
When the transmission is in neutral, the neutral indicator light should be on. If the light does not come on, ask a Yamaha dealer to inspect it.

4. Turn on the starter "CHOKE" and completely close the throttle grip.
5. Start the engine by pushing the start switch.

EUU02501

NOTE:
If the engine fails to start, release the start switch, wait a few seconds, then try again. Each attempt should be as short as possible to preserve the battery. Do not crank the engine more than 10 seconds on any one attempt.

EUU39802

CAUTION:

The oil level indicator light and fuel indicator light should come on when the start switch is pushed and should go off when the start switch is released. If the oil level indicator light flickers or remains on, immediately stop the engine and check the engine oil level and for oil leakage. If necessary, fill the engine with oil and check to see that the oil level indicator light goes off. If not, consult a Yamaha dealer.

6. After starting the engine, move the starter "CHOKE" halfway back to the warming up position.

EUU02600

NOTE: _____

For maximum engine life, always warm up the engine before starting off. Never accelerate hard with a cold engine.

7. After warming up the engine, turn off the starter completely.

EUU02701

NOTE: _____

The engine is warm when it responds normally to the throttle with the starter "CHOKE" turned off.

EAF10802

Starting a warm engine

The starter "CHOKE" is not required when the engine is warm.

EUU31401

CAUTION: _____

See the "Engine break-in" section prior to operating the motorcycle for the first time.

EAF20003

Shifting

The transmission lets you control the amount of power you have available at a given speed for starting, accelerating, climbing hills, etc. The use of the shift pedal is shown in the illustration. (Page 5-8)
To shift into neutral, depress the shift pedal repeatedly until it reaches the end of its travel, then raise the pedal slightly.

CAUTION:

1. **Do not coast for long periods with the engine off, and do not tow the motorcycle a long distance. Even with gears in neutral, the transmission is only properly lubricated when the engine is running. Inadequate lubrication may damage the transmission.**
 2. **Always use the clutch when changing gears. The engine, transmission, and driveline are not designed to withstand the shock of forced shifting and can be damaged by shifting without using the clutch.**
-

Engine break-in

There is never a more important period in the life of your motorcycle than the period between zero and 1,000 km. For this reason we ask that you carefully read the following material. Because the engine is brand new, you must not put an excessive load on it for the first 1,000 km. The various parts in the engine wear and polish themselves to the correct operating clearances. During this period, prolonged full throttle operation, or any condition which might result in excessive heating of the engine, must be avoided.

1. **0 ~ 150 km:**
Avoid operation above 4,000 r/min. Stop the engine and let it cool for 5 to 10 minutes after every hour of operation. Vary the speed of the motorcycle from time to time. Do not operate it at one set throttle position.

2. 150 ~ 500 km:

Avoid prolonged operation above 5,000 r/min. Rev the motorcycle freely through the gears, but do not use full throttle at any time.

3. 500 ~ 1,000 km:

Avoid prolonged full throttle operation. Avoid cruising speeds in excess of 6,000 r/min.

EUU31800

CAUTION

After 1,000 km of operation, be sure to replace the engine oil, oil filter element, and final gear oil.

4. 1,000 km and beyond:

Full throttle can be used.

EUU38700

CAUTION

Never let engine speeds enter the red zone.

EUU32200

CAUTION

If any engine trouble should occur during the break-in period, consult a Yamaha dealer immediately.

EAF40000

Parking

When parking the motorcycle, stop the engine and remove the ignition key.

EUU63000

! WARNING

The muffler and exhaust pipe are hot. Park the motorcycle in a place where pedestrians or children are not likely to touch the motorcycle. Do not park the motorcycle on a slope or soft ground; the motorcycle may overturn.

PERIODIC MAINTENANCE AND MINOR REPAIR

EAH00400

Periodic inspection, adjustment and lubrication will keep your motorcycle in the safest and most efficient condition possible. Safety is an obligation of the motorcycle owner. The maintenance and lubrication schedule chart should be considered strictly as a guide to general maintenance and lubrication intervals. **YOU MUST TAKE INTO CONSIDERATION THAT WEATHER, TERRAIN, GEOGRAPHICAL LOCATIONS, AND A VARIETY OF INDIVIDUAL USES ALL TEND TO DEMAND THAT EACH OWNER ALTER THIS TIME SCHEDULE TO SHORTER INTERVALS TO MATCH THE ENVIRONMENT.** The most important points of motorcycle inspection, adjustment, and lubrication are explained in the following pages.

EUU63200



If you are not familiar with motorcycle service, this work should be done by a Yamaha dealer.

EAH10101

Tool kit

The service information included in this manual is intended to provide you, the owner, with the necessary information for completing some of your own preventive maintenance and minor repairs. The tools provided in the owner's tool kit are to assist you in the performance of periodic maintenance. However, some other tools such as a torque wrench are also necessary to perform the maintenance correctly.

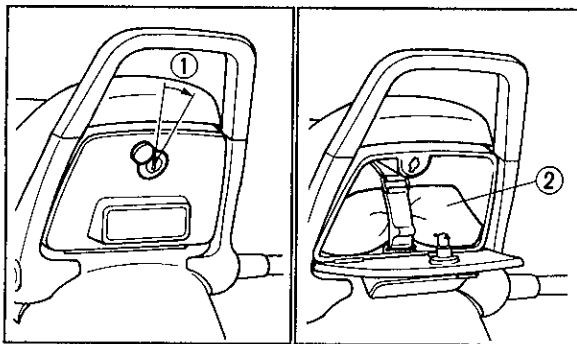

1 Open

2 Tool kit

EUU18500

NOTE:

If you do not have necessary tools required during a service operation, take your motorcycle to a Yamaha dealer for service.

⚠ WARNING

Modifications to this motorcycle not approved by Yamaha may cause loss of performance, and render it unsafe for use. Consult a Yamaha dealer before attempting any changes.

PERIODIC MAINTENANCE / LUBRICATION

ITEM	ROUTINE	BREAK-IN 1,000 km	EVERY	
			6,000 km or 6 months	12,000 km or 12 months
Valves*	<ul style="list-style-type: none"> • Check valve clearance • Adjust if necessary 	○	○	○
Spark plugs	<ul style="list-style-type: none"> • Check condition • Clean or replace if necessary 	○	○	○
Air filter	<ul style="list-style-type: none"> • Clean • Replace if necessary. 		○	○
Carburetor*	<ul style="list-style-type: none"> • Check idle speed/synchronization/starter operation • Adjust if necessary 	○	○	○
Fuel line*	<ul style="list-style-type: none"> • Check fuel hose for cracks or damage. • Replace if necessary 		○	○
Engine oil	<ul style="list-style-type: none"> • Replace (Warm engine before draining). 	○	○	○
Engine oil filter*	<ul style="list-style-type: none"> • Replace 	○		○
Final gear oil	<ul style="list-style-type: none"> • Check oil level/oil leakage. • Replace every 24,000 km or 24 months 	Replace	○	○
Front brake*	<ul style="list-style-type: none"> • Check operation/fluid leakage/See NOTE (page 8-5) • Correct if necessary 		○	○
Rear brake	<ul style="list-style-type: none"> • Check operation. • Adjust if necessary. 		○	○
Clutch	<ul style="list-style-type: none"> • Check operation. • Adjust if necessary. 		○	○

ITEM	ROUTINE	BREAK-IN 1,000 km	EVERY	
			6,000 km or 6 months	12,000 km or 12 months
Swingarm pivot*	<ul style="list-style-type: none"> • Check swingarm assembly for looseness • Correct if necessary • Moderately repack every 24,000 km or 24 months ** 			○
Wheels*	<ul style="list-style-type: none"> • Check balance/damage/runout • Replace if necessary 		○	○
Wheel bearings*	<ul style="list-style-type: none"> • Check bearing assembly for looseness/damage • Replace if damaged 		○	○
Steering bearings*	<ul style="list-style-type: none"> • Check bearing assembly for looseness • Correct if necessary • Moderately repack every 24,000 km or 24 months ** 	○		○
Front forks*	<ul style="list-style-type: none"> • Check operation/oil leakage • Repair if necessary 		○	○
Rear shock absorbers*	<ul style="list-style-type: none"> • Check operation/oil leakage • Repair if necessary 		○	○
Fittings/Fasteners*	<ul style="list-style-type: none"> • Check all chassis fittings and fasteners. • Correct if necessary 	○	○	○
Center and sidestand*	<ul style="list-style-type: none"> • Check operation. • Repair if necessary 	○	○	○
Sidestand switch*	<ul style="list-style-type: none"> • Check operation • Clean or replace if necessary 	○	○	○
Battery*	<ul style="list-style-type: none"> • Check specific gravity • Check breather pipe for proper operation. • Correct if necessary 		○	○

* It is recommended that these items be serviced by a Yamaha dealer

** Lithium soap base grease

NOTE:

Brake fluid replacement.

1. When disassembling the master cylinder or caliper cylinder, replace the brake fluid. Normally check the brake fluid level and fill the master cylinder with fluid as required.
 2. On the inner parts of the master cylinder and caliper cylinder, replace the oil seals every two years.
 3. Replace the brake hoses every four years, or if cracked or damaged.
-

Torque specifications

Use a torque wrench to tighten these items. It is recommended that these items be checked occasionally, especially before a long trip. Always check the tightness of these items whenever they are loosened for any reason.

Item	Torque	
	Nm	m kg
Spark plug	20	2.0
Engine oil drain plug	43	4.3
Oil filter bolt	10	1.0
Final gear oil drain plug	23	2.3
Front fork brace bolt	9	0.9
Front axle pinch bolt	20	2.0
Front wheel axle	105	10.5
Rear wheel axle nut	105	10.5
Rear axle pinch bolt	20	2.0
Tension bar bolt	20	2.0

A (Nut)	B (Bolt)	General torque specifications	
		Nm	m·kg
10 mm	6 mm	6	0.6
12 mm	8 mm	15	1.5
14 mm	10 mm	30	3.0
17 mm	12 mm	55	5.5
19 mm	14 mm	85	8.5
22 mm	16 mm	130	13.0

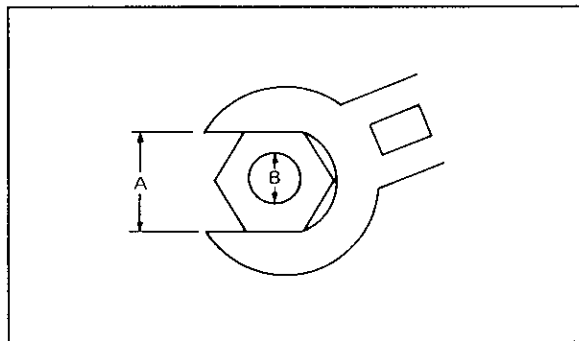

Engine oil

1. Oil level inspection
 - a. Place the motorcycle on the center-stand. Warm up the engine for several minutes.

EUU03901

NOTE:

Be sure the motorcycle is positioned straight up when checking the oil level. A slight tilt toward the side can result in false readings.

- b. With the engine stopped, check the oil level through the level window located at the lower part of the left side crankcase cover.

EUU04000

NOTE:

Wait a few minutes until the oil level settles before checking.

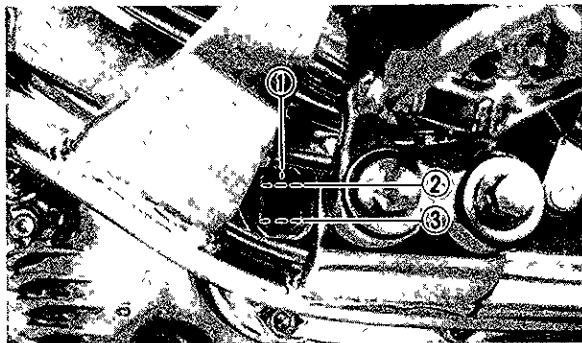

1. Level window
2. Maximum mark
3. Minimum mark

- c. The oil level should be between the maximum and minimum marks. If the level is low, fill engine with sufficient oil to raise it to the specified level.
2. Engine oil and oil filter element replacement
 - a. Warm up the engine for a few minutes.
 - b. Stop the engine. Place an oil pan under the engine and remove the oil filler cap.

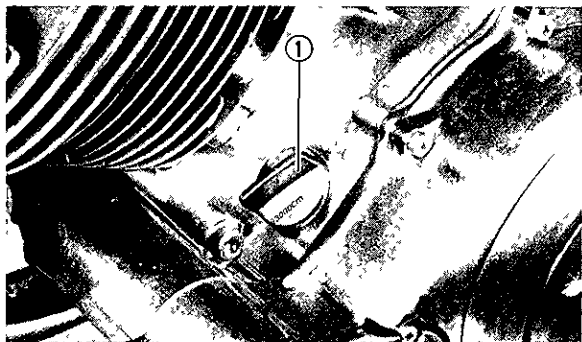

1 Oil filler cap

c. Remove the drain plug and drain the oil.

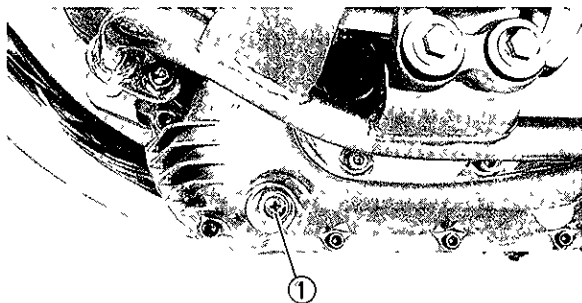

1 Drain plug

d. Remove the oil filter cover bolts and oil filter.

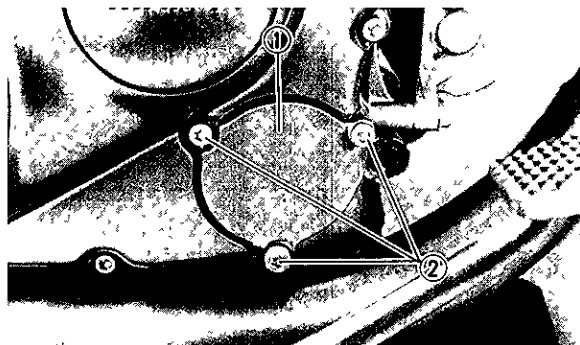

1 Oil filter cover

2 Oil filter bolt (× 3)

e. Reinstall the drain plug and tighten it to the specified torque.

Tightening torque:

Drain plug:

43 Nm (4.3 m·kg)

- f. Install the new oil filter, O-rings and the filter cover. Tighten the oil filter cover bolts to the specified torque.

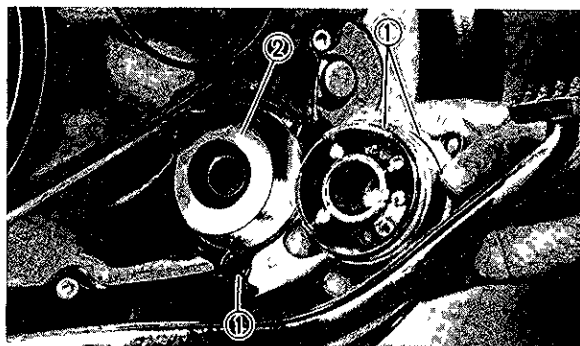

1 Proper O-ring position

2 Oil filter

Tightening torque:

Oil filter cover bolt:
10 Nm (1.0 m·kg)

EUU20300

NOTE:

Make sure the O-rings are seated properly.

- g. Fill engine with oil. Install the oil filler cap and tighten.

Recommended oil:

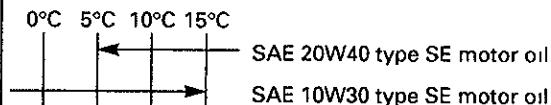

Recommended engine oil classification:

API Service "SE", "SF" type or equivalent
(e.g. "SF-SE", "SF-SE-CC", "SF-SE-SD" etc.)

Oil quantity:

Total amount:

3.6 L

Periodic oil change:

3.0 L

With oil filter replacement:

3.1 L

CAUTION

- Do not put in any chemical additives. Engine oil also lubricates the clutch and additives could cause clutch slippage.
- Be sure no foreign material enters the crankcase.

-
- h. Start the engine and warm up for a few minutes. While warming up, check for oil leakage. If oil leakage is found, stop the engine immediately, and check for the cause.
- i. After the engine is started, the oil level indicator light should go off if oil is filled to specified level.

CAUTION

If the indicator light flickers or remains on, immediately stop the engine and consult a Yamaha dealer.

Final gear oil**⚠ WARNING**

Do not let foreign material enter the final gear case. Be sure oil does not get on the tire or wheel.

1. Oil level inspection
 - a. Place the motorcycle on a level place and place it on the centerstand. The engine should be cool at ambient temperature.
 - b. Remove the oil filler bolt and check the oil level. The oil level should be at the brim of the hole. Fill with oil as necessary.

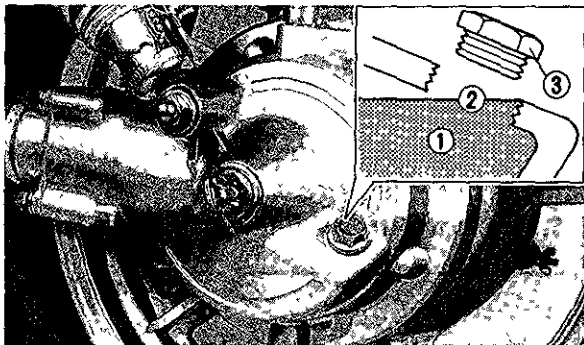

1. Final gear oil
 2. Correct oil level
 3. Oil filler bolt

2. Gear oil replacement

- a. Place an oil pan under the final gear case.
- b. Remove the oil filler bolt and the drain plug to drain the oil.
- c. Reinstall and tighten the drain plug to the specified torque.

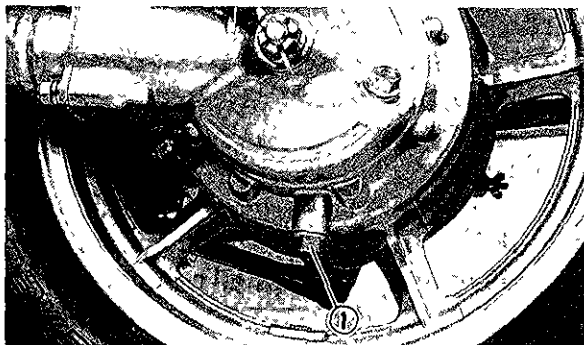

1. Drain plug

Tightening torque:

Drain plug:

23 Nm (2.3 m·kg)

- d. Fill the gear case to the brim of the hole with the recommended oil.

Oil capacity:

Final gear case:

0.2 L

Recommended oil:

SAE 80 API GL-4 Hypoid gear oil

If desired, an SAE 80W90 hypoid gear oil may be used for all conditions.

EUU02300

NOTE:

"GL-4" is a quality and additive rating.

"GL-5" or "GL-6" rated hypoid gear oils may also be used.

- e. Reinstall and tighten the oil filler bolt to the specified torque.

Tightening torque:

Oil filler bolt:

23 Nm (2.3 m·kg)

- f. After replacement of the final gear oil, be sure to check for oil leaks.

EAH61302

Air filter

The air filter element should be cleaned at the specified intervals. It should be cleaned more frequently if you are riding in unusually wet or dusty areas.

1. Remove the air filter case assembly.

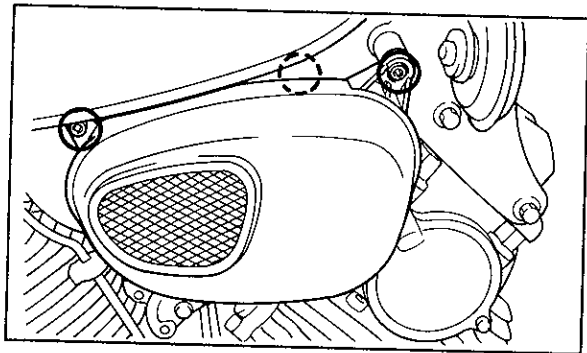

2. Remove the air filter case cover.

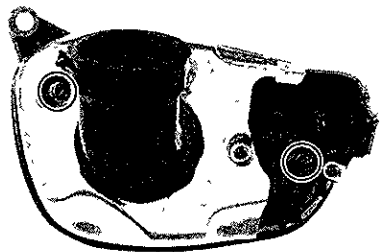

3. Remove the element.

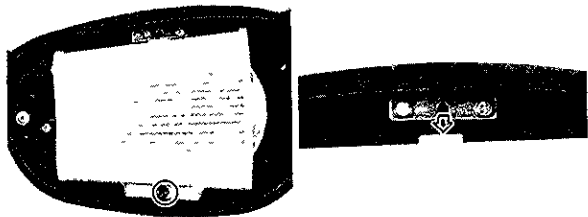

4. Tap the element lightly to remove most of the dust and dirt. Blow out the remaining dirt with compressed air as shown. If the element is damaged, replace it.



5. Reassemble by reversing the removal procedure.

EUU35701

CAUTION

Make sure the element is properly seated in the filter case.

CAUTION

The engine should never be run without the air filter element installed; excessive piston and/or cylinder wear may result.

Carburetor adjustment

The carburetors are important parts of the engine and require very sophisticated adjustment. Most adjustments should be left to a Yamaha dealer who has the professional knowledge and experience to do so. However, the idle speed may be adjusted by the owner as part of routine maintenance.

CAUTION

The carburetors were set at the Yamaha factory after many tests. If they are changed, poor engine performance and damage may result.

Idle speed adjustment

1. Start the engine and warm it up for a few minutes (normally, 1 or 2 minutes) at approximately 1,000 to 2,000 r/min. Occasionally rev the engine to 4,000 to 5,000 r/min. The engine is warm when it quickly responds to the throttle.
2. Set the idle to the specified engine speed by adjusting the throttle stop screw; turn the screw in to increase engine speed, and out to decrease engine speed.

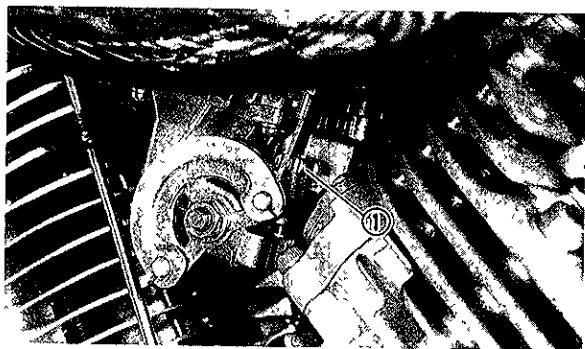

1 Throttle stop screw

Standard idle speed:
950 ~ 1,050 r/min

EUU04500

NOTE:

If the specified idle speed cannot be obtained by performing the above adjustment, consult a Yamaha dealer.

EAH92200

Throttle cable adjustment

EUU06400

NOTE:

Before adjusting the throttle cable free play, the engine idling speed should be adjusted.

The throttle cable should have a specified free play in the turning direction at the grip flange. If the free play is incorrect, ask a Yamaha dealer to make adjustment.

Free play:
3 ~ 5 mm

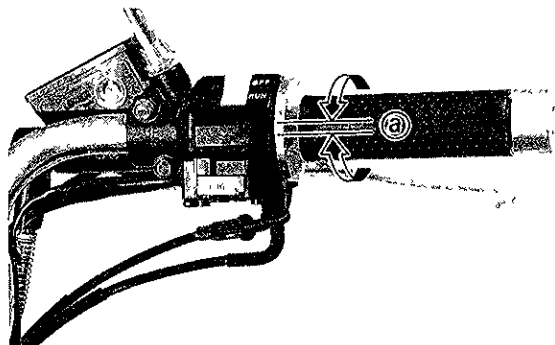

a Free play

Valve clearance adjustment

The correct valve clearance changes with use, resulting in improper fuel/air supply or engine noise. To prevent this, the valve clearance must be adjusted regularly. This adjustment however, should be left to a professional Yamaha service technician.

Spark plug inspection

The spark plug is an important engine component and is easy to inspect. The condition of the spark plug can indicate the condition of the engine.

Normally, all spark plugs from the same engine should have the same color on the white insulator around the center electrode. The ideal color at this point is a medium-to-light tan color for a motorcycle that is being ridden normally. If one spark plug shows a distinctly different color, there could be something wrong with the engine.

Do not attempt to diagnose such problems yourself. Instead, take the motorcycle to a Yamaha dealer. You should periodically remove and inspect the spark plugs because heat and deposits will cause any spark plug to slowly break down and erode. If electrode erosion becomes excessive, or if carbon and other deposits are excessive, you should replace the spark plug with the specified plug.

Specified spark plug:
BPR7ES (NGK) or
W22EPR-U (NIPPONDENSO)

Before installing any spark plug, measure the electrode gap with a wire thickness gauge. Adjust the gap to specification.

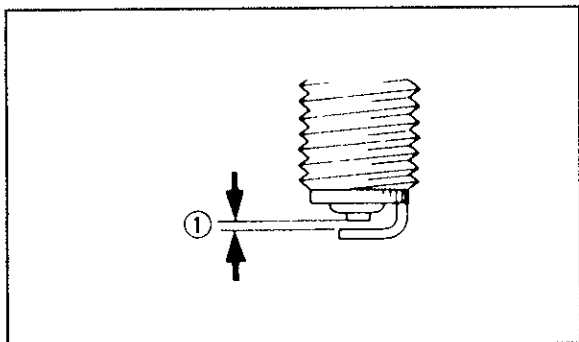

1. Spark plug gap

Spark plug gap:
0.7 ~ 0.8 mm

When installing the spark plug, always clean the gasket surface and use a new gasket. Wipe off any grime from the threads and tighten the spark plug to the specified torque.

Tightening torque:
Spark plug:
20 Nm (2.0 m·kg)

EUU03802

NOTE:

If a torque wrench is not available when you are installing a spark plug, a good estimate of the correct torque is 1/4 to 1/2 turn past finger tight. Have the spark plug tightened to the specified torque as soon as possible.

Front brake lever free play adjustment

The free play at the front brake lever should be 2 ~ 5 mm.

1. Loosen the locknut.
2. Turn the adjusting bolt so that the brake lever movement is 2 ~ 5 mm before the bolt contacts the master cylinder piston.
3. After adjusting, tighten the locknut.

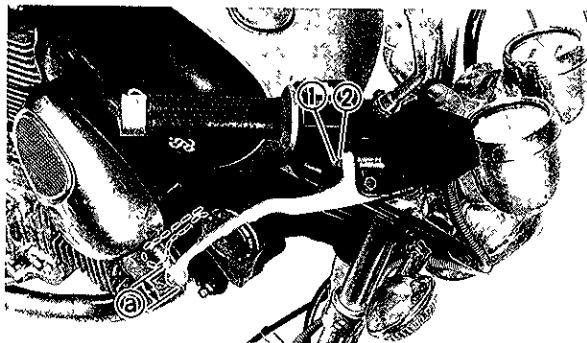

1 Adjuster

2 Locknut

a 2~5 mm

WARNING

- Check the brake lever free play. Be sure the brake is working properly.
- A soft or spongy feeling in the brake lever can indicate the presence of air in the brake system. This air must be removed by bleeding the brake system before the motorcycle is operated. Air in the system will cause greatly diminished braking capability and can result in loss of control and an accident. Have a Yamaha dealer inspect and bleed the system if necessary.

Rear brake pedal height and free play adjustment

EUU64301

⚠ WARNING

It is advisable to have a Yamaha dealer make this adjustment.

1. Pedal height
 - a. Loosen the locknut.
 - b. By turning the adjusting bolt clockwise or counterclockwise, adjust the brake pedal position as shown.
 - c. Tighten the locknut.

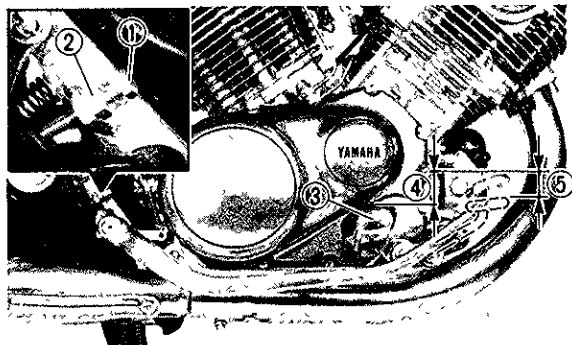

1. Adjuster (for pedal height)
2. Locknut
3. Footrest
4. Pedal height: 40 mm
5. Free play: 20~30 mm

EUU64400

⚠ WARNING

After adjusting the pedal height adjust brake pedal free play.

2. Free play

The rear brake pedal free play should be adjusted to 20 ~ 30 mm at the brake pedal end. Turn the adjusting nut on the brake rod in direction ① to reduce free play or in direction ② to increase free play.

EUU64500

WARNING

Check the operation of the brake light after adjusting the rear brake.

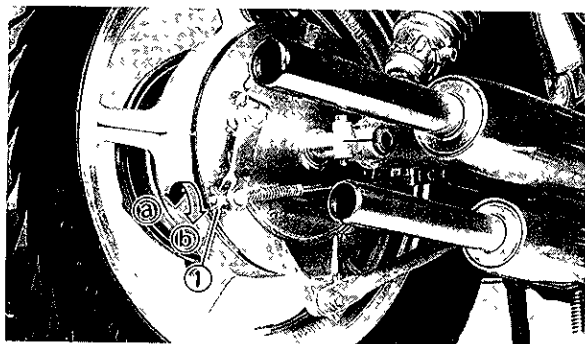

1 Adjuster

EAH83301

Brake light switch adjustment

The brake light switch is operated by movement of the brake pedal. To adjust, hold the main body of the switch so it does not rotate and turn the adjusting nut. Proper adjustment is achieved when the brake light comes on just before the brake begins to take effect.

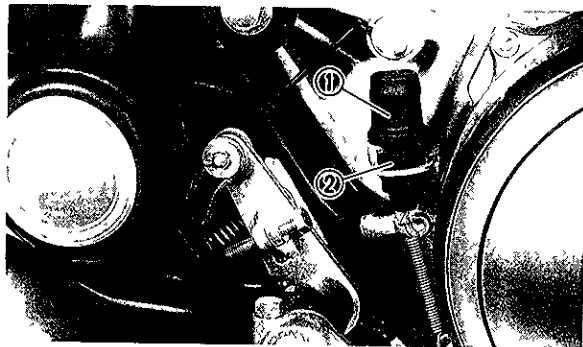

1 Main body

2 Adjusting nut

Checking the front brake pads and rear brake shoes

A wear indicator is provided on each brake. This indicator allows checking of brake pad/shoe wear without disassembling the brake.

FRONT

Apply the brake and inspect the wear indicator. If the brake pads are worn to the wear limit, have a Yamaha dealer replace the pads.

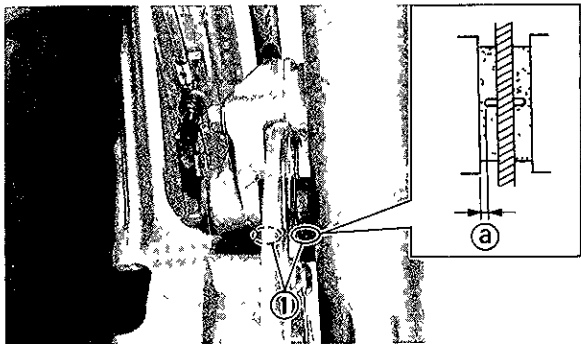

1 Wear indicator

a. Wear limit 0.5 mm

REAR

Apply the brake and inspect the wear indicator.

If the indicator reaches the wear limit line, ask a Yamaha dealer to replace the shoes.

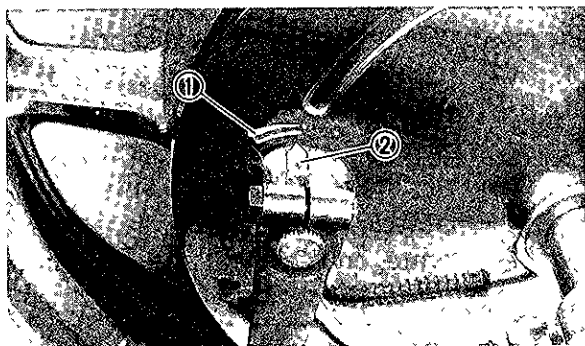

1. Wear limit

2 Wear indicator

Inspecting the brake fluid level

Insufficient brake fluid may let air enter the brake system, possibly causing the brakes to become ineffective.

Before riding, check that the brake fluid is above the minimum level and fill when necessary. Observe these precautions:

1. When checking the fluid level, make sure the top of the master cylinder is level by turning the handlebars.
2. Use only the designated quality brake fluid. Otherwise, the rubber seals may deteriorate, causing leakage and poor brake performance.

Recommended brake fluid: DOT 4

EUU13100

NOTE:

If DOT 4 is not available, DOT 3 can be used.

3. Refill with the same type of brake fluid. Mixing fluids may result in a harmful chemical reaction and lead to poor brake performance.

4. Be careful that water does not enter the master cylinder when refilling. Water will significantly lower the boiling point of the fluid and may result in vapor lock.
5. Brake fluid may deteriorate painted surfaces or plastic parts. Always clean up spilled fluid immediately.
6. Have a Yamaha dealer check the cause if the brake fluid level goes down.

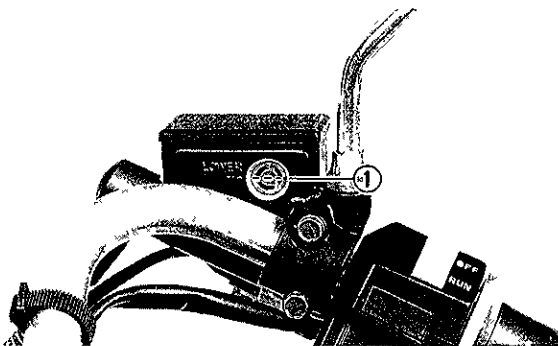

1 Lower level

Brake fluid replacement

1. Complete fluid replacement should be done only by trained Yamaha service personnel.
2. Have a Yamaha dealer replace the following components during periodic maintenance or when they are damaged or leaking.
 - a. Replace all rubber seals every two years.
 - b. Replace all hoses every four years.

Clutch lever free play adjustment

The clutch lever free play should be adjusted to 8 ~ 12 mm. If the free play is incorrect, adjust as follows.

<p>Free play: 8 ~ 12 mm</p>

1. Loosen the locknut.
2. Turn the adjusting bolt in or out until specified lever free play is obtained.
3. Tighten the locknut.

NOTE:

If proper adjustment cannot be obtained or the clutch does not work correctly, ask a Yamaha dealer to inspect the internal clutch mechanism.

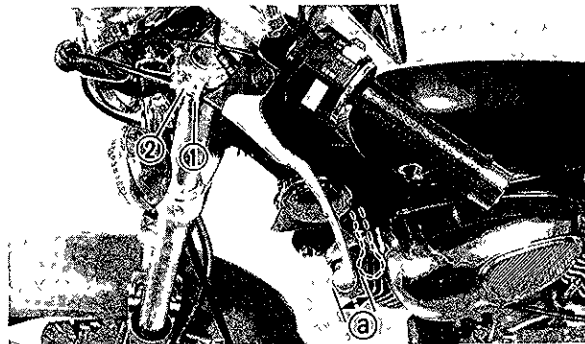

1. Locknut 2. Adjuster a. 8~12 mm

Cable inspection and lubrication

EUU64601

⚠ WARNING

Damage to the outer housing of cables may allow internal rusting and cause interference with cable movement. Replace damaged cables as soon as possible to prevent unsafe conditions.

Lubricate the inner cable and the cable end. If it does not operate smoothly, ask a Yamaha dealer to replace them.

Recommended lubricant:
SAE 10W30 motor oil

Throttle cable and grip lubrication

The throttle twist grip assembly should be greased at the time that the cable is lubricated, since the grip must be removed to get at the end of the throttle cable. After removing the screws, hold the end of the cable up in the air and put in several drops of lubricant. With the throttle grip disassembled, coat the metal surface of the grip assembly with a suitable all-purpose grease.

Brake and shift pedal lubrication

Lubricate the pivoting parts.

Recommended lubricant:
SAE 10W30 motor oil

EAI30701

Brake and clutch lever lubrication

Lubricate the pivoting parts.

Recommended lubricant:
SAE 10W30 motor oil

EAI30803

Center and sidestand lubrication

Lubricate the pivoting and mating joints. Check to see that the center and sidestand move up and down smoothly.

Recommended lubricant:
SAE 10W30 motor oil

EUU69301

⚠ WARNING

If the center and/or sidestand does not move smoothly, consult a Yamaha dealer.

EAI20502

Front fork inspection

EUU66700

⚠ WARNING

Securely support the motorcycle so there is no danger of it falling over.

1. Visual check
Check for scratches or damage on the inner tube and excessive oil leakage from the front fork.
2. Operation check
Place the motorcycle on a level place.
 - a. Hold the motorcycle in an upright position and apply the front brake.
 - b. Push down hard on the handlebars several times and check if the fork rebounds smoothly.

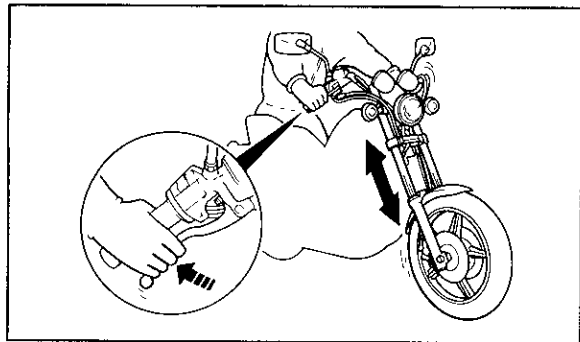

EUU42500

CAUTION

If any damage or unsmooth movement is found with the front fork, consult a Yamaha dealer.

EAI50902

Rear shock absorber adjustment

Each shock absorber is equipped with a spring preload adjuster.

Adjust spring preload as follows.

Turn adjuster in direction ① to increase spring preload and in direction ② to decrease spring preload.

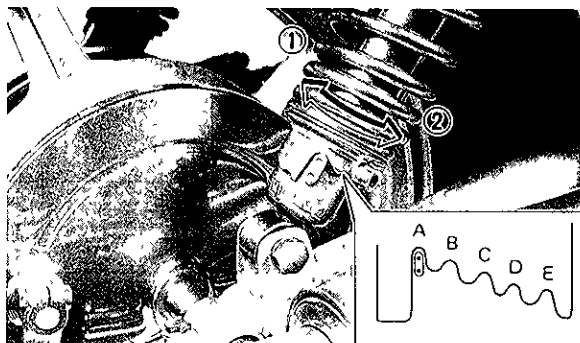

A Softest

E Stiffest

EUU65200

⚠ WARNING

Always adjust each shock absorber to the same setting. Uneven adjustment can cause poor handling and loss of stability.

Steering inspection

Periodically inspect the condition of the steering. Worn out or loose steering bearings may be dangerous. Place a stand under the engine to raise the front wheel off the ground. Hold the lower end of the front forks and try to move them forward and backward. If any free play can be felt, ask a Yamaha dealer to inspect and adjust the steering. Inspection is easier if the front wheel is removed.

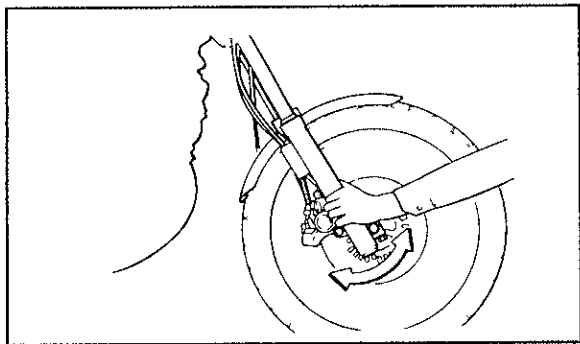

⚠ WARNING

Securely support the motorcycle so there is no danger of it falling over.

Wheel bearings

If there is play in the front or rear wheel hub or if the wheel does not turn smoothly, have a Yamaha dealer inspect the wheel bearings. The wheel bearings should be inspected according to the Maintenance Schedule.

Battery

Check the level of the battery electrolyte and make sure that the terminals are tight. Fill with distilled water if the electrolyte level is low.

EUU33601

CAUTION:

When inspecting the battery, be sure the breather pipe is routed correctly. If the breather pipe is positioned in such a way as to cause battery electrolyte or gas to exit onto the frame, structural and cosmetic damage to the motorcycle can occur.

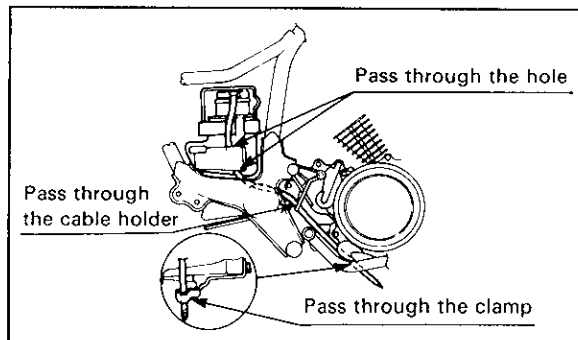

! WARNING

Battery electrolyte is poisonous and dangerous, causing severe burns, etc. It contains sulfuric acid. Avoid contact with skin, eyes or clothing.

Antidote:

EXTERNAL: Flush with water.

INTERNAL: Drink large quantities of water or milk. Follow with milk of magnesia, beaten egg, or vegetable oil. Call a physician immediately.

EYES: Flush with water for 15 minutes and get prompt medical attention. Batteries produce explosive gases. Keep sparks, flame, cigarettes etc., away. Ventilate when charging or using in an enclosed space. Always shield your eyes when working near batteries.

KEEP OUT OF REACH OF CHILDREN.

Replenishing the battery fluid

A poorly maintained battery will corrode and discharge quickly. The battery fluid should be checked at least once a month. The level should be between the minimum and maximum marks. Use only distilled water if refilling is necessary.



1 Upper level

2. Lower level

CAUTION

Normal tap water contains minerals which are harmful to a battery; therefore, refill only with distilled water.

Storage

1. When the motorcycle will not be used for a month or longer, remove the battery and store it in a cool, dark place. Completely recharge the battery before reusing.
2. If the battery will be stored for longer than two months, check the specific gravity of the fluid at least once a month and recharge the battery when it is too low.
3. Always make sure the connections are correct when putting the battery back in the motorcycle. Make sure the breather pipe is properly connected and is not damaged or obstructed.

Fuse replacement

1. There is a main fuse case and sub fuse block on this motorcycle. The main fuse case is located under the seat. The sub fuse block is located under the indicator lights panel.
2. If any fuse is blown, turn off the main switch and the switch of the circuit in question. Install a new fuse of specified amperage. Turn on the switches and see if the electrical device operates.
If the fuse immediately blows again, consult a Yamaha dealer.

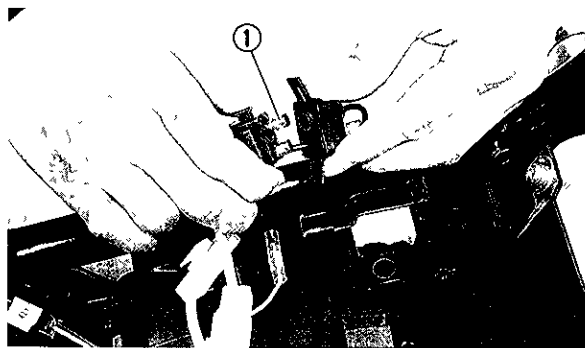

1 Main fuse

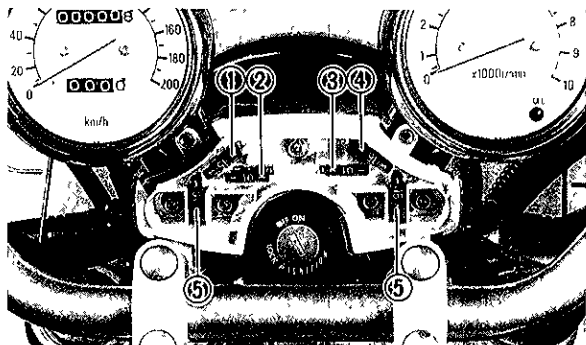

- | | |
|---------------|-------------|
| 1 Signal | 2 Ignition |
| 3 Taillight | 4 Headlight |
| 5 Spare (x 2) | |

CAUTION:

Do not use fuses of higher amperage rating than those recommended. Substitution of a fuse of improper rating can cause extensive electrical system damage and possibly a fire.

Specified fuse:

Main:	20 A
Head:	15 A
Signal:	15 A
Taillight:	10 A
Ignition:	10 A

Headlight bulb replacement

This motorcycle is equipped with a quartz bulb headlight.

If the headlight bulb burns out, replace the bulb as follows:

1. Remove the screws holding the light unit assembly.

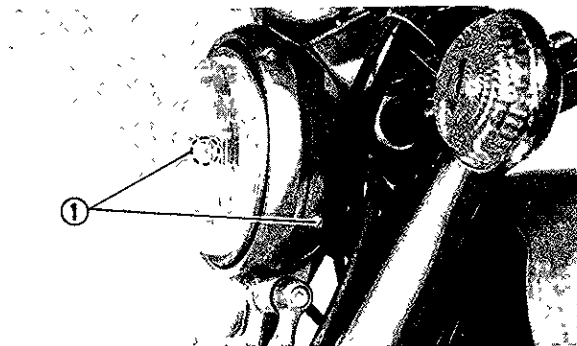

1 Holding screw (x 2)

2. Remove the headlight connectors, remove the light unit assembly and then the bulb holder cover.



1 Bulb holder cover

3. Turn the bulb holder counterclockwise to remove it and remove the defective bulb.

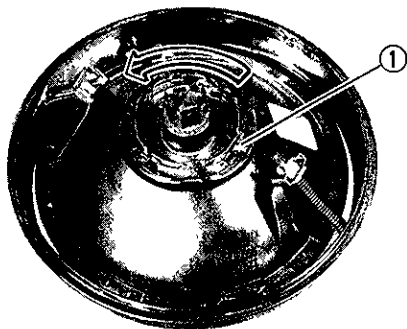

1 Bulb holder

EUU66001

⚠ WARNING

Keep flammable products and your hands away from the bulb while it is on, as it is hot. Do not touch the bulb until it cools down.

4. Put a new bulb into position and secure it in place with the bulb holder.

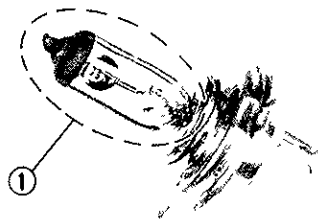

1. Don't touch

EUU34100

CAUTION

Avoid touching the glass part of the bulb. Keep it free from oil; otherwise, the transparency of the glass, life of the bulb, and illuminous flux will be adversely affected. If oil gets on the bulb, thoroughly clean it with a cloth moistened with alcohol or lacquer thinner.

5. Install the bulb holder cover, headlight connectors and the light unit assembly. If the headlight beam adjustment is necessary, ask a Yamaha dealer to make adjustment.

EAJ21904

Front wheel removal

EUU66202

! WARNING

- It is advisable to have a Yamaha dealer service the wheel.
- Securely support the motorcycle so there is no danger of it falling over.

1. Place the motorcycle on the center-stand.
2. Remove the speedometer cable from the front wheel side.

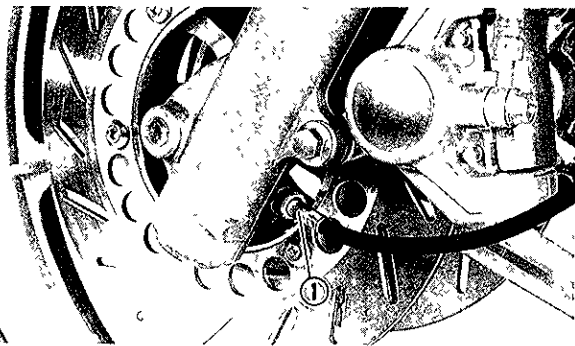

1. Speedometer cable

3. Remove the front fork brace together with the fender.

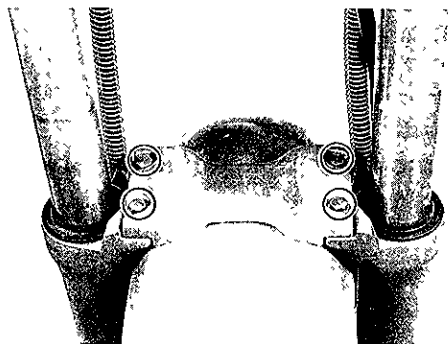

4. Loosen the pinch bolt.

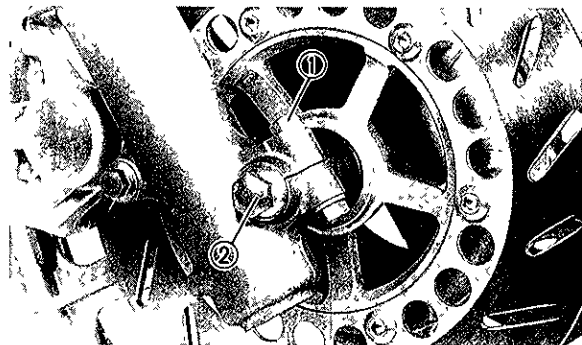

1 Pinch bolt

2 Wheel axle

5. Remove the wheel axle. Make sure the motorcycle is properly supported.

EUU05401

NOTE:

Do not depress the brake lever when the disc and caliper are separated.

6. Lower the wheel until the discs come off the calipers. Turn the calipers outward so they do not obstruct the wheel, then remove the wheel.

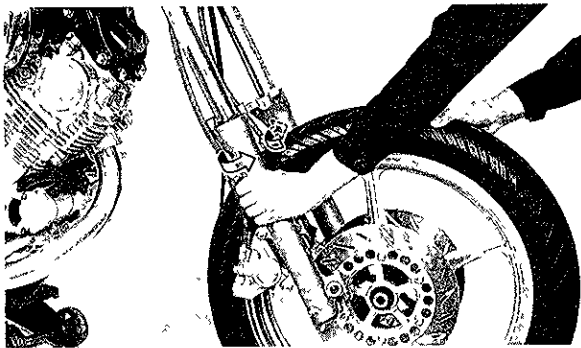

EAJ28501

Front wheel installation

When installing the front wheel, reverse the removal procedure. Pay attention to the following points:

1. Make sure the wheel hub and the speedometer gear unit housing are installed with the projections meshed into the slots.

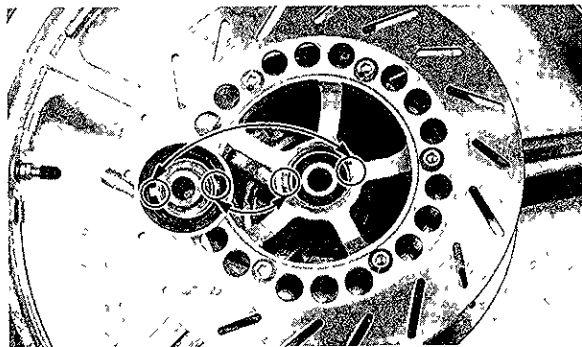

2. Make sure there is enough gap between the brake pads before inserting the brake discs.
3. Make sure the slot in the speedometer gear unit housing fits over the stopper on the front fork outer tube.



4. Tighten the wheel axle to the specified torque.

Tightening torque:

Wheel axle

105 Nm (10.5 m·kg)

5. Before tightening the pinch bolt, push down hard on the handlebars several times to check for proper fork operation.
6. Tighten the pinch bolt to the specified torque.

Tightening torque:

Pinch bolt

20 Nm (2.0 m·kg)

7. Tighten the front fork brace bolts to the specified torque.

Tightening torque:

Front fork brace bolt

9 Nm (0.9 m·kg)

EAJ31503

Rear wheel removal

EUU66201

⚠ WARNING

It is advisable to have a Yamaha dealer service the wheel.

EUU65700

⚠ WARNING

Securely support the motorcycle so there is no danger of it falling over.

1. Place the motorcycle on the center-stand.
2. Remove the cotter pin, nut and tension bar bolt from the brake shoe plate.

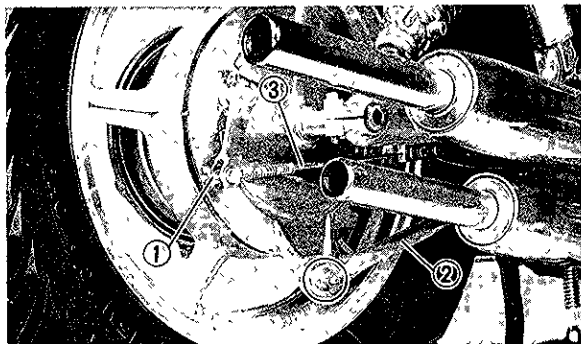

1 Adjuster 2. Tension bar 3. Brake rod

3. Remove the brake adjusting nut and brake rod from the brake cam lever.

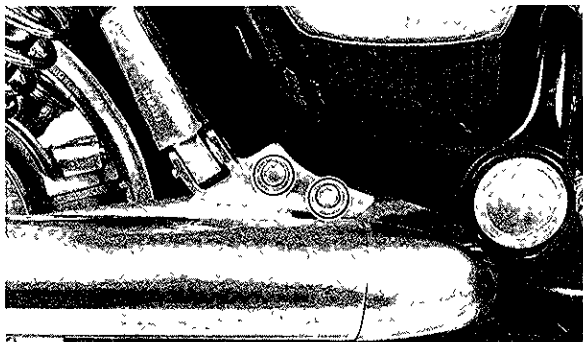

4. Remove the axle nut cotter pin and the axle nut.

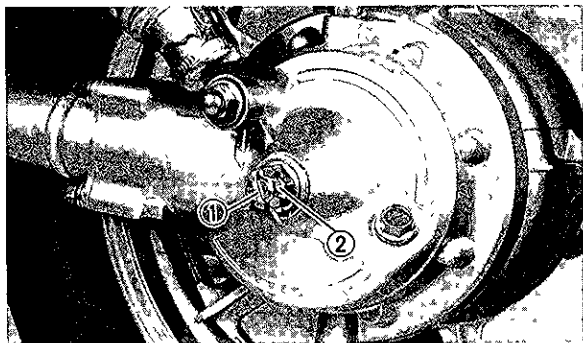

1. Cotter pin 2. Axle nut

- Loosen the wheel axle pinch bolt and pull out the wheel axle.

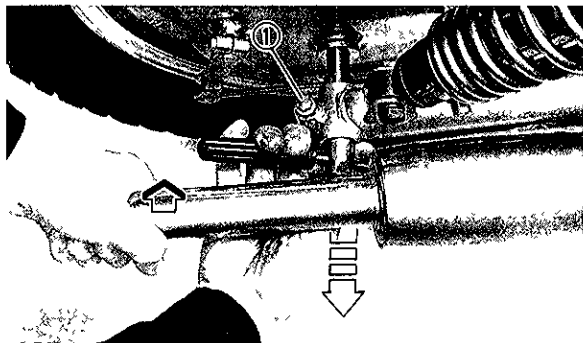

1 Pinch bolt

- Move the wheel to the right to separate it from the final gear case and remove the rear wheel.

Rear wheel installation

When installing the rear wheel, reverse the removal procedure. Pay attention to the following points:

- Apply a light coating of lithium base grease to final gear case splines and rear wheel hub splines.
- Make sure the splines on the wheel hub fit into the final gear case.

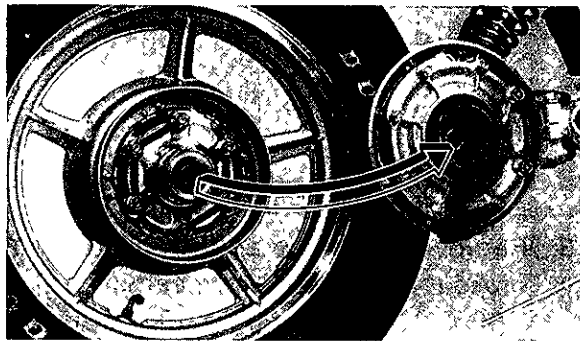

- Tighten the following parts to the specified torque, and make sure a new cotter pin is installed.

⚠ WARNING**Always use a new cotter pin.**

Tightening torque:

Axle nut:

105 Nm (10.5 m·kg)

Tension bar bolt:

20 Nm (2.0 m·kg)

Pinch bolt:

20 Nm (2.0 m·kg)

- Adjust the rear brake free play. (see page 8-19)

⚠ WARNING**Check the operation of the brake light after adjusting the rear brake.****Troubleshooting**

Although Yamaha motorcycles receive a rigid inspection before shipment from the factory, trouble may occur during operation.

Any problem in the fuel, compression, or ignition systems can cause poor starting and loss of power. The troubleshooting chart describes a quick, easy procedure for making checks.

If your motorcycle requires any repair, bring it to a Yamaha dealer. The skilled technicians at a Yamaha dealership have the tools, experience, and know-how to properly service your motorcycle. Use only genuine Yamaha parts on your motorcycle. Imitation parts may look like Yamaha parts, but they are often inferior. Consequently, they have a shorter service life and can lead to expensive repair bills.

Troubleshooting chart

⚠ WARNING

Never check the fuel system while smoking or in the vicinity of an open flame.

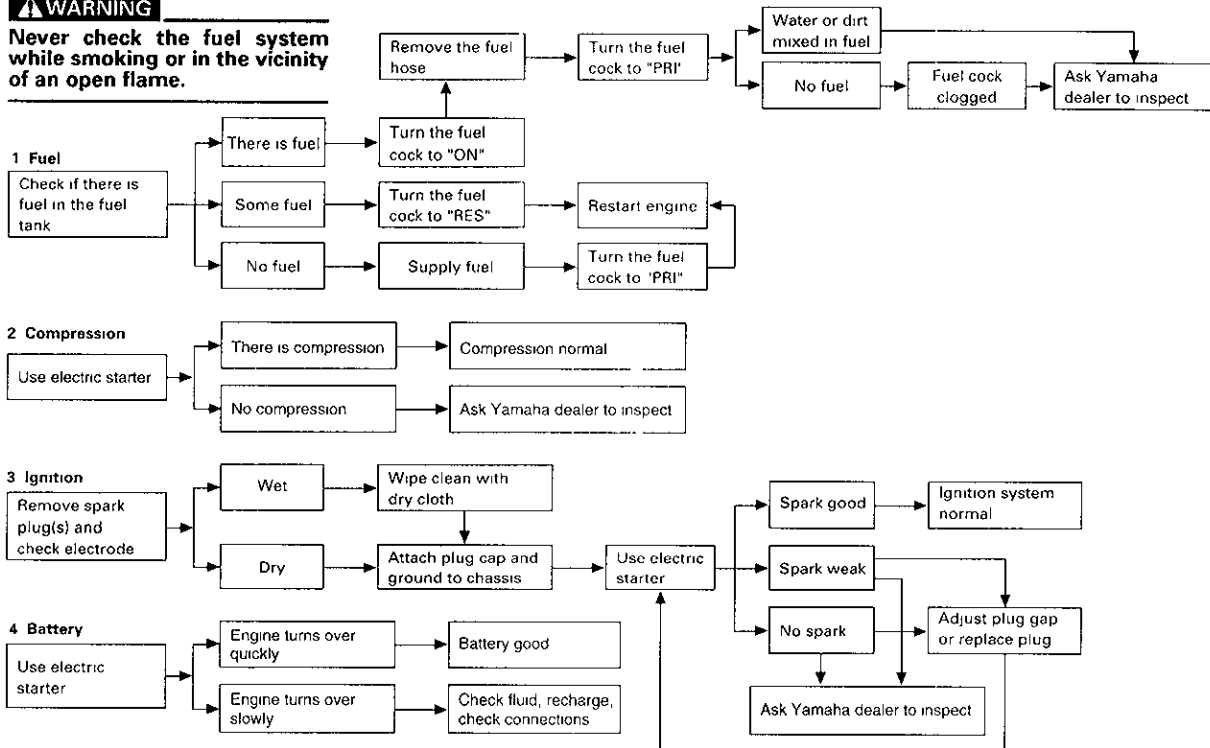

CLEANING AND STORAGE

A. CLEANING

Frequent, thorough cleaning of your motorcycle will not only enhance its appearance but will improve its general performance and extend the useful life of many components.

1. Before cleaning the motorcycle:
 - a. Block off the end of the exhaust pipes to prevent water entry; a plastic bag and strong rubber band may be used.
 - b. Make sure the spark plugs and all filler caps are properly installed.
2. If the engine case is excessively greasy, apply degreaser with a paint brush. Do not apply degreaser to wheel axles.
3. Rinse the dirt and degreaser off with a garden hose. Use only enough pressure to do the job.

CAUTION

Excessive hose pressure may cause water seepage and deterioration of wheel bearings, front fork, brakes, transmission seals and electrical parts.

Many expensive repair bills have resulted from improper high pressure detergent applications such as those available in coin-operated car washers.

4. Once the majority of the dirt has been hosed off, wash all surfaces with warm water and mild, detergent-type soap. An old toothbrush or bottle brush is handy for hard-to-get-at places.
5. Rinse the motorcycle off immediately with clean water and dry all surfaces with a chamois, clean towel, or soft absorbent cloth.

- Clean the seat with a vinyl upholstery cleaner to keep the cover pliable and glossy.
- Automotive-type wax may be applied to all painted and chrome-plated surfaces. Avoid combination cleaner-waxes. Many contain abrasives which may mar the paint or protective finish. When finished, start the engine and let it idle for several minutes.

EAK02400

B. STORAGE

Long term storage (60 days or more) of your motorcycle will require some preventive procedures to guard against deterioration. After thoroughly cleaning the motorcycle, prepare for storage as follows:

- Drain the fuel tank, fuel lines, and carburetor float bowls.

- Remove the empty fuel tank, pour a cup of SAE 10W30 or 20W40 motor oil in the tank, shake the tank to coat the inner surfaces thoroughly and drain off the excess oil. Reinstall the tank.
- Remove the spark plugs, pour about one tablespoon of SAE 10W30 or 20W40 motor oil in each spark plug hole and reinstall the spark plugs. Turn the engine over several times (ground spark plug leads) to coat the cylinder walls with oil.

EUU66400

WARNING

When using the starter motor to crank the engine, remove the spark plug wires, and ground them to prevent sparking.

- Lubricate all control cables.
- Block up the frame to raise both wheels off the ground.

6. Tie a plastic bag over the exhaust pipe outlets to prevent moisture from entering.
7. If storing in a humid or salt-air atmosphere, coat all exposed metal surfaces with a light film of oil. Do not apply oil to any rubber parts or the seat cover.
8. Remove the battery and charge it. Store it in a dry place and recharge it once a month. Do not store the battery in an excessively warm or cold place (less than 0°C or more than 30°C).

EUU05800

NOTE: _____
Make any necessary repairs before storing the motorcycle.

SPECIFICATIONS

Model	XV750
Dimension: Overall length Overall width Overall height Seat height Wheel base Minimum ground clearance	2,285 mm 840 mm 1,190 mm 715 mm 1,525 mm 145 mm
Basic weight: With oil and full fuel tank	235 kg
Minimum turning radius	2,800 mm
Engine: Type Cylinder arrangement Displacement Bore × Stroke Compression ratio Starting system Lubrication system	Air cooled, 4-stroke, gasoline, SOHC V-2 cylinder 749 cm ³ 83.0 × 69.2 mm 8.7 : 1 Electric starter Wet sump

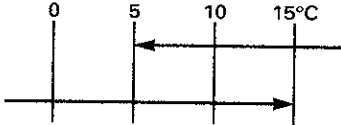
Model	XV750
<p>Engine oil (4-cycle) Type</p>  <p>Capacity Periodic oil change With oil filter replacement Total amount</p>	<p>SAE 20W40 type SE motor oil (If temperature does not go below 5°C) SAE 10W30 type SE motor oil (If temperature does not go above 15°C)</p> <p>3.0 L 3.1 L 3.6 L</p>
<p>Final gear oil: Type Capacity</p>	<p>SAE 80 API "GL-4" Hypoid gear oil 0.2 L</p>
<p>Air filter:</p>	<p>Dry type element</p>
<p>Fuel: Type Tank capacity Reserve amount</p>	<p>Regular gasoline For Australia: Unleaded fuel only 14.5 L 2.5 L</p>
<p>Carburetor: Type/manufacturer</p>	<p>BST40/MIKUNI</p>
<p>Spark plug. Type/manufacturer Gap</p>	<p>BPR7ES/NGK or W22EPR-U/NIPPONDENSO 0.7 ~ 0.8 mm</p>

Model	XV750
Clutch type:	Wet, multi-disc
Transmission Primary reduction system Primary reduction ratio Secondary reduction system Secondary reduction ratio Transmission type Operation Gear ratio 1st 2nd 3rd 4th 5th	Spur gear 78/47 (1.659) Shaft drive 47/45 × 19/18 × 32/11 (3.207) Constant mesh 5-speed Left foot operation 40/17 (2.352) 40/24 (1.666) 36/28 (1.285) 32/31 (1.032) 29/34 (0.852)
Chassis. Frame type Caster angle Trail	Pressed backbone 32° 129 mm
Tire: Type Size – Front Rear	Tubeless tire 100/90-19 57H 140/90-15 M/C 70H
Brake: Front brake type Operation Rear brake type Operation	Dual, Disc brake Right hand operation Drum brake Right foot operation

Model	XV750
Suspension: Front Rear	Telescopic fork Swingarm
Shock absorber: Front Rear	Coil spring, Oil damper Coil spring, Oil damper
Wheel travel: Front Rear	150 mm 97 mm
Electrical: Ignition system Generator system Battery type/capacity	TCI (Digital) AC magneto generator YB16AL/12V 16AH
Headlight type:	Quartz bulb
Bulb voltage, wattage × quantity: Headlight Tail/Brake light Flasher light Meter light Neutral indicator light High beam indicator light Oil level indicator light Turn indicator light Fuel indicator light	12V 60W/55W × 1 12V 5W/21W × 2 12V 21W × 4 12V 3W × 4 12V 3W × 1 12V 3W × 1 12V 3W × 1 12V 3W × 2 12V 3W × 1

HOW TO USE THE CONVERSION TABLE

All specification data in this manual are listed in SI and METRIC UNITS.

Use this table to convert METRIC unit data to IMPERIAL unit data.

Ex.

METRIC		MULTIPLIER	=	IMPERIAL
**mm	×	0.03937	=	**in
2 mm	×	0.03937	=	0.08 in

CONVERSION TABLE

METRIC TO IMPERIAL			
	Metric unit	Multiplier	Imperial unit
Torque	m kg	7 233	ft lb
	m kg	86 794	in lb
	cm kg	0 0723	ft lb
	cm kg	0 8679	in lb
Weight	kg	2 205	lb
	g	0 03527	oz
Speed	km/hr	0 6214	mph
Distance	km	0.6214	mi
	m	3.281	ft
	m	1 094	yd
	cm	0 3937	in
	mm	0 03937	in
Volume / Capacity	cc (cm ³)	0 03527	oz (IMP liq)
	cc (cm ³)	0.06102	cu in
	lt (liter)	0 8799	qt (IMP liq.)
	lt (liter)	0.2199	gal (IMP liq)
Misc	kg/mm	55.997	lb/in
	kg/cm ²	14.2234	psi (lb/in ²)
	Centigrade (°C)	9/5 + 32	Fahrenheit (°F)

NOISE REGULATION (FOR Australia)

“TAMPERING WITH NOISE CONTROL SYSTEM PROHIBITED”

Owners are warned that the law may prohibit:

- (a) The removal or rendering inoperative by any person other than for purposes of maintenance, repair or replacement, of any device or element of design incorporated into any new vehicle for the purpose of noise control prior to its sale or delivery to the ultimate purchaser or while it is in use; and
- (b) the use of the vehicle after such device or element of design has been removed or rendered inoperative by any person.

PRINTED ON RECYCLED PAPER

YAMAHA
YAMAHA MOTOR CO., LTD

PRINTED IN JAPAN
95 9-03×1 CR
(英)

WIRING DIAGRAM XV750

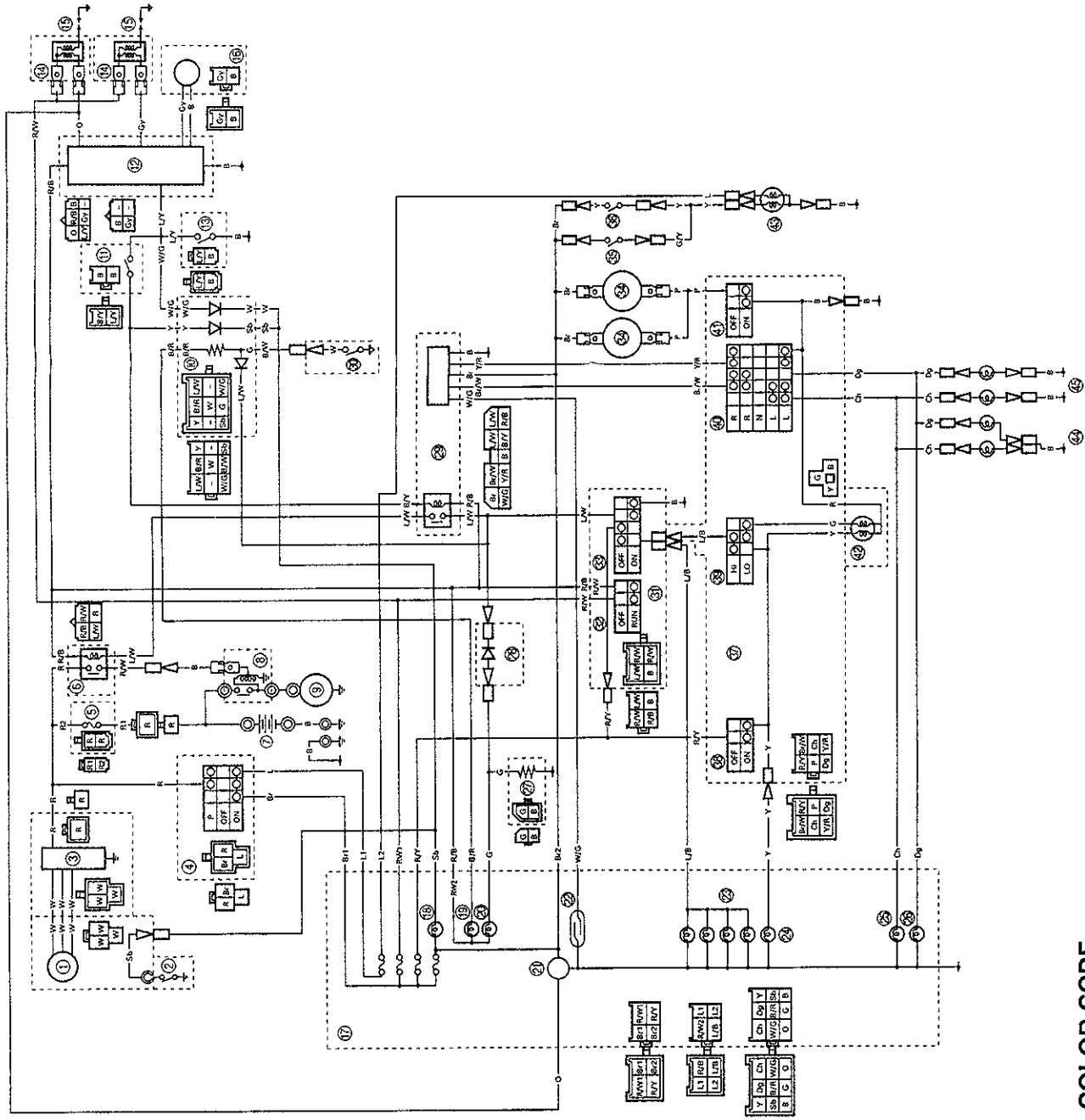

- 1 A.C magneto
- 2 Neutral switch
- 3 Rectifier/regulator
- 4 Main switch
- 5 Fuse (Main)
- 6 Starter relay
- 7 Battery
- 8 Solenoid
- 9 Starter motor
- 10 Diode assembly
- 11 Clutch switch
- 12 Igniter unit
- 13 Sidestand switch
- 14 Ignition coil
- 15 Spark plug
- 16 Pick-up coil
- 17 Meter assembly
- 18 Neutral indicator light
- 19 Oil level indicator light
- 20 Fuel level indicator light
- 21 Tachometer
- 22 Reed switch
- 23 Meter light
- 24 High beam indicator light
- 25 Turn indicator light (Left)
- 26 Turn indicator light (Right)
- 27 Fuel sender
- 28 Diode
- 29 Flasher relay
- 30 Oil level gauge
- 31 Handlebar switch (Right)
- 32 Engine stop switch
- 33 Start switch
- 34 Horn
- 35 Front brake switch
- 36 Rear brake switch
- 37 Handlebar switch (Left)
- 38 Pass switch
- 39 Dimmer switch
- 40 Turn signal switch
- 41 Horn switch
- 42 Headlight
- 43 Tail/brake light
- 44 Front flasher light
- 45 Rear flasher light

COLOR CODE

B	Black	P	Pink	W	White	L/W	Blue/White	Br/W	Brown/White
L	Blue	Br	Brown	B/Y	Black/Yellow	G/Y	Green/Yellow	W/G	White/Green
G	Green	Ch	Chocolate	B/R	Black/Red	Y/R	Yellow/Red		
Y	Yellow	Gy	Gray	B/W	Black/White	R/B	Red/Black		
R	Red	Sb	Sky blue	L/B	Blue/Black	R/Y	Red/Yellow		
O	Orange	Dg	Dark green	L/Y	Blue/Yellow	R/W	Red/White		