

YAMAHA

OWNER'S MANUAL

YZF750RF

4HA-28199-21

YZF750RF

OWNER'S MANUAL

©1993 by Yamaha Motor Co., Ltd.

1st Edition, September 1993

**All rights reserved. Any reprinting or
unauthorized use without the written
permission of Yamaha Motor Co., Ltd.
is expressly prohibited.**

Printed in Japan

INTRODUCTION

Congratulations on your purchase of the Yamaha YZF750RF. This model is the result of Yamaha's vast experience in the production of fine sporting, touring, and pacesetting racing machines. It represents the high degree of craftsmanship and reliability that have made Yamaha a leader in these fields.

This manual will give you an understanding of the operation, inspection, and basic maintenance of this motorcycle. If you have any questions about the operation or maintenance of your motorcycle, please consult a Yamaha dealer.

Particularly important information is distinguished in this manual by the following notations:



The Safety Alert Symbol means ATTENTION! BECOME ALERT! YOUR SAFETY IS INVOLVED!

! WARNING

Failure to follow **WARNING** instructions could result in severe injury or death to the motorcycle operator, a bystander or a person inspecting or repairing the motorcycle.

CAUTION:

A **CAUTION** indicates special precautions that must be taken to avoid damage to the motorcycle.

NOTE:

A **NOTE** provides key information to make procedures easier or clearer.

NOTE:

This manual should be considered a permanent part of this motorcycle and should remain with it even if the motorcycle is subsequently sold.

NOTE:

Yamaha continually seeks advancements in product design and quality. Therefore, while this manual contains the most current product information available at the time of printing, there may be minor discrepancies between your machine and this manual. If there is any question concerning this manual, please consult your Yamaha dealer.

! WARNING

PLEASE READ THIS MANUAL CAREFULLY AND COMPLETELY BEFORE OPERATING THIS MOTORCYCLE.

CONTENTS

SAFETY INFORMATION	1-1	Fuel tank cap.	5-14
LOCATION OF THE IMPORTANT LABELS.....	2-1	Starter lever (CHOKE)	5-15
DESCRIPTION	3-1	Steering lock	5-16
MOTORCYCLE IDENTIFICATION	4-1	Seat.....	5-17
Identification numbers record	4-2	Helmet holder.....	5-19
Vehicle identification number	4-3	Lower cowl removal	5-19
Engine serial number	4-3	Side cowl removal.	5-20
CONTROL FUNCTIONS	5-1	Front fork and rear shock absorber	5-21
Main switch	5-2	EXUP	
Indicator lights	5-3	(Exhaust ultimate power valve).....	5-22
Oil level indicator circuit check.....	5-5	Sidestand	5-23
Fuel level indicator circuit check	5-7	Sidestand/clutch switch operation	
Speedometer.....	5-8	check.....	5-24
Tachometer	5-8	PRE-OPERATION CHECKS.....	6-1
Engine temperature gauge.....	5-9	Brakes	6-4
Handlebar switches	5-10	Brake/Clutch fluid leakage	6-5
Clutch lever.....	5-12	Throttle grip	6-5
Shift pedal	5-13	Engine oil	6-6
Front brake lever.....	5-13	Coolant	6-6
Rear brake pedal	5-14	Chain	6-7
		Tires	6-8
		Tubeless tires and cast wheels	6-12
		Fittings/Fasteners.	6-13

Lights and signals.....	6-14
Switches	6-14
Fuel.....	6-15

OPERATION AND IMPORTANT

RIDING POINTS.....	7-1
Starting and warming up	
a cold engine	7-2
Starting a warm engine	7-5
Shifting	7-6
Engine break-in	7-6
Parking	7-8

PERIODIC MAINTENANCE AND

MINOR REPAIR.....	8-1
Tool kit	8-3
Periodic maintenance / Lubrication ...	8-4
Torque specifications	8-7
Engine oil.....	8-8
Cooling system	8-13
Electric fan	8-16
Air filter	8-17
Carburetor adjustment.....	8-19
Idle speed adjustment.....	8-20

Throttle cable adjustment	8-21
Valve clearance adjustment.....	8-22
Spark plug inspection	8-22
Front brake lever position	
adjustment.....	8-24
Rear brake adjustment.....	8-24
Brake light switch adjustment	8-25
Checking the front and	
rear brake pads	8-26
Inspecting the brake fluid level.....	8-27
Brake fluid replacement.....	8-28
Clutch lever position adjustment.....	8-29
Clutch adjustment	8-29
Drive chain slack check.....	8-30
Drive chain slack adjustment	8-30
Drive chain lubrication.....	8-32
Cable inspection and lubrication	8-32
Throttle cable and grip lubrication...	8-33
Brake and shift pedals	8-33
Brake and clutch levers.....	8-34
Sidestand	8-34
Rear suspension	8-35
Front fork inspection	8-35
Front fork adjustment	8-36

Rear shock absorber.....	8-38
Rear shock absorber adjustment....	8-39
Recommended combinations of the front fork and the rear shock absorber settings.....	8-41
Steering inspection.....	8-42
Wheel bearings.....	8-42
Battery.....	8-43
Battery maintenance.....	8-44
Fuse replacement.....	8-44
Headlight bulb replacement.....	8-45
Front wheel removal.....	8-47
Front wheel installation.....	8-48
Rear wheel removal.....	8-50
Rear wheel installation.....	8-52
Troubleshooting.....	8-52
Troubleshooting chart.....	8-53

CLEANING AND STORAGE.....	9-1
A. Cleaning.....	9-2
B. Storage.....	9-4

SPECIFICATIONS.....	10-1
---------------------	------

NOISE REGULATION.....	11-1
-----------------------	------

WIRING DIAGRAM

⚠ SAFETY INFORMATION

TWO-WHEELED MOTORCYCLES ARE SINGLE TRACK VEHICLES. THEIR SAFE USE AND OPERATION ARE DEPENDENT UPON THE USE OF PROPER RIDING TECHNIQUES AS WELL AS THE EXPERTISE OF THE OPERATOR. EVERY OPERATOR SHOULD KNOW THE FOLLOWING REQUIREMENTS BEFORE RIDING.

HE OR SHE SHOULD:

- 1. OBTAIN THOROUGH INSTRUCTIONS FROM A COMPETENT SOURCE ON ALL ASPECTS OF MOTORCYCLE OPERATION.**
- 2. OBSERVE THE WARNINGS AND MAINTENANCE REQUIREMENTS IN THE OWNER'S MANUAL.**
- 3. OBTAIN QUALIFIED TRAINING IN SAFE AND PROPER RIDING TECHNIQUES.**
- 4. OBTAIN PROFESSIONAL TECHNICAL SERVICE AS INDICATED BY THE OWNER'S MANUAL AND/OR WHEN MADE NECESSARY BY MECHANICAL CONDITIONS.**

SAFE RIDING

- 1. Always make pre-operation checks. Careful checks may help prevent an accident.**
- 2. This motorcycle is designed to carry the operator and a passenger.**
- 3. The failure of motorists to detect and recognize motorcycles in traffic is the predominant cause of automobile/motorcycle accidents. Many accidents have been caused by an automobile driver who did not see the motorcycle. Making yourself conspicuous appears to be very effective in reducing the chance of this type of accident.**

Therefore:

- a. **Wear a brightly colored jacket.**
 - b. **Use extra caution when you approach and pass through intersections, since intersections are the most likely places for motorcycle accidents.**
 - c. **Ride where other motorists can see you. Avoid riding in another motorist's "blind spot".**
- 4. Many accidents involve inexperienced operators. In fact, many operators who have been involved in accidents do not even have a current motorcycle license.**
- a. **Make sure you are qualified. Also, only lend your motorcycle to experienced operators.**
 - b. **Know your skills and limits. Staying within your limits may help you to avoid an accident.**
 - c. **We recommend that you practice riding your motorcycle where there is no traffic until you have become thoroughly familiar with your motorcycle and all of its controls.**
- 5. Many motorcycle accidents have been caused by motorcycle operator errors. A typical error made by the operator is veering wide on a turn due to EXCESSIVE SPEED or undercornering (insufficient lean angle for the speed).**
- a. **Always obey the speed limits and never travel faster than warranted by road and traffic conditions.**
 - b. **Always signal before turning or changing lanes. Make sure other motorists see you.**

6. The operator's and passenger's posture are important for proper control.
 - a. The operator should keep both hands on the handlebars and both feet on the operator footrests during operation to maintain control of the motorcycle.
 - b. The passenger should always hold on to the operator, or the seat strap or grab bar if the motorcycle is so equipped, with both hands and keep both feet on the passenger footrests.
 - c. Never carry a passenger unless he or she can firmly place both feet on the passenger footrests.
7. Never ride under the influence of alcohol or drugs.
8. This motorcycle is designed for on-road use only. It is not suitable for off-road use.

PROTECTIVE APPAREL

The majority of fatalities from motorcycle accidents are the result of head injuries. The use of a safety helmet is the single most critical factor in the prevention or reduction of head injuries.

1. Always wear an approved helmet.
2. Wear a face shield or goggles. Wind on your unprotected eyes could contribute to an impairment of vision which could delay seeing a hazard.
3. The use of heavy boots, jacket, trousers, gloves, etc. is effective in preventing or reducing abrasions or lacerations.

4. Never wear loose fitting clothing. It could catch on the control levers, footrests, or wheels and cause injury or accident.
5. Never touch the engine or exhaust system during or after operation. They become very hot and can cause burns. Always wear protective clothing that covers your legs, ankles, and feet.
6. A passenger should also observe the above precautions.

MODIFICATION

Modifications made to the motorcycle not approved by Yamaha, or the removal of original equipment, may render your motorcycle unsafe for use and may cause severe personal injury. Modifications may also make your motorcycle illegal to use.

LOADING AND ACCESSORIES

Adding accessories or cargo to your motorcycle can adversely affect stability and handling if the weight distribution of the machine is changed. To avoid the possibility of an accident, extreme caution should be used if adding cargo or accessories to your motorcycle. Use extra care if riding a motorcycle which has added cargo or accessories. Here are some general guidelines to follow if loading cargo or adding accessories to your motorcycle:

LOADING

The total weight of the operator, passenger, accessories and cargo must not exceed the maximum load limit of 379 lbs. (172 kg).

When loading within these weight limits, keep the following in mind:

1. Cargo and accessory weight should be kept as low and close to the motorcycle as possible. Be sure to distribute the weight as evenly as possible on both sides of the machine to minimize imbalance or instability.
2. Shifting weights can create a sudden imbalance. Make sure that accessories and cargo are securely attached to the motorcycle before riding. Recheck accessory mounts and cargo restraints frequently.
3. Never attach any large or heavy items to the handlebars, front forks, or front fender. These items, including such cargo as sleeping bags, duffle bags, or tents, can create unstable handling or slow steering response.

ACCESSORIES

Genuine Yamaha accessories have been specifically designed for use on this motorcycle. Since Yamaha cannot test all other accessories which may be available, you must personally be responsible for the proper selection, installation and use of non-Yamaha accessories. You should use extreme caution when selecting and installing any accessories.

Keep in mind these guidelines for mounting accessories in addition to those provided under "LOADING".

- 1. Never install accessories or carry cargo that would impair the performance of your motorcycle. Carefully inspect the accessory before using it to make sure it does not in any way reduce ground clearance or cornering clearance, limit suspension travel, steering travel or control operation, or obscure lights or reflectors.**
 - a. Accessories fitted to the handlebar or the front fork area can create instability due to improper weight distribution or aerodynamic changes. If accessories are added to the handlebar or front fork area, they must be as lightweight as possible and should be kept to a minimum.**
 - b. Bulky or large accessories may seriously affect the stability of the motorcycle due to aerodynamic effects. Wind may attempt to lift the motorcycle, or the motorcycle may become unstable in cross winds. These accessories may also cause instability when being passed by or passing large vehicle.**
 - c. Certain accessories can displace the operator from his or her normal riding position. This improper position limits the freedom of movement of the operator and may limit control ability. Therefore such accessories are not recommended.**
- 2. Caution must be used if adding electrical accessories. If these accessories exceed the capacity of the motorcycle's electrical system, an electric failure could result, which could cause a dangerous loss of lights or engine power.**

GASOLINE AND EXHAUST GAS

- 1. GASOLINE IS HIGHLY FLAMMABLE:**
 - a. Always turn off the engine when refueling.**
 - b. Take care not to spill any gasoline on the engine or exhaust pipe(s)/muffler(s) when refueling.**
 - c. Never refuel while smoking or in the vicinity of an open flame.**
- 2. Never start the engine or let it run for any length of time in a closed area. The exhaust fumes are poisonous and may cause loss of consciousness and death within a short time. Always operate your motorcycle in an area that has adequate ventilation.**
- 3. Always turn off the engine before leaving the motorcycle unattended and remove the ignition key. When parking the motorcycle, note the following:**
 - a. The engine and exhaust pipe(s)/muffler(s) may be hot. Park the motorcycle in a place where pedestrians or children are not likely to touch these hot areas.**
 - b. Do not park the motorcycle on a slope or soft ground; the motorcycle may fall over.**
 - c. Do not park the motorcycle near a flammable source, e.g. a kerosene heater, or near an open flame. The motorcycle could catch fire.**
- 4. When transporting the motorcycle in another vehicle, be sure it is kept upright and that the fuel cock(s) is turned to "ON" or "RES" (for vacuum type)/"OFF" (for manual type). If it should lean over, gasoline may leak out of the carburetor or fuel tank.**
- 5. If you should swallow any gasoline, inhale a lot of gasoline vapor, or allow gasoline to get in your eye(s), see your doctor immediately. If any gasoline spills on your skin or clothing, immediately wash it off with soap and water and change your clothes.**

LOCATION OF THE IMPORTANT LABELS

Please read the following labels carefully before operating this motorcycle.

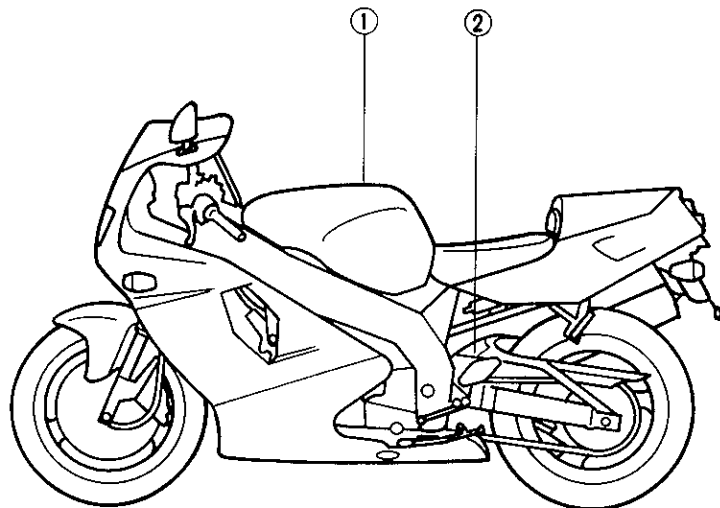

①

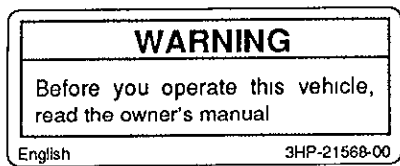

②



DESCRIPTION

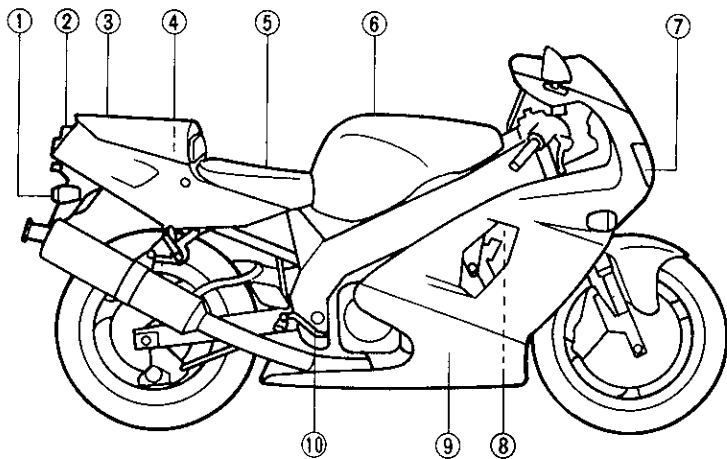

- 1. Rear flasher light
- 2. Tail/brake light
- 3. Passenger seat cover (Page 5-17)
- 4. Passenger seat (Page 5-17)
- 5. Seat (Page 5-18)
- 6. Fuel tank (Page 5-14)
- 7. Dual headlight
- 8. Radiator (Page 8-14)
- 9. Lower cowl (Page 5-19)
- 10. Brake pedal (Page 5-14)

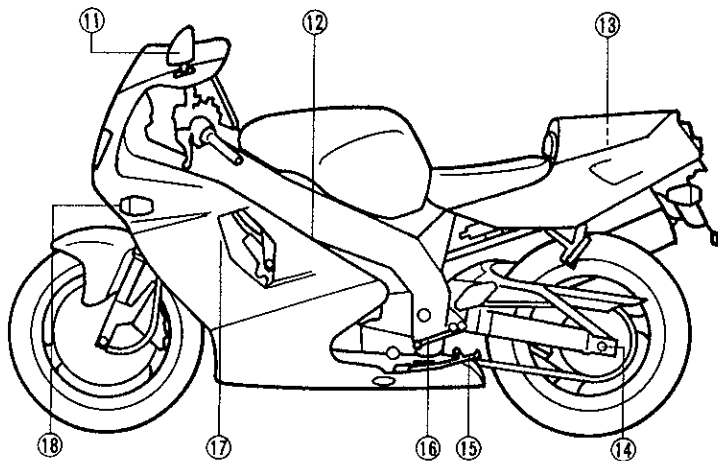

- 11. Rear view mirror
- 12. Starter lever (CHOKE) (Page 5-15)
- 13. Tool kit (Page 8-3)
- 14. Chain puller
- 15. Sidestand (Page 5-23)
- 16. Shift pedal (Page 5-13)
- 17. Side cowl (Page 5-20)
- 18. Front flasher light

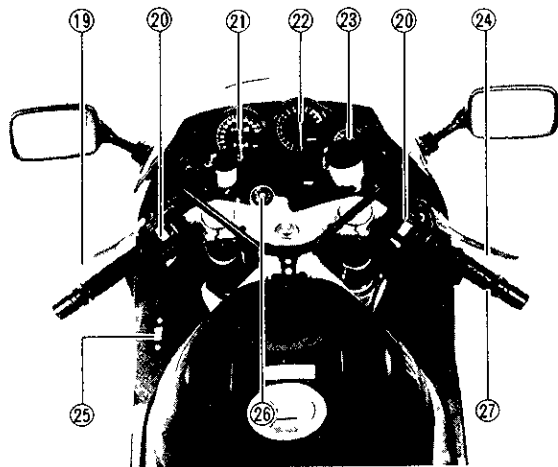

- | | |
|------------------------------|-------------|
| 19. Clutch lever | (Page 5-12) |
| 20. Handlebar switches | (Page 5-10) |
| 21. Speedometer | (Page 5-8) |
| 22. Tachometer | (Page 5-8) |
| 23. Engine temperature gauge | (Page 5-9) |
| 24. Brake lever | (Page 5-13) |
| 25. Fuel (Reserve) switch | (Page 5-12) |
| 26. Main switch | (Page 5-2) |
| 27. Throttle grip | (Page 8-21) |

MOTORCYCLE IDENTIFICATION

Identification numbers record

1. KEY IDENTIFICATION NUMBER:

2 VEHICLE IDENTIFICATION NUMBER:

3 ENGINE SERIAL NUMBER:

Your key identification number is stamped on your key as shown in the following illustration

Record this number in the space provided for reference if you need a new key.

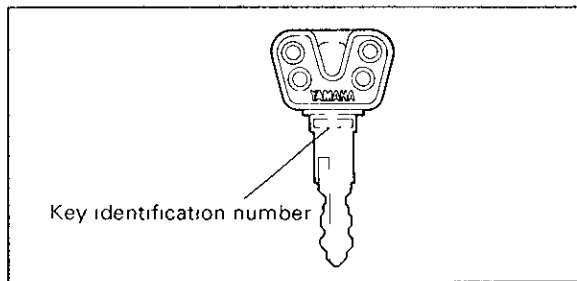

Record your vehicle identification number and engine serial number in the spaces provided to assist you in ordering spare parts from your Yamaha dealer or for reference in case your vehicle is stolen.

Vehicle identification number

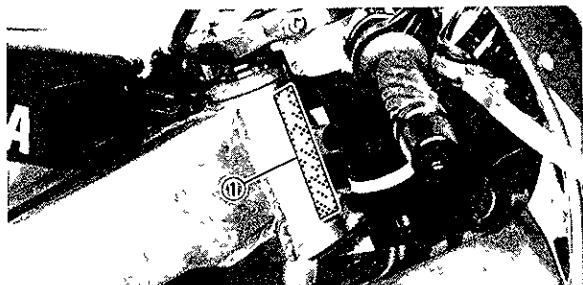

1 Vehicle identification number

The vehicle identification number is stamped into the steering head pipe.

NOTE: _____

The vehicle identification number is used to identify your motorcycle and may be used to register your motorcycle with the licensing authority in your state.

Engine serial number

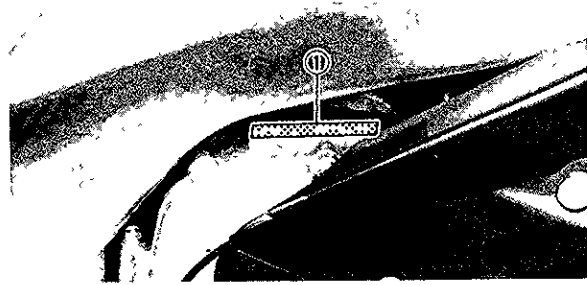

1 Engine serial number

The engine serial number is stamped into the crankcase.

NOTE: _____

The first three digits of these numbers are for model identification; the remaining digits are the unit production number. Keep a record of these numbers for reference when ordering parts from a Yamaha dealer.

CONTROL FUNCTIONS

Main switch

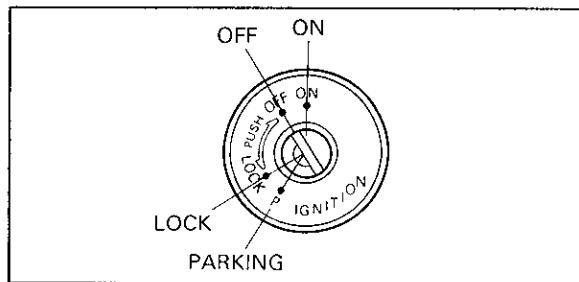

The main switch controls the ignition and lighting systems. Its operation is described below.

ON:
Electrical circuits are switched on, and the headlight, meter light, taillight and license light come on. The engine can be started. The key cannot be removed in this position.

OFF:
All electrical circuits are switched off. The key can be removed in this position.

LOCK:
The steering is locked in this position, and all electrical circuits are switched off. The key can be removed in this position. Refer to "Steering lock" (page 5-16) for operation instructions.

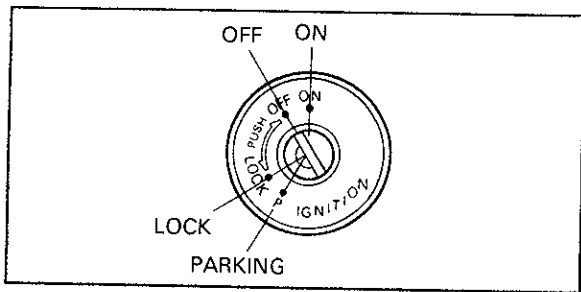

PARKING:

The steering is locked in this position, and the taillight and license light come on but all other circuits are off. The key can be removed in this position.

NOTE:

Always turn the main switch to "OFF" or "LOCK" and remove the key when the motorcycle is unattended.

Indicator lights

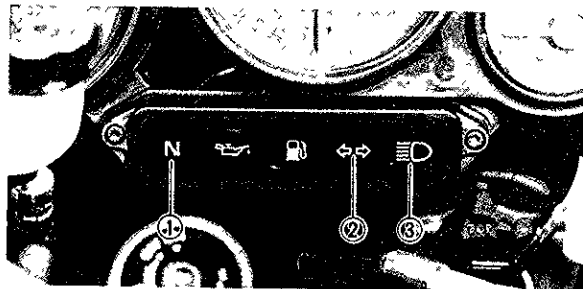

1. "NEUTRAL" indicator light
2. "TURN" indicator light
3. "HIGH BEAM" indicator light

[N] "NEUTRAL" indicator light (green):
This indicator comes on when the transmission is in neutral.

[↔] "TURN" indicator light (green):
This indicator flashes when the turn switch is "ON".

[D] "HIGH BEAM" indicator light (blue):
This indicator comes on when the headlight high beam is used.

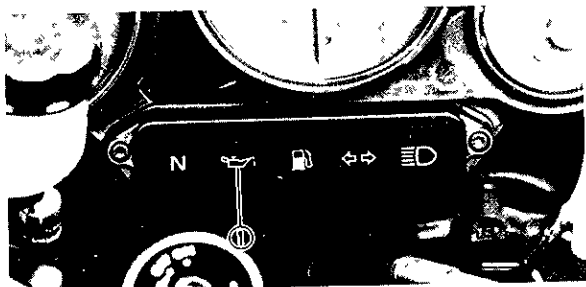

1 "OIL LEVEL" indicator light

 "OIL LEVEL" indicator light (red):

This indicator comes on when the oil level is low. This light circuit can be checked by the following procedure.

CAUTION: _____

Do not run the motorcycle until you know it has sufficient engine oil.

Oil level indicator circuit check

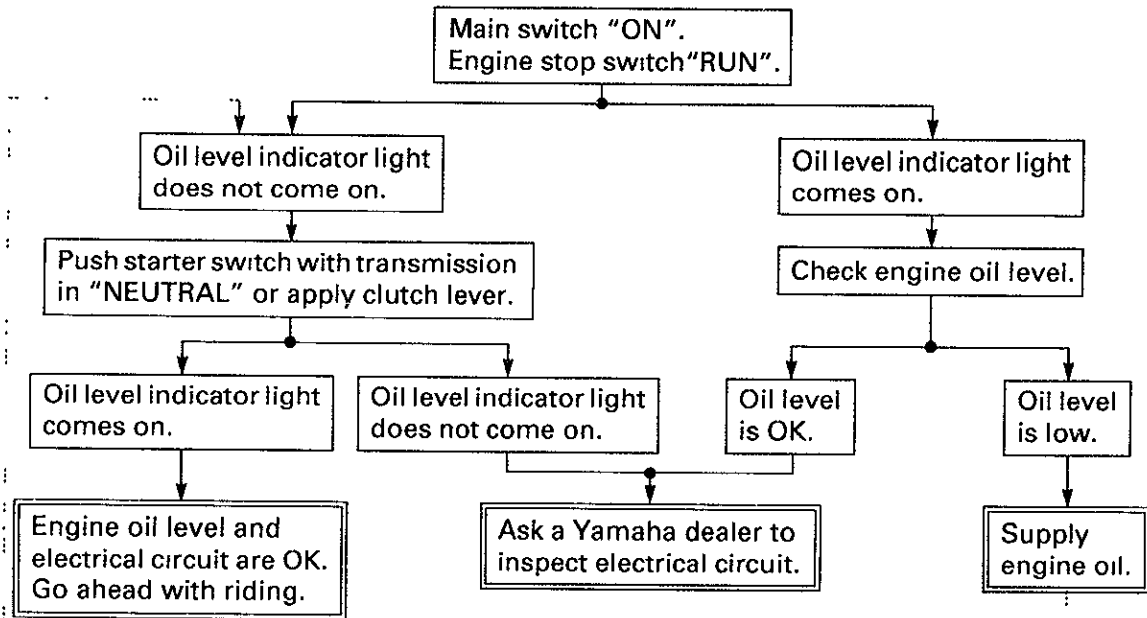

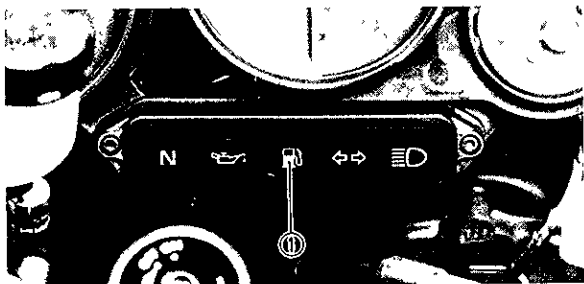

1 "FUEL LEVEL" indicator light

 "FUEL LEVEL" indicator light (red):
When the fuel level drops below approximately 3.5 L (0.8 Imp gal, 0.9 US gal), this light will come on. When this light comes on, move the "FUEL" (Reserve) switch to "RES". Then, fill the tank at the first opportunity.

Fuel level indicator circuit check

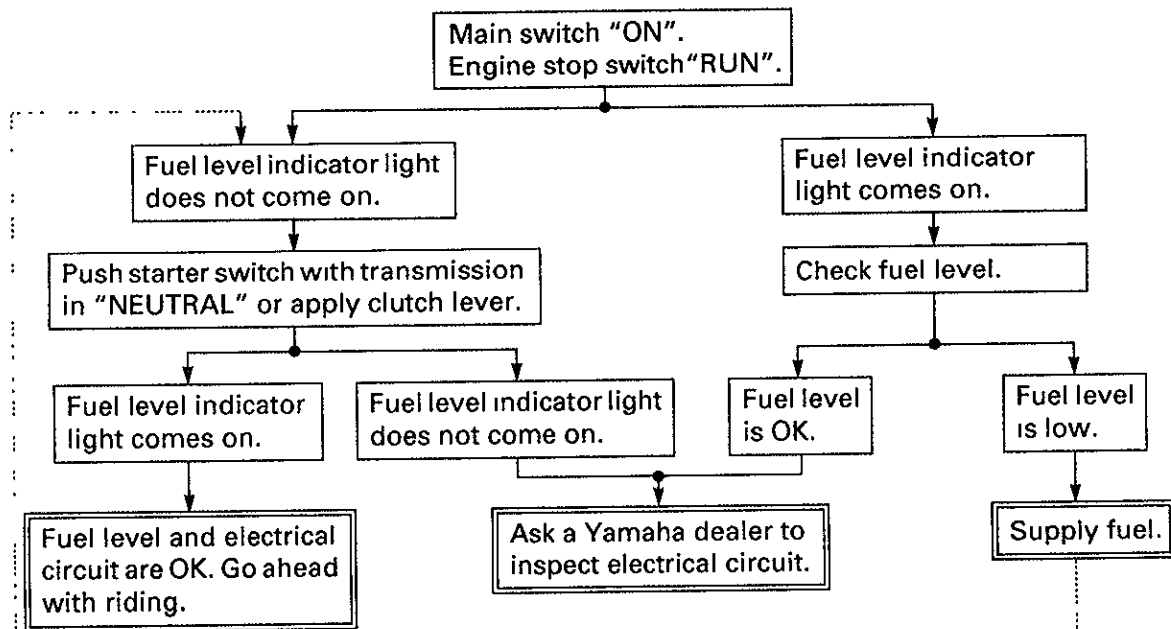

Speedometer

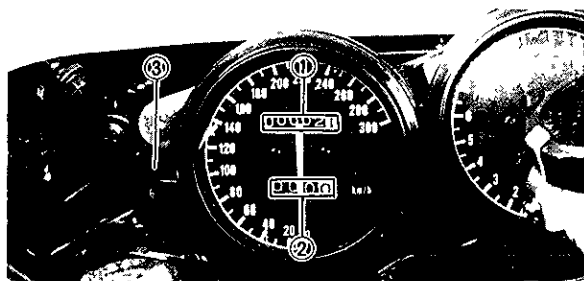

1 Odometer 2 Trip odometer 3. Reset knob

The speedometer shows riding speed. This speedometer is equipped with an odometer and trip odometer. The trip odometer can be reset to "0" with the reset knob. Use the odometer to estimate how far you can ride on a tank of fuel before going to "RESERVE". This information will enable you to plan fuel stops in the future.

Tachometer

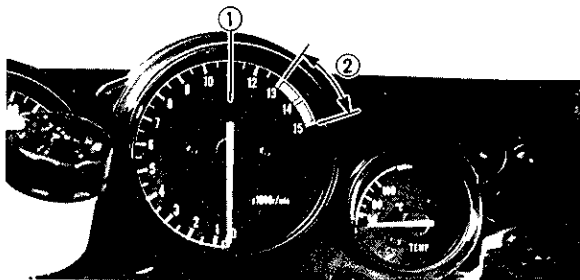

1 Tachometer 2 Red zone

This model is equipped with an electric tachometer so the rider can monitor the engine speed and keep it within the ideal power range.

CAUTION:

Do not operate in the red zone
Red zone: 13,000 r/min and above

Engine temperature gauge

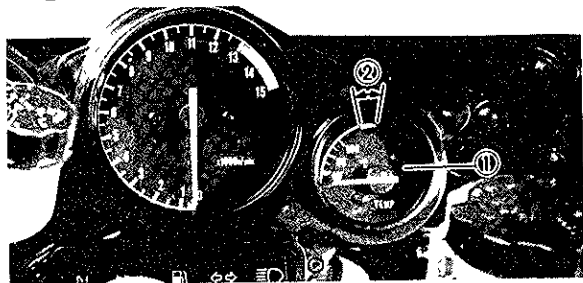

1. Engine temperature gauge

2. Red zone

This gauge indicates the coolant temperature when the main switch is ON. The engine operating temperature will vary with changes in weather and engine load. If the needle points to the red zone or higher, stop your motorcycle and let the engine cool. (See page 8-13 for details.)

CAUTION:

When the engine is overheated, do not continue riding.

Handlebar switches:

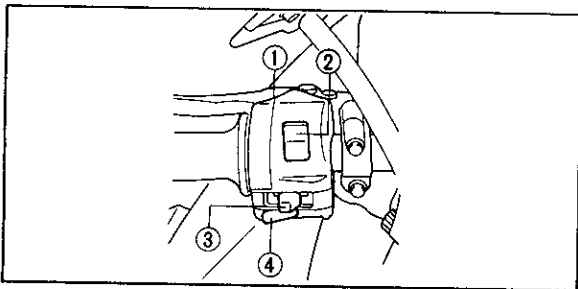

1. "PASS" switch

2 "LIGHTS"(Dimmer) switch

3 "TURN" signal switch

4 "HORN" switch

"PASS" switch

Press the switch to operate the passing light.

"LIGHTS" (Dimmer) switch

Turn the switch to "HI" for the high beam and to "LO" for the low beam.

"TURN" signal switch

To signal a right-hand turn, push the switch to the right; to signal a left-hand turn, push the switch to the left. Once the switch is released, it will return to the center position. To cancel the signal, push the switch in after it has returned to the center position.

"HORN" switch

Press the switch to sound the horn.

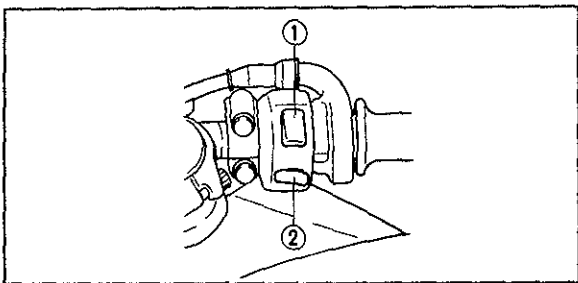

1 "ENGINE STOP" switch 2 "START" switch

"ENGINE STOP" switch

The engine stop switch is a safety device for use in an emergency such as when the motorcycle overturns or if trouble occurs in the throttle system. Turn the switch to "RUN" to start the engine. In case of emergency, turn the switch to "OFF" to stop the engine.

"START" switch

The starter motor cranks the engine when pushing the starter switch.

CAUTION:

See starting instructions prior to starting the engine.

"FUEL" (Reserve) switch

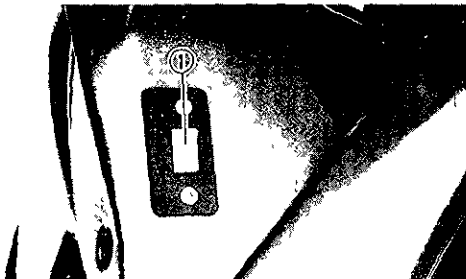

1 "FUEL"(Reserve) switch

This switch should usually be kept on while riding. When the "FUEL LEVEL" indicator light comes on during a run, move the switch to "RES" and refuel at the first opportunity. Then move the switch to "ON".

NOTE:

When the switch is turned to "RES", about 3.5 L (0.8 Imp gal, 0.9 US gal) remain in the fuel tank.

Clutch lever

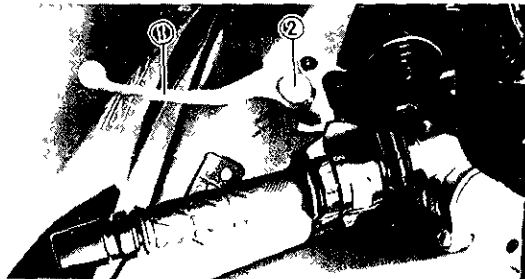

1 Clutch lever

2 Position adjuster

This model is equipped with a hydraulic clutch and lever position adjuster. (Refer to page 8-29 for lever adjustment procedure.) The clutch lever is located on the left handlebar and a starting circuit cut-off switch is incorporated in the clutch lever holder. Pull the clutch lever toward the handlebar to disengage the clutch, and release the lever to engage the clutch. The lever should be pulled rapidly and released slowly for smooth clutch operation. (Refer to the engine starting procedures for a description of the starting circuit cut-off switch.)

Shift pedal

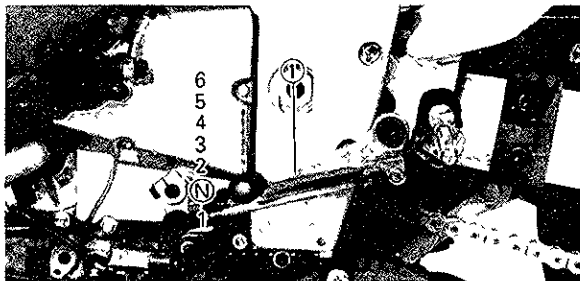

1 Shift pedal

N Neutral

This motorcycle is equipped with a constant-mesh 6-speed transmission. The shift pedal is located on the left side of the engine and is used in combination with the clutch when shifting.

Front brake lever

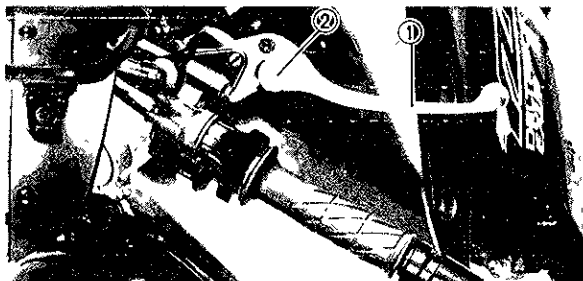

1. Front brake lever

2 Position adjuster

The front brake lever is located on the right handlebar. Pull it toward the handlebar to activate the front brake. The front brake lever is equipped with a lever position adjuster. Refer to page 8-24 for adjustment.

Rear brake pedal

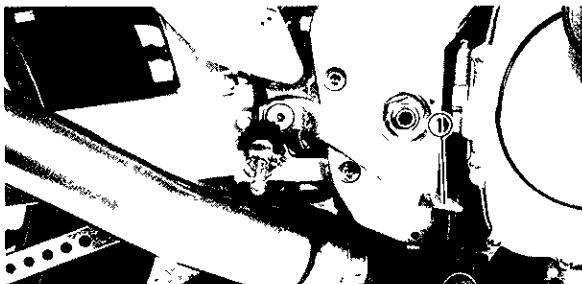

1 Rear brake pedal

The rear brake pedal is on the right side of the motorcycle. Press down on the brake pedal to apply the rear brake.

Fuel tank cap

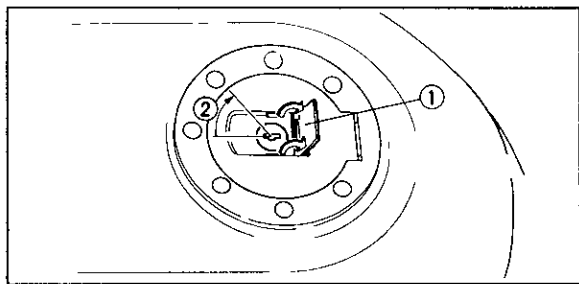

1 Key cover

2 Open

TO OPEN:

Open the key cover. Insert the key and turn it 1/4 turn clockwise. The lock will be released and the cap can be opened.

TO CLOSE:

Push the tank cap into position with the key inserted. To remove the key, turn it counterclockwise to the original position. Then, close the key cover.

NOTE:

This tank cap cannot be closed unless the key is in the lock. The key cannot be removed if the cap is not locked properly.

⚠ WARNING

Be sure the cap is properly installed and locked in place before riding the motorcycle.

Starter lever (CHOKE)

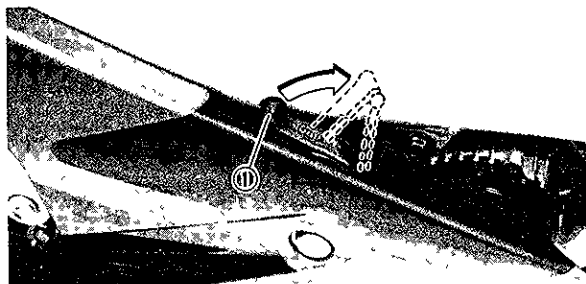

1. Starter lever (CHOKE)

Starting a cold engine requires a richer air-fuel mixture for starting. A separate starter circuit supplies this mixture. Pull the starter lever up to open the circuit for starting. When the engine has warmed up, push the lever down to close the circuit.

Steering lock

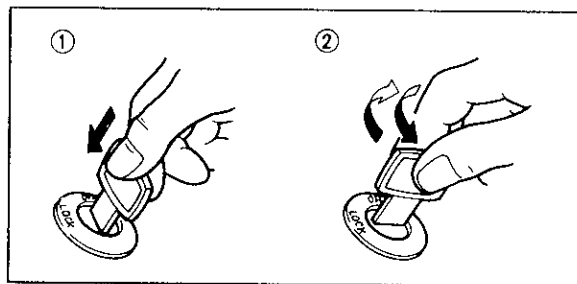
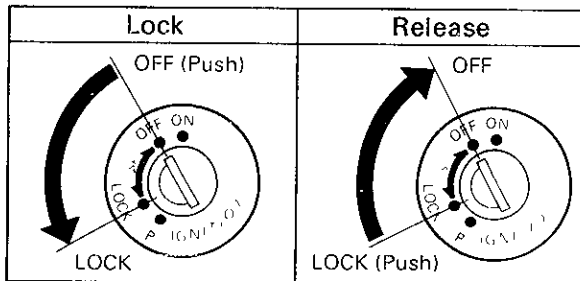

1 Push

2 Turn

The steering is locked when the main switch is turned to "LOCK". To lock the steering, turn the handlebars all the way to the left. While pushing the key into the main switch, turn it from "OFF" to "LOCK" and remove it. To release the lock, turn the key to "OFF" while pushing.

⚠ WARNING

Never turn the key to "LOCK" when the motorcycle is moving.

Seat

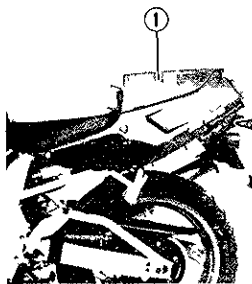

1 Passenger seat

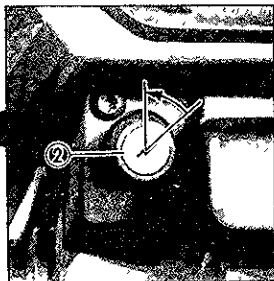

2 Seat lock

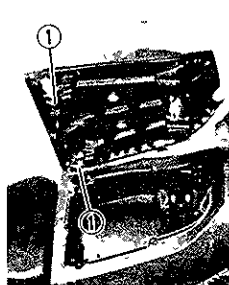

1 Holders

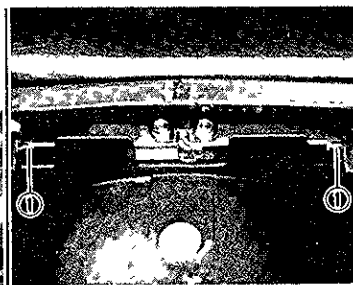

1. Pegs

1. Passenger seat

To remove the seat, insert the key in the lock and turn it counterclockwise.

When reinstalling the seat, hook the holders on the front of the seat under the pegs and push down on the seat.

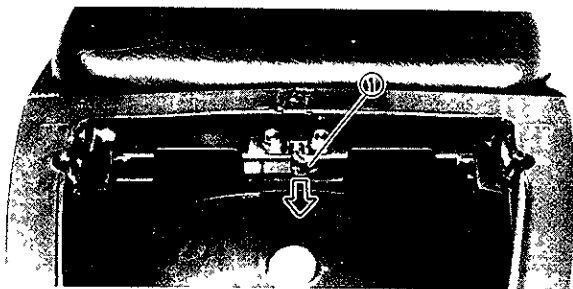

1 Lever

2. Rider seat

- a. Remove the passenger seat and pull the lever to release the rider seat.

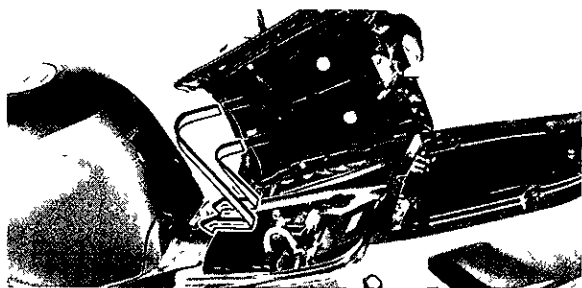

- b. When reinstalling the rider seat, insert the lobe(s) on the front of the seat into the receptacle on the frame, then push down on the seat to secure.
- c. Reinstall the passenger seat.

NOTE: _____

Make sure that the seat is securely fitted.

Helmet holder

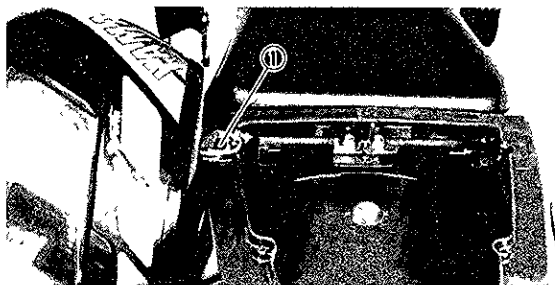

1. Helmet holder

The helmet holder is under the seat. Open the seat and hook the helmet on the helmet holder and then lock the seat.

WARNING

Never ride with a helmet in the helmet holder. The helmet may hit objects, causing loss of control and possibly an accident.

Lower cowl removal

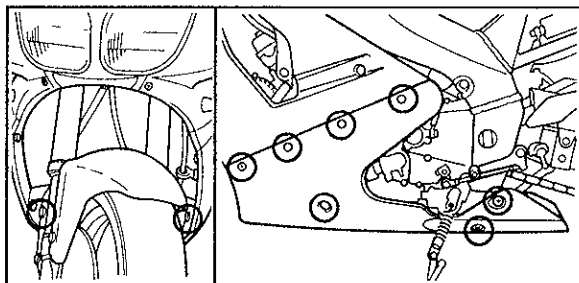

To remove the lower cowl, remove the bolts as shown.

Side cowl removal

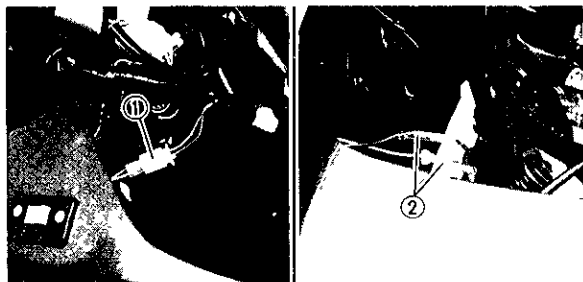

1 "FUEL"(Reserve) switch leads 2 Flasher light leads

1. Remove the lower cowl.
2. Disconnect the "FUEL" (Reserve) switch leads and the front flasher light leads.
3. Remove the speedometer cable from the front wheel side.

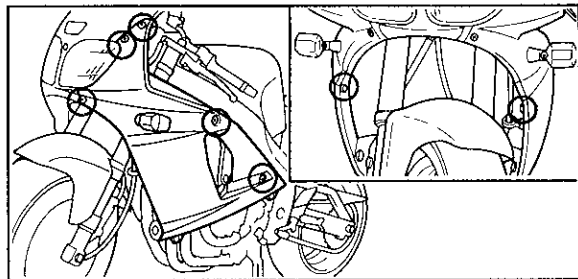

4. Remove the bolts as shown.

Front fork and rear shock absorber

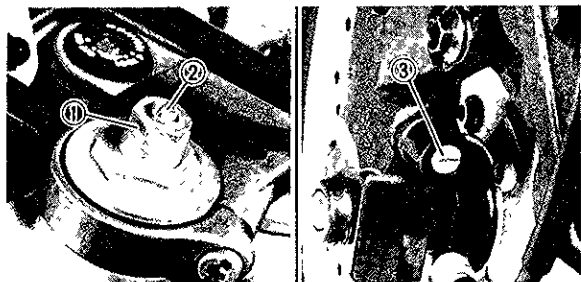

- 1 Spring preload adjuster
- 2 Rebound damping force adjuster
- 3 Compression damping force adjuster

The spring preload and the damping force of the front fork and rear shock absorber can be adjusted to suit the rider's preference, motorcycle's load (ex: optional accessories, etc.) and road conditions. Refer to page 8-36 for proper adjustment procedures.



- 1 Spring preload adjuster

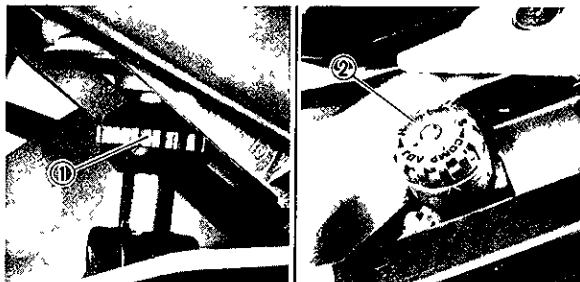

- 1 Rebound damping force adjuster
- 2 Compression damping force adjuster

EXUP (Exhaust ultimate power valve)

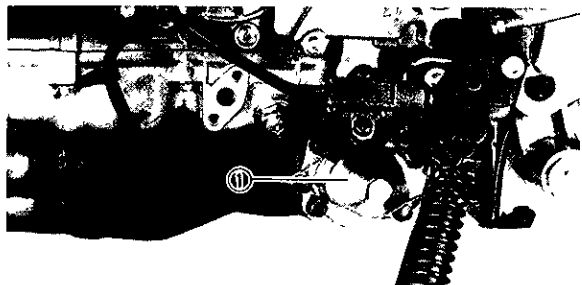

- 1 EXUP

This model is equipped with an EXUP system within the exhaust pipe. This valve is always activated by a computer-controlled servomotor in accordance with engine rpm.

CAUTION:

The EXUP was set at the Yamaha factory after many tests. If the settings are changed by someone without sufficient technical knowledge, poor engine performance and damage may result.

CAUTION:

If the EXUP does not operate, ask a Yamaha dealer to inspect.

Sidestand

This model is equipped with an ignition circuit cut-off system. The motorcycle must not be ridden when the sidestand is down. The sidestand is located on the left side of the frame. (Refer to page 7-2 for an explanation of this system.)

⚠ WARNING

This motorcycle must not be operated with the sidestand in the down position. If the stand is not properly retracted, it could contact the ground and distract the operator, resulting in a possible loss of control. Yamaha has designed into this motorcycle a lockout system to assist the operator in fulfilling the responsibility of retracting the sidestand. Please check carefully the operating instructions listed below and if there is any indication of a malfunction, return the motorcycle to a Yamaha dealer immediately for repair.

Sidestand/clutch switch operation check

Check the operation of the sidestand switch and clutch switch against the information below.

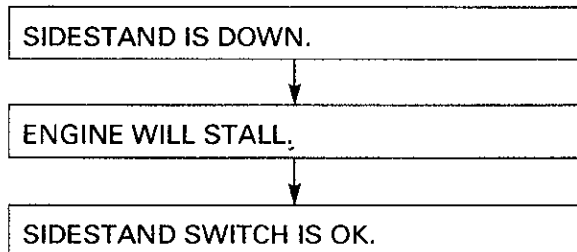
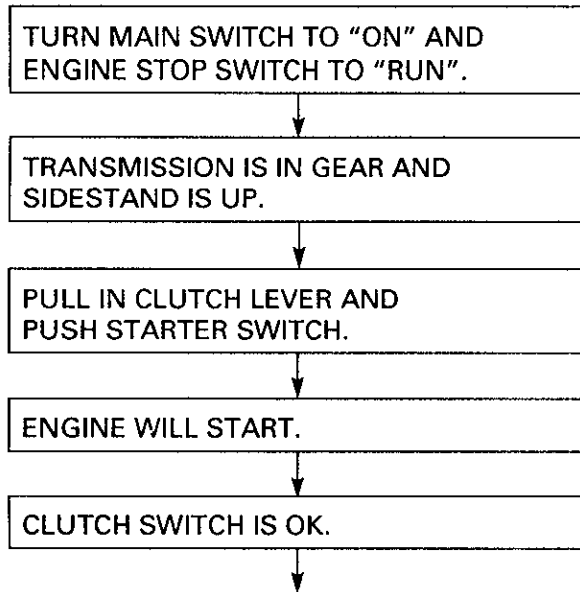

WARNING

If improper operation is noted, consult a Yamaha dealer immediately.

PRE-OPERATION CHECKS

Before using this motorcycle, check the following points:

Item	Routine	Page
Front brake	Check operation, free play, fluid level and fluid leakage. Top-up with DOT#4 brake fluid if necessary.	6-4~6-5, 8-24~8-28
Rear brake	Check operation, free play, fluid level and fluid leakage. Top-up with DOT#4 (or #3) brake fluid if necessary.	
Clutch	Check operation, fluid level and fluid leakage. Top-up with DOT#4 brake fluid if necessary.	6-5, 8-29
Throttle grip/housing	Check for smooth operation. Lubricate/Adjust if necessary.	6-5, 8-21, 8-33
Engine oil	Check oil level/add oil as required.	6-6, 8-8~8-12
Coolant reservoir tank	Check coolant level/top up as required	6-6~6-7, 8-13~8-16
Drive chain	Check chain slack and condition. Adjust if necessary	6-7, 8-30~8-32
Wheels/Tires	Check tire pressure, wear and damage.	6-8~6-13, 8-45~8-50
Control/Meter cable	Check for smooth operation Lubricate if necessary.	8-32
Brake and shift pedal shafts	Check for smooth operation. Lubricate if necessary.	8-33
Brake and clutch lever pivots	Check for smooth operation. Lubricate if necessary.	8-34
Sidestand pivot	Check for smooth operation Lubricate if necessary.	8-34
Fittings/fasteners	Check all chassis fittings and fasteners. Tighten/Adjust if necessary.	6-13, 8-7
Fuel tank	Check fuel level/top-up as required.	6-15~6-16
Lights and signals	Check for proper operation.	6-14, 8-43~8-44

NOTE:

Pre-operation checks should be made each time the motorcycle is used. Such an inspection can be thoroughly accomplished in a very short time; and the added safety it assures is more than worth the time involved.

 WARNING

If any item in the Pre-Operation Check is not working properly, have it inspected and repaired before operating the motorcycle.

Brakes (See page 8-24 for details)

1. Brake lever and brake pedal
Check for correct free play in the front brake lever and rear brake pedal and adjust if necessary. Make sure the brakes are working properly by checking at low speed shortly after starting out.

WARNING

A soft, spongy feeling in the brake lever (and/or brake pedal) indicates a failure in the brake system. Do not operate the motorcycle until the failure in the brake system is corrected. Ask a Yamaha dealer for immediate repairs. A soft, spongy feeling could indicate a hazardous condition in the brake system.

2. Brake fluid
Check the brake fluid level. Add fluid if necessary.

Recommended brake fluid: DOT #4

NOTE: _____
If DOT #4 is not available, #3 can be used for the rear brake only.

3. Check the disc pads.
Refer to page 8-26.

NOTE: _____
When this brake service is necessary, consult a Yamaha dealer.

Brake/Clutch fluid leakage

Apply each brake and the clutch for a few minutes. Check to see if any brake fluid leaks out from the hose, joints, master cylinders, or plunger case.

CAUTION:

Brake fluid may deteriorate painted surfaces or plastic parts. Never spill any fluid. If spilled, clean it up immediately.

⚠ WARNING

If brake fluid leakage is found, ask a Yamaha dealer for immediate repairs. Such leakage could indicate a hazardous condition.

Throttle grip (See page 8-21 for details)

Turn the throttle grip to see if it operates properly, and check the free play. If the free play is incorrect, adjust it. Make sure the grip returns by spring force when released. Ask a Yamaha dealer to make any necessary adjustments.

Engine oil (See page 8-8 for details)

Make sure the engine oil is at the specified level. Add oil as necessary.

Recommended oil:

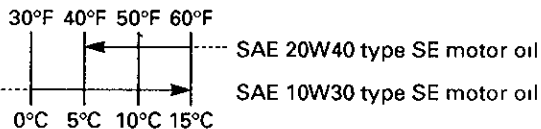

Oil quantity:

Total amount:

4.0 L (3.5 Imp qt, 4.2 US qt)

Periodic oil change:

3.0 L (2.6 Imp qt, 3.2 US qt)

With oil filter replacement:

3.2 L (2.8 Imp qt, 3.4 US qt)

NOTE:

Recommended engine oil classification; API Service "SE", "SF" type or equivalent (e.g. "SF-SE", "SF-SE-CC", "SF-SE-SD" etc.).

Coolant (See page 8-13 for details)

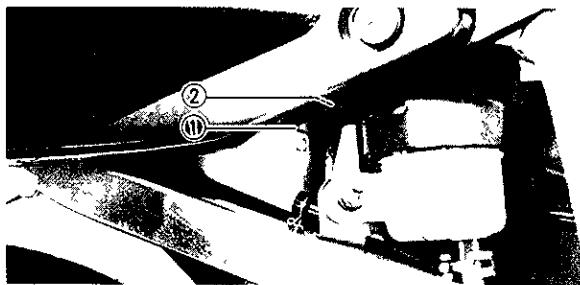

1 "LOW" level

2 "FULL" level

Check the coolant level in the reservoir tank when the engine is cold. (The coolant level will vary with engine temperature.) The coolant level is satisfactory if it is between the "FULL" and "LOW" marks on the tank. If the coolant level is at or below the "LOW" level, add tap water (soft water) to bring the level up to "FULL". Change the coolant every two years.

⚠ WARNING

Do not remove the radiator cap when the engine is hot.

CAUTION:

Hard water or salt water is harmful to the engine. You may use distilled water if you can't get soft water.

Reservoir tank capacity:

0.55 L (0.48 Imp qt, 0.58 US qt)

From "LOW" to "FULL" level:

0.25 L (0.22 Imp qt, 0.26 US qt)

Chain (See page 8-30 for details)

Check the general condition of the chain and the chain slack before every ride. Lubricate and adjust the chain as necessary.

Tires

To ensure maximum performance, long service, and safe operation, note the following:

1. Tire air pressure

Always check and adjust the tire pressure before operating the motorcycle.

WARNING

Tire inflation pressure should be checked and adjusted when the temperature of the tire equals the ambient air temperature. Tire inflation pressure must be adjusted according to total weight of cargo, rider, passenger, and accessories (fairing, saddlebags, etc. if approved for this model), and vehicle speed.

Basic weight With oil and full fuel tank	218 kg (481 lbs)	
Maximum load*	172 kg (379 lbs)	
Cold tire pressure*	Front	Rear
Up to 90 kg (198 lbs) load*	225 kPa (2.5 kgf/cm ² , 32 psi)	250 kPa (2.5 kgf/cm ² , 36 psi)
90 kg (198 lbs) load ~ Maximum load*	250 kPa (2.5 kgf/cm ² , 36 psi)	290 kPa (2.9 kgf/cm ² , 42 psi)
High speed riding	250 kPa (2.5 kgf/cm ² , 36 psi)	290 kPa (2.9 kgf/cm ² , 42 psi)

* Load is the total weight of cargo, rider, passenger, and accessories

⚠ WARNING

Proper loading of your motorcycle is important for several characteristics of your motorcycle; such as handling, braking, performance and safety. Do not carry loosely packed items that can shift. Securely pack your heaviest items close to the center of the motorcycle, and distribute the weight evenly from side to side. Properly adjust the suspension for your load, and check the condition and pressure of your tires. **NEVER OVERLOAD YOUR MOTORCYCLE.** Make sure the total weight of the cargo, rider, passenger, and accessories (fairing, saddlebags, etc. if approved for this model) does not exceed the maximum load of the motorcycle. Operation of an overloaded motorcycle could cause tire damage, an accident, or even injury.

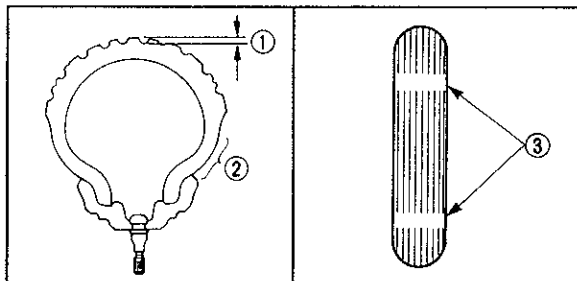

1 Tread depth 2. Side wall 3. Wear indicator

2. Tire inspection

Always check the tires before operating the motorcycle. If a tread depth shows crosswise lines (minimum tread depth), if the tire has a nail or glass fragments in it, or if the side wall is cracked, contact a Yamaha dealer immediately and have him replace the tire.

⚠ WARNING

It is dangerous to ride with a worn-out tire. When a tire tread begins to show lines, have a Yamaha dealer replace the tire immediately. Brakes, tires, and related wheel parts replacement should be left to a Yamaha Service Technician.

Minimum tire tread depth (front and rear)	1.0 mm (0.04 in)
--	------------------

3. Tire information

This motorcycle is equipped with tubeless tires, tire valves and cast wheels.

⚠ WARNING

- After extensive tests, the tires mentioned below have been approved by Yamaha Motor Co., Ltd. for this model. No guarantee for handling characteristics can be given if tire combinations other than what is approved are used on this motorcycle. The front and rear tires should be of the same manufacture and design.
- The use of tire valves and valve cores other than listed below could cause tire deflation during extreme high speed riding. Always use genuine parts or their equivalent for replacement.
- Be sure to install the valve caps securely, as these are important to prevent air pressure leakage during extreme high speed riding.

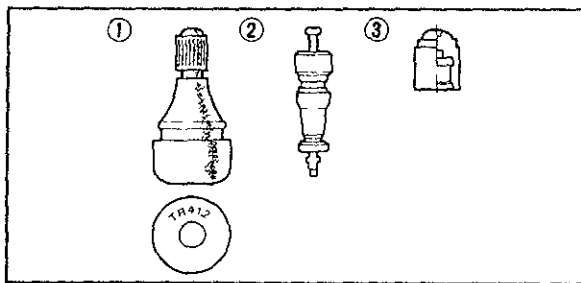

1 Tire valve 2. Valve core 3 Valve cap with seal

FRONT

Manufacturer	Size	Type
Michelin	120/70 ZR17	A89X
Bridgestone	120/70 ZR17	BT50F
Dunlop	120/70 ZR17	D202F

REAR

Manufacturer	Size	Type
Michelin	180/55 ZR17	M89X
Bridgestone	180/55 ZR17	BT50R
Dunlop	180/55 ZR17	D202

	Type
Tire valve	TR412
Valve core	#9000A (Genuine)

⚠ WARNING

This motorcycle is fitted with super high-speed running tires. The following points must be observed in order for you to make fully effective use of these tires.

1. Never fail to use the specified tires in tire replacement. Other tires may have a danger of bursting at super high-speeds.
2. New tires have a relatively low grip on the road surface until they have been slightly worn. Therefore, approximately 100 km (60 mi) should be traveled at normal speed before any high-speed riding is done.
3. Before any high-speed runs, the tires should be warmed-up sufficiently.
4. Always inflate to the correct tire pressure according to the operating conditions.

Tubeless tires and cast wheels

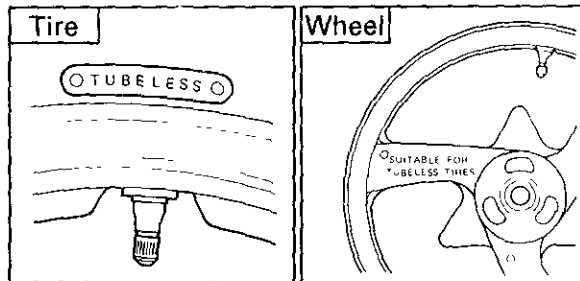

This motorcycle is equipped with cast wheels designed for either tube-type or tubeless tires. Tubeless tires are installed as standard equipment.

⚠ WARNING

Do not attempt to use tubeless tires on a wheel designed for use only with tube-type tires. Tire failure and personal injury may result from sudden deflation.

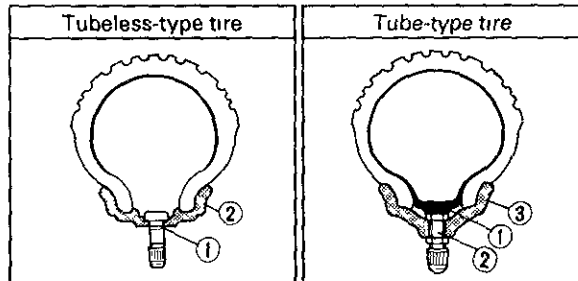

- 1 Air valve
- 2 Cast wheel
(Tubeless wheel)

- 1 Tube
- 2 Air valve
- 3 Cast wheel

Tube-type Wheel

→ Tube-type Tires only

Tubeless Wheel

→ Tube-type or Tubeless tires

⚠ WARNING

When using tube-type tires, be sure to install the proper tube also.

To ensure maximum performance, long service, and safe operation, note the following:

1. Always inspect the wheels before a ride. Check for cracks, bends, or warpage of the wheels. If any abnormal condition exists in a wheel, consult a Yamaha dealer.
Do not attempt even small repairs to the wheel. If a wheel is deformed or cracked, it must be replaced.
2. Tires and wheels should be balanced whenever either one is changed or replaced. Failure to have a wheel balanced can result in poor performance, adverse handling characteristics, and shortened tire life.
3. After installing a tire, ride conservatively to allow the tire to seat itself on the rim properly. Failure to allow proper seating may cause tire failure, resulting in damage to the motorcycle and injury to the rider.

Fittings/Fasteners

Always check the tightness of chassis fittings and fasteners before a ride. Use the chart on page 8-7 to find the correct torque.

Lights and signals

Check the headlight, flasher lights, tail-light, brake light, meter lights, license light, and all the indicator lights to make sure they are in working condition.

Switches

Check the operation of the headlight switch, turn switch, brake light switch, horn switch, starter switch, main switch, etc.

Fuel

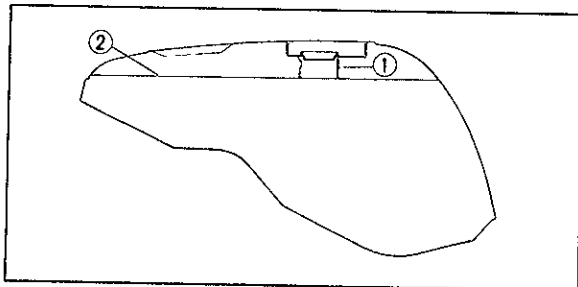

1 Filler tube

2 Fuel level

Make sure there is sufficient fuel in the tank.

⚠ WARNING

Do not overfill the fuel tank. Avoid spilling fuel on the hot engine. Do not fill the fuel tank above the bottom of the filler tube as shown in the illustration or it may overflow when the fuel heats up later and expands.

CAUTION

This fuel tank is fitted with a non-vent tank cap. Always use the correct cap whenever replacement is necessary.

CAUTION

Always wipe off spilled fuel immediately with a dry and clean soft cloth. Fuel may deteriorate painted surfaces or plastic parts.

Recommended fuel:

Regular gasoline

For Australia:

Unleaded fuel only

Fuel tank capacity:

Total:

19 L (4.2 Imp gal, 5.0 US gal)

Reserve:

3.5 L (0.8 Imp gal, 0.9 US gal)

OPERATION AND IMPORTANT RIDING POINTS

WARNING

Before riding this motorcycle, become thoroughly familiar with all operating controls and their functions. Consult a Yamaha dealer regarding any control or function that you do not thoroughly understand.

WARNING

1. Never start your engine or let it run for any length of time in a closed area. The exhaust fumes are poisonous and can cause loss of consciousness and death within a short time. Always operate your motorcycle in an area with adequate ventilation.
 2. Before starting out, always be sure the sidestand is up. Failure to retract the sidestand completely can result in a serious accident when you try to turn a corner.
-

Starting and warming up a cold engine

NOTE:

This motorcycle is equipped with a starting and an ignition circuit cut-off switch.

1. The engine can be started only under the following conditions:
 - a. The transmission is in neutral.
 - b. The sidestand is up, the transmission is in gear, and the clutch is disengaged.
 2. The motorcycle must not be ridden when the sidestand is down.
-

WARNING

Before going through the following steps, check the function of the sidestand switch and clutch switch. (Refer to page 5-24.)

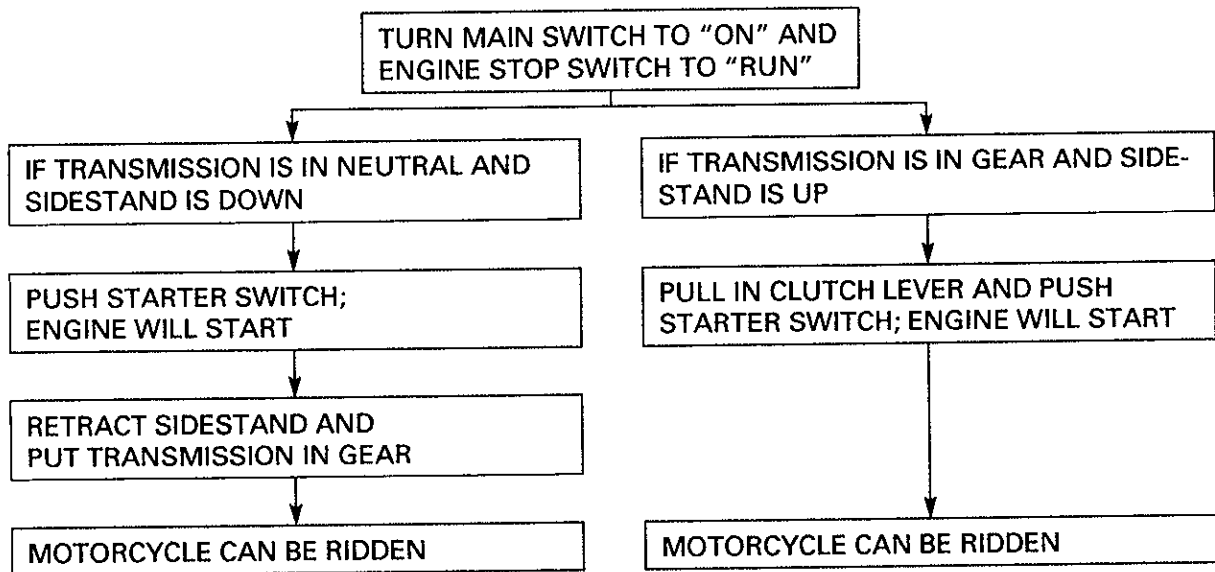

1. Turn the main switch to "ON" and the engine stop switch to "RUN".

CAUTION: _____

If the fuel level indicator light comes on, check the fuel level. If necessary, add fuel.

2. Shift transmission into neutral.

NOTE: _____

When the transmission is in neutral, the neutral indicator light (green) should be on. If the light does not come on, ask a Yamaha dealer to inspect it.

3. Fully open the starter (CHOKE) and completely close the throttle grip.
4. Start the engine by pushing the starter switch.

NOTE: _____

If the engine fails to start, release the starter switch, wait a few seconds, then try again. Each attempt should be as short as possible to preserve the battery. Do not crank the engine more than 10 seconds on any one attempt.

CAUTION: _____

The oil level indicator light and fuel level indicator light should come on when the starter switch is pushed and should go off when the starter switch is released. If the oil level indicator light flickers or remains on, immediately stop the engine and check the engine oil level and for oil leakage. If necessary, replenish oil and check to see that the oil level indicator light goes off. If not, consult a Yamaha dealer.

5. After starting the engine, turn back the starter (CHOKE) to warming up position (about halfway).

NOTE:

For maximum engine life, always warm up the engine before starting off. Never accelerate hard with a cold engine.

6. After warming up the engine, turn off the starter completely.

NOTE:

The engine is warm when it responds normally to the throttle with the starter turned off.

Starting a warm engine

The starter (CHOKE) is not required when the engine is warm.

CAUTION:

See "Break-in section" prior to operating the motorcycle for the first time.

Shifting

The transmission lets you control the amount of power you have available at a given speed for starting, accelerating, climbing hills, etc. The use of the shift pedal is shown in the illustration. (Page 5-13) To shift into NEUTRAL, depress the shift pedal repeatedly until it reaches the end of its travel (you will feel a stop when you are in first gear), then raise the pedal slightly.

CAUTION

- 1. Do not coast for long periods with the engine off, and do not tow the motorcycle a long distance. Even with gears in neutral, the transmission is only properly lubricated when the engine is running. Inadequate lubrication may damage the transmission.**
 - 2. Always use the clutch when changing gears. The engine, transmission, and driveline are not designed to withstand the shock of forced shifting and can be damaged by shifting without using the clutch.**
-

Engine break-in

There is never a more important period in the life of your motorcycle than the period between zero and 1,000 km (600 mi). For this reason we ask that you carefully read the following material. Because the engine is brand new, you must not put an excessive load on it for the first 1,000 km (600 mi). The various parts in the engine wear and polish themselves to the correct operating clearances. During this period, prolonged full throttle operation, or any condition which might result in excessive heating of the engine, must be avoided.

1. 0 ~ 150 km (0 ~ 90 mi):
Avoid operation above 5,500 r/min. Stop the engine and let it cool for 5 to 10 minutes after every hour of operation. Vary the speed of the motorcycle from time to time. Do not operate it at one set throttle position.
2. 150 ~ 500 km (90 ~ 300 mi):
Avoid prolonged operation above 6,500 r/min. Rev the motorcycle freely through the gears, but do not use full throttle at any time.
3. 500 ~ 1,000 km (300 ~ 600 mi):
Avoid prolonged full throttle operation. Avoid cruising speeds in excess of 7,500 r/min.

CAUTION: _____

After 1,000 km (600 mi) of operation, be sure to replace the engine oil and oil filter element.

4. 1,000 km (600 mi) and beyond:
Full throttle can be used.

CAUTION: _____

Never let engine speeds enter the red zone.

CAUTION: _____

If any engine trouble should occur during the break-in period, consult a Yamaha dealer immediately.

Parking

When parking the motorcycle, stop the engine and remove the ignition key.

WARNING

The muffler and exhaust pipe are hot. Park the motorcycle in a place where pedestrians or children are not likely to touch the motorcycle. Do not park the motorcycle on a slope or soft ground; the motorcycle may overturn.

PERIODIC MAINTENANCE AND MINOR REPAIR

Periodic inspection, adjustment and lubrication will keep your motorcycle in the safest and most efficient condition possible. Safety is an obligation of the motorcycle owner. The maintenance and lubrication schedule chart should be considered strictly as a guide to general maintenance and lubrication intervals. YOU MUST TAKE INTO CONSIDERATION THAT WEATHER, TERRAIN, GEOGRAPHICAL LOCATIONS, AND A VARIETY OF INDIVIDUAL USES ALL TEND TO DEMAND THAT EACH OWNER ALTER THIS TIME SCHEDULE TO SHORTER INTERVALS TO MATCH THE ENVIRONMENT. The most important points of motorcycle inspection, adjustment, and lubrication are explained in the following pages.

 WARNING

If you are not familiar with motorcycle service, this work should be done by a Yamaha dealer.

Tool kit

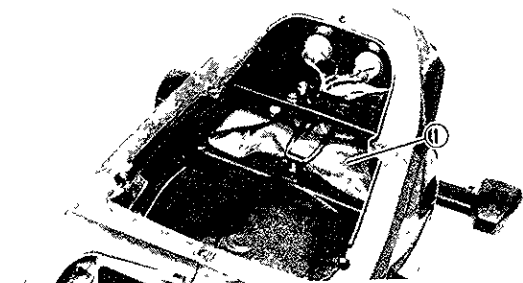

1 Tool kit

The service information included in this manual is intended to provide you, the owner, with the necessary information for completing some of your own preventive maintenance and minor repairs. The tools provided in the owner's tool kit are to assist you in the performance of periodic maintenance. However, some other tools such as a torque wrench are also necessary to perform the maintenance correctly.

NOTE: _____
If you do not have necessary tools required during a service operation, take your motorcycle to a Yamaha dealer for service.

⚠ WARNING

Modifications to this motorcycle not approved by Yamaha may cause loss of performance, and render it unsafe for use. Consult a Yamaha dealer before attempting any changes.

PERIODIC MAINTENANCE / LUBRICATION

Item	Remarks	Break-in 1,000 (600)	Unit km (miles)	
			EVERY	
			6,000 (4,000) or 6 months	12,000 (8,000) or 12 months
Valve(s)*	Check valve clearance Adjust if necessary.	EVERY 42,000 (26,000) or 42 months		
Spark plug(s)	Check condition Clean or replace if necessary	○	○	○
Air filter	Clean. Replace if necessary		○	○
Carburetor*	Check idle speed/synchronization/starter operation Adjust if necessary	○	○	○
Fuel line*	Check fuel hose and vacuum pipe for cracks or damage Replace if necessary		○	○
Engine oil	Replace (Warm engine before draining)	○	○	○
Engine oil filter*	Replace	○		○
Brake*	Check operation/fluid leakage/See NOTE (Page 8-6) Correct if necessary		○	○
Clutch*	Check operation/fluid leakage/See NOTE (Page 8-6) Correct if necessary		○	○
Rear arm pivot*	Check rear arm assembly for looseness Correct if necessary Moderately repack every 24,000 (16,000) or 24 months ***			○
Rear suspension link pivots*	Check operation Apply grease lightly every 24,000 (16,000) or 24 months ***			○
Wheel*	Check balance/damage/runout Repair if necessary		○	○
Wheel bearings*	Check bearing assembly for looseness/damage Replace if damaged		○	○

Item	Remarks	Break-in 1,000 (600)	EVERY	
			6,000 (4,000) or 6 months	12,000 (8,000) or 12 months
Steering bearing*	Check bearing assembly for looseness Correct if necessary. Moderately repack every 24,000 (16,000) or 24 months **	○		○
Front forks*	Check operation/oil leakage. Repair if necessary.		○	○
Rear shock absorber*	Check operation/oil leakage. Repair if necessary.		○	○
Cooling system	Check coolant leakage. Repair if necessary. Replace coolant every 24,000 (16,000) or 24 months		○	○
Drive chain	Check chain slack/alignment. Adjust if necessary Clean and lube.	EVERY 500 (300)		
Fittings/Fasteners*	Check all chassis fittings and fasteners. Correct if necessary.	○	○	○
Sidestand*	Check operation. Repair if necessary	○	○	○
Sidestand switch*	Check operation. Repair if necessary	○	○	○

* . It is recommended that these items be serviced by a Yamaha dealer

** . Medium weight wheel bearing grease

*** . Molybdenum disulfide grease

NOTE:

Brake fluid replacement:

1. When disassembling the master cylinder, caliper cylinder or clutch release cylinder, replace the brake fluid. Normally check the brake fluid level and add fluid as required.
 2. On the inner parts of the master cylinder, caliper cylinder and clutch release cylinder, replace the oil seals every two years.
 3. Replace the brake and clutch hoses every four years, or if cracked or damaged.
-

Torque specifications

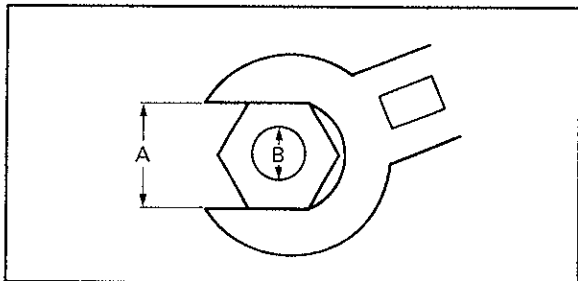

Use a torque wrench to tighten these items. It is recommended that these items be checked occasionally, especially before a long trip. Always check the tightness of these items whenever they are loosened for any reason.

A (Nut)	B (Bolt)	General torque specifications		
		Nm	m·kg	ft·lb
10 mm	6 mm	6	0.6	4.3
12 mm	8 mm	15	1.5	11
14 mm	10 mm	30	3.0	22
17 mm	12 mm	55	5.5	40
19 mm	14 mm	85	8.5	61
22 mm	16 mm	130	13.0	94

Item	Torque		
	Nm	m·kg	ft·lb
Spark plug	18	1.8	13
Engine oil drain plug	43	4.3	31
Oil filter	17	1.7	12
Coolant drain bolt	10	1.0	7
Front axle pinch bolt	23	2.3	17
Front axle	72	7.2	52
Caliper bolt (Front)	35	3.5	25
Rear axle nut	203	20.3	146
Caliper bolt (Rear)	35	3.5	25
Seat grip bolt	7	0.7	5.1

Engine oil

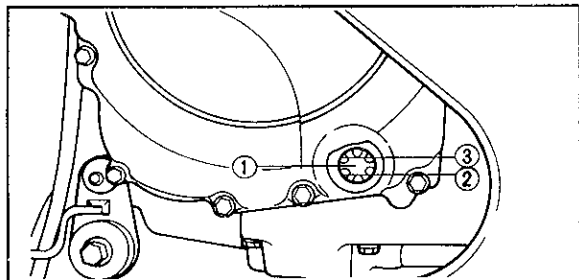

1 Level window 2 Minimum level 3 Maximum level

1. Oil level measurement

- a. Place the motorcycle on a level place and hold it in an upright position. Warm up the engine for several minutes.

NOTE: _____

Be sure the motorcycle is positioned straight up when checking the oil level. A slight tilt toward the side can result in false readings.

- b. With the engine stopped, check the oil level through the level window located at the lower part of the right side crankcase cover.

NOTE: _____

Wait a few minutes until the oil level settles before checking.

- c. The oil level should be between maximum and minimum marks. If the level is low, add oil to raise it to the proper level.

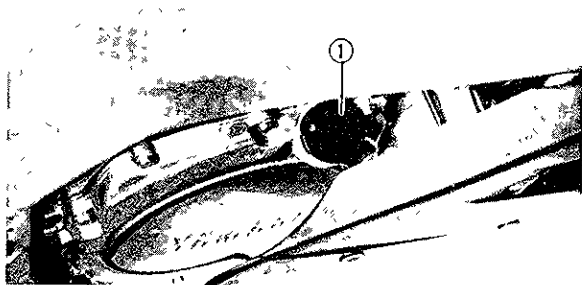

1. Oil filler cap

2. Engine oil and oil filter replacement

- a. Remove the lower cowl.
- b. Warm-up the engine for a few minutes.
- c. Stop the engine. Place an oil pan under the engine, and remove the oil filler cap.

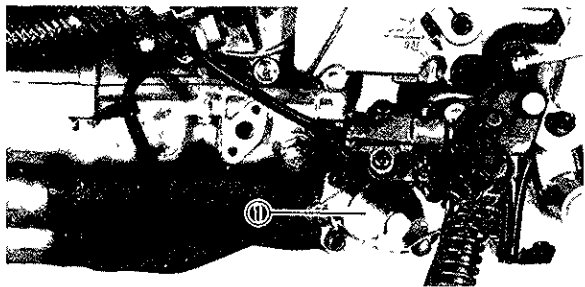

1. Engine oil drain plug

- d. Remove the drain plug and drain the oil.



1 Oil filter

2. Oil filter wrench

- e. Remove the oil filter by using an oil filter wrench.

NOTE: _____

An oil filter wrench is available at a nearby Yamaha dealer.

- f. Reinstall the drain plug (make sure it is tight).

Drain plug torque:

43 Nm (4.3 m·kg, 31 ft·lb)

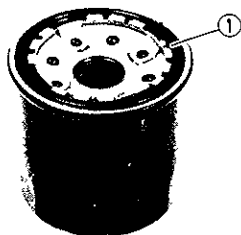

1 O-ring

- g. Apply a light coat of engine oil to the O-ring of new oil filter.

NOTE: _____

Make sure the O-ring is seated properly.

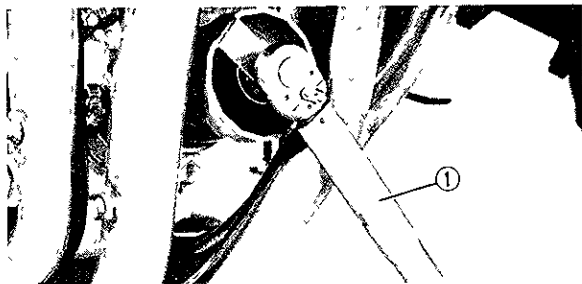

1. Torque wrench

- h. Install the new oil filter, and tighten it by using an oil filter wrench.

NOTE:

When installing the oil filter, tighten it to the proper torque by using a torque wrench.

Oil filter torque:

17 Nm (1.7 m·kg, 12 ft·lb)

- i. Fill engine with oil. Install the oil filler cap and tighten.

Recommended oil:

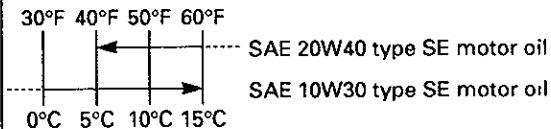

Oil quantity:

Total amount:

4.0 L (3.5 Imp qt, 4.2 US qt)

Periodic oil change:

3.0 L (2.6 Imp qt, 3.2 US qt)

With oil filter replacement:

3.2 L (2.8 Imp qt, 3.4 US qt)

NOTE:

Recommended engine oil classification; API Service "SE", "SF" type or equivalent (e.g. "SF-SE", "SF-SE-CC", "SF-SE-SD" etc.).

CAUTION: _____

Do not put in any chemical additives. Engine oil also lubricates the clutch and additives could cause clutch slippage.

CAUTION: _____

Be sure no foreign material enters the crankcase.

- j. Start the engine and warm up for a few minutes. While warming up, check for oil leakage. If oil leakage is found, stop the engine immediately, and check for the cause.
- k. After the engine is started, the oil indicator light should go off if oil is filled to proper level.

CAUTION: _____

If the indicator light flickers or remains on, immediately stop the engine and consult a Yamaha dealer.

- l. Install the lower cowl.

Cooling system

1. If your motorcycle overheats.

⚠ WARNING

Do not remove the radiator cap when the engine and radiator are hot. Scalding hot fluid and steam may be blown out under pressure, which could cause serious injury. When the engine has cooled, open the radiator cap by the following procedure. Place a thick rag, like a towel, over the radiator cap, slowly rotate the cap counterclockwise to the detent. This procedure allows any residual pressure to escape. When the hissing sound has stopped, press down on the cap while turning counterclockwise and remove it.

If overheating is detected, perform the following checks.

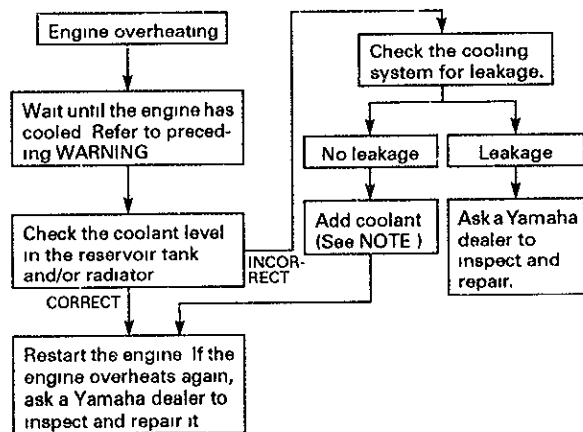

NOTE:

If it is difficult to get the recommended coolant, tap water can be temporarily used, provided that it is changed to the recommended coolant as soon as possible.

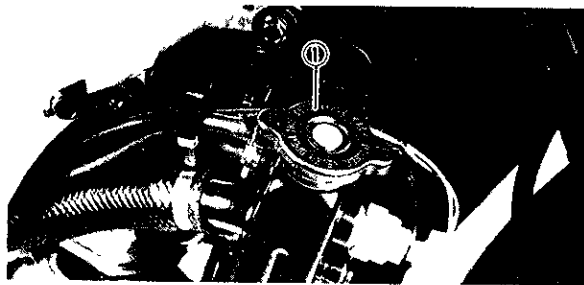

1 Radiator cap

2. Changing the coolant

- a. Remove the seat, lower cowl and side cowl.
- b. Place a container under the engine.
- c. Remove the radiator cap.

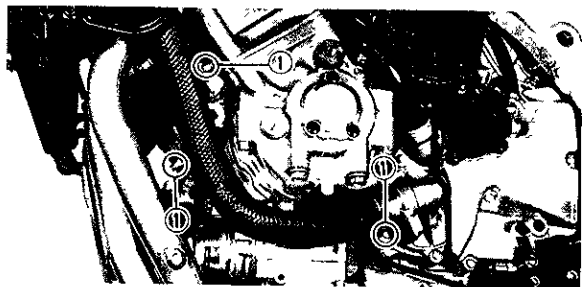

1 Drain bolts

- d. Remove the drain bolts.
- e. Disconnect the reservoir tank pipe on the reservoir tank side, and drain the reservoir tank of its coolant.
- f. Drain the coolant completely, and thoroughly flush the cooling system with clean tap water.
- g. Retighten the drain bolts. If the gasket is damaged, replace it.

Tightening torque:

Drain bolts:

10 Nm (1.0 m·kg, 7 ft·lb)

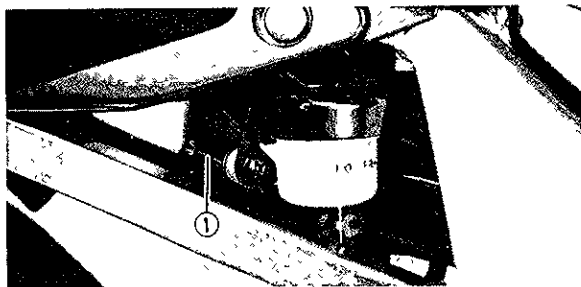

1 Reservoir tank pipe

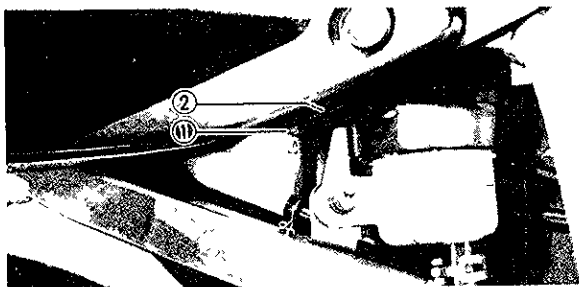

1 "LOW" level

2 "FULL" level

- h. Reinstall the reservoir tank pipe.
- i. Pour the recommended coolant into the radiator until the radiator is full.

Recommended coolant:

High quality ethylene glycol anti-freeze containing corrosion inhibitors for aluminum engines.

Coolant and water mix ratio:

50%/50%

Total amount:

2.4L (2.11 Imp qt, 2.54 US qt)

Reservoir tank capacity:

(From "LOW" to "FULL" level)

0.25 L (0.22 Imp qt, 0.26 US qt)

CAUTION:

Hard water or salt water is harmful to the engine. You may use distilled water if you can't get soft water.

- j. Reinstall the radiator cap.
- k. Run the engine several minutes and recheck the coolant level in the radiator. If it is low, add more coolant until it reaches the top of the radiator.
- l. Fill the reservoir tank with coolant up to "FULL" level.

Electric fan

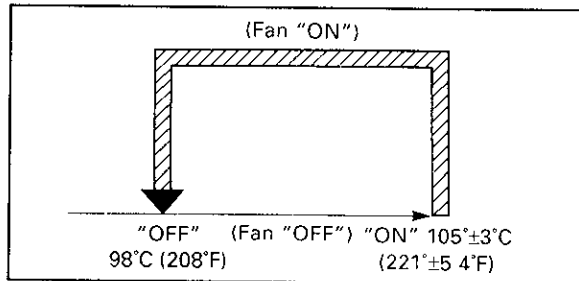

- m. Reinstall the reservoir tank cap and check for coolant leakage.

NOTE:

If you find any leaks, ask a Yamaha dealer to inspect.

- n. Reinstall the side cowls, lower cowl and seat.

Operation

The electric fan operation is completely automatic. It will be switched "ON" or "OFF" according to the coolant temperature in the radiator.

Air filter

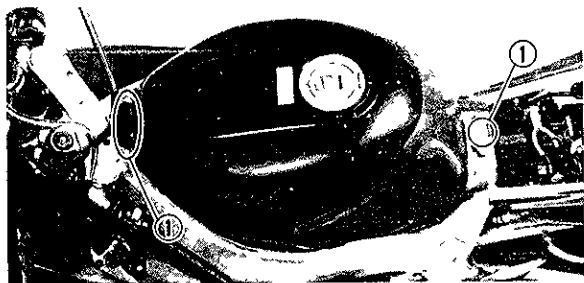

1 Bolts

The element should be cleaned at the specified intervals. It should be cleaned more frequently if you are riding in unusually wet or dusty areas.

1. Remove the seat.
2. Remove the bolt(s) holding the fuel tank.
3. Lift the fuel tank upward and position it away from the air cleaner case. (Do not remove the fuel hoses.)

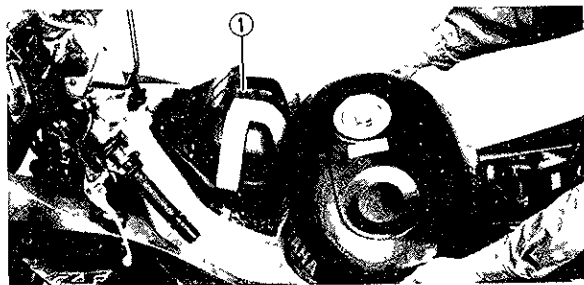

1 Air cleaner case

⚠ WARNING

- Support the fuel tank carefully during this procedure.
- Do not tilt the fuel tank too much or pull it too hard because the fuel hose connections may become loose causing fuel leakage.

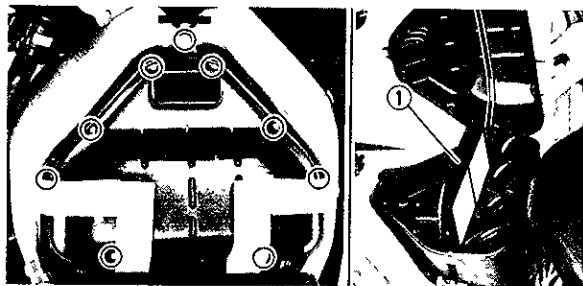

1. Air filter

4. Remove the screws holding the filter case cover.
5. Pull out the air filter.
6. Tap the air filter lightly to remove most of the dust and dirt. Blow out the remaining dirt with compressed air from the outer surface of the air filter. If the air filter is damaged, replace it.
7. Reinstall by reversing the removal procedure.

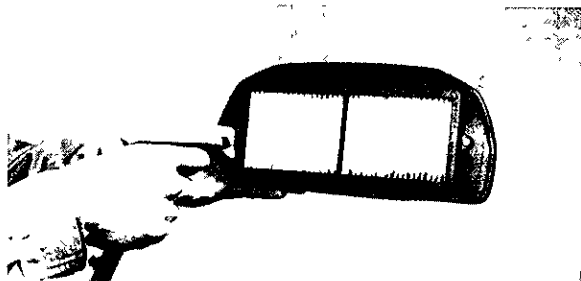

CAUTION:

Make sure the element is properly seated in the filter case.

⚠ WARNING

- Before reinstallation, make sure that the fuel hoses are not damaged at all. If any damage is found, it may result in a fuel leak, so do not start the engine. Ask a Yamaha dealer for repairs.
- Always make sure that the fuel hoses are properly connected, in place, and not pinched.

CAUTION: _____

The engine should never be run without the air filter element installed; excessive piston and/or cylinder wear may result.

CAUTION: _____

Be sure the air filter is installed with the mesh side facing backward.

Carburetor adjustment

The carburetor is a vital part of the engine and requires very sophisticated adjustment. Most adjustments should be left to a Yamaha dealer who has the professional knowledge and experience to do so. However, the following may be serviced by the owner as part of routine maintenance.

CAUTION: _____

The carburetor was set at the Yamaha factory after many tests. If the settings are changed, poor engine performance and damage may result.

Idle speed adjustment

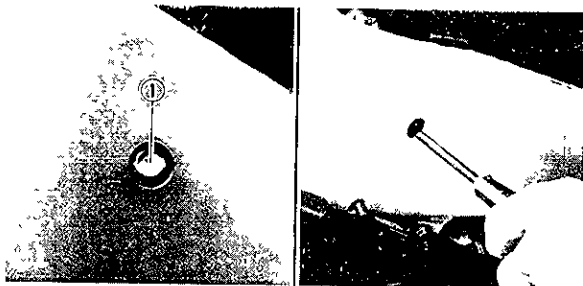

1 Throttle stop screw

1. Start the engine and warm it up for a few minutes (normally, 1 or 2 minutes) at approximately 1,000 to 2,000 r/min. Occasionally rev the engine to 4,000 to 5,000 r/min. The engine is warm when it quickly responds to the throttle.
2. Set the idle to the specified engine speed by adjusting the throttle stop screw; turn the screw in to increase engine speed, and out to decrease engine speed.

Standard idle speed:
1,150 ~ 1,250 r/min

NOTE:

If the specified idle speed cannot be obtained by performing the above adjustment, consult a Yamaha dealer.

Throttle cable adjustment

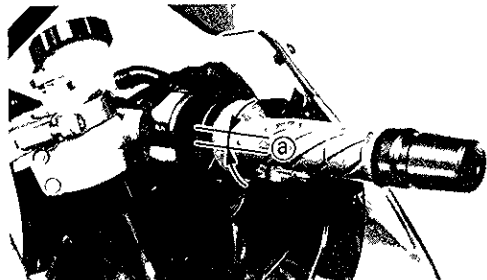

a. Free play

NOTE:

Before adjusting the throttle cable free play, the engine idling speed should be adjusted.

Adjust the throttle cable by turning the adjuster so that proper free play at the throttle grip is obtained.

Free play:

3 ~ 7 mm (0.12 ~ 0.28 in)

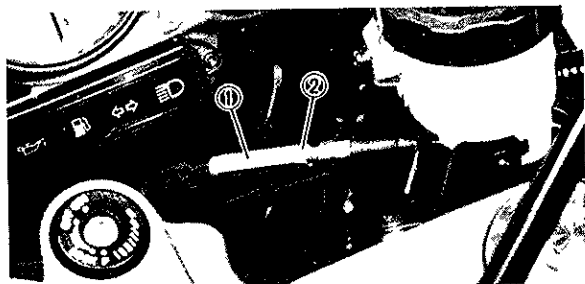

1. Adjuster

2. Lock nut

1. Loosen the lock nut.
2. Turn the adjuster in or out until specified free play is obtained.
3. Tighten the lock nut.

Valve clearance adjustment

The valve clearance becomes larger with use, resulting in improper fuel/air supply and engine noise. To prevent this, the valve clearance must be adjusted regularly. This adjustment, however, should be left to a professional Yamaha service technician.

Spark plug inspection

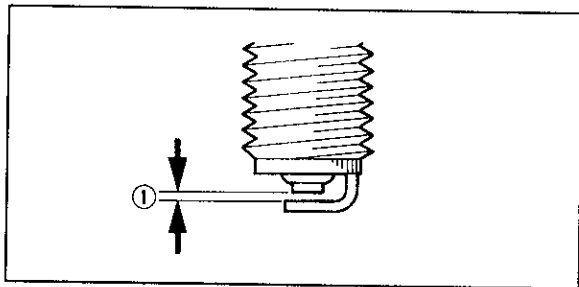

1 Spark plug gap

The spark plug is an important engine component and is easy to inspect. The condition of the spark plug can indicate the condition of the engine.

Normally, all spark plugs from the same engine should have the same color on the white porcelain insulator around the center electrode. The ideal color at this point is a medium to light tan color for a motorcycle that is being ridden normally. If one spark plug shows a distinctly different color, there could be something wrong with the engine.

Do not attempt to diagnose such problems yourself. Instead, take the motorcycle to a Yamaha dealer. You should periodically remove and inspect the spark plugs because heat and deposits will cause any spark plug to slowly break down and erode. If electrode erosion becomes excessive, or if carbon and other deposits are excessive, you should replace the spark plug with the specified plug.

Standard spark plug:
CR8E/CR9E (NGK) or
U24ESR-N/U27ESR-N
(NIPPONDENSO)

Before installing any spark plug, measure the electrode gap with a wire thickness gauge; adjust the gap to specification.

Spark plug gap:
0.7 ~ 0.8 mm (0.028 ~ 0.031 in)

When installing the plug, always clean the gasket surface and use a new gasket. Wipe off any grime from the threads, and torque the spark plug properly.

Spark plug torque:
18 Nm (1.8 m·kg, 13 ft·lb)

NOTE:

If a torque wrench is not available when you are installing a spark plug, a good estimate of the correct torque is 1/4 to 1/2 turn past finger tight. Have the spark plug torqued to the correct value as soon as possible with a torque wrench.

Front brake lever position adjustment

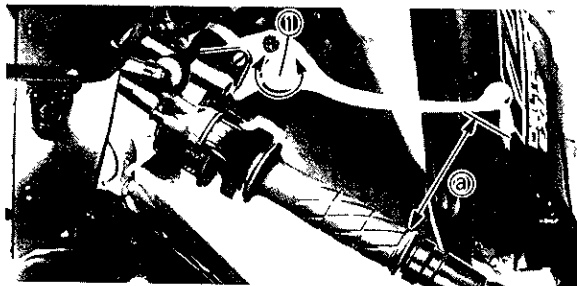

1 Position adjuster

a Lever distance

Brake lever distance from the throttle grip can be adjusted. To adjust, turn the adjuster while pushing the front brake lever forward.

Rear brake adjustment

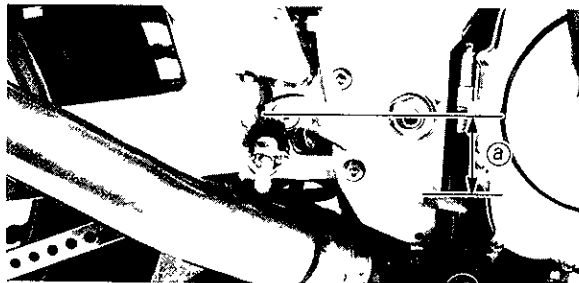

a Pedal height 57 mm (2.2 in)

The top of the brake pedal should be positioned 57 mm (2.2 in) below the top of the footrest. If not, ask a Yamaha dealer to adjust it.

Brake light switch adjustment

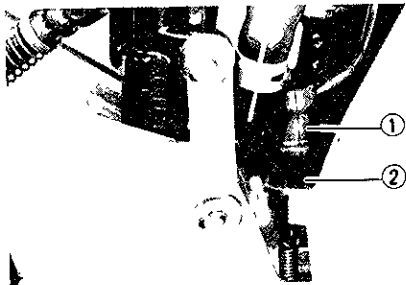

1 Main body

2. Lock nut

⚠ WARNING

A soft or spongy feeling in the brake pedal can indicate the presence of air in the brake system. This air must be removed by bleeding the brake system before the motorcycle is operated. Air in the system will cause greatly diminished braking capability and can result in loss of control and an accident. Have a Yamaha dealer inspect and bleed the system if necessary.

The brake light switch is operated by movement of the brake pedal. To adjust, hold the main body of the switch so it does not rotate and turn the adjusting nut. Proper adjustment is achieved when the brake light comes on just before the brake begins to take effect.

Checking the front and rear brake pads

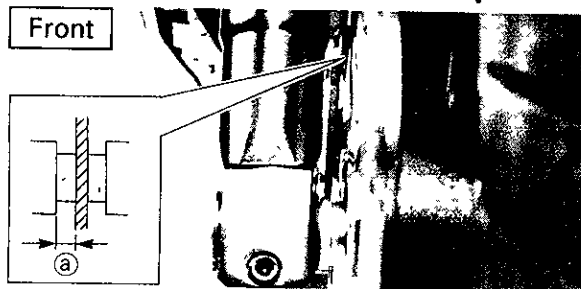

a Wear limit 0.5 mm(0.02 in)

FRONT

Check the brake pads for damage and wear. If the thickness is less than the specified value, have a Yamaha dealer replace the pads.

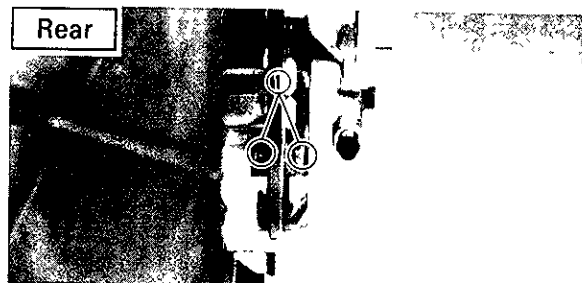

1 Wear indicator

REAR

Apply the brake and inspect the wear indicator. If the wear indicator is **ALMOST** in contact with the disc plate, ask a Yamaha dealer to replace the pads.

Inspecting the brake fluid level



1. Lower level

Insufficient brake fluid may let air enter the brake/clutch system, possibly causing the brakes/clutch to become ineffective. Before riding, check that the brake fluid is above the lower level and replenish when necessary.

Observe these precautions:

1. When checking the fluid level, make sure the top of the master cylinder is level by turning the handlebars.
2. Use only the designated quality brake fluid: otherwise, the rubber seals may deteriorate, causing leakage and poor brake/clutch performance.

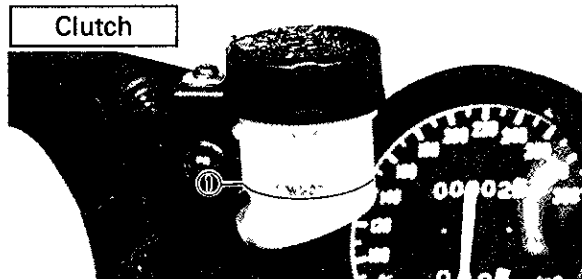

1. Lower level

Recommended brake fluid: DOT#4

NOTE:

(Rear brake fluid only)

If DOT #4 is not available, #3 can be used.

3. Refill with the same type of brake fluid. Mixing fluids may result in a harmful chemical reaction and lead to poor brake/clutch performance.

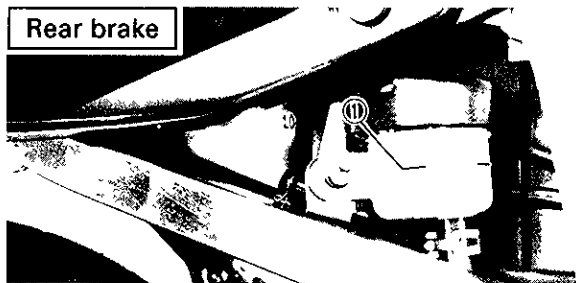

1. Lower level

4. Be careful that water does not enter the master cylinder when refilling. Water will significantly lower the boiling point of the fluid and may result in vapor lock.
5. Brake fluid may deteriorate painted surfaces or plastic parts. Always clean up spilled fluid immediately.
6. Have a Yamaha dealer check the cause if the brake fluid level goes down.

Brake fluid replacement

1. Complete fluid replacement should be done only by trained Yamaha service personnel.
2. Have a Yamaha dealer replace the following components during periodic maintenance or when they are damaged or leaking.
 - a. Replace all rubber seals every two years.
 - b. Replace all hoses every four years.

Clutch lever position adjustment

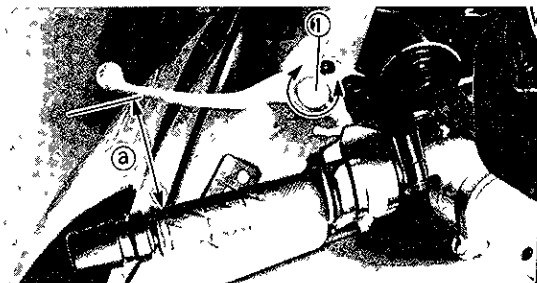

1 Position adjuster

a. Lever distance

Clutch lever distance from the handlebar grip can be adjusted. To adjust, turn the adjuster while pushing the clutch lever forward.

Clutch adjustment

This motorcycle has a hydraulic clutch. There are no adjustments to perform but the clutch system must be inspected periodically for proper fluid level and leakage. If the control lever free play becomes excessive and the motorcycle creeps or stalls when shifted into gear, or if the clutch slips, causing acceleration to lag behind engine speed, there is probably air in the clutch system and it must be bled out. Ask a Yamaha dealer to do this service.

Drive chain slack check

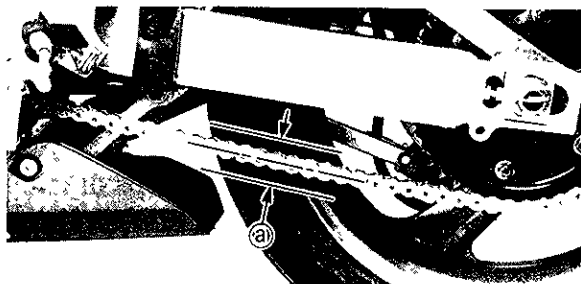

a 20~35 mm (0.8~1.4 in)

NOTE:

Spin the wheel several times and find the tightest position of the chain. Check and/or adjust the chain slack while it's in this tightest position.

To check the chain slack the motorcycle must be held straight up with both wheels on the ground and without rider. Check the slack at the position shown in the illustration. Normal slack is approximately 20 ~ 35 mm (0.8 ~ 1.4 in). If the slack exceeds 35 mm (1.4 in), adjust.

Drive chain slack adjustment

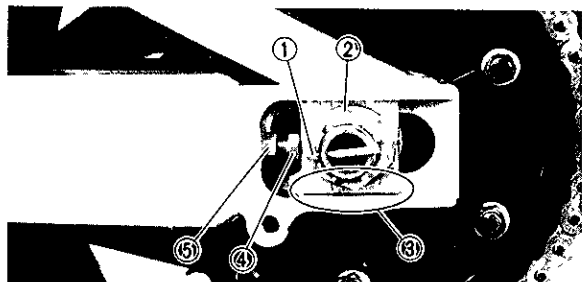

- | | | |
|--------------|------------|-------------------|
| 1 Cotter pin | 2 Axle nut | 3 Alignment marks |
| 4 Adjuster | 5 Lock nut | |

1. Remove the cotter pin from the axle nut.
2. Loosen the axle nut.
3. Loosen the lock nuts on each side. To tighten the chain, turn the chain adjuster counterclockwise. To loosen the chain, turn the adjuster clockwise and push the wheel forward. Turn each adjuster exactly the same amount to maintain correct axle alignment. There are marks on each side of the swingarm. Use these marks to align the rear wheel.

CAUTION

Too little chain slack will overload the engine and other vital parts. Keep the slack within the specified limits.

4. After adjusting, be sure to tighten the lock nuts and the axle nut.

Axle nut torque:
203 Nm (20.3 m·kg, 146 ft·lb)

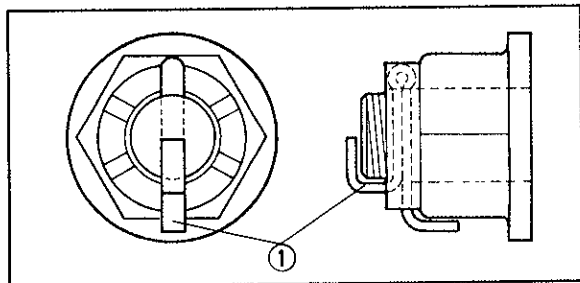

1 Cotter pin

5. Insert a new cotter pin into the axle nut and bend the end of the cotter pin as shown in the illustration. If the notch in the nut and the cotter pin hole do not match, tighten the nut slightly to align them.

WARNING

Always use a new cotter pin on the axle nut.

Drive chain lubrication

The chain consists of many parts which work with each other. If the chain is not maintained properly, it will wear out quickly. Therefore, the chain must be serviced regularly. This service is especially necessary when riding in dusty areas. This motorcycle is equipped with a sealed type chain. Steam cleaning, high-pressure washes, and solvents can damage chain so do not use these for cleaning it. Use only kerosene to clean the drive chain. Wipe it dry, and thoroughly lubricate it with SAE 30 ~ 50W motor oil. Do not use any other lubricants on the drive chain. They may contain solvents that could damage the sealed chain.

Cable inspection and lubrication

WARNING

Damage to the outer housing of cables may allow internal rusting and cause interference with cable movement. Replace damaged cables as soon as possible to prevent unsafe conditions.

Lubricate the inner cable and the cable end. If it does not operate smoothly, ask a Yamaha dealer to replace them.

Recommended lubricant:
SAE 10W30 motor oil

Throttle cable and grip lubrication

The throttle twist grip assembly should be greased at the time that the cable is lubricated, since the grip must be removed to get at the end of the throttle cable. After removing the screws, hold the end of the cable up in the air and put in several drops of lubricant. With the throttle grip disassembled, coat the metal surface of the grip assembly with a suitable all-purpose grease.

Brake and shift pedals

Lubricate the pivoting parts.

Recommended lubricant: SAE 10W30 motor oil

Brake and clutch levers

Lubricate the pivoting parts.

Recommended lubricant:
SAE 10W30 motor oil

Sidestand

Lubricate the pivoting parts. Check to see that the sidestand moves up and down smoothly.

Recommended lubricant:
SAE 10W30 motor oil

WARNING

**If the sidestand does not move smoothly,
consult a Yamaha dealer.**

Rear suspension

Lubricate the pivoting parts.

Recommended lubricant:
Lithium soap base grease

Front fork inspection

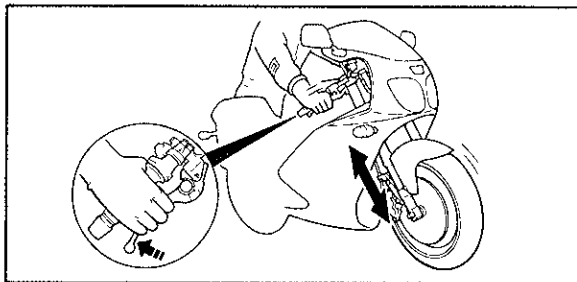

⚠ WARNING

Securely support the motorcycle so there is no danger of it falling over.

1. Visual check
Check for scratches/damage on the inner tube and excessive oil leakage from the front fork.
2. Operation check
Place the motorcycle on a level place.
 - a. Hold the motorcycle in an upright position and apply the front brake.
 - b. Stroke the front forks up and down several times.

Front fork adjustment

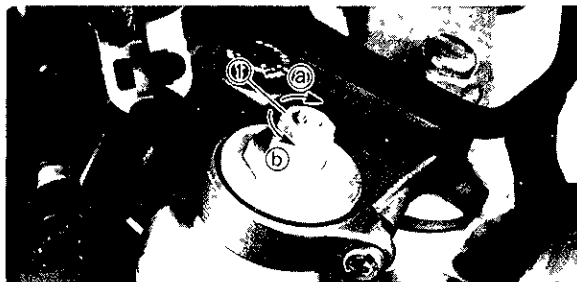

1 Spring preload adjuster

a Increase

b Decrease

This front fork is equipped with a spring preload, rebound and compression damping force adjuster.

⚠ WARNING

Always adjust each fork leg to the same setting. Uneven adjustment can cause poor handling and loss of stability.

1. Adjust spring preload as follows
Turn adjuster in direction Ⓐ to increase spring preload and in direction Ⓑ to decrease spring preload.

CAUTION:

If any damage or unsmooth movement is found with the front fork, consult a Yamaha dealer.

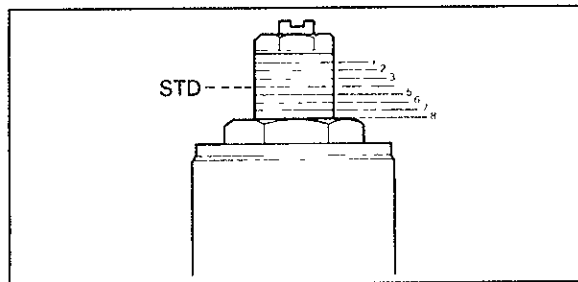

CAUTION:

The grooves are provided to show the adjustment level. Always keep the adjustment level equal on both fork legs.

Adjusting position	HARD			STD	SOFT			
	1	2	3	4	5	6	7	8

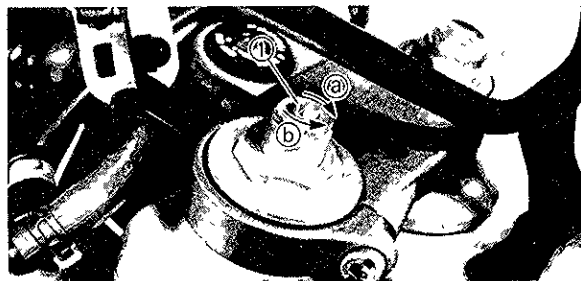

1 Rebound damping force adjuster

a Increase

b Decrease

- Adjust rebound damping force as follows. Turn adjuster in direction **(a)** to increase rebound damping force and in direction **(b)** to decrease rebound damping force.

STD	4 clicks out*
MIN	12 clicks out*
MAX	1 click out*

* From fully-turned in position

CAUTION:

Never attempt to turn the adjuster beyond the maximum or minimum setting.



- 1 Compression damping force adjuster
a Increase b Decrease

- 3 Adjust compression damping force as follows. Turn adjuster in direction (a) to increase compression damping force and in direction (b) to decrease compression damping force.

STD	7 clicks out*
MIN	10 clicks out*
MAX	1 click out*

* From fully-turned in position

CAUTION:

Never attempt to turn the adjuster beyond the maximum or minimum setting.

Rear shock absorber

⚠ WARNING

This shock absorber contains highly pressurized nitrogen gas. Read and understand the following information before handling the shock absorber. The manufacturer cannot be held responsible for property damage or personal injury that may result from improper handling.

1. Do not tamper with or attempt to open the cylinder assembly.
2. Do not subject the shock absorber to an open flame or other high heat source. This may cause the unit to explode due to excessive gas pressure.
3. Do not deform or damage the cylinder in any way. Cylinder damage will result in poor damping performance.
4. Take your shock absorber to a Yamaha dealer for any service.

Rear shock absorber adjustment

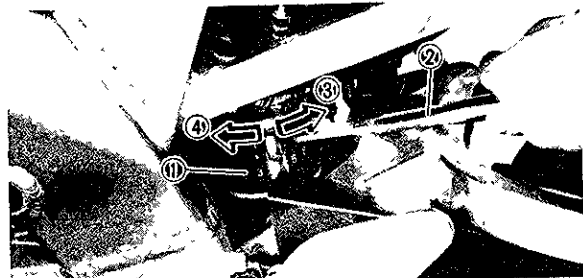

- 1 Spring preload adjuster
2 Special wrench
3 Decrease
4 Increase

This shock absorber is equipped with a spring preload, rebound and compression damping force adjuster.

1. Adjust spring preload as follows.

Turn adjuster in direction ④ to increase spring preload and in direction ③ to decrease spring preload.

NOTE:

When adjusting, use the special wrench which is included in the owner's tool kit.

	HARD				STD	SOFT	
Adjusting position	7	6	5	4	3	2	1

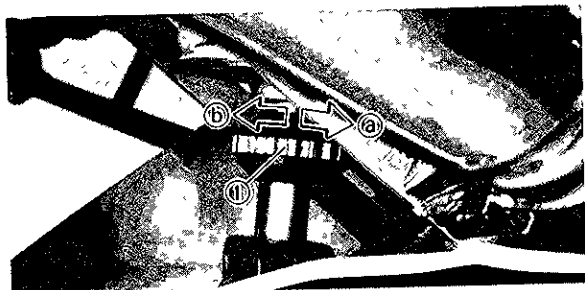

- 1 Rebound damping force adjuster
a Increase
b Decrease

2. Adjust rebound damping force as follows. Turn adjuster in direction ① to increase rebound damping force and in direction ② to decrease rebound damping force.

STD	9 clicks out*
MIN	11 clicks out*
MAX	3 clicks out*

* From fully-turned in position

CAUTION:

Never attempt to turn the adjuster beyond the maximum or minimum setting.

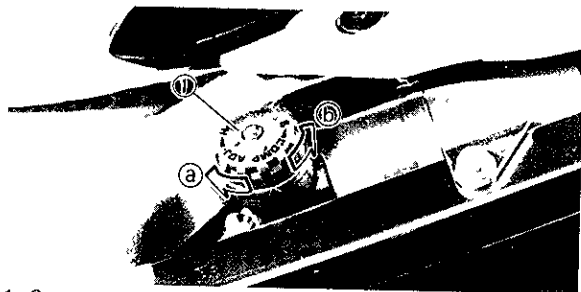

1 Compression damping force adjuster

a Increase

b Decrease

3. Adjust compression damping force as follows. Turn adjuster in direction (a) to increase compression damping force and in direction (b) to decrease compression damping force.

STD	10 clicks out*
MIN	20 clicks out*
MAX	1 click out*

* From fully-turned in position

CAUTION: _____

Never attempt to turn the adjuster beyond the maximum or minimum setting.

Recommended combinations of the front fork and the rear shock absorber settings.
Use this table as a guide for specific riding and motorcycle load conditions.

	Front shock absorber			Rear shock absorber			Loading condition	
	Spring preload adjuster	Compression damping force adjuster	Rebound damping force adjuster	Spring preload adjuster	Compression damping force adjuster	Rebound damping force adjuster	Solo rider	With passenger
1	4 ~ 5	7 ~ 8*	4 ~ 5*	3 ~ 4	9 ~ 11*	8 ~ 9*	○	
2	4 ~ 5	7 ~ 8*	4 ~ 5*	4 ~ 6	6 ~ 9*	6 ~ 8*		○

* From fully-turned in position

CAUTION: _____

Never attempt to turn the adjuster beyond the maximum or minimum setting.

Steering inspection

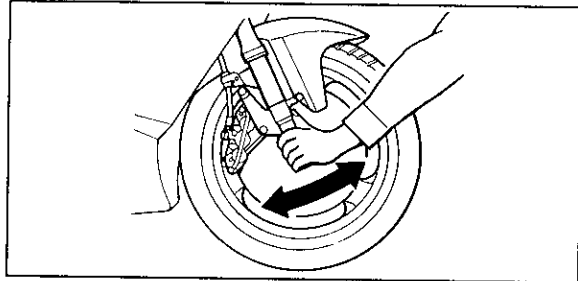

Periodically inspect the condition of the steering. Worn out or loose steering bearings may be dangerous. Place a stand under the engine to raise the front wheel off the ground. Hold the lower end of the front forks and try to move them forward and backward. If any free play can be felt, ask a Yamaha dealer to inspect and adjust the steering. Inspection is easier if the front wheel is removed.

⚠ WARNING

Securely support the motorcycle so there is no danger of it falling over.

Wheel bearings

If there is play in the front or rear wheel hub or if the wheel does not turn smoothly, have a Yamaha dealer inspect the wheel bearings. The wheel bearings should be inspected according to the Maintenance Schedule.

Battery

This motorcycle is equipped with a "Sealed type" battery. Therefore, it is not necessary to check the electrolyte or add distilled water in the battery.

If the battery seems to have discharged, consult a Yamaha dealer.

CAUTION:

Do not try to remove the sealing caps of the battery cells. You may damage the battery.

⚠ WARNING

Battery electrolyte is poisonous and dangerous, causing severe burns, etc. It contains sulfuric acid. Avoid contact with skin, eyes or clothing.

Antidote:

EXTERNAL-Flush with water.

INTERNAL-Drink large quantities of water or milk. Follow with milk of magnesia, beaten egg, or vegetable oil. Call a physician immediately.

EYES: Flush with water for 15 minutes and get prompt medical attention. Batteries produce explosive gases. Keep sparks, flame, cigarettes etc., away. Ventilate when charging or using in an enclosed space. Always shield your eyes when working near batteries.

KEEP OUT OF REACH OF CHILDREN.

Battery maintenance

1. When the motorcycle is not used for a month or longer, remove the battery and store it in a cool, dark place. Completely recharge the battery before re-installation.

CAUTION:

A special battery charger (constant voltage/ampere or constant voltage) is required for recharging the sealed type battery. Using a conventional battery charger may shorten the battery life.

2. Always make sure the connections are correct when reinstalling the battery. The red (positive) lead is for the + terminal and the black (negative) lead is for the - terminal. Always connect the red(positive) lead first, then connect the black(negative) lead.

Fuse replacement

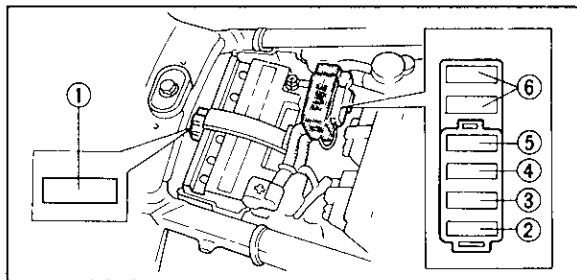

- | | | |
|------------|-------------|----------|
| 1 Main | 2 Headlight | 3 Signal |
| 4 Ignition | 5 Fan | 6 Spare |

1. The fuse box(es) are located under the seat.
2. If any fuse is blown, turn off the ignition switch and the switch of the circuit in question. Install a new fuse of proper amperage. Turn on the switches and see if the electrical device operates. If the fuse immediately blows again, consult a Yamaha dealer.

Headlight bulb replacement

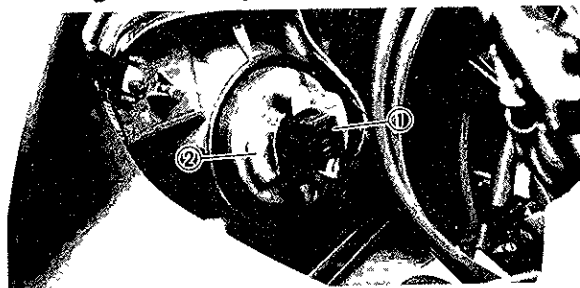

1 Leads

2 Cover

CAUTION:

Do not use fuses of higher amperage rating than those recommended. Substitution of a fuse of improper rating can cause extensive electrical system damage and possibly a fire.

Specified fuse:

Main.	30A
Head:	20A
Signal:	15A
Fan:	7.5A
Ignition:	7.5A

This motorcycle is equipped with a quartz bulb headlight. If the headlight bulb burns out, replace the bulb as follows:

1. Disconnect the headlight leads, and remove the cover.

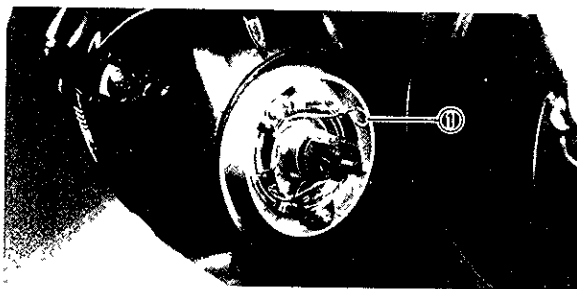

1 Holding spring

2. Unhook the bulb holding spring and remove the defective bulb.

⚠ WARNING

Keep flammable products and your hands away from the bulb while it is on, as it is hot. Do not touch the bulb until it cools down.

3. Put a new bulb into position and secure it in place with the bulb holding spring

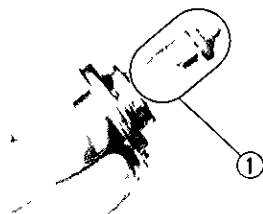

1 Don't touch

CAUTION:

Avoid touching the glass part of the bulb. Keep it free from oil; otherwise, the transparency of the glass, life of the bulb, and illuminous flux will be adversely affected. If oil gets on the bulb, thoroughly clean it with a cloth moistened with alcohol or lacquer thinner.

4. Install the cover and connect the headlight lead(s). If the headlight beam adjustment is necessary, ask a Yamaha dealer to make adjustment

Front wheel removal

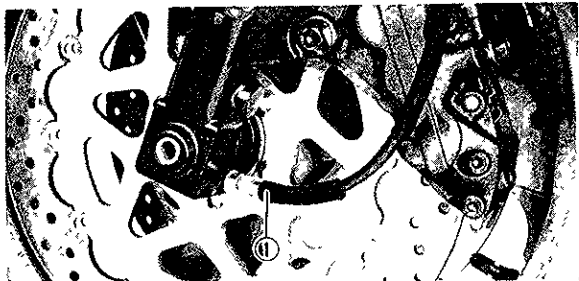

1 Speedometer cable

⚠ WARNING

It is advisable to have a Yamaha dealer service the wheel.

⚠ WARNING

Securely support the motorcycle so there is no danger of it falling over.

1. Remove the lower cowl.
2. Remove the speedometer cable from the front wheel side.



1 Wheel axle

2 Pinch bolt

3. Loosen the pinch bolt, wheel axle and caliper bolts.
4. Elevate the front wheel by placing a suitable stand under the engine.
5. Remove the brake hose holders and calipers.

NOTE:

Do not depress the brake lever when the caliper is off the disc as the brake pads will be forced shut.

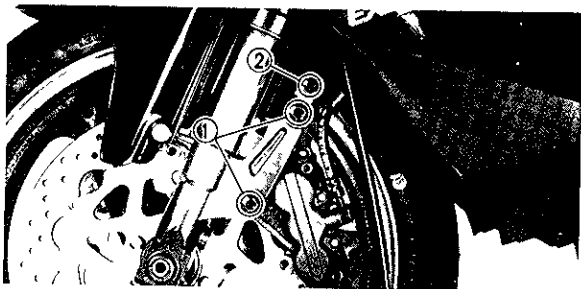

1 Caliper bolts

2 Brake hose holder

NOTE:

The circlip does not need to be removed from the front wheel axle to remove the front wheel.

- 6 Remove the axle. Make sure the motorcycle is properly supported.

Front wheel installation

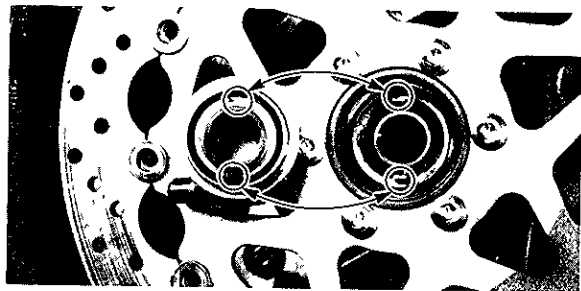

When installing the front wheel, reverse the removal procedure.

Pay attention to the following points:

1. Make sure the wheel hub and the speedometer clutch assembly are installed with the projections meshed into the slots.
2. Make sure there is enough gap between the brake pads before setting the caliper(s) or disc(s).
3. Make sure the slot in the speedometer gear unit fits over the stopper on the front fork.

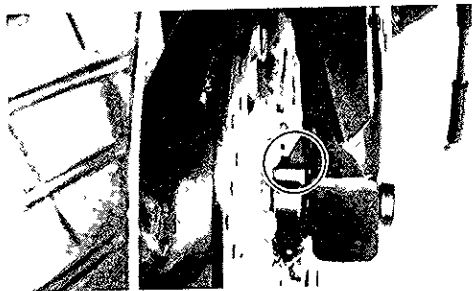

4. Make sure the following parts are properly torqued.

Tightening torque:

Axle:

72 Nm (7.2 m·kg, 52 ft·lb)

Caliper bolt:

35 Nm (3.5 m·kg, 25 ft·lb)

6. Tighten the pinch bolt.

Tightening torque:

Pinch bolt:

23 Nm (2.3 m·kg, 17 ft·lb)

5. Before tightening the pinch bolt, stroke the front fork several times to check for proper fork operation.

Rear wheel removal

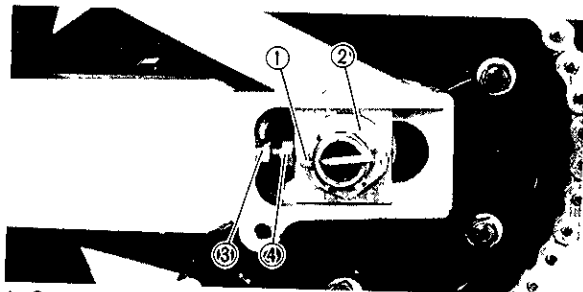

1 Cotter pin
4 Adjuster

2 Axle nut

3 Lock nut

⚠ WARNING

It is advisable to have a Yamaha dealer service the wheel.

⚠ WARNING

Securely support the motorcycle so there is no danger of it falling over.

- 1 Remove the lower cowl.
- 2 Remove the axle nut cotter pin and then loosen the axle nut.

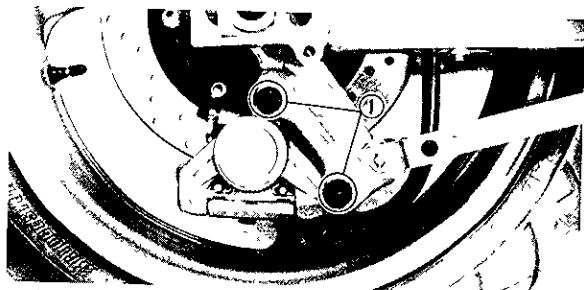

1 Caliper bolts

- 3 Elevate the rear wheel by placing a suitable stand under the engine.
- 4 Remove the axle nut.
- 5 Remove the caliper bolts and caliper.
- 6 Loosen both chain adjuster locknuts and adjusters.

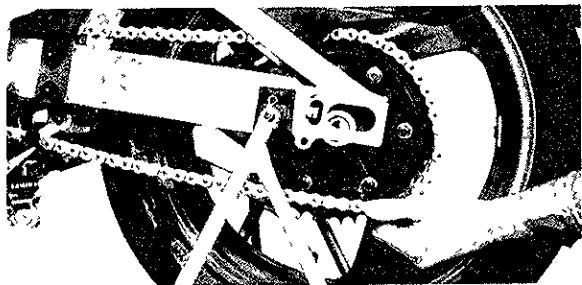

7. Push the wheel forward and remove the drive chain.

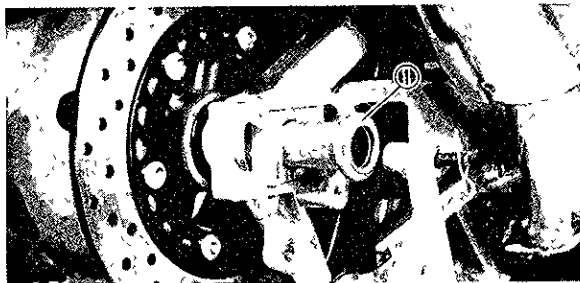

1 Wheel axle

8. Pull out the wheel axle and remove the wheel by pulling backward.

NOTE: _____

Do not depress the brake pedal when the disc and caliper are separated.

NOTE: _____

You do not have to disassemble the chain in order to remove or install the rear wheel.

CLEANING AND STORAGE

A. CLEANING

Frequent, thorough cleaning of your motorcycle will not only enhance its appearance but will improve its general performance and extend the useful life of many components.

1. Before cleaning the motorcycle:
 - a. Block off the end of the exhaust pipe to prevent water entry; a plastic bag and strong rubber band may be used
 - b. Make sure the spark plug(s) and all filler caps are properly installed.
2. If the engine case is excessively greasy, apply degreaser with a paint brush. Do not apply degreaser to the chain, sprockets, or wheel axles
3. Rinse the dirt and degreaser off with a garden hose. Use only enough pressure to do the job

CAUTION:

Excessive hose pressure may cause water seepage and deterioration of wheel bearings, front fork, brakes transmission seals and electrical parts.

Many expensive repair bills have resulted from improper high pressure detergent applications such as those available in coin-operated car washers.

4. Once the majority of the dirt has been hosed off, wash all surfaces with warm water and mild, detergent-type soap. An old toothbrush or bottle brush is handy for hard-to-get-at places.
5. Rinse the motorcycle off immediately with clean water and dry all surfaces with a chamois, clean towel, or soft absorbent cloth.
6. Dry the chain and lubricate it to prevent rust.

7. Windscreen cleaning

CAUTION: _____

Avoid using any alkaline or strong acid cleaner, gasoline, brake fluid, or any other solvent.

Clean the windscreen with a cloth or sponge dampened with a neutral detergent, and after cleaning, thoroughly wash it off with water. Some cleaning compounds for plastics may leave scratches on surfaces of the windscreen. Before using them, make a test by polishing an area which does not affect your visibility.

8. Clean the seat with a vinyl upholstery cleaner to keep the cover pliable and glossy.

- 9 Automotive-type wax may be applied to all painted and chrome-plated surfaces. Avoid combination cleaner-waxes. Many contain abrasives which may mar the paint or protective finish on the fuel tank and side covers. When finished, start the engine and let it idle for several minutes.

B. STORAGE

Long term storage (60 days or more) of your motorcycle will require some preventive procedures to guard against deterioration. After thoroughly cleaning the motorcycle, prepare for storage as follows.

1. Drain the fuel tank, fuel lines, and carburetor float bowl(s).
2. Remove the empty fuel tank, pour a cup of SAE 10W30 or 20W40 motor oil in the tank, shake the tank to coat the inner surfaces thoroughly and drain off the excess oil. Reinstall the tank.
3. Remove the spark plug, pour about one tablespoon of SAE 10W30 or 20W40 motor oil in the spark plug hole and reinstall the spark plug. Turn the engine over several times (ground spark plug lead wires) to coat the cylinder walls with oil.
4. Remove the drive chain. Thoroughly clean the chain with kerosene and lubricate it. Reinstall the chain or store it in a plastic bag (tied to frame for safe-keeping).
5. Lubricate all control cables
6. Block up the frame to raise both wheels off the ground.
7. Tie a plastic bag over the exhaust pipe outlet to prevent moisture from entering.
8. If storing in a humid or salt-air atmosphere, coat all exposed metal surfaces with a light film of oil. Do not apply oil to any rubber parts or the seat cover.

WARNING

When using the starter motor to crank the engine, remove the spark plug wires, and ground them to prevent sparking.

9. Remove the battery and charge it. Store it in a dry place and recharge it once a month. Do not store the battery in an excessively warm or cold place (less than 0°C (30°F) or more than 30°C (90°F)).

NOTE: _____
Make any necessary repairs before storing the motorcycle.

SPECIFICATIONS

Model	YZF750RF
Dimensions Overall length Overall width Overall height Seat height Wheelbase Minimum ground clearance Minimum turning radius	2,070 mm (81.5 in) 730 mm (28.7 in) 1,165 mm (45.9 in) 785 mm (30.9 in) 1,420 mm (55.9 in) 140 mm (5.51 in) 3,200 mm (126.0 in)
Basic weight With oil and full fuel tank	218 kg (481 lb)
Engine Engine type Model Cylinder arrangement Displacement Bore × stroke Compression ratio Starting system	Liquid-cooled 4-stroke, DOHC 4HA2 Forward-inclined parallel 4-cylinder 749 cm ³ 72 × 46 mm (2.83 × 1.81 in) 11.5:1 Electric starter
Lubrication system	Wet sump

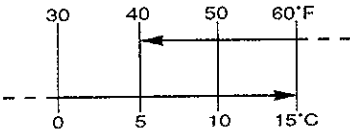
Model	YZF750RF
<p>Oil type or grade Engine oil</p> 	<p>SAE20W40 type SE motor oil (If temperature does not go below 5°C/40°F)</p> <p>SAE10W30 type SE motor oil (If temperature does not go above 15°C/60°F)</p>
<p>Oil capacity Engine oil</p> <p>Periodic oil change</p> <p>With oil filter replacement</p> <p>Total amount</p>	<p>3 L (2.6 Imp qt, 3.2 US qt)</p> <p>3.2 L (2.8 Imp qt, 3.4 US qt)</p> <p>4 L (3.5 Imp qt, 4.2 US qt)</p>
<p>Radiator capacity (including all routes)</p>	<p>2.4 L (2.11 Imp qt, 2.54 US qt)</p>
<p>Air filter</p>	<p>Dry type element</p>
<p>Fuel</p> <p>Type</p> <p>Fuel tank capacity</p> <p>Fuel reserve amount</p>	<p>Regular unleaded gasoline</p> <p>19 L (4.18 Imp gal, 5.02 US gal)</p> <p>3.5 L (0.77 Imp gal, 0.92 US gal)</p>
<p>Carburetor</p> <p>Type / quantity</p> <p>Manufacturer</p>	<p>BDST38/4</p> <p>MIKUNI</p>

Model	YZF750RF						
Spark plug Type Manufacturer Spark plug gap	CR8E, CR9E/U24ESR-N, U27ESR-N NGK/NIPPONDENSO 0.7 ~ 0.8 mm (0.028 ~ 0.031 in)						
Clutch type	Wet, multiple-disc						
Transmission Primary reduction system Primary reduction ratio Secondary reduction system Secondary reduction ratio Transmission type Operation Gear ratio <table data-bbox="571 569 728 777"> <tr><td>1st</td></tr> <tr><td>2nd</td></tr> <tr><td>3rd</td></tr> <tr><td>4th</td></tr> <tr><td>5th</td></tr> <tr><td>6th</td></tr> </table>	1st	2nd	3rd	4th	5th	6th	Spur gear 91/48(1.896) Chain drive 43/16(2.688) Constant mesh 6-speed Left foot operation 36/14(2.571) 33/17(1.941) 28/18(1.556) 26/19(1.368) 28/23(1.217) 26/24(1.083)
1st							
2nd							
3rd							
4th							
5th							
6th							
Chassis. Frame type Caster angle Trail	Diamond 24° 108 mm (4.25 in)						

Model	YZF750RF
Tire Type Size front rear	Tubeless 120/70 ZR17 180/55 ZR17
Brake: Front brake Rear brake type operation type operation	Dual disc brake Right hand operation Single disc brake Right foot operation
Suspension Front suspension Rear suspension	Telescopic fork Swingarm (link suspension)
Shock absorber. Front shock absorber Rear shock absorber	Coil spring / Oil damper Coil-gas spring / Oil damper
Wheel travel Front wheel travel Rear wheel travel	120 mm (4.7 in) 130 mm (5.1 in)

Model	YZF750RF
Electrical Ignition system Generator system Battery type Battery capacity	T C I (Digital) A C generator YTX12-BS/GTX12-BS 12 V 10 AH
Headlight type	Quartz bulb (Halogen)
Bulb wattage × quantity Headlight License light Tail / brake light Flasher light Meter light Indicator light NEUTRAL HIGH BEAM OIL LEVEL TURN FUEL	12 V 35 W / 35 W × 2 12 V 5 W × 2 12 V 5 W / 21 W × 2 12 V 21 W × 4 12 V 1.7 W × 4 12 V 3.4 W × 1 12 V 3.4 W × 1 12 V 3.4 W × 1 12 V 3.4 W × 1 12 V 3.4 W × 1

NOISE REGULATION (FOR Australia)

"TAMPERING WITH NOISE CONTROL SYSTEM PROHIBITED"

Owners are warned that the law may prohibit:

- (a) The removal or rendering inoperative by any person other than for purposes of maintenance, repair or replacement, of any device or element of design incorporated into any new vehicle for the purpose of noise control prior to its sale or delivery to the ultimate purchaser or while it is in use, and
- (b) the use of the vehicle after such device or element of design has been removed or rendered inoperative by any person.

YAMAHA MOTOR CO.,LTD.

PRINTED ON RECYCLED PAPER

PRINTED IN JAPAN
93 12 - 03 × 1 CR
(英)

YZF750R WIRING DIAGRAM

COLOR CODE

B	Black
Br	Brown
Ch	Chocolate
Dg	Dark green
G	Green
Gy	Gray
L	Blue
O	Orange
P	Pink
R	Red
Sb	Sky blue
W	White
Y	Yellow
B/L	Black/Blue
B/R	Black/Red
B/W	Black/White
B/Y	Black/Yellow
Br/W	Brown/White
G/R	Green/Red
G/Y	Green/Yellow
GW	Green/White
L/R	Blue/Red
L/W	Blue/White
L/Y	Blue/Yellow
RAW	Red/White
W/L	White/Blue
W/R	White/Red

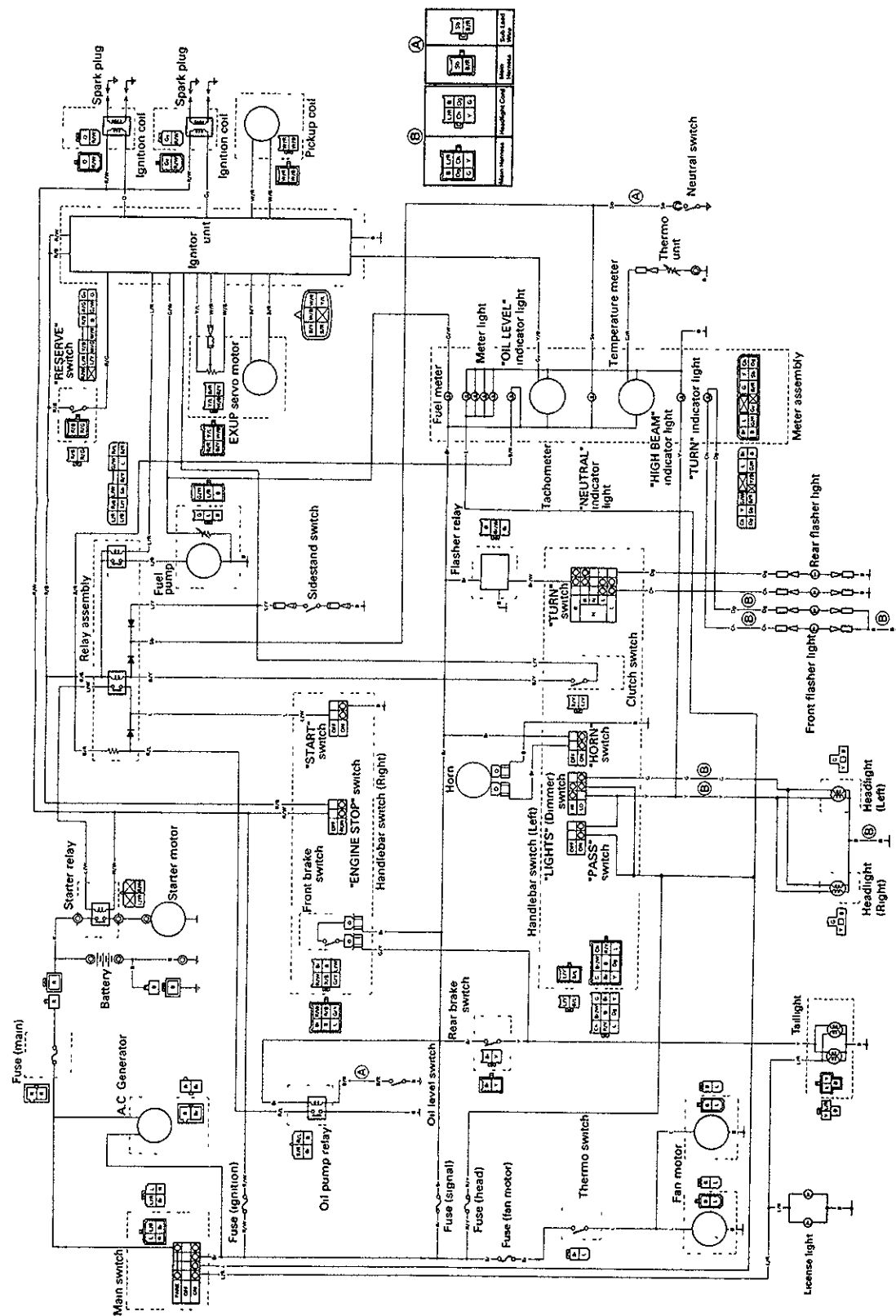

(A)

1	2	3	4	5	6	7	8	9	10
1	2	3	4	5	6	7	8	9	10

(B)

1	2	3	4	5	6	7	8	9	10
1	2	3	4	5	6	7	8	9	10

(C)

1	2	3	4	5	6	7	8	9	10
1	2	3	4	5	6	7	8	9	10