



OWNER'S MANUAL



XVS650V
XVS650AV

3B7-28199-20

Welcome to the Yamaha world of motorcycling!

As the owner of the XVS650/XVS650A, you are benefiting from Yamaha's vast experience and newest technology regarding the design and manufacture of high-quality products, which have earned Yamaha a reputation for dependability.

Please take the time to read this manual thoroughly, so as to enjoy all advantages of your XVS650/XVS650A. The owner's manual does not only instruct you in how to operate, inspect and maintain your motorcycle, but also in how to safeguard yourself and others from trouble and injury.



In addition, the many tips given in this manual will help keep your motorcycle in the best possible condition. If you have any further questions, do not hesitate to contact your Yamaha dealer.

The Yamaha team wishes you many safe and pleasant rides. So, remember to put safety first!

IMPORTANT MANUAL INFORMATION

EAU10150

Particularly important information is distinguished in this manual by the following notations:

	The Safety Alert Symbol means ATTENTION! BECOME ALERT! YOUR SAFETY IS INVOLVED!
	Failure to follow WARNING instructions could result in severe injury or death to the motorcycle operator, a bystander, or a person inspecting or repairing the motorcycle.
CAUTION:	A CAUTION indicates special precautions that must be taken to avoid damage to the motorcycle.
NOTE:	A NOTE provides key information to make procedures easier or clearer.

NOTE:

- This manual should be considered a permanent part of this motorcycle and should remain with it even if the motorcycle is subsequently sold.
- Yamaha continually seeks advancements in product design and quality. Therefore, while this manual contains the most current product information available at the time of printing, there may be minor discrepancies between your motorcycle and this manual. If you have any questions concerning this manual, please consult your Yamaha dealer.

EWA10030



PLEASE READ THIS MANUAL CAREFULLY AND COMPLETELY BEFORE OPERATING THIS MOTORCYCLE.

IMPORTANT MANUAL INFORMATION

EAU10200

**XVS650V/XVS650AV
OWNER'S MANUAL
©2005 by Yamaha Motor Co., Ltd.
1st edition, April 2005
All rights reserved.
Any reprinting or unauthorized use
without the written permission of
Yamaha Motor Co., Ltd.
is expressly prohibited.
Printed in Japan.**

TABLE OF CONTENTS

SAFETY INFORMATION	1-1	Adjusting the shock absorber assembly	3-15	Adjusting the engine idling speed	6-13
Location of important labels	1-5	Luggage strap holders	3-16	Checking the throttle cable free play	6-14
DESCRIPTION	2-1	Sidestand	3-16	Valve clearance	6-14
Left view	2-1	Ignition circuit cut-off system	3-17	Tires	6-14
Right view	2-2	PRE-OPERATION CHECKS	4-1	Spoke wheels	6-17
Controls and instruments.....	2-3	Pre-operation check list	4-2	Adjusting the clutch lever free play	6-17
INSTRUMENT AND CONTROL		OPERATION AND IMPORTANT		Adjusting the brake lever free play	6-18
FUNCTIONS	3-1	RIDING POINTS	5-1	Adjusting the brake pedal position and free play	6-19
Immobilizer system (XVS650A)	3-1	Starting and warming up a cold engine	5-1	Adjusting the rear brake light switch	6-20
Main switch/steering lock (XVS650).....	3-2	Starting a warm engine	5-2	Checking the front brake pads and rear brake shoes	6-21
Main switch/steering lock (XVS650A)	3-2	Shifting	5-3	Checking the front brake fluid level	6-21
Indicator and warning lights	3-4	Tips for reducing fuel consumption	5-4	Changing the brake fluid	6-22
Speedometer unit	3-5	Engine break-in	5-4	Checking and lubricating the cables	6-23
Handlebar switches	3-5	Parking	5-5	Checking and lubricating the throttle grip and cable	6-23
Clutch lever	3-7	PERIODIC MAINTENANCE AND		Checking and lubricating the brake and shift pedals	6-23
Shift pedal (XVS650).....	3-7	MINOR REPAIR	6-1	Checking and lubricating the brake and clutch levers	6-24
Shift pedal (XVS650A).....	3-7	Owner's tool kit	6-1	Checking and lubricating the sidestand	6-25
Brake lever	3-8	Periodic maintenance and lubrication chart	6-2	Checking the front fork	6-25
Brake pedal	3-8	Removing and installing panels	6-5		
Fuel tank cap	3-8	Checking the spark plugs	6-6		
Fuel	3-9	Engine oil and oil filter element	6-7		
Fuel cock	3-10	Final gear oil	6-10		
Starter (choke) knob.....	3-11	Cleaning the air filter element	6-11		
Seats (XVS650).....	3-11	Adjusting the carburetors	6-13		
Seats (XVS650A)	3-12				
Helmet holder	3-14				
Storage compartment	3-14				

TABLE OF CONTENTS

Checking the steering	6-26
Checking the wheel bearings	6-26
Battery	6-27
Replacing the fuses	6-28
Replacing the headlight bulb	6-29
Replacing a turn signal light bulb or the tail/brake light bulb	6-30
Replacing the auxiliary light bulb (XVS650A)	6-31
Supporting the motorcycle	6-32
Front wheel	6-32
Rear wheel	6-34
Troubleshooting	6-35
Troubleshooting chart	6-36

MOTORCYCLE CARE AND

STORAGE	7-1
Care	7-1
Storage	7-3

SPECIFICATIONS	8-1
-----------------------------	-----

CONSUMER INFORMATION	9-1
Identification numbers	9-1
Motorcycle noise regulation (for Australia)	9-2

SAFETY INFORMATION

EAU10251

1

MOTORCYCLES ARE SINGLE TRACK VEHICLES. THEIR SAFE USE AND OPERATION ARE DEPENDENT UPON THE USE OF PROPER RIDING TECHNIQUES AS WELL AS THE EXPERTISE OF THE OPERATOR. EVERY OPERATOR SHOULD KNOW THE FOLLOWING REQUIREMENTS BEFORE RIDING THIS MOTORCYCLE.

HE OR SHE SHOULD:

- OBTAIN THOROUGH INSTRUCTIONS FROM A COMPETENT SOURCE ON ALL ASPECTS OF MOTORCYCLE OPERATION.
- OBSERVE THE WARNINGS AND MAINTENANCE REQUIREMENTS IN THE OWNER'S MANUAL.
- OBTAIN QUALIFIED TRAINING IN SAFE AND PROPER RIDING TECHNIQUES.
- OBTAIN PROFESSIONAL TECHNICAL SERVICE AS INDICATED BY THE OWNER'S MANUAL

AND/OR WHEN MADE NECESSARY BY MECHANICAL CONDITIONS.

Safe riding

- Always make pre-operation checks. Careful checks may help prevent an accident.
- This motorcycle is designed to carry the operator and a passenger.
- The failure of motorists to detect and recognize motorcycles in traffic is the predominating cause of automobile/motorcycle accidents. Many accidents have been caused by an automobile driver who did not see the motorcycle. Making yourself conspicuous appears to be very effective in reducing the chance of this type of accident.

Therefore:

- Wear a brightly colored jacket.
- Use extra caution when approaching and passing through intersections, since intersections are the most likely places for motorcycle accidents to occur.

- Ride where other motorists can see you. Avoid riding in another motorist's blind spot.
- Many motorcycle accidents involve inexperienced operators. In fact, many operators who have been involved in accidents do not even have a current motorcycle license.
- Make sure that you are qualified and that you only lend your motorcycle to other qualified operators.
- Know your skills and limits. Staying within your limits may help you to avoid an accident.
- We recommend that you practice riding your motorcycle where there is no traffic until you have become thoroughly familiar with the motorcycle and all of its controls.
- Many motorcycle accidents have been caused by error of the motorcycle operator. A typical error made by the operator is veering

wide on a turn due to **EXCESSIVE SPEED** or undercornering (insufficient lean angle for the speed).

- Always obey the speed limit and never travel faster than warranted by road and traffic conditions.
- Always signal before turning or changing lanes. Make sure that other motorists can see you.
- The posture of the operator and passenger is important for proper control.
 - The operator should keep both hands on the handlebar and both feet on the operator footrests during operation to maintain control of the motorcycle.
 - The passenger should always hold onto the operator, seat strap, or grab bar, if equipped, with both hands and keep both feet on the passenger footrests.
 - Never carry a passenger unless he or she can firmly place both feet on the passenger footrests.
- Never ride under the influence of alcohol or other drugs.

- This motorcycle is designed for on-road use only, therefore, it is not suitable for off-road use.

Protective apparel

The majority of fatalities from motorcycle accidents are the result of head injuries. The use of a safety helmet is the single most critical factor in the prevention or reduction of head injuries.

- Always wear an approved helmet.
- Wear a face shield or goggles. Wind in your unprotected eyes could contribute to an impairment of vision which could delay seeing a hazard.
- The use of a jacket, heavy boots, trousers, gloves, etc., is effective in preventing or reducing abrasions or lacerations.
- Never wear loose-fitting clothes, otherwise they could catch on the control levers, footrests, or wheels and cause injury or an accident.
- Never touch the engine or exhaust system during or after operation. They become very hot and can

cause burns. Always wear protective clothing that covers your legs, ankles, and feet.

- Passengers should also observe the precautions mentioned above.

Modifications

Modifications made to this motorcycle not approved by Yamaha, or the removal of original equipment, may render the motorcycle unsafe for use and may cause severe personal injury. Modifications may also make your motorcycle illegal to use.

Loading and accessories

Adding accessories or cargo to your motorcycle can adversely affect stability and handling if the weight distribution of the motorcycle is changed. To avoid the possibility of an accident, use extreme caution when adding cargo or accessories to your motorcycle. Use extra care when riding a motorcycle that has added cargo or accessories. Here are some general guidelines to follow if loading cargo or adding accessories to your motorcycle:

SAFETY INFORMATION

Loading

The total weight of the operator, passenger, accessories and cargo must not exceed the maximum load limit.

Maximum load:

XVS650 180 kg (397 lb)
XVS650A 200 kg (441 lb)

When loading within this weight limit, keep the following in mind:

- Cargo and accessory weight should be kept as low and close to the motorcycle as possible. Make sure to distribute the weight as evenly as possible on both sides of the motorcycle to minimize imbalance or instability.
- Shifting weights can create a sudden imbalance. Make sure that accessories and cargo are securely attached to the motorcycle before riding. Check accessory mounts and cargo restraints frequently.
- Never attach any large or heavy items to the handlebar, front fork, or front fender. These items, including such cargo as sleeping

bags, duffel bags, or tents, can create unstable handling or slow steering response.

Accessories

Genuine Yamaha accessories have been specifically designed for use on this motorcycle. Since Yamaha cannot test all other accessories that may be available, you must personally be responsible for the proper selection, installation and use of non-Yamaha accessories. Use extreme caution when selecting and installing any accessories.

Keep the following guidelines in mind, as well as those provided under “Loading” when mounting accessories.

- Never install accessories or carry cargo that would impair the performance of your motorcycle. Carefully inspect the accessory before using it to make sure that it does not in any way reduce ground clearance or cornering clearance,

limit suspension travel, steering travel or control operation, or obscure lights or reflectors.

- Accessories fitted to the handlebar or the front fork area can create instability due to improper weight distribution or aerodynamic changes. If accessories are added to the handlebar or front fork area, they must be as lightweight as possible and should be kept to a minimum.
- Bulky or large accessories may seriously affect the stability of the motorcycle due to aerodynamic effects. Wind may attempt to lift the motorcycle, or the motorcycle may become unstable in cross winds. These accessories may also cause instability when passing or being passed by large vehicles.
- Certain accessories can displace the operator from his or her normal riding position. This improper position limits the freedom of movement of the opera-

tor and may limit control ability, therefore, such accessories are not recommended.

- Use caution when adding electrical accessories. If electrical accessories exceed the capacity of the motorcycle's electrical system, an electric failure could result, which could cause a dangerous loss of lights or engine power.

Gasoline and exhaust gas

- **GASOLINE IS HIGHLY FLAMMABLE:**
 - Always turn the engine off when refueling.
 - Take care not to spill any gasoline on the engine or exhaust system when refueling.
 - Never refuel while smoking or in the vicinity of an open flame.
- Never start the engine or let it run for any length of time in a closed area. The exhaust fumes are poisonous and may cause loss of consciousness and death within a short time. Always operate your motorcycle in an area that has adequate ventilation.

- Always turn the engine off before leaving the motorcycle unattended and remove the key from the main switch. When parking the motorcycle, note the following:
 - The engine and exhaust system may be hot, therefore, park the motorcycle in a place where pedestrians or children are not likely to touch these hot areas.
 - Do not park the motorcycle on a slope or soft ground, otherwise it may fall over.
 - Do not park the motorcycle near a flammable source (e.g. a kerosene heater, or near an open flame), otherwise it could catch fire.
- When transporting the motorcycle in another vehicle, make sure that it is kept upright and that the fuel cock is turned to "ON" or "RES" (for vacuum type) / "OFF" (for manual type). If it should lean over, gasoline may leak out of the carburetor or fuel tank.
- If you should swallow any gasoline, inhale a lot of gasoline vapor, or allow gasoline to get into your

eyes, see your doctor immediately. If any gasoline spills on your skin or clothing, immediately wash the affected area with soap and water and change your clothes.

SAFETY INFORMATION

EAU10381



Location of important labels

Please read the following important labels carefully before operating this vehicle.

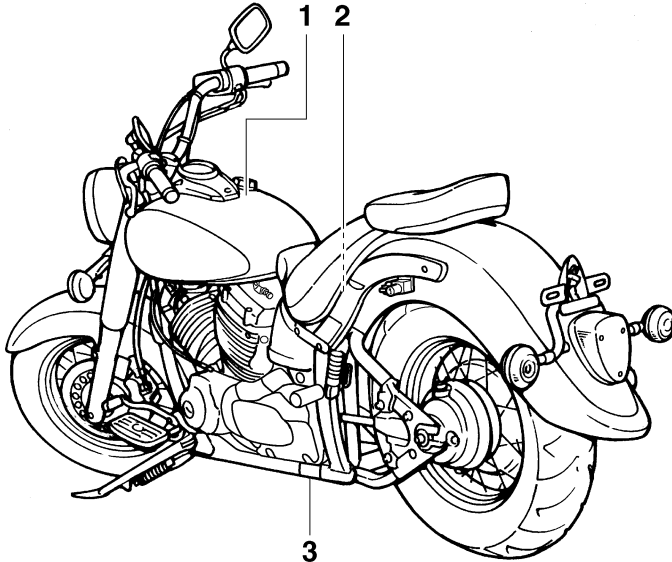
1



1

	<ul style="list-style-type: none">• Before you operate this vehicle, read the owner's manual.• Prima di usare il veicolo, leggete il manuale di istruzioni.• Lire le manuel du propriétaire avant d'utiliser ce véhicule.• Lesen Sie die Bedienungsanleitung bevor Sie dieses Fahrzeug fahren.• Antes de conducir este vehículo, lea el Manual del Propietario.
	

5RU-21568-00

2



3 XVS650

TIRE INFORMATION

Cold tire normal pressure should be set as follows.

- Up to 90 kg (198 lbs) load

FRONT : 200 kPa, {2.00 kgf/cm²}, 29 psi

REAR : 225 kPa, {2.25 kgf/cm²}, 33 psi

- 90 kg (198 lbs) ~ maximum load

FRONT : 200 kPa, {2.00 kgf/cm²}, 29 psi

REAR : 250 kPa, {2.50 kgf/cm²}, 36 psi

5FB-21668-01

3 XVS650A

TIRE INFORMATION

Cold tire normal pressure should be set as follows.

- Up to 90 kg (198 lbs) load

FRONT : 225 kPa, {2.25 kgf/cm²}, 33 psi

REAR : 225 kPa, {2.25 kgf/cm²}, 33 psi

- 90 kg (198 lbs) ~ maximum load

FRONT : 225 kPa, {2.25 kgf/cm²}, 33 psi

REAR : 250 kPa, {2.50 kgf/cm²}, 36 psi

5BN-21668-00

DESCRIPTION

EAU10410

Left view

2

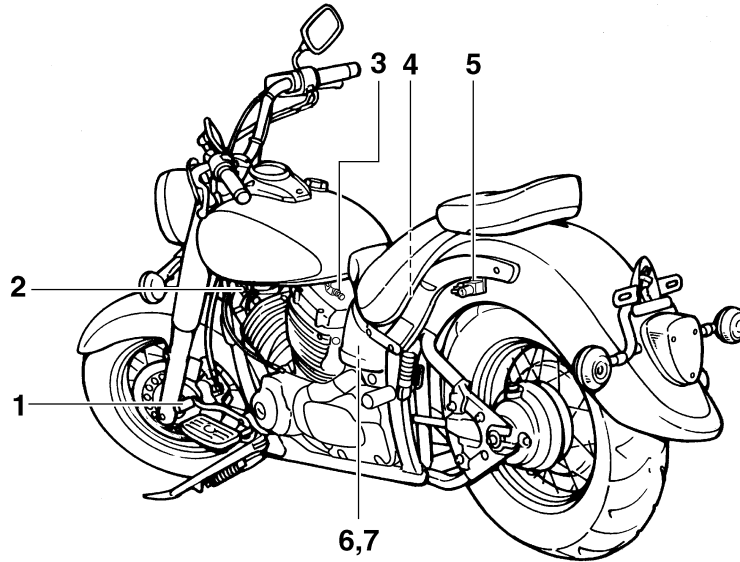

1. Shift pedal (page 3-7)
2. Fuel cock (page 3-10)
3. Starter (choke) knob (page 3-11)
4. Shock absorber assembly spring preload adjusting ring (page 3-15)
5. Helmet holder (page 3-14)
6. Storage compartment (page 3-14)
7. Owner's tool kit (page 6-1)

Right view

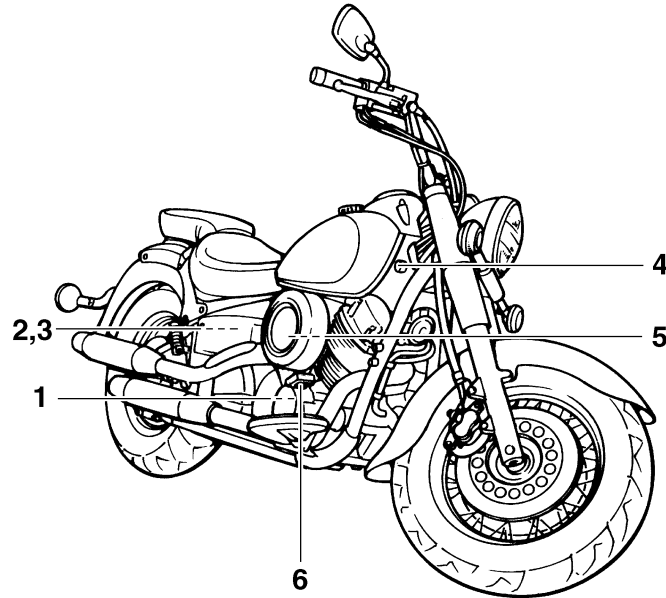

1. Engine oil filter element (page 6-7)
2. Battery (page 6-27)
3. Fuses (page 6-28)
4. Main switch/steering lock (page 3-2)
5. Air filter element (page 6-11)
6. Brake pedal (page 3-8)

DESCRIPTION

EAU10430

Controls and instruments

2

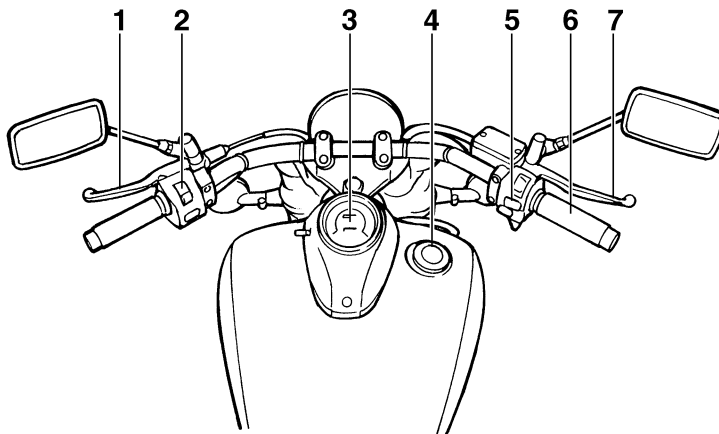

1. Clutch lever (page 3-7)
2. Left handlebar switches (page 3-5)
3. Speedometer unit (page 3-5)
4. Fuel tank cap (page 3-8)
5. Right handlebar switches (page 3-5)
6. Throttle grip (page 6-14)
7. Brake lever (page 3-8)

Immobilizer system (XVS650A)

EAU26890

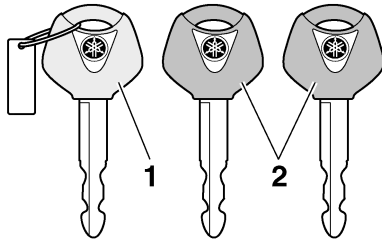

1. Code re-registering key (red bow)
2. Standard keys (black bow)

This vehicle is equipped with an immobilizer system to help prevent theft by re-registering codes in the standard keys. This system consists of the following.

- a code re-registering key (with a red bow)
- two standard keys (with a black bow) that can be re-registered with new codes
- a transponder (which is installed in the code re-registering key)
- an immobilizer unit
- the ignitor unit

- an immobilizer system indicator light (See page 3-4.)
- The key with the red bow is used to register codes in each standard key. Since re-registering is a difficult process, take the vehicle along with all three keys to a Yamaha dealer to have them re-registered. Do not use the key with the red bow for driving. It should only be used for re-registering the standard keys. Always use a standard key for driving.

ECA11820

CAUTION:

- **DO NOT LOSE THE CODE RE-REGISTERING KEY! CONTACT YOUR DEALER IMMEDIATELY IF IT IS LOST! If the code re-registering key is lost, registering new codes in the standard keys is impossible. The standard keys can still be used to start the vehicle, however if code re-registering is required (i.e., if a new standard key is made or all keys are lost) the entire immobilizer system must be replaced. Therefore, it is highly recom-**

mended to use either standard key and keep the code re-registering key in a safe place.

- Do not submerge any key in water.
- Do not expose any key to excessively high temperatures.
- Do not place any key close to magnets (this includes, but not limited to, products such as speakers, etc.).
- Do not place heavy items on any key.
- Do not grind any key or alter its shape.
- Do not disassemble the plastic part of any key.
- Do not put two keys of any immobilizer system on the same key ring.
- Keep the standard keys as well as keys of other immobilizer systems away from this vehicle's code re-registering key.
- Keep other immobilizer system keys away from the main switch as they may cause signal interference.

INSTRUMENT AND CONTROL FUNCTIONS

3

Main switch/steering lock (XVS650)

EAU10460

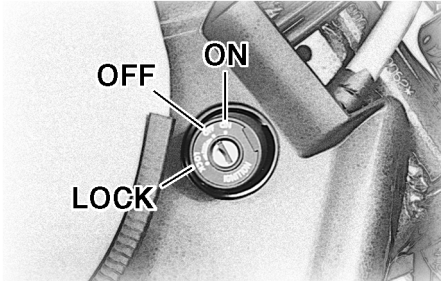

The main switch/steering lock controls the ignition and lighting systems, and is used to lock the steering. The various positions are described below.

Main switch/steering lock (XVS650A)

EAU10471

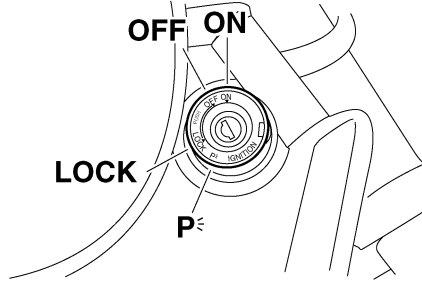

The main switch/steering lock controls the ignition and lighting systems, and is used to lock the steering.

NOTE: _____
Be sure to use the standard key (black bow) for regular use of the vehicle. To minimize the risk of losing the code re-registering key (red bow), keep it in a safe place and only use it for code re-registering.

ON (XVS650)

EAU10480

All electrical systems are supplied with power, and the headlight, meter lighting and taillight come on, and the engine can be started. The key cannot be removed.

ON (XVS650A)

EAU33590

All electrical circuits are supplied with power; the meter lighting, taillight and auxiliary light come on, and the engine can be started. The key cannot be removed.

NOTE: _____
The headlight comes on automatically when the engine is started and stays on until the key is turned to "OFF", even if the engine stalls.

OFF

EAU10660

All electrical systems are off. The key can be removed.

INSTRUMENT AND CONTROL FUNCTIONS

LOCK

The steering is locked, and all electrical systems are off. The key can be removed.

To lock the steering

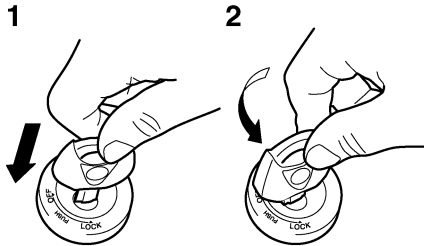

1. Push.
 2. Turn.
1. Turn the handlebars all the way to the left.
 2. Push the key in from the "OFF" position, and then turn it to "LOCK" while still pushing it.
 3. Remove the key.

EAU10680

To unlock the steering

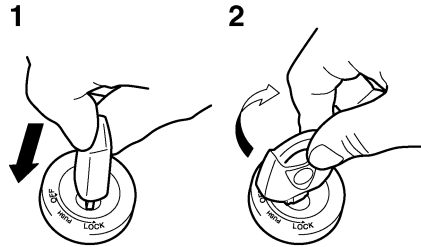

1. Push.
2. Turn.

Push the key in, and then turn it to "OFF" while still pushing it.

EWA10060

⚠ WARNING

Never turn the key to "OFF" or "LOCK" while the vehicle is moving, otherwise the electrical systems will be switched off, which may result in loss of control or an accident. Make sure that the vehicle is stopped before turning the key to "OFF" or "LOCK".

EAU33000

p< (Parking) (XVS650A)

The steering is locked, and the taillight and auxiliary light are on. The hazard light and turn signal lights can be turned on, but all other electrical systems are off. The key can be removed.

The steering must be locked before the key can be turned to "p<".

ECA11020

CAUTION:





Do not use the parking position for an extended length of time, otherwise the battery may discharge.

INSTRUMENT AND CONTROL FUNCTIONS

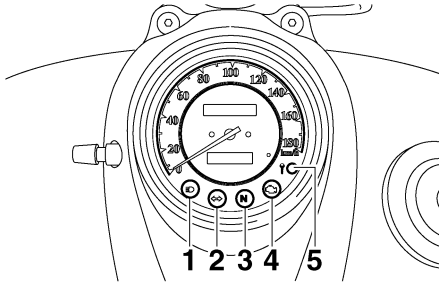
3

Indicator and warning lights ^{EAU11003}



1. High beam indicator light “”
2. Turn signal indicator light “”
3. Neutral indicator light “**N**”
4. Engine trouble warning light “”
5. Immobilizer system indicator light “” (for XVS650A only)

Turn signal indicator light “” ^{EAU11020}

This indicator light flashes when the turn signal switch is pushed to the left or right.

Neutral indicator light “**N**” ^{EAU11060}

This indicator light comes on when the transmission is in the neutral position.

High beam indicator light “” ^{EAU11080}

This indicator light comes on when the high beam of the headlight is switched on.

Engine trouble warning light “” ^{EAU11500}

This warning light comes on or flashes when an electrical circuit monitoring the engine is defective. When this occurs, have a Yamaha dealer check the self-diagnosis system.

The electrical circuit of the warning light can be checked by turning the key to “ON”. If the warning light does not come on for a few seconds, then go off, have a Yamaha dealer check the electrical circuit.

Immobilizer system indicator light “” (XVS650A) ^{EAU27020}

The electrical circuit of the indicator light can be checked by turning the key to “ON”.

If the indicator light does not come on for a few seconds, then go off, have a Yamaha dealer check the electrical circuit.

When the key is turned to “OFF” and 30 seconds have passed, the indicator light will start flashing indicating the immobilizer system is enabled. After 24 hours have passed, the indicator light will stop flashing, however the immobilizer system is still enabled.

NOTE: _____

This model is also equipped with a self-diagnosis device for the immobilizer system. If the immobilizer system is defective, the indicator light will start flashing a pattern when the key is turned to “ON”. When this occurs, have a Yamaha dealer check the self-diagnosis system. However, if the indicator light slowly flashes five times, and then quickly flashes two times repeatedly, this error could be caused by signal interference. If this occurs, try the following.

1. Use the code re-registering key to start the engine.

NOTE: _____

Make sure there are no other immobilizer keys close to the main switch, and do not keep more than one immobilizer

INSTRUMENT AND CONTROL FUNCTIONS

key on the same key ring! Immobilizer system keys may cause signal interference, which may prevent the engine from starting.

2. If the engine starts, turn it off, and try starting the engine with the standard keys.
3. If one or both of the standard keys do not start the engine, take the vehicle, the code re-registering key and both standard keys to a Yamaha dealer and have the standard keys re-registered.

Speedometer unit

EAU111630

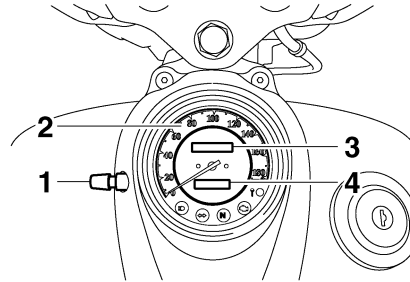

1. Tripmeter reset knob
2. Speedometer
3. Odometer
4. Tripmeter





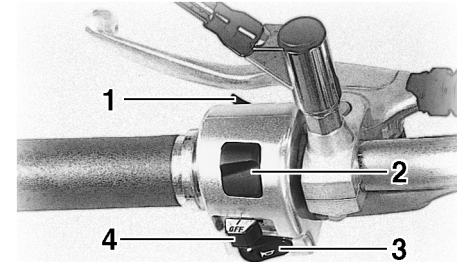

The speedometer unit is equipped with a speedometer, an odometer and a tripmeter. The speedometer shows riding speed. The odometer shows the total distance traveled. The tripmeter shows the distance traveled since it was last set to zero with the reset knob. The tripmeter can be used to estimate the distance that can be traveled with a full tank of fuel. This information will enable you to plan future fuel stops.

Handlebar switches

EAU12343



Left

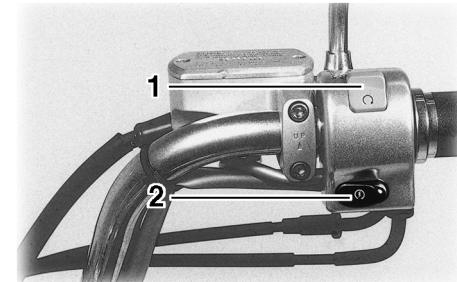

1. Pass switch “ ”
2. Dimmer switch “ /  ”
3. Horn switch “ ”
4. Turn signal switch “ /  ”

Right (XVS650)



1. Engine stop switch “ /  ”
2. Start switch “ ”

INSTRUMENT AND CONTROL FUNCTIONS

Right (XVS650A)

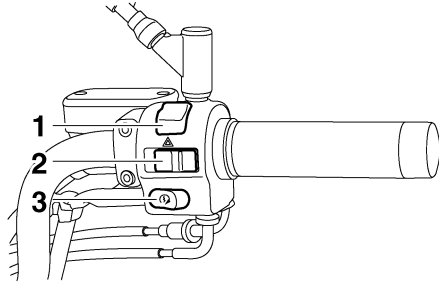

1. Engine stop switch “○/⊗”
2. Hazard switch “△”
3. Start switch “⊚”

EAU12350

Pass switch “≡”

Press this switch to flash the headlight.

EAU12400

Dimmer switch “≡/≡”

Set this switch to “≡” for the high beam and to “≡” for the low beam.

EAU12460

Turn signal switch “⇐/⇒”

To signal a right-hand turn, push this switch to “⇒”. To signal a left-hand turn, push this switch to “⇐”. When released, the switch returns to the center

position. To cancel the turn signal lights, push the switch in after it has returned to the center position.

EAU12500

Horn switch “📢”

Press this switch to sound the horn.

EAU12660

Engine stop switch “○/⊗”

Set this switch to “○” before starting the engine. Set this switch to “⊗” to stop the engine in case of an emergency, such as when the vehicle overturns or when the throttle cable is stuck.

EAU12710

Start switch “⊚”

Push this switch to crank the engine with the starter.

ECA10050

CAUTION:

See page 5-1 for starting instructions prior to starting the engine.

EAU12732

Hazard switch “△” (XVS650A)

With the key in the “ON” or “P” position, use this switch to turn on the hazard light (simultaneous flashing of all turn signal lights).

The hazard light is used in case of an emergency or to warn other drivers when your vehicle is stopped where it might be a traffic hazard.

ECA10061

CAUTION:

Do not use the hazard lights for an extended length of time with the engine not running, otherwise the battery may discharge.

INSTRUMENT AND CONTROL FUNCTIONS

Clutch lever

EAU12820

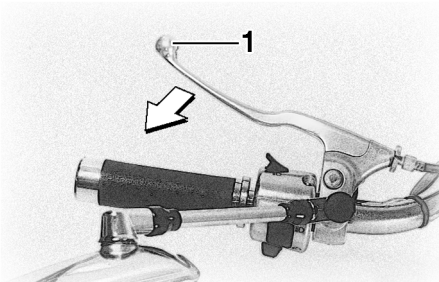

1. Clutch lever

The clutch lever is located at the left handlebar grip. To disengage the clutch, pull the lever toward the handlebar grip. To engage the clutch, release the lever. The lever should be pulled rapidly and released slowly for smooth clutch operation.

The clutch lever is equipped with a clutch switch, which is part of the ignition circuit cut-off system. (See page 3-17.)

Shift pedal (XVS650)

EAU12870

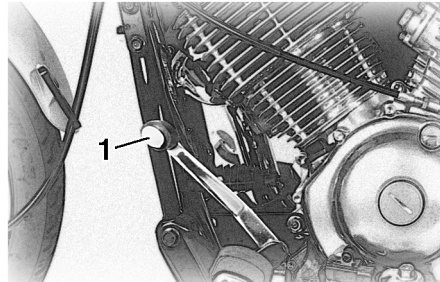

1. Shift pedal

The shift pedal is located on the left side of the engine and is used in combination with the clutch lever when shifting the gears of the 5-speed constant-mesh transmission equipped on this motorcycle.

Shift pedal (XVS650A)

EAU12880

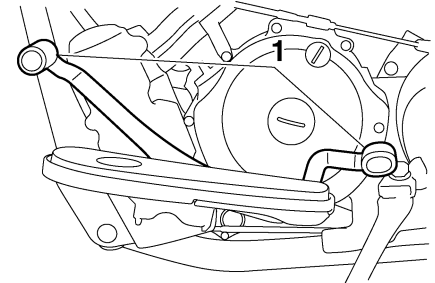

1. Shift pedal

The shift pedal is located on the left side of the engine and is used in combination with the clutch lever when shifting the gears of the 5-speed constant-mesh transmission equipped on this motorcycle.

NOTE: _____
Use your toes or heel to shift up and your toes to shift down.

INSTRUMENT AND CONTROL FUNCTIONS

Brake lever

EAU12890

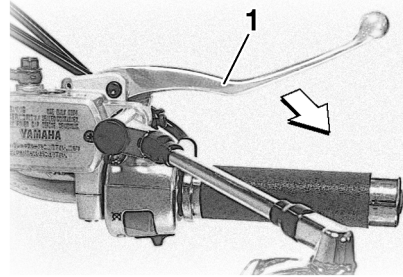

1. Brake lever

The brake lever is located at the right handlebar grip. To apply the front brake, pull the lever toward the handlebar grip.

Brake pedal

EAU12941

XVS650

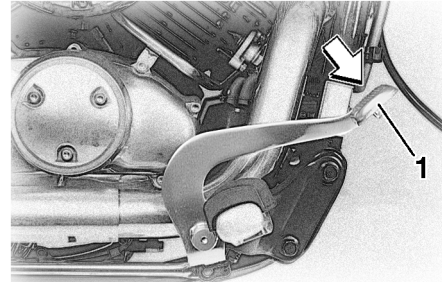

1. Brake pedal

XVS650A

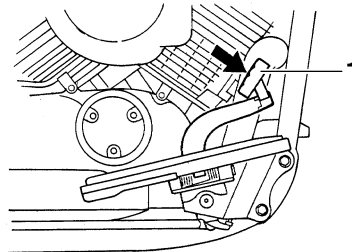

1. Brake pedal

The brake pedal is on the right side of the motorcycle. To apply the rear brake, press down on the brake pedal.

Fuel tank cap

EAU13120

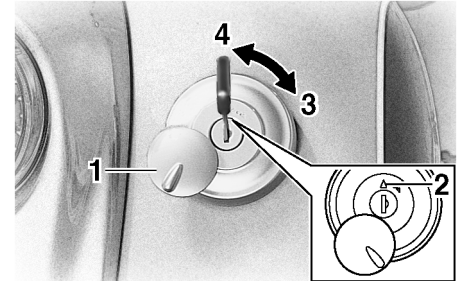

1. Fuel tank cap lock cover
2. “△” mark
3. Unlock.
4. Lock.

To remove the fuel tank cap

Slide the lock cover open, insert the key into the lock, and then turn it 1/4 turn clockwise. The lock will be released and the fuel tank cap can be removed.

To install the fuel tank cap

1. Insert the fuel tank cap into the tank opening with the key inserted in the lock and with the “△” mark facing forward.

INSTRUMENT AND CONTROL FUNCTIONS

2. Turn the key counterclockwise to the original position, remove it, and then close the lock cover.

NOTE: _____

The fuel tank cap cannot be installed unless the key is in the lock. In addition, the key cannot be removed if the cap is not properly installed and locked.

EWA10130

WARNING _____

Make sure that the fuel tank cap is properly installed before riding.

Fuel

EAU13210

ECA10070

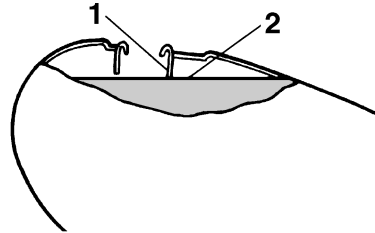

1. Fuel tank filler tube
2. Fuel level

Make sure that there is sufficient fuel in the tank. Fill the fuel tank to the bottom of the filler tube as shown.

EWA10880

WARNING _____

- Do not overfill the fuel tank, otherwise it may overflow when the fuel warms up and expands.
- Avoid spilling fuel on the hot engine.

CAUTION: _____

Immediately wipe off spilled fuel with a clean, dry, soft cloth, since fuel may deteriorate painted surfaces or plastic parts.

EAU13330

3

Recommended fuel:

UNLEADED GASOLINE ONLY

Fuel tank capacity:

16.0 L (4.23 US gal) (3.52 Imp.gal)

Fuel reserve amount:

3.0 L (0.79 US gal) (0.66 Imp.gal)

ECA11400

CAUTION: _____

Use only unleaded gasoline. The use of leaded gasoline will cause severe damage to internal engine parts, such as the valves and piston rings, as well as to the exhaust system.

Your Yamaha engine has been designed to use regular unleaded gasoline with a research octane number of 91 or higher. If knocking (or pinging) occurs, use a gasoline of a different brand

INSTRUMENT AND CONTROL FUNCTIONS

3

or premium unleaded fuel. Use of unleaded fuel will extend spark plug life and reduce maintenance costs.

Fuel cock

EAU13550

The fuel cock supplies fuel from the tank to the carburetors while also filtering it.

The fuel cock lever positions are explained as follows and shown in the illustrations.

OFF

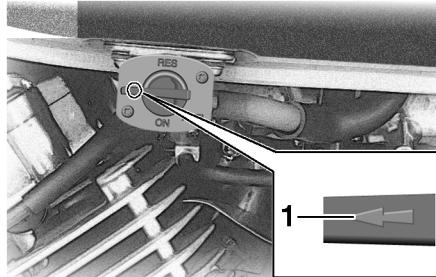

1. Arrow mark positioned over "OFF"

With the fuel cock lever in this position, fuel will not flow. Always turn the fuel cock lever to this position when the engine is not running.

ON

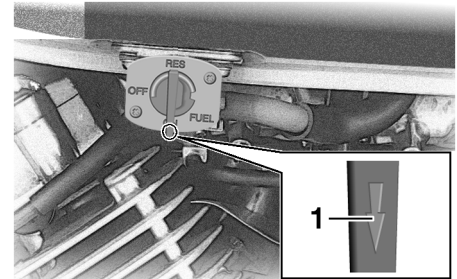

1. Arrow mark positioned over "ON"

With the fuel cock lever in this position, fuel flows to the carburetors. Turn the fuel cock lever to this position when starting the engine and riding.

RES

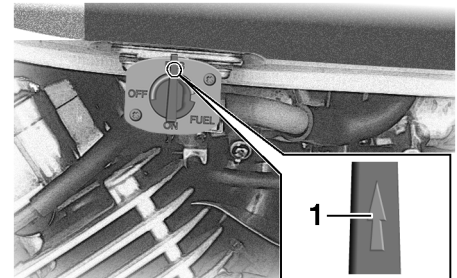

1. Arrow mark positioned over "RES"

This indicates reserve. With the fuel cock lever in this position, the fuel reserve is made available. Turn the fuel cock lever to this position if you run out of fuel while riding. When this occurs, refuel as soon as possible and be sure to turn the fuel cock lever back to “ON”!

Starter (choke) knob “”

EAU13620

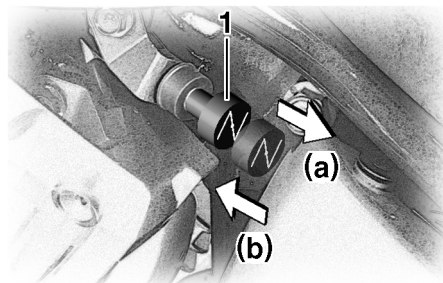

1. Starter (choke) knob “”

Starting a cold engine requires a richer air-fuel mixture, which is supplied by the starter (choke).

Move the knob in direction (a) to turn on the starter (choke).

Move the knob in direction (b) to turn off the starter (choke).

ECA10990

CAUTION:

Do not use the starter (choke) for more than 3 minutes as the exhaust pipe may discolor from excessive heat. In addition, extended use of the starter (choke) will cause after-burning. If this occurs, turn off the starter (choke).

Seats (XVS650)

EAU14183

Passenger seat

To remove the passenger seat
Remove the nut, and then pull the passenger seat up.

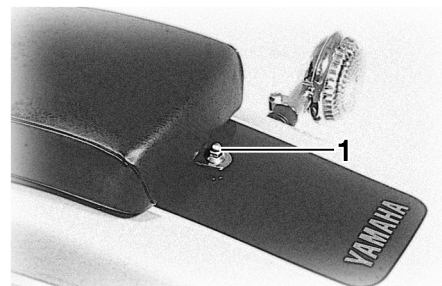

1. Nut

To install the passenger seat

1. Insert the projection on the front of the passenger seat into the seat holder as shown and place the seat in the original position.
2. Install the nut, and then tighten the nut to the specified torque.

INSTRUMENT AND CONTROL FUNCTIONS

EAU14191

Tightening torque:

Passenger seat nut:
7.0 Nm (0.7 m·kgf, 5.1 ft·lbf)

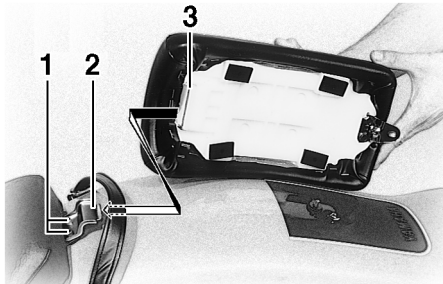

1. Bolt
2. Seat holder
3. Projection

Rider seat

To remove the rider seat

1. Remove the passenger seat.
2. Remove the passenger seat holder by removing its bolts, and then pull the rider seat up.

To install the rider seat

1. Insert the projection on the front of the rider seat into the seat holder as shown, and then place the seat in the original position.

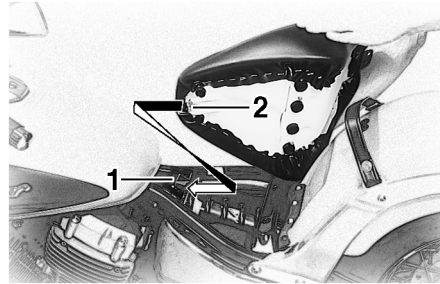

1. Seat holder
2. Projection
2. Install the passenger seat holder by installing its bolts.
3. Install the passenger seat.

NOTE:

Make sure that the seats are properly secured before riding.

Seats (XVS650A)

Passenger seat

To remove the passenger seat

Remove the nut and washer, and then pull the passenger seat up.



1. Nut
2. Washer

To install the passenger seat

1. Insert the projections on the front of the passenger seat into the holders as shown and place the seat in the original position.
2. Install the washer and nut, and then tighten the nut to the specified torque.

INSTRUMENT AND CONTROL FUNCTIONS

Tightening torque:

Passenger seat nut:
21 Nm (2.1 m·kgf, 15 ft·lbf)

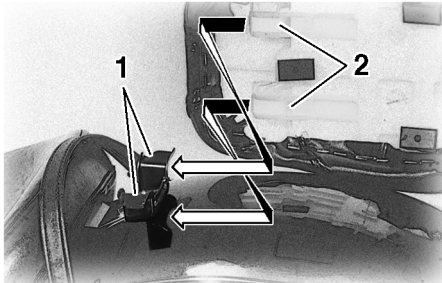

1. Seat holder
2. Projection

Rider seat

To remove the rider seat

1. Remove the passenger seat.
2. Remove the bolt, and then pull the rider seat up.

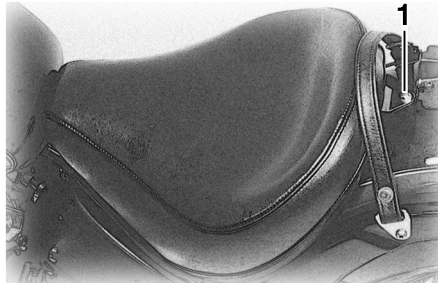

1. Bolt

To install the rider seat

1. Insert the projection on the front of the rider seat into the holder as shown, place the seat in the original position, and then install the bolt.

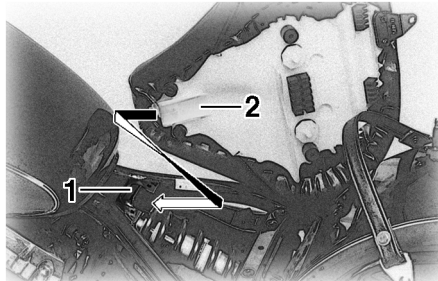

1. Seat holder
2. Projection

2. Install the passenger seat.

NOTE: _____
Make sure that the seats are properly secured before riding.

INSTRUMENT AND CONTROL FUNCTIONS

Helmet holder

EAU14281

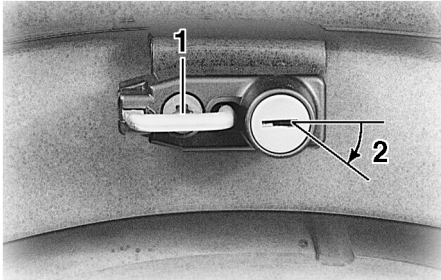

1. Helmet holder
2. Unlock.

To open the helmet holder, insert the key into the lock, and then turn the key as shown.

To lock the helmet holder, place it in the original position, and then remove the key.

⚠ WARNING

Never ride with a helmet attached to the helmet holder, since the helmet may hit objects, causing loss of control and possibly an accident.

EWA10160

Storage compartment

EAU14481

The storage compartment is located on the left side of the vehicle.

To open the storage compartment

1. Slide the lock cover open, insert the key into the lock, and then turn it clockwise.

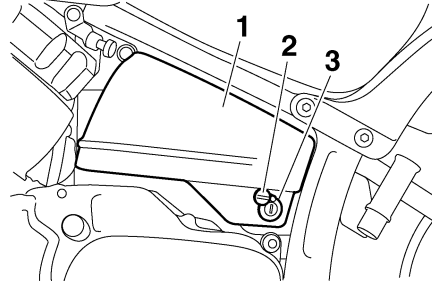

1. Storage compartment cover
2. Storage compartment lock cover
3. Storage compartment lock

2. Pull the storage compartment cover out as shown.

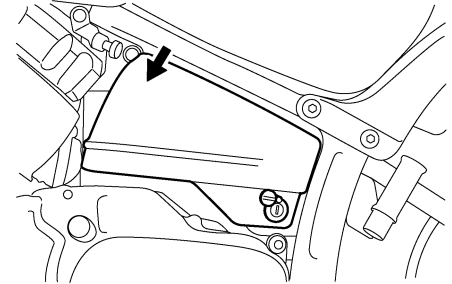

To close the storage compartment

1. Place the storage compartment cover in its original position as shown.

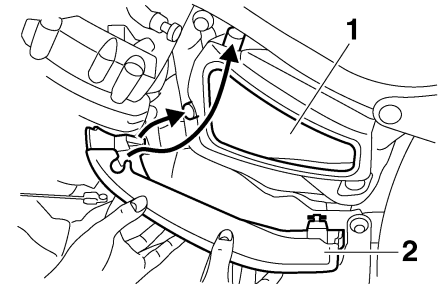

1. Storage compartment
2. Storage compartment cover

2. Turn the key counterclockwise, remove it, and then close the lock cover.

EAU14860

Adjusting the shock absorber assembly

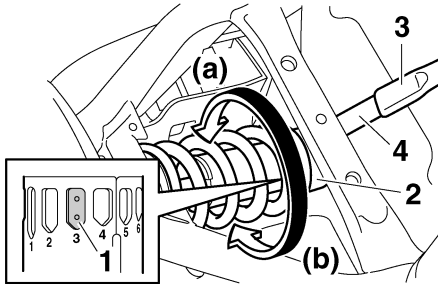

1. Position indicator
2. Spring preload adjusting ring
3. Extension bar
4. Special wrench

This shock absorber assembly is equipped with a spring preload adjusting ring.

ECA10100

CAUTION:

Never attempt to turn an adjusting mechanism beyond the maximum or minimum settings.

Adjust the spring preload as follows.

1. Remove the passenger and rider seats. (See page 3-11.)

2. To increase the spring preload and thereby harden the suspension, turn the adjusting ring in direction (a). To decrease the spring preload and thereby soften the suspension, turn the adjusting ring in direction (b).

NOTE:

- Align the appropriate notch in the adjusting ring with the position indicator on the shock absorber.
- Use the special wrench and extension bar included in the owner's tool kit to make the adjustment.

Spring preload setting:

Minimum (soft):

1

Standard:

3

Maximum (hard):

7

3. Install the passenger and rider seats.

WARNING

EWA10220

This shock absorber contains highly pressurized nitrogen gas. For proper handling, read and understand the following information before handling the shock absorber. The manufacturer cannot be held responsible for property damage or personal injury that may result from improper handling.

- Do not tamper with or attempt to open the gas cylinder.
- Do not subject the shock absorber to an open flame or other high heat sources, otherwise it may explode due to excessive gas pressure.
- Do not deform or damage the gas cylinder in any way, as this will result in poor damping performance.
- Always have a Yamaha dealer service the shock absorber.

INSTRUMENT AND CONTROL FUNCTIONS

Luggage strap holders

EAU15150

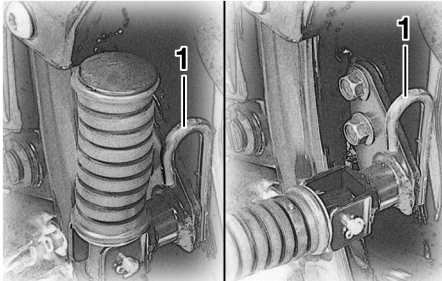

1. Luggage strap holder

There is a luggage strap holder on each passenger footrest.

Sidestand

EAU15301

The sidestand is located on the left side of the frame. Raise the sidestand or lower it with your foot while holding the vehicle upright.

NOTE:

The built-in sidestand switch is part of the ignition circuit cut-off system, which cuts the ignition in certain situations. (See further down for an explanation of the ignition circuit cut-off system.)

EWA10240

WARNING

The vehicle must not be ridden with the sidestand down, or if the sidestand cannot be properly moved up (or does not stay up), otherwise the sidestand could contact the ground and distract the operator, resulting in a possible loss of control. Yamaha's ignition circuit cut-off system has been designed to assist the operator in fulfilling the responsibility of raising the sidestand before starting off. Therefore, check this system regularly as described

below and have a Yamaha dealer repair it if it does not function properly.

EAU15311

Ignition circuit cut-off system

The ignition circuit cut-off system (comprising the sidestand switch, clutch switch and neutral switch) has the following functions.

- It prevents starting when the transmission is in gear and the sidestand is up, but the clutch lever is not pulled.
- It prevents starting when the transmission is in gear and the clutch lever is pulled, but the sidestand is still down.
- It cuts the running engine when the transmission is in gear and the sidestand is moved down.

Periodically check the operation of the ignition circuit cut-off system according to the following procedure.

EWA10250



If a malfunction is noted, have a Yamaha dealer check the system before riding.

INSTRUMENT AND CONTROL FUNCTIONS

3

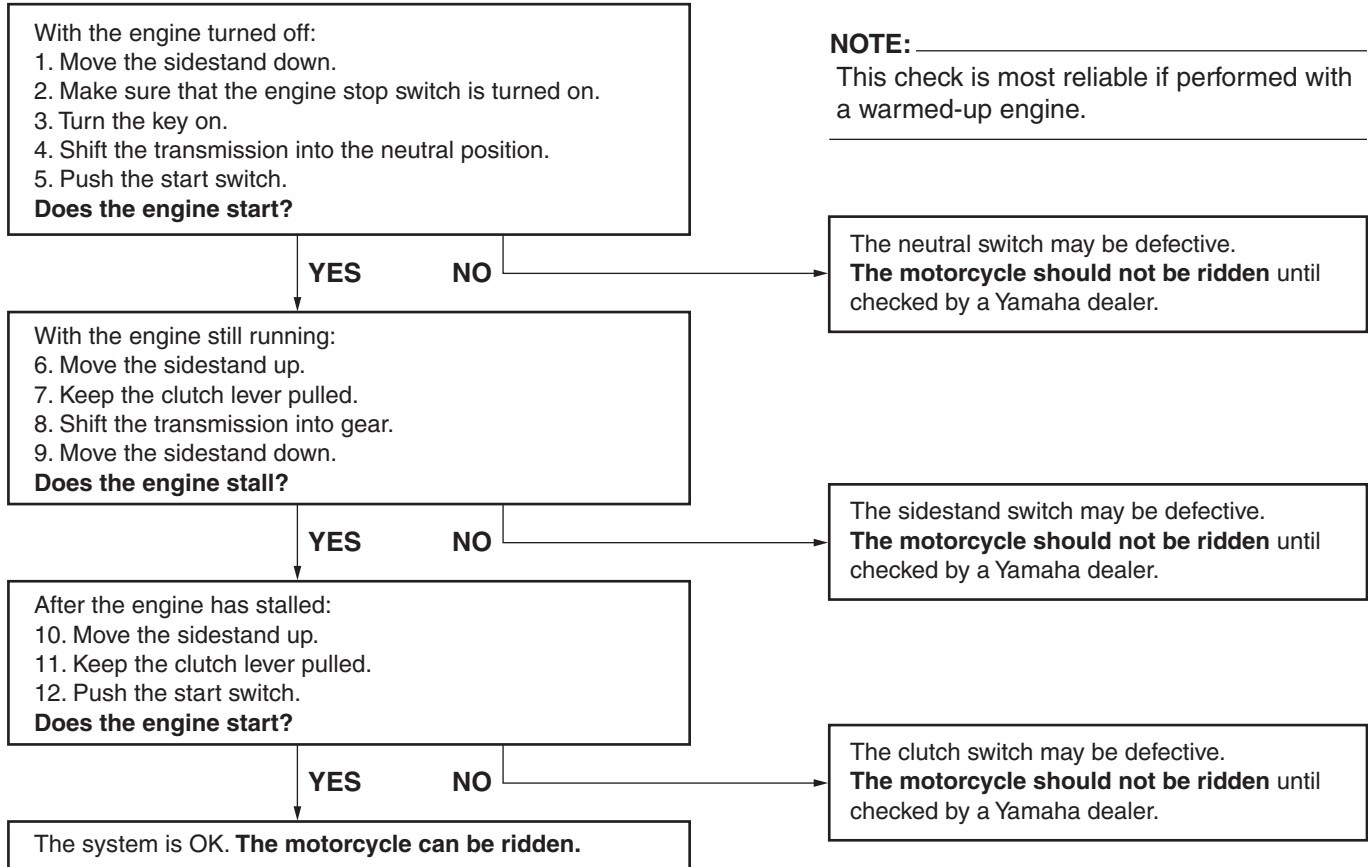

PRE-OPERATION CHECKS

EAU15591

The condition of a vehicle is the owner's responsibility. Vital components can start to deteriorate quickly and unexpectedly, even if the vehicle remains unused (for example, as a result of exposure to the elements). Any damage, fluid leakage or loss of tire air pressure could have serious consequences. Therefore, it is very important, in addition to a thorough visual inspection, to check the following points before each ride.

NOTE: _____

Pre-operation checks should be made each time the vehicle is used. Such an inspection can be accomplished in a very short time; and the added safety it assures is more than worth the time involved.

EWA11150



If any item in the Pre-operation check list is not working properly, have it inspected and repaired before operating the vehicle.

PRE-OPERATION CHECKS

EAU15603

Pre-operation check list

ITEM	CHECKS	PAGE
Fuel	<ul style="list-style-type: none">• Check fuel level in fuel tank.• Refuel if necessary.• Check fuel line for leakage.	3-9
Engine oil	<ul style="list-style-type: none">• Check oil level in engine.• If necessary, add recommended oil to specified level.• Check vehicle for oil leakage.	6-7
Final gear oil	<ul style="list-style-type: none">• Check vehicle for oil leakage.	6-10
4 Front brake	<ul style="list-style-type: none">• Check operation.• If soft or spongy, have Yamaha dealer bleed hydraulic system.• Check lever free play.• Adjust if necessary.• Check brake pads for wear.• Replace if necessary.• Check fluid level in reservoir.• If necessary, add recommended brake fluid to specified level.• Check hydraulic system for leakage.	6-18, 6-21, 6-21
Rear brake	<ul style="list-style-type: none">• Check operation.• Check pedal free play.• Adjust if necessary.	6-19, 6-21
Clutch	<ul style="list-style-type: none">• Check operation.• Lubricate cable if necessary.• Check lever free play.• Adjust if necessary.	6-17
Throttle grip	<ul style="list-style-type: none">• Make sure that operation is smooth.• Check cable free play.• If necessary, have Yamaha dealer adjust cable free play and lubricate cable and grip housing.	6-14, 6-23
Control cables	<ul style="list-style-type: none">• Make sure that operation is smooth.• Lubricate if necessary.	6-23

PRE-OPERATION CHECKS

ITEM	CHECKS	PAGE
Wheels and tires	<ul style="list-style-type: none">• Check for damage.• Check tire condition and tread depth.• Check air pressure.• Correct if necessary.	6-14, 6-17
Brake and shift pedals	<ul style="list-style-type: none">• Make sure that operation is smooth.• Lubricate pedal pivoting points if necessary.	6-23
Brake and clutch levers	<ul style="list-style-type: none">• Make sure that operation is smooth.• Lubricate lever pivoting points if necessary.	6-24
Sidestand	<ul style="list-style-type: none">• Make sure that operation is smooth.• Lubricate pivot if necessary.	6-25
Chassis fasteners	<ul style="list-style-type: none">• Make sure that all nuts, bolts and screws are properly tightened.• Tighten if necessary.	—
Instruments, lights, signals and switches	<ul style="list-style-type: none">• Check operation.• Correct if necessary.	—
Sidestand switch	<ul style="list-style-type: none">• Check operation of ignition circuit cut-off system.• If system is defective, have Yamaha dealer check vehicle.	3-16

OPERATION AND IMPORTANT RIDING POINTS

EAU15950

EWA10270

WARNING

- **Become thoroughly familiar with all operating controls and their functions before riding. Consult a Yamaha dealer regarding any control or function that you do not thoroughly understand.**
- **Never start the engine or operate it in a closed area for any length of time. Exhaust fumes are poisonous, and inhaling them can cause loss of consciousness and death within a short time. Always make sure that there is adequate ventilation.**
- **Before starting out, make sure that the sidestand is up. If the sidestand is not raised completely, it could contact the ground and distract the operator, resulting in a possible loss of control.**

Starting and warming up a cold engine

In order for the ignition circuit cut-off system to enable starting, one of the following conditions must be met:

- The transmission is in the neutral position.
- The transmission is in gear with the clutch lever pulled and the sidestand up.

EAU16411

EWA10290

WARNING

- **Before starting the engine, check the function of the ignition circuit cut-off system according to the procedure described on page 3-17.**
- **Never ride with the sidestand down.**

1. Turn the fuel cock lever to “ON”.
2. Turn the key to “ON” and make sure that the engine stop switch is set to “

NOTE: _____

When the transmission is in the neutral position, the neutral indicator light should be on, otherwise have a Yamaha dealer check the electrical circuit.

4. Turn the starter (choke) on and completely close the throttle. (See page 3-11.)
5. Start the engine by pushing the start switch.

NOTE: _____

If the engine fails to start, release the start switch, wait a few seconds, and then try again. Each starting attempt should be as short as possible to preserve the battery. Do not crank the engine more than 10 seconds on any one attempt.

ECA15210

CAUTION: _____

- **The engine trouble warning light should come on when the key is turned to “ON”, and then go off after a few seconds. If the warning light does not come on when the key is turned to “ON”,**

OPERATION AND IMPORTANT RIDING POINTS

then go off, have a Yamaha dealer check the electrical circuit. If the warning light comes on or flashes after starting, immediately stop the engine, and have a Yamaha dealer check the self-diagnosis system.

- For XVS650A only

The immobilizer system indicator light should come on when the key is turned to “ON”, and then go off after a few seconds. If the indicator light does not come on when the key is turned to “ON”, then go off, have a Yamaha dealer check the electrical circuit. If the indicator light flashes after starting, have a Yamaha dealer check the self-diagnosis system.

6. After starting the engine, move the starter (choke) back halfway.

ECA11130

CAUTION: _____

For maximum engine life, always warm the engine up before starting off. Never accelerate hard when the engine is cold!

7. When the engine is warm, turn the starter (choke) off.

NOTE: _____
The engine is warm when it responds normally to the throttle with the starter (choke) turned off.

EAU16640

Starting a warm engine

Follow the same procedure as for starting a cold engine with the exception that the starter (choke) is not required when the engine is warm.

OPERATION AND IMPORTANT RIDING POINTS

Shifting

EAU16671

XVS650

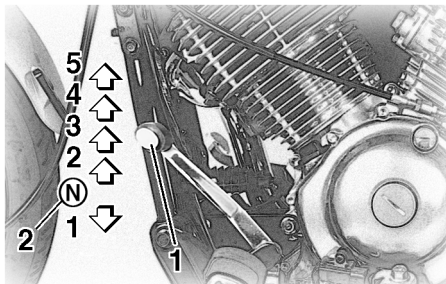

1. Shift pedal
2. Neutral position

XVS650A

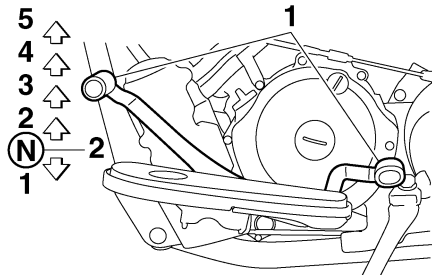

1. Shift pedal
2. Neutral position

Shifting gears lets you control the amount of engine power available for starting off, accelerating, climbing hills, etc.

The gear positions are shown in the illustration.

NOTE: _____

To shift the transmission into the neutral position, press the shift pedal down repeatedly until it reaches the end of its travel, and then slightly raise it.

ECA10260

CAUTION: _____

- Even with the transmission in the neutral position, do not coast for long periods of time with the engine off, and do not tow the motorcycle for long distances. The transmission is properly lubricated only when the engine is running. Inadequate lubrication may damage the transmission.
- Always use the clutch while changing gears to avoid damaging the engine, transmission,

and drive train, which are not designed to withstand the shock of forced shifting.

OPERATION AND IMPORTANT RIDING POINTS

Tips for reducing fuel consumption

EAU16800

Fuel consumption depends largely on your riding style. Consider the following tips to reduce fuel consumption:

- Turn the starter (choke) off as soon as possible.
- Shift up swiftly, and avoid high engine speeds during acceleration.
- Do not rev the engine while shifting down, and avoid high engine speeds with no load on the engine.
- Turn the engine off instead of letting it idle for an extended length of time (e.g., in traffic jams, at traffic lights or at railroad crossings).

Engine break-in

EAU16841

There is never a more important period in the life of your engine than the period between 0 and 1600 km (1000 mi). For this reason, you should read the following material carefully.

Since the engine is brand new, do not put an excessive load on it for the first 1600 km (1000 mi). The various parts in the engine wear and polish themselves to the correct operating clearances. During this period, prolonged full-throttle operation or any condition that might result in engine overheating must be avoided.

EAU17041

0–1000 km (0–600 mi)

Avoid prolonged operation above 1/3 throttle.

1000–1600 km (600–1000 mi)

Avoid prolonged operation above 1/2 throttle.

ECA10331

CAUTION:

After 1000 km (600 mi) of operation, the engine oil and final gear oil must be changed, and the oil filter cartridge or element replaced.

1600 km (1000 mi) and beyond

The vehicle can now be operated normally.

ECA10270

CAUTION:

If any engine trouble should occur during the engine break-in period, immediately have a Yamaha dealer check the vehicle.

OPERATION AND IMPORTANT RIDING POINTS

EAU17170

Parking

When parking, stop the engine, remove the key from the main switch, and then turn the fuel cock lever to “OFF”.

EWA10310

WARNING

- **Since the engine and exhaust system can become very hot, park in a place where pedestrians or children are not likely to touch them.**
- **Do not park on a slope or on soft ground, otherwise the vehicle may overturn.**

EAU17240

EAU17450

EWA10350

Safety is an obligation of the owner. Periodic inspection, adjustment and lubrication will keep your vehicle in the safest and most efficient condition possible. The most important points of inspection, adjustment, and lubrication are explained on the following pages. The intervals given in the periodic maintenance and lubrication chart should be simply considered as a general guide under normal riding conditions. However, DEPENDING ON THE WEATHER, TERRAIN, GEOGRAPHICAL LOCATION, AND INDIVIDUAL USE, THE MAINTENANCE INTERVALS MAY NEED TO BE SHORTENED.

EWA10320

! WARNING

If you are not familiar with maintenance work, have a Yamaha dealer do it for you.

Owner's tool kit

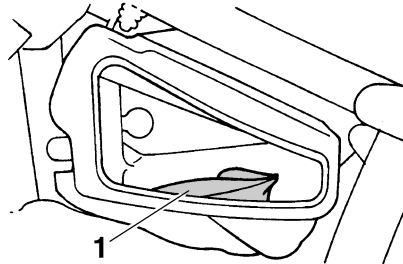

1. Owner's tool kit

The owner's tool kit is located inside the storage compartment. (See page 3-14.)

The service information included in this manual and the tools provided in the owner's tool kit are intended to assist you in the performance of preventive maintenance and minor repairs. However, additional tools such as a torque wrench may be necessary to perform certain maintenance work correctly.

NOTE:

If you do not have the tools or experience required for a particular job, have a Yamaha dealer perform it for you.

! WARNING

Modifications not approved by Yamaha may cause loss of performance and render the vehicle unsafe for use. Consult a Yamaha dealer before attempting any changes.

PERIODIC MAINTENANCE AND MINOR REPAIR

EAU17705

Periodic maintenance and lubrication chart

NOTE:

- The annual checks must be performed every year, except if a kilometer-based maintenance is performed instead.
- From 50000 km, repeat the maintenance intervals starting from 10000 km.
- Items marked with an asterisk should be performed by a Yamaha dealer as they require special tools, data and technical skills.

NO.	ITEM	CHECK OR MAINTENANCE JOB	ODOMETER READING (× 1000 km)					ANNUAL CHECK
			1	10	20	30	40	
1	* Fuel line	• Check fuel hoses for cracks or damage.		√	√	√	√	√
2	* Fuel filter	• Check condition.			√		√	
3	Spark plugs	• Check condition. • Clean and regap.		√		√		
		• Replace.			√		√	
4	* Valves	• Check valve clearance. • Adjust.		√	√	√	√	
5	Air filter element	• Clean.		√		√		
		• Replace.			√		√	
6	Clutch	• Check operation. • Adjust.	√	√	√	√	√	
7	* Front brake	• Check operation, fluid level and vehicle for fluid leakage.	√	√	√	√	√	√
		• Replace brake pads.	Whenever worn to the limit					
8	* Rear brake	• Check operation and adjust brake pedal free play.	√	√	√	√	√	√
		• Replace brake shoes.	Whenever worn to the limit					

PERIODIC MAINTENANCE AND MINOR REPAIR

NO.	ITEM	CHECK OR MAINTENANCE JOB	ODOMETER READING (× 1000 km)					ANNUAL CHECK
			1	10	20	30	40	
9	*	Brake hose • Check for cracks or damage. • Replace.		√	√	√	√	√
			Every 4 years					
10	*	Wheels • Check runout, spoke tightness and for damage. • Tighten spokes if necessary.		√	√	√	√	
11	*	Tires • Check tread depth and for damage. • Replace if necessary. • Check air pressure. • Correct if necessary.		√	√	√	√	√
12	*	Wheel bearings • Check bearing for looseness or damage.		√	√	√	√	
13	*	Swingarm • Check operation and for excessive play. • Lubricate with lithium-soap-based grease.		√	√	√	√	
			Every 50000 km					
14	*	Steering bearings • Check bearing play and steering for roughness. • Lubricate with lithium-soap-based grease.	√	√	√	√	√	
			Every 20000 km					
15	*	Chassis fasteners • Make sure that all nuts, bolts and screws are properly tightened.		√	√	√	√	√
16		Sidestand • Check operation. • Lubricate.		√	√	√	√	√
17	*	Sidestand switch • Check operation.	√	√	√	√	√	√
18	*	Front fork • Check operation and for oil leakage.		√	√	√	√	
19	*	Shock absorber assembly • Check operation and shock absorber for oil leakage.		√	√	√	√	
20	*	Carburetors • Check starter (choke) operation. • Adjust engine idling speed and synchronization.	√	√	√	√	√	√
21		Engine oil • Change. • Check oil level and vehicle for oil leakage.	√	√	√	√	√	√

PERIODIC MAINTENANCE AND MINOR REPAIR

NO.	ITEM	CHECK OR MAINTENANCE JOB	ODOMETER READING (× 1000 km)					ANNUAL CHECK
			1	10	20	30	40	
22	Engine oil filter element	• Replace.	√		√		√	
23	Final gear oil	• Check oil level and vehicle for oil leakage.	√	√		√		
		• Change.	√		√		√	
24 *	Front and rear brake switches	• Check operation.	√	√	√	√	√	√
25	Moving parts and cables	• Lubricate.		√	√	√	√	√
26 *	Throttle grip housing and cable	• Check operation and free play. • Adjust the throttle cable free play if necessary. • Lubricate the throttle grip housing and cable.		√	√	√	√	√
27 *	Muffler and exhaust pipe	• Check the screw clamp for looseness.	√	√	√	√	√	
28 *	Lights, signals and switches	• Check operation. • Adjust headlight beam.	√	√	√	√	√	√

6

EAU18660

NOTE:

- The air filter needs more frequent service if you are riding in unusually wet or dusty areas.
- Hydraulic brake service
 - Regularly check and, if necessary, correct the brake fluid level.
 - Every two years replace the internal components of the brake master cylinder and caliper, and change the brake fluid.
 - Replace the brake hoses every four years and if cracked or damaged.

PERIODIC MAINTENANCE AND MINOR REPAIR

Removing and installing panels

The panels shown need to be removed to perform some of the maintenance jobs described in this chapter. Refer to this section each time a panel needs to be removed and installed.

XVS650

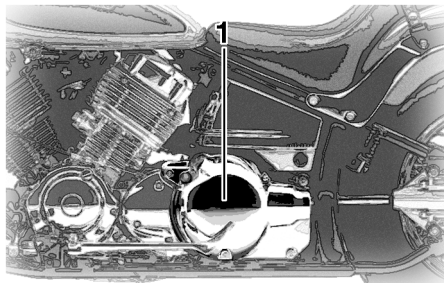

1. Panel A

EAU18771

XVS650A

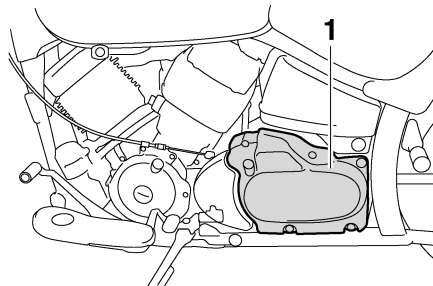

1. Panel A

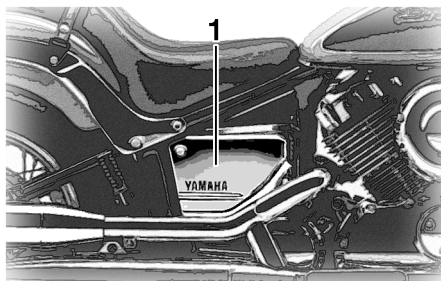

1. Panel B

XVS650

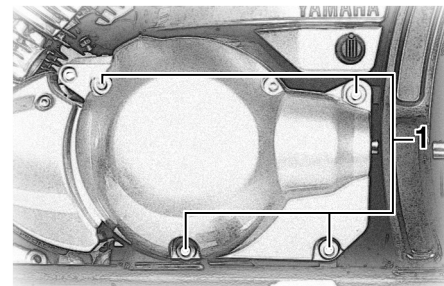

1. Bolt

XVS650A

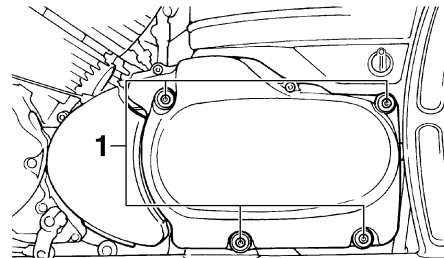

1. Bolt

Panel A

EAU19193

To remove the panel

Remove the bolts, and then take the panel off.

To install the panel

Place the panel in the original position, and then install the bolts.

PERIODIC MAINTENANCE AND MINOR REPAIR

Panel B

EAU19151

To remove the panel

Remove the bolt, and then pull the panel off as shown.

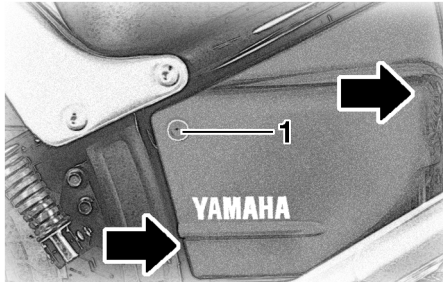

1. Bolt

To install the panel

Place the panel in the original position, and then install the bolt.

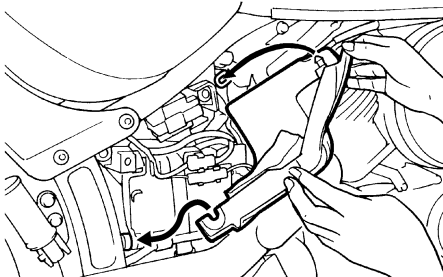

EAU19543

Checking the spark plugs

The spark plugs are important engine components, which are easy to check. Since heat and deposits will cause any spark plug to slowly erode, the spark plugs should be removed and checked in accordance with the periodic maintenance and lubrication chart. In addition, the condition of the spark plugs can reveal the condition of the engine.

To remove a spark plug

1. Remove the spark plug cap.

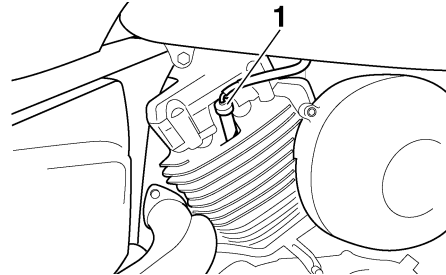

1. Spark plug cap

2. Remove the spark plug as shown, with the spark plug wrench included in the owner's tool kit.

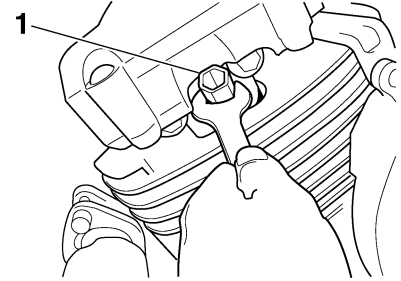

1. Spark plug wrench

To check the spark plugs

1. Check that the porcelain insulator around the center electrode on each spark plug is a medium-to-light tan (the ideal color when the vehicle is ridden normally).
2. Check that all spark plugs installed in the engine have the same color.

NOTE:

If any spark plug shows a distinctly different color, the engine could be defective. Do not attempt to diagnose such problems yourself. Instead, have a Yamaha dealer check the vehicle.

PERIODIC MAINTENANCE AND MINOR REPAIR

EAU19742

3. Check each spark plug for electrode erosion and excessive carbon or other deposits, and replace it if necessary.

Specified spark plug:
NGK/DPR7EA-9
DENSO/X22EPR-U9

To install a spark plug

1. Measure the spark plug gap with a wire thickness gauge and, if necessary, adjust the gap to specification.

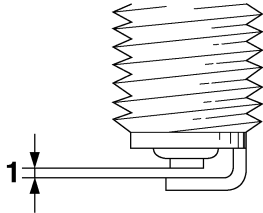

1. Spark plug gap

Spark plug gap:
0.8–0.9 mm (0.031–0.035 in)

2. Clean the surface of the spark plug gasket and its mating surface, and then wipe off any grime from the spark plug threads.
3. Install the spark plug with the spark plug wrench, and then tighten it to the specified torque.

Tightening torque:

Spark plug:
17.5 Nm (1.75 m-kgf, 12.7 ft-lbf)

NOTE:

If a torque wrench is not available when installing a spark plug, a good estimate of the correct torque is 1/4–1/2 turn past finger tight. However, the spark plug should be tightened to the specified torque as soon as possible.

4. Install the spark plug cap.

Engine oil and oil filter element

The engine oil level should be checked before each ride. In addition, the oil must be changed and the oil filter element replaced at the intervals specified in the periodic maintenance and lubrication chart.

To check the engine oil level

1. Place the vehicle on a level surface and hold it in an upright position.

NOTE:

Make sure that the vehicle is positioned straight up when checking the oil level. A slight tilt to the side can result in a false reading.

2. Start the engine, warm it up for several minutes, and then turn it off.
3. Wait a few minutes until the oil settles, and then check the oil level through the check window located at the bottom-left side of the crankcase.

PERIODIC MAINTENANCE AND MINOR REPAIR

NOTE:

The engine oil should be between the minimum and maximum level marks.

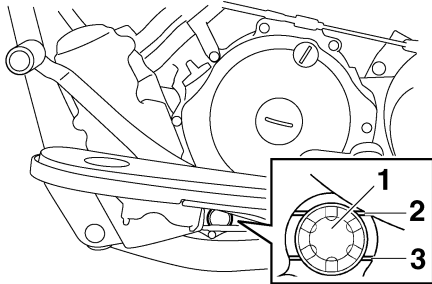

1. Engine oil level check window
2. Maximum level mark
3. Minimum level mark

4. If the engine oil is at or below the minimum level mark, add sufficient oil of the recommended type to raise it to the correct level.

To change the engine oil (with or without oil filter element replacement)

1. Start the engine, warm it up for several minutes, and then turn it off.

2. Place an oil pan under the engine to collect the used oil.
3. Remove the engine oil filler cap and drain bolt to drain the oil from the crankcase.

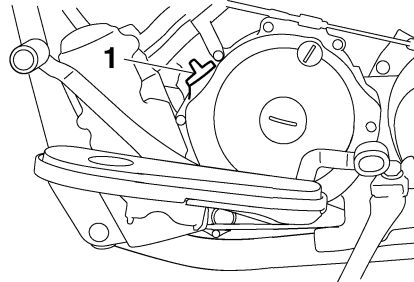

1. Engine oil filler cap

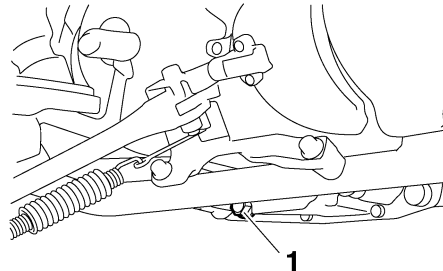

1. Engine oil drain bolt

NOTE:

Skip steps 4–7 if the oil filter element is not being replaced.

4. Remove the outer and inner oil filter element covers by removing the bolts.

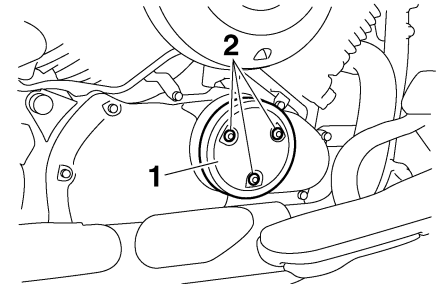

1. Outer oil filter element cover
2. Bolt

PERIODIC MAINTENANCE AND MINOR REPAIR

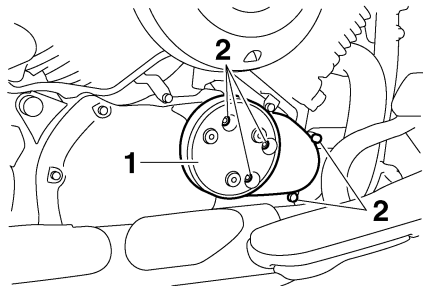

1. Inner oil filter element cover
2. Bolt

5. Remove the oil filter element and O-ring.

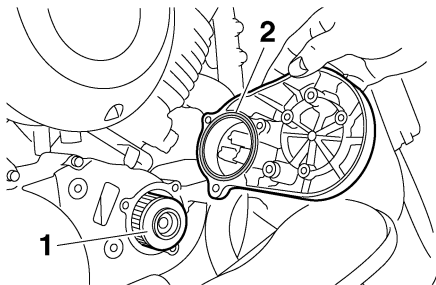

1. Oil filter element
2. O-ring

6. Install a new oil filter element and the O-ring.

7. Install the oil filter element covers by installing the bolts, and then tighten them to the specified torque.

Tightening torque:

Oil filter element cover bolt:
10 Nm (1.0 m·kgf, 7 ft·lbf)

8. Install the engine oil drain bolt, and then tighten it to the specified torque.

NOTE: _____
Check the washer for damage and replace it if necessary.

Tightening torque:

Engine oil drain bolt:
43 Nm (4.3 m·kgf, 31 ft·lbf)

9. Add the specified amount of the recommended oil, and then install and tighten the oil filler cap.

Recommended engine oil:

See page 8-1.

Oil quantity:

Without oil filter element replacement:

2.60 L (2.75 US qt) (2.29 Imp.qt)

With oil filter element replacement:

2.80 L (2.96 US qt) (2.46 Imp.qt)

ECA11620

CAUTION:

- In order to prevent clutch slippage (since the engine oil also lubricates the clutch), do not mix any chemical additives. Do not use oils with a diesel specification of “CD” or oils of a higher quality than specified. In addition, do not use oils labeled “ENERGY CONSERVING II” or higher.
- Make sure that no foreign material enters the crankcase.

10. Start the engine, and then let it idle for several minutes while checking it for oil leakage. If oil is leaking, immediately turn the engine off and check for the cause.

PERIODIC MAINTENANCE AND MINOR REPAIR

11. Turn the engine off, and then check the oil level and correct it if necessary.

Final gear oil

The final gear case must be checked for oil leakage before each ride. If any leakage is found, have a Yamaha dealer check and repair the vehicle. In addition, the final gear oil level must be checked and the oil changed as follows at the intervals specified in the periodic maintenance and lubrication chart.

EAU20022

EWA10370

WARNING

- Make sure that no foreign material enters the final gear case.
- Make sure that no oil gets on the tire or wheel.

To check the final gear oil level

1. Place the vehicle on a level surface and hold it in an upright position.

NOTE: _____

- The final gear oil level must be checked on a cold engine.
- Make sure that the vehicle is positioned straight up when checking the oil level. A slight tilt to the side can result in a false reading.

2. Remove the oil filler bolt, and then check the oil level in the final gear case.

NOTE: _____

The oil level should be at the brim of the filler hole.

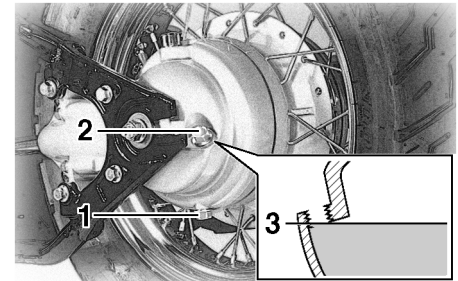

1. Final gear oil drain bolt
2. Final gear oil filler bolt
3. Correct oil level

3. If the oil is below the brim of the filler hole, add sufficient oil of the recommended type to raise it to the correct level.

To change the final gear oil

1. Place an oil pan under the final gear case to collect the used oil.

PERIODIC MAINTENANCE AND MINOR REPAIR

2. Remove the oil filler bolt and drain bolt to drain the oil from the final gear case.
3. Install the final gear oil drain bolt, and then tighten it to the specified torque.

Tightening torque:

Final gear oil drain bolt:
23 Nm (2.3 m·kgf, 17 ft·lbf)

4. Add the recommended final gear oil to the brim of the filler hole.

Recommended final gear oil:

SAE80 API GL-4 Hypoid gear oil

Oil quantity:

0.19 L (0.20 US qt) (0.17 Imp.qt)

NOTE:

GL4 is a quality rating. Hypoid gear oils rated GL5 or GL6 may also be used.

5. Install the oil filler bolt, and then tighten it to the specified torque.

Tightening torque:

Final gear oil filler bolt:
23 Nm (2.3 m·kgf, 17 ft·lbf)

6. Check the final gear case for oil leakage. If oil is leaking, check for the cause.

Cleaning the air filter element

EAU33381

The air filter element should be cleaned at the intervals specified in the periodic maintenance and lubrication chart. Clean the air filter element more frequently if you are riding in unusually wet or dusty areas.

1. Remove the air filter case cover by removing the bolts.

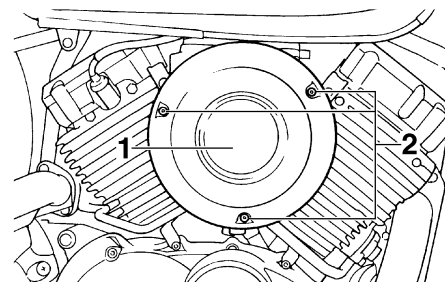

1. Air filter case cover

2. Bolt

2. Pull the air filter element out.
3. Lightly tap the air filter element to remove most of the dust and dirt, and then blow the remaining dirt out with compressed air as shown. If the air filter element is damaged, replace it.

PERIODIC MAINTENANCE AND MINOR REPAIR

ECA10480

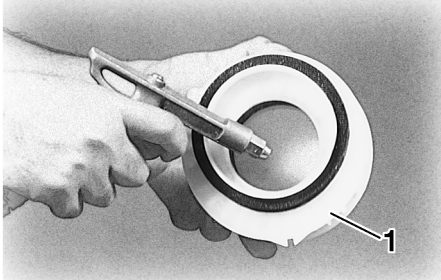

1. Air filter element

4. Insert the air filter element into the air filter case as shown.

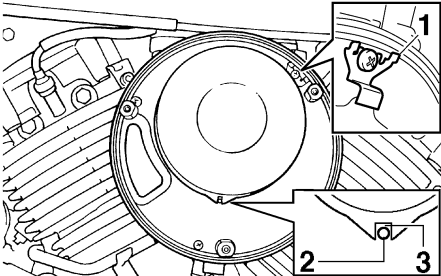

1. Air filter element holder
2. Projection
3. Slot

CAUTION:

- Make sure that the air filter element is properly seated in the air filter case.
- The engine should never be operated without the air filter element installed, otherwise the piston(s) and/or cylinder(s) may become excessively worn.

5. Install the air filter case cover by aligning the match marks and installing the bolts.

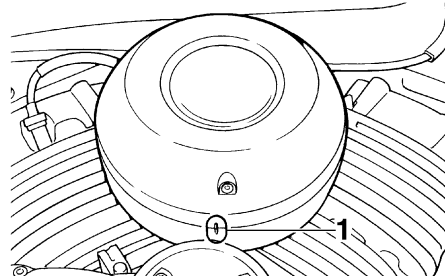

1. Match marks

NOTE:

If dust or water collects in the air filter check hose, remove the clamp from it, and then remove the plug to drain the hose.

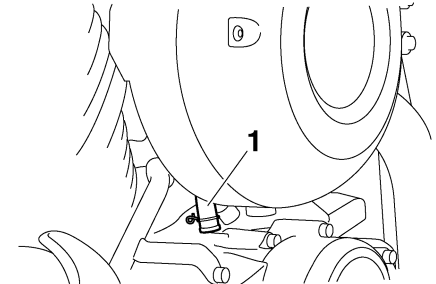

1. Air filter check hose

PERIODIC MAINTENANCE AND MINOR REPAIR

Adjusting the carburetors

EAU21290

The carburetors are important parts of the engine and require very sophisticated adjustment. Therefore, most carburetor adjustments should be left to a Yamaha dealer, who has the necessary professional knowledge and experience. The adjustment described in the following section, however, may be serviced by the owner as part of routine maintenance.

CAUTION:

ECA10560

The carburetors have been set and extensively tested at the Yamaha factory. Changing these settings without sufficient technical knowledge may result in poor performance of or damage to the engine.

Adjusting the engine idling speed

EAU21340

The engine idling speed must be checked and, if necessary, adjusted as follows at the intervals specified in the periodic maintenance and lubrication chart.

The engine should be warm before making this adjustment.

NOTE:

- The engine is warm when it quickly responds to the throttle.
- A diagnostic tachometer is needed to make this adjustment.

1. Attach the tachometer to the spark plug lead.
2. Check the engine idling speed and, if necessary, adjust it to specification by turning the throttle stop screw. To increase the engine idling speed, turn the screw in direction (a). To decrease the engine idling speed, turn the screw in direction (b).

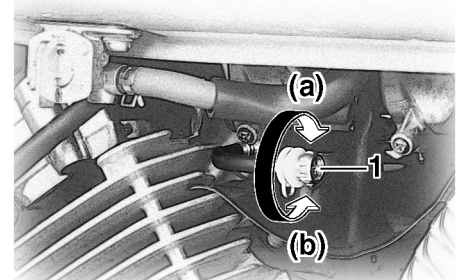

1. Throttle stop screw

Engine idling speed:
1150–1250 r/min

NOTE:

If the specified idling speed cannot be obtained as described above, have a Yamaha dealer make the adjustment.

PERIODIC MAINTENANCE AND MINOR REPAIR

EAU21381

Checking the throttle cable free play

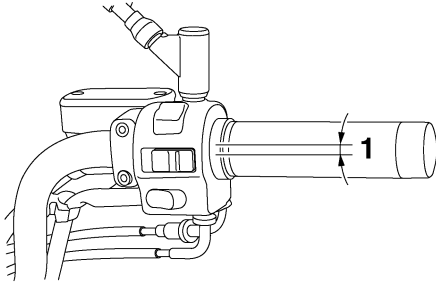

1. Throttle cable free play

The throttle cable free play should measure 4.0–6.0 mm (0.16–0.24 in) at the throttle grip. Periodically check the throttle cable free play and, if necessary, have a Yamaha dealer adjust it.

6

Valve clearance

The valve clearance changes with use, resulting in improper air-fuel mixture and/or engine noise. To prevent this from occurring, the valve clearance must be adjusted by a Yamaha dealer at the intervals specified in the periodic maintenance and lubrication chart.

EAU21401

Tires

To maximize the performance, durability, and safe operation of your motorcycle, note the following points regarding the specified tires.

Tire air pressure

The tire air pressure should be checked and, if necessary, adjusted before each ride.

EAU32771

EWA10500

⚠ WARNING

- The tire air pressure must be checked and adjusted on cold tires (i.e., when the temperature of the tires equals the ambient temperature).
- The tire air pressure must be adjusted in accordance with the riding speed and with the total weight of rider, passenger, cargo, and accessories approved for this model.

PERIODIC MAINTENANCE AND MINOR REPAIR

Tire air pressure (measured on cold tires):

0–90 kg (0–198 lb):

Front:

XVS650 200 kPa (29 psi) (2.00 kgf/cm²)

XVS650A 225 kPa (33 psi)
(2.25 kgf/cm²)

Rear:

225 kPa (33 psi) (2.25 kgf/cm²)

XVS650 90–180 kg (198–397 lb)

XVS650A 90–200 kg (198–441 lb):

Front:

XVS650 200 kPa (29 psi) (2.00 kgf/cm²)

XVS650A 225 kPa (33 psi)
(2.25 kgf/cm²)

Rear:

250 kPa (36 psi) (2.50 kgf/cm²)

Maximum load*:

XVS650 180 kg (397 lb)

XVS650A 200 kg (441 lb)

* Total weight of rider, passenger, cargo and accessories

EWA10510

WARNING

Proper loading of your vehicle is important for several characteristics of your vehicle, such as handling, braking, performance and safety. Do not carry loosely packed items that

can shift. Securely pack your heaviest items close to the center of the vehicle, and distribute the weight evenly from side to side. Properly adjust the suspension for your load, and check the condition and pressure of your tires. **NEVER OVERLOAD YOUR VEHICLE.** Make sure that the total weight of the cargo, rider, passenger, and accessories (cowling, saddlebags, etc. if approved for this model) does not exceed the maximum load of the vehicle. Operation of an overloaded vehicle could cause tire damage, an accident, or even injury.

Tire inspection

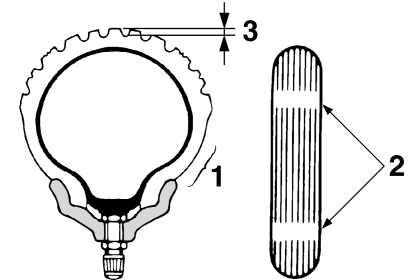

1. Tire sidewall
2. Tire wear indicator
3. Tire tread depth

Always check the tires before operating the motorcycle. If a tire tread shows crosswise lines (minimum tread depth), if the tire has a nail or glass fragments in it, or if the sidewall is cracked, contact a Yamaha dealer immediately and have the tire replaced.

Minimum tire tread depth (front and rear):

1.0 mm (0.04 in)

PERIODIC MAINTENANCE AND MINOR REPAIR

NOTE: _____

The tire tread depth limits may differ from country to country. Always comply with the local regulations.

EWA10560

WARNING _____

- It is dangerous to ride with a worn-out tire. When a tire tread begins to show crosswise lines, have a Yamaha dealer replace the tire immediately.
- The replacement of all wheel- and brake-related parts, including the tires, should be left to a Yamaha dealer, who has the necessary professional knowledge and experience.
- It is not recommended to patch a punctured tube. If unavoidable, however, patch the tube very carefully and replace it as soon as possible with a high-quality product.

WARNING _____

EWA10460

- The front and rear tires should be of the same make and design, otherwise the handling characteristics of the vehicle cannot be guaranteed.
- After extensive tests, only the tires listed below have been approved for this model by Yamaha Motor Co., Ltd.

Front tire:

Size:

XVS650 100/90-19M/C 57S
XVS650A 130/90-16M/C 67S

Manufacturer/model:

XVS650 BRIDGESTONE/EXE-DRA L309
XVS650A BRIDGESTONE/EXE-DRA G703
XVS650 DUNLOP/F24
XVS650A DUNLOP/D404F

Rear tire:

Size:

170/80-15M/C 77S

Manufacturer/model:

XVS650 BRIDGESTONE/EXE-DRA G546
XVS650A BRIDGESTONE/EXE-DRA G702
XVS650 DUNLOP/K555
XVS650A DUNLOP/D404G

6

Tire information

This motorcycle is equipped with spoke wheels and tube tires.

PERIODIC MAINTENANCE AND MINOR REPAIR

Spoke wheels

EAU21940

To maximize the performance, durability, and safe operation of your motorcycle, note the following points regarding the specified wheels.

- The wheel rims should be checked for cracks, bends or warpage, and the spokes for looseness or damage before each ride. If any damage is found, have a Yamaha dealer replace the wheel. Do not attempt even the smallest repair to the wheel. A deformed or cracked wheel must be replaced.
- The wheel should be balanced whenever either the tire or wheel has been changed or replaced. An unbalanced wheel can result in poor performance, adverse handling characteristics, and a shortened tire life.
- Ride at moderate speeds after changing a tire since the tire surface must first be “broken in” for it to develop its optimal characteristics.

Adjusting the clutch lever free play

EAU22041

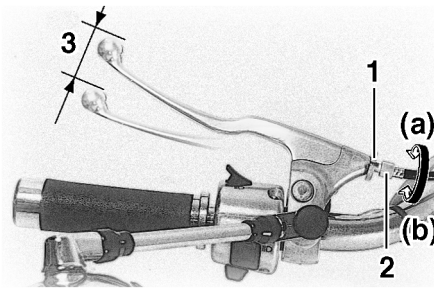

1. Locknut
2. Clutch lever free play adjusting bolt
3. Clutch lever free play

The clutch lever free play should measure XVS650 10.0–15.0 mm (0.39–0.59 in)

XVS650A 5.0–10.0 mm (0.20–0.39 in) as shown. Periodically check the clutch lever free play and, if necessary, adjust it as follows.

1. Loosen the locknut at the clutch lever.

2. To increase the clutch lever free play, turn the adjusting bolt in direction (a). To decrease the clutch lever free play, turn the adjusting bolt in direction (b).

NOTE:

If the specified clutch lever free play could be obtained as described above, tighten the locknut and skip the rest of the procedure, otherwise proceed as follows.

3. Fully turn the adjusting bolt at the clutch lever in direction (a) to loosen the clutch cable.
4. Loosen the locknut at the crankcase.

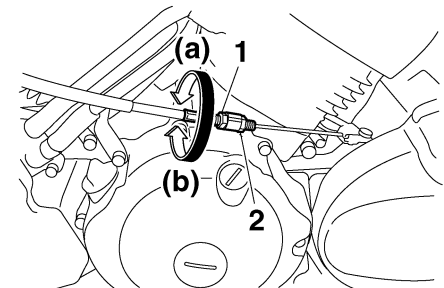

1. Clutch lever free play adjusting nut (crankcase)
2. Locknut

PERIODIC MAINTENANCE AND MINOR REPAIR

5. To increase the clutch lever free play, turn the adjusting nut in direction (a). To decrease the clutch lever free play, turn the adjusting nut in direction (b).
6. Tighten the locknut at the clutch lever and the crankcase.

Adjusting the brake lever free play

EAU22092

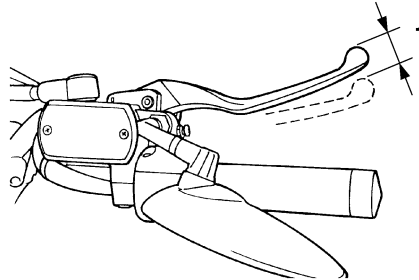

1. Brake lever free play

The brake lever free play should measure 10.0–15.0 mm (0.39–0.59 in) as shown. Periodically check the brake lever free play and, if necessary, adjust it as follows.

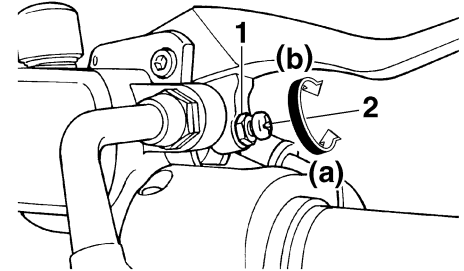

1. Locknut

2. Brake lever free play adjusting screw

1. Loosen the locknut at the brake lever.
2. To increase the brake lever free play, turn the adjusting screw in direction (a). To decrease the brake lever free play, turn the adjusting screw in direction (b).
3. Tighten the locknut.

EWA10630

WARNING

- After adjusting the brake lever free play, check the free play and make sure that the brake is working properly.
- A soft or spongy feeling in the brake lever can indicate the presence of air in the hydraulic

system. If there is air in the hydraulic system, have a Yamaha dealer bleed the system before operating the motorcycle. Air in the hydraulic system will diminish the braking performance, which may result in loss of control and an accident.

Adjusting the brake pedal position and free play

EAU22231

EWA10670

XVS650

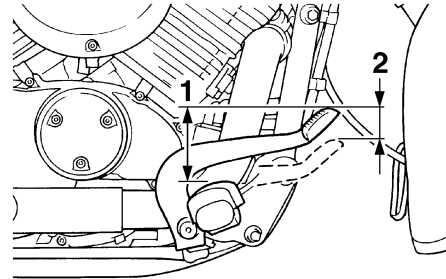

1. Distance between brake pedal and footrest
2. Brake pedal free play

XVS650A

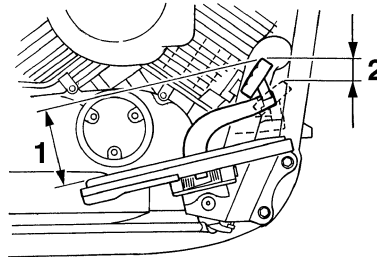

1. Distance between brake pedal and footrest
2. Brake pedal free play

WARNING

It is advisable to have a Yamaha dealer make these adjustments.

NOTE:

The brake pedal position should be adjusted before adjusting the brake pedal free play.

Brake pedal position

The brake pedal should be positioned approximately XVS650 102.0 mm (4.02 in)

XVS650A 108.0 mm (4.25 in) above the top of the footrest as shown. Periodically check the brake pedal position and, if necessary, adjust it as follows.

1. Loosen the locknut at the brake pedal.
2. To raise the brake pedal, turn the adjusting bolt in direction (a). To lower the brake pedal, turn the adjusting bolt in direction (b).

PERIODIC MAINTENANCE AND MINOR REPAIR

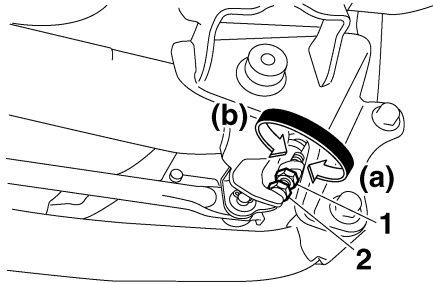

1. Locknut
 2. Brake pedal position adjusting bolt
3. Tighten the locknut.

EWA11230

WARNING

6

After adjusting the brake pedal position, the brake pedal free play must be adjusted.

Brake pedal free play

The brake pedal free play should measure 20.0–30.0 mm (0.79–1.18 in) at the brake pedal end. Periodically check the brake pedal free play and, if necessary, adjust it as follows.

To increase the brake pedal free play, turn the adjusting nut at the brake rod in direction (a). To decrease the brake pedal free play, turn the adjusting nut in direction (b).

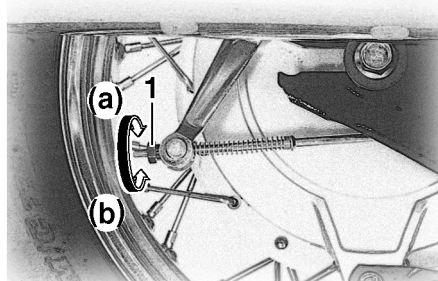

1. Brake pedal free play adjusting nut

Adjusting the rear brake light switch

EAU22270

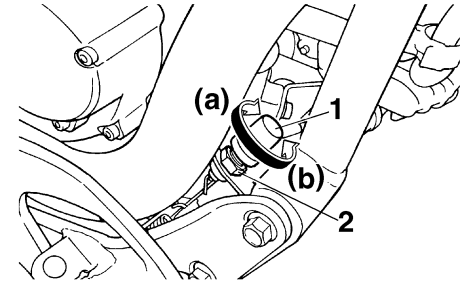

1. Brake light switch
2. Rear brake light switch adjusting nut

The rear brake light switch, which is activated by the brake pedal, is properly adjusted when the brake light comes on just before braking takes effect. If necessary, adjust the brake light switch as follows.

Turn the adjusting nut while holding the rear brake light switch in place. To make the brake light come on earlier, turn the adjusting nut in direction (a). To make the brake light come on later, turn the adjusting nut in direction (b).

Checking the front brake pads and rear brake shoes

EAU22380

The front brake pads and the rear brake shoes must be checked for wear at the intervals specified in the periodic maintenance and lubrication chart.

Front brake pads

EAU22430

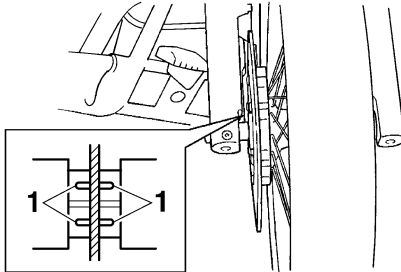

1. Brake pad wear indicator groove

Each front brake pad is provided with wear indicator grooves, which allow you to check the brake pad wear without having to disassemble the brake. To check the brake pad wear, check the wear indicator grooves. If a brake pad has worn to the point that the wear

indicator grooves have almost disappeared, have a Yamaha dealer replace the brake pads as a set.

Rear brake shoes

EAU22540

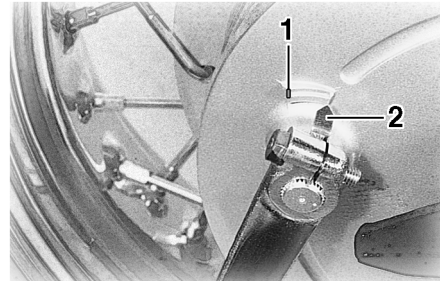

1. Brake shoe wear limit line
2. Brake shoe wear indicator

The rear brake is provided with a wear indicator, which allows you to check the brake shoe wear without having to disassemble the brake. To check the brake shoe wear, check the position of the wear indicator while applying the brake. If a brake shoe has worn to the point that the wear indicator reaches the wear limit line, have a Yamaha dealer replace the brake shoes as a set.

Checking the front brake fluid level

EAU32343

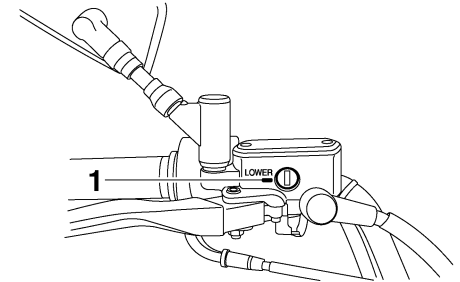

1. Minimum level mark

Insufficient brake fluid may allow air to enter the brake system, possibly causing it to become ineffective.

Before riding, check that the brake fluid is above the minimum level mark and replenish if necessary. A low brake fluid level may indicate worn brake pads and/or brake system leakage. If the brake fluid level is low, be sure to check the brake pads for wear and the brake system for leakage.

Observe these precautions:

PERIODIC MAINTENANCE AND MINOR REPAIR

- When checking the fluid level, make sure that the top of the master cylinder is level by turning the handlebars.
- Use only the recommended quality brake fluid, otherwise the rubber seals may deteriorate, causing leakage and poor braking performance.

Recommended brake fluid:

DOT 4

- Refill with the same type of brake fluid. Mixing fluids may result in a harmful chemical reaction and lead to poor braking performance.
- Be careful that water does not enter the master cylinder when refilling. Water will significantly lower the boiling point of the fluid and may result in vapor lock.
- Brake fluid may deteriorate painted surfaces or plastic parts. Always clean up spilled fluid immediately.
- As the brake pads wear, it is normal for the brake fluid level to gradually go down. However, if the

brake fluid level goes down suddenly, have a Yamaha dealer check the cause.

Changing the brake fluid

EAU22720

Have a Yamaha dealer change the brake fluid at the intervals specified in the NOTE after the periodic maintenance and lubrication chart. In addition, have the oil seals of the brake master cylinder and caliper as well as the brake hose replaced at the intervals listed below or whenever they are damaged or leaking.

- Oil seals: Replace every two years.
- Brake hose: Replace every four years.

PERIODIC MAINTENANCE AND MINOR REPAIR

Checking and lubricating the cables

EAU23100

The operation of all control cables and the condition of the cables should be checked before each ride, and the cables and cable ends should be lubricated if necessary. If a cable is damaged or does not move smoothly, have a Yamaha dealer check or replace it.

Recommended lubricant:
Engine oil

EWA10720

WARNING

Damage to the outer sheath may interfere with proper cable operation and will cause the inner cable to rust. Replace a damaged cable as soon as possible to prevent unsafe conditions.

Checking and lubricating the throttle grip and cable

EAU23111

The operation of the throttle grip should be checked before each ride. In addition, the cable should be lubricated at the intervals specified in the periodic maintenance chart.

Checking and lubricating the brake and shift pedals

EAU23131

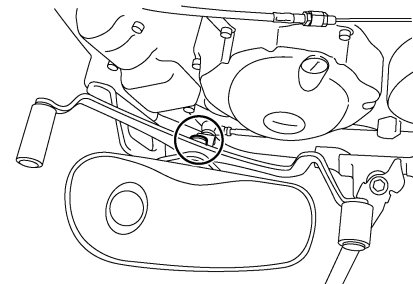
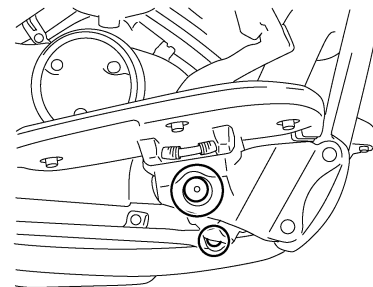

The operation of the brake and shift pedals should be checked before each ride, and the pedal pivots should be lubricated if necessary.

PERIODIC MAINTENANCE AND MINOR REPAIR

Recommended lubricant:

Lithium-soap-based grease (all-purpose grease)

Checking and lubricating the brake and clutch levers

EAU23140

Recommended lubricant:

Lithium-soap-based grease (all-purpose grease)

Brake lever

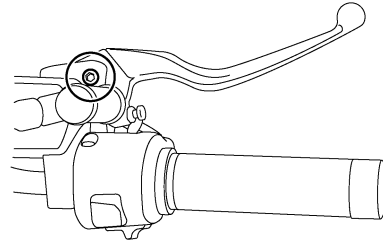

Clutch lever

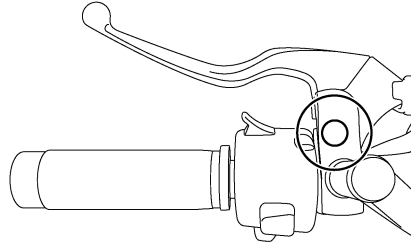

The operation of the brake and clutch levers should be checked before each ride, and the lever pivots should be lubricated if necessary.

PERIODIC MAINTENANCE AND MINOR REPAIR

Checking and lubricating the sidestand

EAU23200

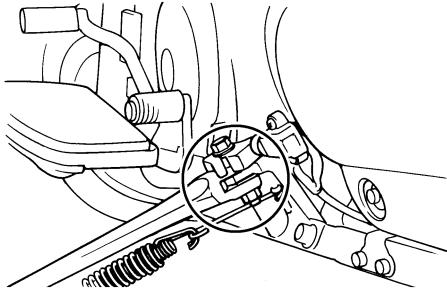

The operation of the sidestand should be checked before each ride, and the sidestand pivot and metal-to-metal contact surfaces should be lubricated if necessary.

EWA10730

WARNING

If the sidestand does not move up and down smoothly, have a Yamaha dealer check or repair it.

Recommended lubricant:

Lithium-soap-based grease (all-purpose grease)

Checking the front fork

EAU23271

The condition and operation of the front fork must be checked as follows at the intervals specified in the periodic maintenance and lubrication chart.

To check the condition

EWA10750

WARNING

Securely support the vehicle so that there is no danger of it falling over.

Check the inner tubes for scratches, damage and excessive oil leakage.

To check the operation

1. Place the vehicle on a level surface and hold it in an upright position.
2. While applying the front brake, push down hard on the handlebars several times to check if the front fork compresses and rebounds smoothly.

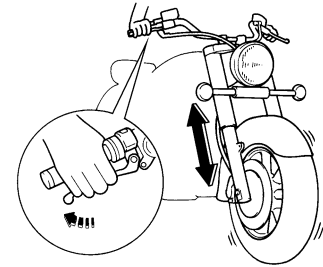

ECA10590

CAUTION:

If any damage is found or the front fork does not operate smoothly, have a Yamaha dealer check or repair it.

PERIODIC MAINTENANCE AND MINOR REPAIR

EAU23280

Checking the steering

Worn or loose steering bearings may cause danger. Therefore, the operation of the steering must be checked as follows at the intervals specified in the periodic maintenance and lubrication chart.

1. Place a stand under the engine to raise the front wheel off the ground.

EWA10750

WARNING

Securely support the vehicle so that there is no danger of it falling over.

2. Hold the lower ends of the front fork legs and try to move them forward and backward. If any free play can be felt, have a Yamaha dealer check or repair the steering.

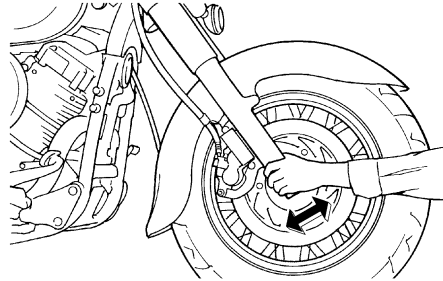

EAU23290

Checking the wheel bearings

The front and rear wheel bearings must be checked at the intervals specified in the periodic maintenance and lubrication chart. If there is play in the wheel hub or if the wheel does not turn smoothly, have a Yamaha dealer check the wheel bearings.

PERIODIC MAINTENANCE AND MINOR REPAIR

Battery

EAU23390

EWA10760

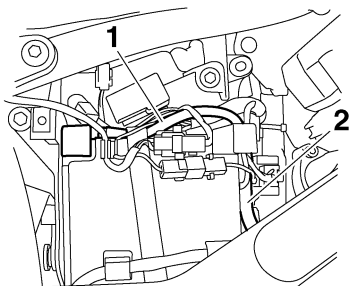

1. Positive battery lead (red)
2. Negative battery lead

The battery is located behind panel B. (See page 6-5.)

This model is equipped with a sealed-type (MF) battery, which does not require any maintenance. There is no need to check the electrolyte or to add distilled water.

To charge the battery

Have a Yamaha dealer charge the battery as soon as possible if it seems to have discharged. Keep in mind that the battery tends to discharge more quickly if the vehicle is equipped with optional electrical accessories.

! WARNING

- Electrolyte is poisonous and dangerous since it contains sulfuric acid, which causes severe burns. Avoid any contact with skin, eyes or clothing and always shield your eyes when working near batteries. In case of contact, administer the following **FIRST AID**.
 - **EXTERNAL:** Flush with plenty of water.
 - **INTERNAL:** Drink large quantities of water or milk and immediately call a physician.
 - **EYES:** Flush with water for 15 minutes and seek prompt medical attention.
- Batteries produce explosive hydrogen gas. Therefore, keep sparks, flames, cigarettes, etc., away from the battery and provide sufficient ventilation when charging it in an enclosed space.

- **KEEP THIS AND ALL BATTERIES OUT OF THE REACH OF CHILDREN.**

To store the battery

1. If the model will not be used for more than one month, remove the battery, fully charge it, and then place it in a cool, dry place.
2. If the battery will be stored for more than two months, check it at least once a month and fully charge it if necessary.
3. Fully charge the battery before installation.
4. After installation, make sure that the battery leads are properly connected to the battery terminals.

ECA10630

CAUTION:

- Always keep the battery charged. Storing a discharged battery can cause permanent battery damage.
- To charge a sealed-type (MF) battery, a special (constant-voltage) battery charger is required. Using a conventional battery

PERIODIC MAINTENANCE AND MINOR REPAIR

charger will damage the battery. If you do not have access to a sealed-type (MF) battery charger, have a Yamaha dealer charge your battery.

Replacing the fuses

EAU23524

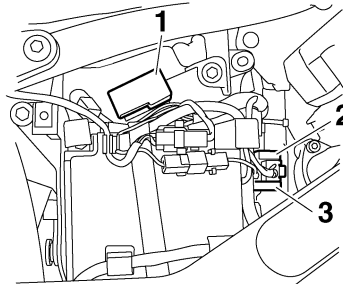

1. Fuse box
2. Main fuse
3. Spare main fuse

The main fuse and the fuse box, which contains the fuses for the individual circuits, are located behind panel B. (See page 6-5.)

If a fuse is blown, replace it as follows.

1. Turn the key to "OFF" and turn off the electrical circuit in question.
2. Remove the blown fuse, and then install a new fuse of the specified amperage.

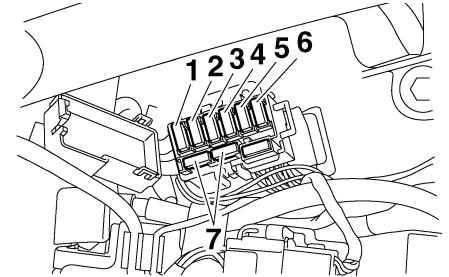

1. Headlight fuse
2. Signaling system fuse
3. Ignition fuse
4. Carburetor heater fuse
5. Parking lighting fuse (for XVS650A only)
6. Backup fuse (for odometer and immobilizer system) (for XVS650A only)
7. Spare fuse

PERIODIC MAINTENANCE AND MINOR REPAIR

Specified fuses:

- Main fuse:
30.0 A
- Signaling system fuse:
10.0 A
- Ignition fuse:
10.0 A
- Headlight fuse:
15.0 A
- Carburetor heater fuse:
15.0 A
- Backup fuse:
XVS650A 10.0 A
- Parking lighting fuse:
XVS650A 10.0 A

ECA10640

CAUTION:

Do not use a fuse of a higher amperage rating than recommended to avoid causing extensive damage to the electrical system and possibly a fire.

3. Turn the key to "ON" and turn on the electrical circuit in question to check if the device operates.
4. If the fuse immediately blows again, have a Yamaha dealer check the electrical system.

Replacing the headlight bulb

EAU23780

This model is equipped with a quartz bulb headlight. If the headlight bulb burns out, replace it as follows.

1. Remove the headlight unit by removing the screws.

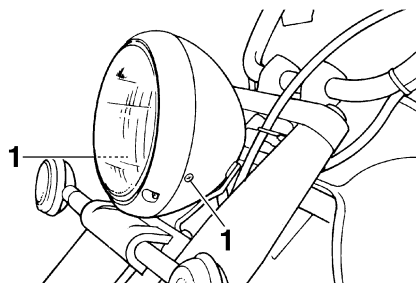

1. Screw

2. Disconnect the headlight coupler, and then remove the bulb cover.

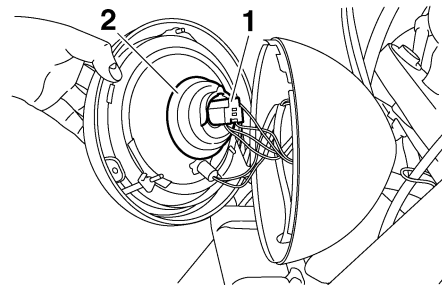

1. Headlight coupler
2. Headlight bulb cover

3. Remove the headlight bulb holder by turning it counterclockwise, and then remove the defective bulb.

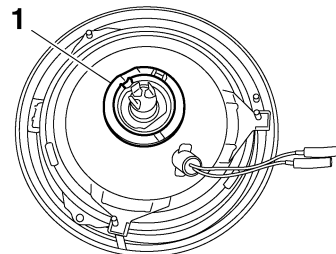

1. Headlight bulb holder

PERIODIC MAINTENANCE AND MINOR REPAIR

WARNING

EWA10790

Headlight bulbs get very hot. Therefore, keep flammable products away from a lit headlight bulb, and do not touch the bulb until it has cooled down.

4. Place a new headlight bulb into position, and then secure it with the bulb holder.

ECA10660

CAUTION:

Do not touch the glass part of the headlight bulb to keep it free from oil, otherwise the transparency of the glass, the luminosity of the bulb, and the bulb life will be adversely affected. Thoroughly clean off any dirt and fingerprints on the headlight bulb using a cloth moistened with alcohol or thinner.

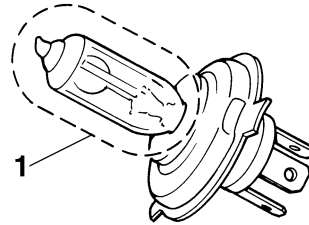

1. Do not touch the glass part of the bulb.
5. Install the headlight bulb cover, and then connect the coupler.
6. Install the headlight unit by installing the screws.
7. Have a Yamaha dealer adjust the headlight beam if necessary.

Replacing a turn signal light bulb or the tail/brake light bulb

EAU24281

1. Remove the lens by removing the screws.

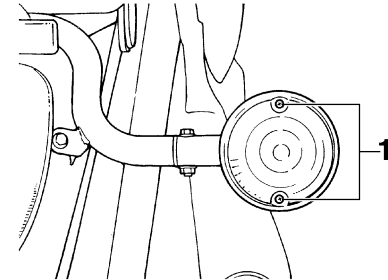

1. Screw

XVS650

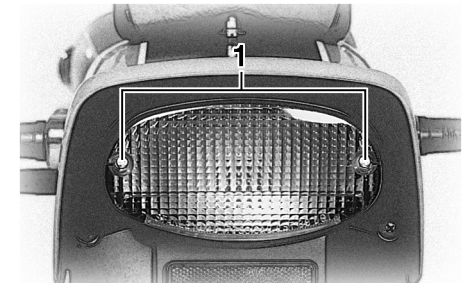

1. Screw

PERIODIC MAINTENANCE AND MINOR REPAIR

XVS650A

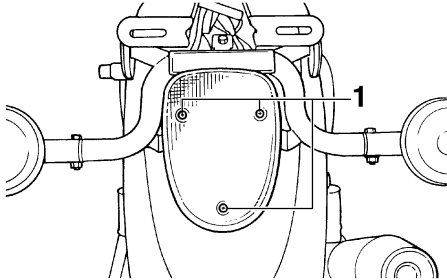

1. Screw

2. Remove the defective bulb by pushing it in and turning it counterclockwise.
3. Insert a new bulb into the socket, push it in, and then turn it clockwise until it stops.
4. Install the lens by installing the screws.

ECA10680

CAUTION:

Do not overtighten the screws, otherwise the lens may break.

Replacing the auxiliary light bulb (XVS650A)

EAU33411

If the auxiliary light bulb burns out, replace it as follows.

1. Remove the headlight unit by removing the screws.

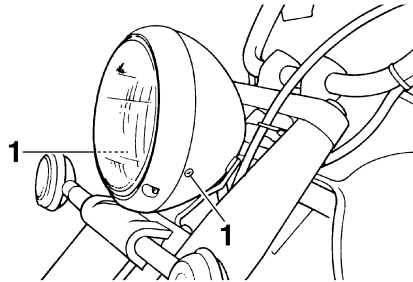

1. Screw

2. Remove the socket (together with the bulb) by pushing it in and turning it counterclockwise.

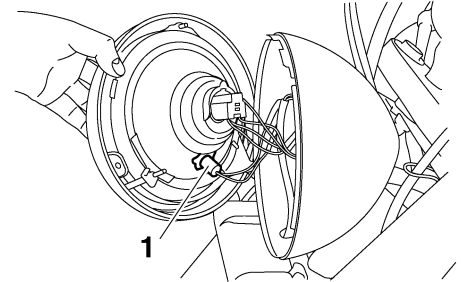

1. Auxiliary light bulb socket

3. Remove the defective bulb by pushing it in and turning it counterclockwise.
4. Insert a new bulb into the socket, push it in, and then turn it clockwise until it stops.
5. Install the socket (together with the bulb) by pushing it in and turning it clockwise until it stops.
6. Install the headlight unit by installing the screws.

PERIODIC MAINTENANCE AND MINOR REPAIR

Supporting the motorcycle

EAU24350

Since this model is not equipped with a centerstand, follow these precautions when removing the front and rear wheel or performing other maintenance requiring the motorcycle to stand upright. Check that the motorcycle is in a stable and level position before starting any maintenance. A strong wooden box can be placed under the engine for added stability.

To service the front wheel

1. Stabilize the rear of the motorcycle by using a motorcycle stand or, if an additional motorcycle stand is not available, by placing a jack under the frame in front of the rear wheel.
2. Raise the front wheel off the ground by using a motorcycle stand.

To service the rear wheel

Raise the rear wheel off the ground by using a motorcycle stand or, if a motorcycle stand is not available, by placing

a jack either under each side of the frame in front of the rear wheel or under each side of the swingarm.

Front wheel

EAU24360

To remove the front wheel

EAU24600

EWA10820

⚠ WARNING

- It is advisable to have a Yamaha dealer service the wheel.
- Securely support the motorcycle so that there is no danger of it falling over.

1. Disconnect the speedometer cable from the front wheel.

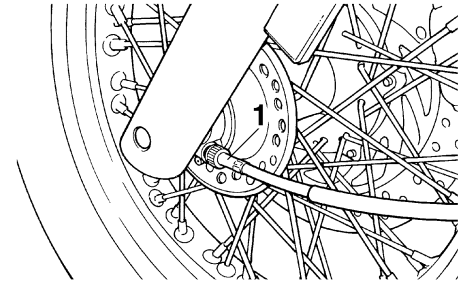

1. Speedometer cable

2. Loosen the front wheel axle pinch bolt, then the wheel axle.

PERIODIC MAINTENANCE AND MINOR REPAIR

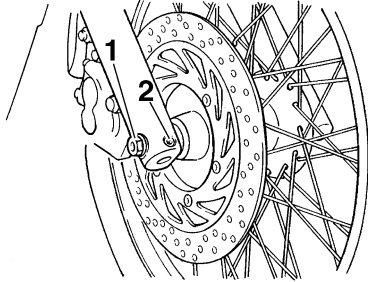

1. Wheel axle
2. Front wheel axle pinch bolt

3. Lift the front wheel off the ground according to the procedure on page 6-32.
4. Pull the wheel axle out, and then remove the wheel.

ECA11070

CAUTION:

Do not apply the brake after the wheel has been removed together with the brake disc, otherwise the brake pads will be forced shut.

EAU24932

To install the front wheel

1. Install the speedometer gear unit into the wheel hub so that the projections mesh with the slots.

2. Lift the wheel up between the fork legs.

NOTE:

Make sure that there is enough space between the brake pads before inserting the brake disc and that the slot in the speedometer gear unit fits over the retainer on the fork leg.

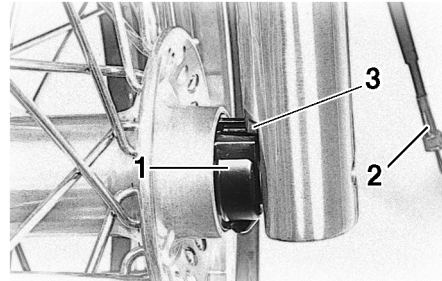

1. Speedometer gear unit
2. Speedometer cable
3. Retainer

3. Insert the wheel axle.
4. Lower the front wheel so that it is on the ground.
5. Tighten the wheel axle to the specified torque.

Tightening torque:

Wheel axle:
59 Nm (5.9 m-kgf, 43 ft-lbf)

6. Tighten the front wheel axle pinch bolt to the specified torque.

Tightening torque:

Front wheel axle pinch bolt:
20 Nm (2.0 m-kgf, 14 ft-lbf)

7. While applying the front brake, push down hard on the handlebars several times to check if the front fork compresses and rebounds smoothly.
8. Connect the speedometer cable.

PERIODIC MAINTENANCE AND MINOR REPAIR

Rear wheel

EAU25080

To remove the rear wheel

EAU25141

EWA10820

WARNING

- It is advisable to have a Yamaha dealer service the wheel.
- Securely support the motorcycle so that there is no danger of it falling over.

1. Loosen the axle nut.

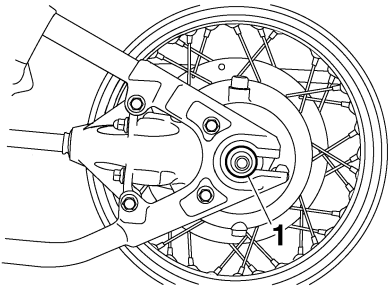

1. Axle nut

2. Disconnect the brake torque rod from the brake shoe plate by removing the bolt and nut.
3. Loosen the brake torque rod nut at the swingarm.

4. Remove the brake pedal free play adjusting nut, and then disconnect the brake rod from the brake camshaft lever.

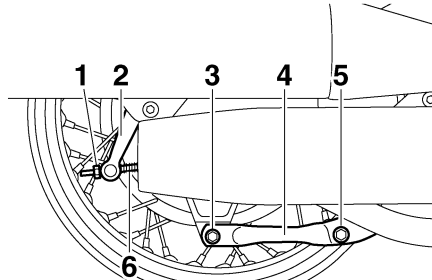

1. Brake pedal free play adjusting nut
2. Brake camshaft lever
3. Bolt and nut (shoe plate)
4. Brake torque rod
5. Bolt and nut (swingarm)
6. Brake rod

5. Remove panel A. (See page 6-5.)
6. Remove the bolts that secure the final gear case to the swingarm.

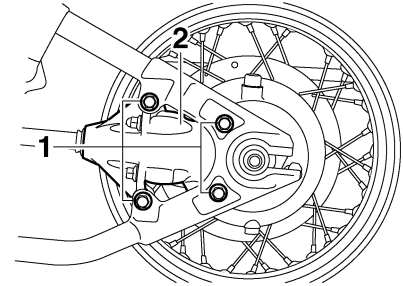

1. Bolt
2. Final gear case

7. Lift the rear wheel off the ground according to the procedure on page 6-32.
8. While supporting the drive shaft, pull the rear wheel back to remove the following parts as an assembly: wheel, wheel axle, final gear case, and drive shaft.

NOTE:

Make sure to support the drive shaft as it is being pulled out.

EAU25511

To install the rear wheel

1. Install the rear wheel, wheel axle, final gear case, and drive shaft by pushing the wheel forward and guiding the drive shaft into the middle gear universal joint.

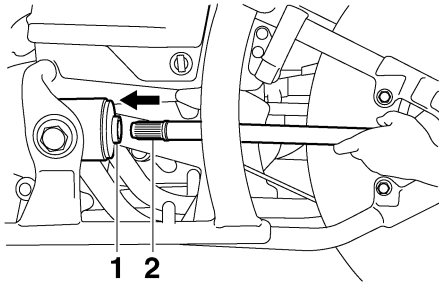

1. Middle gear universal joint
2. Drive shaft

2. Install the final gear case bolts.
3. Install the brake rod onto the brake camshaft lever, and then install the brake pedal free play adjusting nut onto the brake rod.
4. Install the brake torque rod bolt and nut at the brake shoe plate.
5. Install the panel.
6. Lower the rear wheel so that it is on the ground.

7. Tighten the axle nut, the final gear case bolts and the brake torque rod nuts to the specified torques.

Tightening torques:

Axle nut:

92 Nm (9.2 m·kgf, 67 ft·lbf)

Final gear case bolt:

74 Nm (7.4 m·kgf, 54 ft·lbf)

Brake torque rod nut:

20 Nm (2.0 m·kgf, 14 ft·lbf)

8. Adjust the brake pedal free play. (See page 6-19.)

EWA10660

WARNING

After adjusting the brake pedal free play, check the operation of the brake light.

EAU25850

Troubleshooting

Although Yamaha motorcycles receive a thorough inspection before shipment from the factory, trouble may occur during operation. Any problem in the fuel, compression, or ignition systems, for example, can cause poor starting and loss of power.

The following troubleshooting chart represents a quick and easy procedure for checking these vital systems yourself. However, should your motorcycle require any repair, take it to a Yamaha dealer, whose skilled technicians have the necessary tools, experience, and know-how to service the motorcycle properly.

Use only genuine Yamaha replacement parts. Imitation parts may look like Yamaha parts, but they are often inferior, have a shorter service life and can lead to expensive repair bills.

PERIODIC MAINTENANCE AND MINOR REPAIR

EAU25891

Troubleshooting chart

EWA10840



WARNING

Keep away open flames and do not smoke while checking or working on the fuel system.

1. Fuel

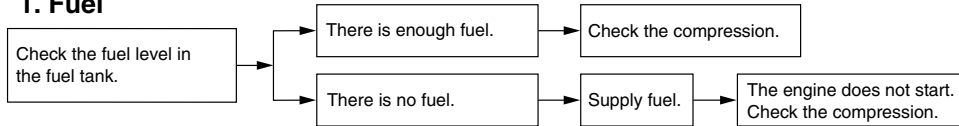

2. Compression

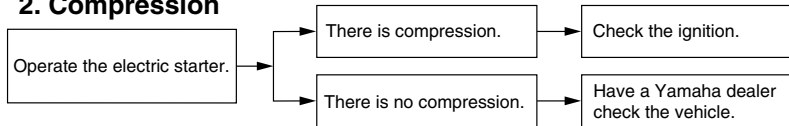

3. Ignition

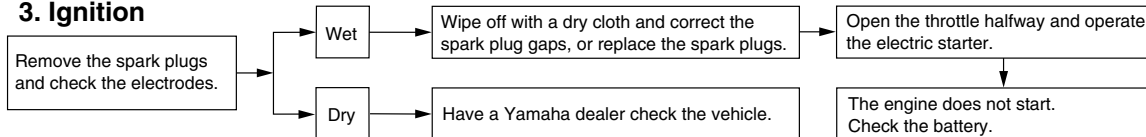

4. Battery

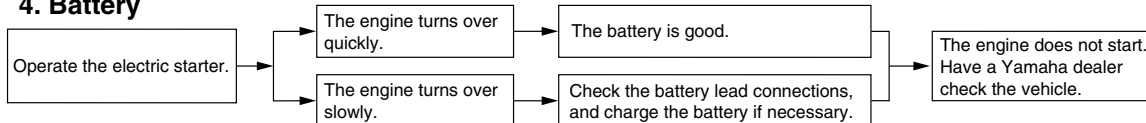

MOTORCYCLE CARE AND STORAGE

Care

While the open design of a motorcycle reveals the attractiveness of the technology, it also makes it more vulnerable. Rust and corrosion can develop even if high-quality components are used. A rusty exhaust pipe may go unnoticed on a car, however, it detracts from the overall appearance of a motorcycle. Frequent and proper care does not only comply with the terms of the warranty, but it will also keep your motorcycle looking good, extend its life and optimize its performance.

Before cleaning

1. Cover the muffler outlets with plastic bags after the engine has cooled down.
2. Make sure that all caps and covers as well as all electrical couplers and connectors, including the spark plug caps, are tightly installed.
3. Remove extremely stubborn dirt, like oil burnt onto the crankcase, with a degreasing agent and a brush, but never apply such prod-

EAU26060

Cleaning

CAUTION:

- **Avoid using strong acidic wheel cleaners, especially on spoked wheels. If such products are used on hard-to-remove dirt, do not leave the cleaner on the affected area any longer than instructed. Also, thoroughly rinse the area off with water, immediately dry it, and then apply a corrosion protection spray.**
- **Improper cleaning can damage windshields, cowlings, panels and other plastic parts. Use only a soft, clean cloth or sponge with mild detergent and water to clean plastic.**
- **Do not use any harsh chemical products on plastic parts. Be sure to avoid using cloths or sponges which have been in contact with strong or abrasive cleaning products, solvent or**

ucts onto seals, gaskets and wheel axles. Always rinse the dirt and degreaser off with water.

ECA10770

thinner, fuel (gasoline), rust removers or inhibitors, brake fluid, antifreeze or electrolyte.

- **Do not use high-pressure washers or steam-jet cleaners since they cause water seepage and deterioration in the following areas: seals (of wheel and swing-arm bearings, fork and brakes), electric components (couplers, connectors, instruments, switches and lights), breather hoses and vents.**
- **For motorcycles equipped with a windshield: Do not use strong cleaners or hard sponges as they will cause dulling or scratching. Some cleaning compounds for plastic may leave scratches on the windshield. Test the product on a small hidden part of the windshield to make sure that it does not leave any marks. If the windshield is scratched, use a quality plastic polishing compound after washing.**

MOTORCYCLE CARE AND STORAGE

After normal use

Remove dirt with warm water, a mild detergent, and a soft, clean sponge, and then rinse thoroughly with clean water. Use a toothbrush or bottlebrush for hard-to-reach areas. Stubborn dirt and insects will come off more easily if the area is covered with a wet cloth for a few minutes before cleaning.

After riding in the rain, near the sea or on salt-sprayed roads

Since sea salt or salt sprayed on roads during winter are extremely corrosive in combination with water, carry out the following steps after each ride in the rain, near the sea or on salt-sprayed roads.

NOTE:

Salt sprayed on roads in the winter may remain well into spring.

1. Clean the motorcycle with cold water and a mild detergent, after the engine has cooled down.

ECA10790

CAUTION:

Do not use warm water since it increases the corrosive action of the salt.

2. After drying the motorcycle, apply a corrosion protection spray on all metal, including chrome- and nickel-plated, surfaces to prevent corrosion.

After cleaning

1. Dry the motorcycle with a chamois or an absorbing cloth.
2. Use a chrome polish to shine chrome, aluminum and stainless-steel parts, including the exhaust system. (Even the thermally induced discoloring of stainless-steel exhaust systems can be removed through polishing.)
3. To prevent corrosion, it is recommended to apply a corrosion protection spray on all metal, including chrome- and nickel-plated, surfaces.
4. Use spray oil as a universal cleaner to remove any remaining dirt.

5. Touch up minor paint damage caused by stones, etc.
6. Wax all painted surfaces.
7. Let the motorcycle dry completely before storing or covering it.

EWA11130

! WARNING

- **Make sure that there is no oil or wax on the brakes or tires.**
- **If necessary, clean the brake discs and brake linings with a regular brake disc cleaner or acetone, and wash the tires with warm water and a mild detergent. Before riding at higher speeds, test the motorcycle's braking performance and cornering behavior.**

ECA10800

CAUTION:

- **Apply spray oil and wax sparingly and make sure to wipe off any excess.**
- **Never apply oil or wax to any rubber and plastic parts, but treat them with a suitable care product.**

MOTORCYCLE CARE AND STORAGE

- **Avoid using abrasive polishing compounds as they will wear away the paint.**

NOTE: _____
Consult a Yamaha dealer for advice on what products to use.

Storage

Short-term

Always store your motorcycle in a cool, dry place and, if necessary, protect it against dust with a porous cover.

CAUTION:

- **Storing the motorcycle in a poorly ventilated room or covering it with a tarp, while it is still wet, will allow water and humidity to seep in and cause rust.**
- **To prevent corrosion, avoid damp cellars, stables (because of the presence of ammonia) and areas where strong chemicals are stored.**

Long-term

Before storing your motorcycle for several months:

1. Follow all the instructions in the “Care” section of this chapter.
2. For motorcycles equipped with a fuel cock that has an “OFF” position: Turn the fuel cock lever to “OFF”.

EAU26230

ECA10810

3. Drain the carburetor float chambers by loosening the drain bolts; this will prevent fuel deposits from building up. Pour the drained fuel into the fuel tank.
4. Fill up the fuel tank and add fuel stabilizer (if available) to prevent the fuel tank from rusting and the fuel from deteriorating.
5. Perform the following steps to protect the cylinders, piston rings, etc. from corrosion.
 - a. Remove the spark plug caps and spark plugs.
 - b. Pour a teaspoonful of engine oil into each spark plug bore.
 - c. Install the spark plug caps onto the spark plugs, and then place the spark plugs on the cylinder head so that the electrodes are grounded. (This will limit sparking during the next step.)
 - d. Turn the engine over several times with the starter. (This will coat the cylinder walls with oil.)
 - e. Remove the spark plug caps from the spark plugs, and then install the spark plugs and the spark plug caps.

MOTORCYCLE CARE AND STORAGE

WARNING

EWA10950

To prevent damage or injury from sparking, make sure to ground the spark plug electrodes while turning the engine over.

6. Lubricate all control cables and the pivoting points of all levers and pedals as well as of the side-stand/centerstand.
7. Check and, if necessary, correct the tire air pressure, and then lift the motorcycle so that both of its wheels are off the ground. Alternatively, turn the wheels a little every month in order to prevent the tires from becoming degraded in one spot.
8. Cover the muffler outlets with plastic bags to prevent moisture from entering them.
9. Remove the battery and fully charge it. Store it in a cool, dry place and charge it once a month. Do not store the battery in an excessively cold or warm place [less than 0 °C (30 °F) or more than 30

°C (90 °F)]. For more information on storing the battery, see page 6-27.

NOTE: _____
Make any necessary repairs before storing the motorcycle.

Dimensions:

Overall length:

- XVS650 2340 mm (92.1 in)
- XVS650A 2450 mm (96.5 in)

Overall width:

- XVS650 880 mm (34.6 in)
- XVS650A 930 mm (36.6 in)

Overall height:

- XVS650 1070 mm (42.1 in)
- XVS650A 1105 mm (43.5 in)

Seat height:

- XVS650 695 mm (27.4 in)
- XVS650A 710 mm (28.0 in)

Wheelbase:

- XVS650 1610 mm (63.4 in)
- XVS650A 1625 mm (64.0 in)

Ground clearance:

- 140 mm (5.51 in)

Minimum turning radius:

- XVS650 3100 mm (122.0 in)
- XVS650A 3400 mm (133.9 in)

Weight:

With oil and fuel:

- XVS650 233.0 kg (514 lb)
- XVS650A 247.0 kg (545 lb)

Engine:

Engine type:

- Air cooled 4-stroke, SOHC

Cylinder arrangement:

- V-type 2-cylinder

Displacement:

- 649.0 cm³ (39.60 cu.in)

Bore × stroke:

- 81.0 × 63.0 mm (3.19 × 2.48 in)

Compression ratio:

- 9.00 :1

Starting system:

- Electric starter

Lubrication system:

- Wet sump

Engine oil:

Type:

- SAE10W30 or SAE10W40 or SAE15W40
or SAE20W40 or SAE20W50

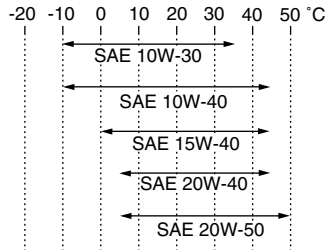

Recommended engine oil grade:

- API service SE, SF, SG type or higher

Engine oil quantity:

- Without oil filter element replacement:
2.60 L (2.75 US qt) (2.29 Imp.qt)
- With oil filter element replacement:
2.80 L (2.96 US qt) (2.46 Imp.qt)

Final gear oil:

Type:

- SAE80 API GL-4 Hypoid gear oil

Quantity:

- 0.19 L (0.20 US qt) (0.17 Imp.qt)

Air filter:

Air filter element:

- Dry element

Fuel:

Recommended fuel:

- Unleaded gasoline only

Fuel tank capacity:

- 16.0 L (4.23 US gal) (3.52 Imp.gal)

Fuel reserve amount:

- 3.0 L (0.79 US gal) (0.66 Imp.gal)

Carburetor:

Manufacturer:

- MIKUNI

Type × quantity:

- BDS28 x 2

Spark plug (s):

Manufacturer/model:

- NGK/DPR7EA-9

Manufacturer/model:

- DENSO/X22EPR-U9

Spark plug gap:

- 0.8–0.9 mm (0.031–0.035 in)

Clutch:

Clutch type:

- Wet, multiple-disc

Transmission:

Primary reduction system:

- Spur gear

Primary reduction ratio:

- 68/38 (1.789)

Secondary reduction system:

- Shaft drive

Secondary reduction ratio:

- 19/18 × 32/11 (3.071)

SPECIFICATIONS

Transmission type:
Constant mesh 5-speed

Operation:
Left foot operation

Gear ratio:
1st:
38/14 (2.714)
2nd:
38/20 (1.900)
3rd:
35/24 (1.458)
4th:
28/24 (1.167)
5th:
29/30 (0.967)

Chassis:

Frame type:
Double cradle
Caster angle:
35.00 °

Trail:
XVS650 153.0 mm (6.02 in)
XVS650A 145.0 mm (5.71 in)

Front tire:

Type:
With tube
Size:
XVS650 100/90-19M/C 57S
XVS650A 130/90-16M/C 67S

Manufacturer/model:
XVS650 BRIDGESTONE/EXEDRA L309
XVS650A BRIDGESTONE/EXEDRA
G703

Manufacturer/model:
XVS650 DUNLOP/F24
XVS650A DUNLOP/D404F

Rear tire:

Type:
With tube
Size:
170/80-15M/C 77S
Manufacturer/model:
XVS650 BRIDGESTONE/EXEDRA G546
XVS650A BRIDGESTONE/EXEDRA
G702

Manufacturer/model:
XVS650 DUNLOP/K555
XVS650A DUNLOP/D404G

Loading:

Maximum load:
XVS650 180 kg (397 lb)
XVS650A 200 kg (441 lb)
(Total weight of rider, passenger, cargo and accessories)

Tire air pressure (measured on cold tires):

Loading condition:
0–90 kg (0–198 lb)
Front:
XVS650 200 kPa (29 psi) (2.00 kgf/cm²)
XVS650A 225 kPa (33 psi) (2.25 kgf/cm²)
Rear:
225 kPa (33 psi) (2.25 kgf/cm²)
Loading condition:
XVS650 90–180 kg (198–397 lb)
XVS650A 90–200 kg (198–441 lb)

Front:
XVS650 200 kPa (29 psi) (2.00 kgf/cm²)
XVS650A 225 kPa (33 psi) (2.25 kgf/cm²)

Rear:
250 kPa (36 psi) (2.50 kgf/cm²)

Front wheel:

Wheel type:
Spoke wheel
Rim size:
XVS650 19M/C x MT2.50
XVS650A 16M/C x MT3.00

Rear wheel:

Wheel type:
Spoke wheel
Rim size:
15M/C x MT3.50

Front brake:

Type:
Single disc brake
Operation:
Right hand operation
Recommended fluid:
DOT 4

Rear brake:

Type:
Drum brake
Operation:
Right foot operation

Front suspension:

Type:
Telescopic fork
Spring/shock absorber type:
Coil spring/oil damper

Wheel travel:
140.0 mm (5.51 in)

Rear suspension:

Type:
Swingarm (monocross)
Spring/shock absorber type:
Coil spring/gas-oil damper
Wheel travel:
XVS650 86.0 mm (3.39 in)
XVS650A 98.0 mm (3.86 in)

Electrical system:

Ignition system:
Transistorized coil ignition (digital)
Charging system:
AC magneto

Battery:

Model:
GT12B-4
Voltage, capacity:
12 V, 10.0 Ah

Headlight:

Bulb type:
Halogen bulb

Bulb voltage, wattage × quantity:

Headlight:
12 V, 60 W/55.0 W × 1
Tail/brake light:
12 V, 5.0 W/21.0 W × 1
Front turn signal light:
12 V, 21.0 W × 2
Rear turn signal light:
12 V, 21.0 W × 2
Auxiliary light:
XVS650A 12 V, 4.0 W × 1

Meter lighting:
12 V, 1.7 W × 1
Neutral indicator light:
12 V, 1.7 W × 1
High beam indicator light:
12 V, 1.7 W × 1
Turn signal indicator light:
12 V, 1.7 W × 1
Engine trouble warning light:
12 V, 1.7 W × 1
Immobilizer system indicator light:
XVS650A LED

Fuses:

Main fuse:
30.0 A
Headlight fuse:
15.0 A
Signaling system fuse:
10.0 A
Ignition fuse:
10.0 A
Parking lighting fuse:
XVS650A 10.0 A
Carburetor heater fuse:
15.0 A
Backup fuse:
XVS650A 10.0 A

CONSUMER INFORMATION

Identification numbers

Record the key identification number, vehicle identification number and model label information in the spaces provided below for assistance when ordering spare parts from a Yamaha dealer or for reference in case the vehicle is stolen.

KEY IDENTIFICATION NUMBER:

VEHICLE IDENTIFICATION NUMBER:

MODEL LABEL INFORMATION:

<input type="radio"/>
<input type="radio"/>

EAU26351

Key identification number

XVS650

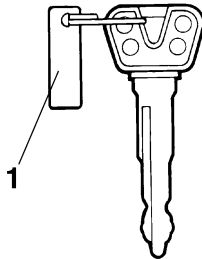

1. Key identification number

XVS650A

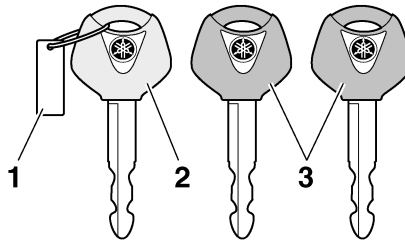

1. Key identification number
2. Code re-registering key (red bow)
3. Standard keys (black bow)

EAU26381

The key identification number is stamped into the key tag. Record this number in the space provided and use it for reference when ordering a new key.

EAU26400

Vehicle identification number

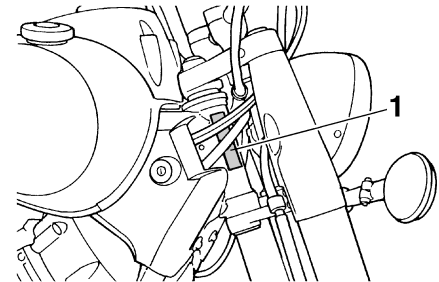

1. Vehicle identification number

The vehicle identification number is stamped into the steering head pipe. Record this number in the space provided.

NOTE: _____

The vehicle identification number is used to identify your motorcycle and may be used to register your motorcycle with the licensing authority in your area.

Model label

EAU26470

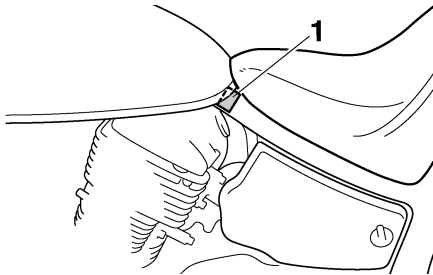

1. Model label

The model label is affixed to the frame under the rider seat. (See page 3-11.) Record the information on this label in the space provided. This information will be needed when ordering spare parts from a Yamaha dealer.

EAU26570

**Motorcycle noise regulation
(for Australia)**

TAMPERING WITH NOISE CONTROL SYSTEM PROHIBITED:

Owners are warned that the law may prohibit:

- a. The removal or rendering inoperative by any person other than for purposes of maintenance, repair or replacement, of any device or element of design incorporated into any new vehicle for the purpose of noise control prior to its sale or delivery to the ultimate purchaser or while it is in use; and
- b. The use of the vehicle after such device or element of design has been removed or rendered inoperative by any person.

INDEX

A

- Air filter element, cleaning..... 6-11
- Auxiliary light bulb, replacing (XVS650A)..... 6-31

B

- Battery..... 6-27
- Brake and clutch levers, checking and lubricating 6-24
- Brake and shift pedals, checking and lubricating 6-23
- Brake fluid, changing 6-22
- Brake fluid level, checking 6-21
- Brake lever 3-8
- Brake lever free play, adjusting..... 6-18
- Brake pads and shoes, checking 6-21
- Brake pedal..... 3-8
- Brake pedal position and free play, adjusting 6-19

C

- Cables, checking and lubricating 6-23
- Carburetors, adjusting..... 6-13
- Care 7-1
- Clutch lever..... 3-7
- Clutch lever free play, adjusting..... 6-17

D

- Dimmer switch 3-6

E

- Engine break-in..... 5-4
- Engine idling speed..... 6-13
- Engine oil and oil filter element..... 6-7
- Engine, starting a warm 5-2
- Engine stop switch 3-6
- Engine trouble warning light..... 3-4

F

- Final gear oil 6-10
- Front fork, checking..... 6-25
- Fuel..... 3-9
- Fuel cock 3-10
- Fuel consumption, tips for reducing..... 5-4
- Fuel tank cap 3-8
- Fuses, replacing 6-28

H

- Handlebar switches 3-5
- Hazard switch (XVS650A) 3-6
- Headlight bulb, replacing..... 6-29
- Helmet holder 3-14
- High beam indicator light..... 3-4
- Horn switch..... 3-6

I

- Identification numbers 9-1
- Ignition circuit cut-off system 3-17
- Immobilizer system indicator light (XVS650A) 3-4
- Immobilizer system (XVS650A)..... 3-1
- Indicator and warning lights..... 3-4

K

- Key identification number 9-1

L

- Labels, location of..... 1-5
- Luggage strap holders..... 3-16

M

- Main switch/steering lock (XVS650) 3-2
- Main switch/steering lock (XVS650A)..... 3-2
- Model label 9-2

N

- Neutral indicator light..... 3-4
- Noise regulation (for Australia) 9-2

P

- Panels, removing and installing 6-5
- Parking..... 5-5
- Part locations 2-1
- Pass switch 3-6
- Periodic maintenance and lubrication chart..... 6-2
- Pre-operation check list..... 4-2

R

- Rear brake light switch, adjusting 6-20

S

- Safety information 1-1
- Seats (XVS650) 3-11
- Seats (XVS650A) 3-12
- Shifting 5-3
- Shift pedal (XVS650)..... 3-7
- Shift pedal (XVS650A) 3-7
- Shock absorber assembly, adjusting 3-15
- Sidestand 3-16
- Sidestand, checking and lubricating..... 6-25
- Spark plugs, checking 6-6
- Specifications 8-1
- Speedometer unit..... 3-5
- Starter (choke) knob..... 3-11
- Starting and warming up a cold engine 5-1
- Start switch..... 3-6
- Steering, checking..... 6-26
- Storage..... 7-3
- Storage compartment..... 3-14
- Supporting the motorcycle 6-32

T

- Throttle cable free play, checking 6-14

Throttle grip and cable, checking and lubricating	6-23
Tires.....	6-14
Tool kit.....	6-1
Troubleshooting.....	6-35
Troubleshooting chart.....	6-36
Turn signal indicator light.....	3-4
Turn signal light bulb or tail/brake light bulb, replacing.....	6-30
Turn signal switch.....	3-6

V

Valve clearance	6-14
Vehicle identification number.....	9-1

W

Wheel bearings, checking	6-26
Wheel (front).....	6-32
Wheel (rear).....	6-34
Wheels.....	6-17



PRINTED ON RECYCLED PAPER

PRINTED IN JAPAN
2005.05-0.3×1 CR
(E)